

incider

USA \$2.95/Canada \$3.95
May 1986
A CWC/I PUBLICATION

TELECOMMUNICATIONS



"The Dow Jones Service is much more efficient than trying to read The Wall Street Journal every day."

MONEY



"For my personal use, I use the Official Airlines Guide to find low-cost airfares."

TRAVEL

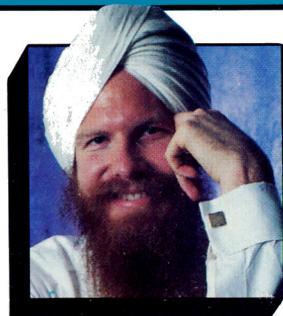

"With Sikhnet, we keep up with the latest teachings on Yoga and meditation."

EDUCATION



"If you're hunting for a job, going on line can be a good."

JOBS



"It's easy to become real close friends with the people you talk to on line."

LOVE





Why The Biggest Names In Software AST's SprintDisk™ Memory

AST and leading software manufacturers are working together to break new ground, establish new standards and provide new solutions that enhance the power of your Apple II for your serious business and educational needs.

In making their hardware compatibility choices — choices that can make or break their companies — the

*The most current versions

SprintDisk, SprintCache trademarks and SixPakPlus registered trademark of AST Research, Inc. Apple registered trademark and Apple II, Macintosh, AppleWriter II, AppleWorks and ProDOS trademarks of Apple Computer, Inc. BusinessWorks is a trademark of Manzanita Software Systems. MouseWrite is a trademark of Roger Wagner Publishing, Inc. Dollars and Sense is a trademark of Monogram. BPI and BPI Systems are trademarks of BPI Systems, Inc. Sensible Speller is a trademark of Sensible Software, Inc. Mouse Calc and Mouse Desk are trademarks of Version Software. SuperCalc 'a is a registered trademark of Sorcim/IUS Micro Software. A Division of Computer Associates International, Inc. PFS: Write, PFS: Plan, PFS: Report, PFS: File and PFS: Graph are registered trademarks of Software Publishing Corporation. Catalyst is a trademark of Quark Incorporated. ReportWorks registered trademark of Megahouse Corporation. Pinpoint is a trademark of Pinpoint Publishing and Virtual Combinatics, Inc. Managing Your Money registered trademark of Micro Education Corporation of America.
Copyright ©1986 AST Research, Inc. All rights reserved.

software leaders look to AST, the hardware leader with the proven track record. So should you.

AST is the world's leading supplier of enhancement products for personal computers with a well-earned reputation for outstanding quality and reliability. We offer a full-line of products for the Apple II and Macintosh™ families. And you've heard of our award-winning SixPakPlus® multi-function card for the IBM PC — the defacto industry standard with well over 500,000 shipped.

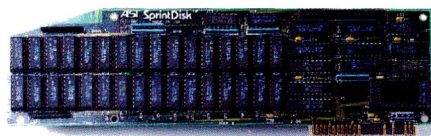

**Introducing SprintDisk:
Up To 2 MB Of Memory
Expansion And All The
Software Compatibility,
With None Of The
Modifications.**

The new generation memory card is here, now you can break the 64K barrier with all the software compatibility you need. Designed for use as a rapid-access, mass-storage device, SprintDisk provides up to 2 Megabytes of desktop workspace for your spreadsheets, word processing documents and databases.

Good-bye Software Patches.
With SprintDisk you can take advantage of expanded memory while saying "good-bye" to the hassles of modi-



ware Are 100% Compatible With Expansion For The Apple II.™

fications. All your favorite applications software* (those illustrated above and more) are completely, automatically and immediately compatible. Of course, SprintDisk is ProDOS,™ DOS 3.3 and Pascal 1.3 compatible.

The Speed of AST's SprintCache™ Buffer. We include exclusive utility software – we call it SprintCache – so if you are using multiple storage devices, you can also use SprintDisk as a caching buffer. It allows you to cache up to fourteen floppy, hard-disk or tape drives for higher performance and greater productivity.

Hardware Facts. SprintDisk is compatible with the Apple II Memory



Expansion board. It's fully socketed and user-upgradeable with 256 Kb chips. And it comes with its own RAM diagnostic software.

The Quality, Service and Support of an Industry Leader. AST's worldwide reputation is built on quality. SprintDisk features the highest-quality four-layer construction and undergoes extensive testing and comprehensive burn-in procedures for the ultimate in reliability – AST has the lowest product failure rate in the industry. And don't forget our two-year warranty, world-renowned service and customer support.

For more information call (714) 476-3866 or circle the reader service below.

FEATURES

SprintDisk

- Up to 2 MB Total Memory
 - 256 Kb to 1.0 MB on mainboard
 - Up to 1.0 MB additional memory on piggyback card
- Apple II Memory Expansion board compatible
- SprintCache for fast, user-transparent disk/tape caching
- ProDOS, DOS 3.3 and Pascal 1.3 compatible
- No application software modifications necessary
- Fits any I/O slot except #3 in II, II+ or IIe
- Fully socketed and user-upgradeable

AST
RESEARCH INC.



A computer store's service at mail-order prices.

Because we're both.

Our commitment to service is why so many private individuals, schools and Fortune 1000 companies choose Micro City. If in the Chicago area, please visit our retail store at 24 W500 Maple Ave., Naperville, IL 60540,



DISKETTES

GENERIC
Top Quality DS DD, 100% Certified, With Sleeve & Hub Ring, Each .95¢
VERBATIM
SS DD Box of 10 17.00
Disk Drive Head Cleaning Kit 8.95
Cleaning Diskettes—10 12.00
3½" SS DD Box of 10 26.95

DISK DRIVES

MITSUBA
Super 5 Direct Slim Drive, II+, //e (Year Warranty) 145.00
Super 5 Direct Slim Drive, //c (Year Warranty) 149.00
Super 5 Drive for Macintosh (Year Warranty) 249.00
Disk Drive Controller for 2 Drives, II+, //e 45.00

PACE
AP-50 Full Height, Shugart Mechanism, II+, //e 135.00
GENERIC HARDWARE
ALL WITH 90 DAY WARRANTY, 14 DAY SATISFACTION GUARANTEE
16K Ram Card, II+ 39.00
Z-80 Card for II+, //e (Hardware Only) 42.00

Cooling Fan, 2 Outlets, Surge Protection, II+, //e 29.00
Replacement Keyboard, II+ 69.00
Computer Case, II+ 59.00
Case with Built-in Numeric Keypad, II+ 119.00
RF Modulator 19.00
Power Strip with Surge Protection, 6 Outlets 19.00

MISCELLANEOUS HARDWARE

ADVANCED LOGIC SYSTEMS
Z Engine (Z-80 with Software), II+, //e 129.00
AST
Multifunction Board (2 Serial Ports, Clock/Cal) 149.00

CH PRODUCTS
Mach II Joystick II+ 38.00
Mach II Joystick, //e 38.00
Mach III Joystick with Firebutton, II+ 45.00
Mach III Joystick with Firebutton, //e 45.00
Paddlestick, II+ 45.00
Paddlestick, //e 45.00

CHECKMATE TECHNOLOGY
MultiRam //e 64K 129.00
MultiRam //e 192K 149.00
MultiRam //e 256K 169.00
MultiRam //e 512K 199.00
MultiRam //e 768K 219.00
MultiRam CX 256K 239.00
MultiRam CX 512K 269.00
MultiRam CX with 16 Bit Installed, 256K 339.00
MultiRam CX with 16 Bit Installed, 512K 369.00

KENSINGTON MICROWARE
System Saver Fan, II+, //e 65.00
KOALA TECHNOLOGIES
Koala Pad Plus with Software, //e, //c 69.00

Adapter to use Koala Pad with II+ (by Suncom) 5.95
Gibson Light Pen 149.00
MacVision Digitizer for Mac 179.00
MacKAT for Mac 149.00
MICROTEK
Magnum 80 me, 80 Col., 64K //e 99.00
Dumpling GX Graphics Printer Interface, II+, //e 79.00

MITSUBA
80 Col, 64K, //e 89.00
MOUSE SYSTEMS
A+ Mouse for //c, Mac (Optical Mouse) 89.00
N-2 Parallel A-B Switchbox 59.00
ORANGE MICRO
Grappler + Graphics Printer Interface, II+, //e 89.00
Buffered Grappler +, 16K 149.00
Grappler C for //c 99.00

PRACTICAL PERIPHERALS
WITH 5 YEAR WARRANTY
GraphiCard, Graphics Printer Interface, II+, //e 79.00
PrinterFace Printer Interface, II+, //e 59.00
Serial, For Modem or Printer, II+, //e 109.00
Switchport //c, Serial to Parallel Converter 89.00

MICROBUFFER II+ Printer Interface Cards, II+, //e—includes both serial and parallel cables. Provides excellent buffer capability.
16K 135.00
32K 145.00
64K 165.00
Pro Clock, II+, //e 109.00
Pro Clock, //c 109.00

Microbuffer In-Line External Buffer
32K (Specify Parallel or Serial) 189.00
64K (Specify Parallel or Serial) 219.00
128K (Specify Parallel or Serial) 259.00
256K (Specify Parallel or Serial) 289.00

Microbuffer/Epson (Buffer Mounts Inside Epson Printers)
16K Parallel 115.00
32K Parallel 135.00
64K Parallel 175.00
8K Serial 115.00
16K Serial 125.00
32K Serial 145.00

QUADRAM
eRam 80, 80 Col., 64K, //e 109.00
MultiCore w/No Memory, II+, //e 179.00
MultiCore w/256K 299.00
Ext. Multifunction Card for II+, //e 189.00
Pro Dos Clock/Cal, II+, //e 75.00

SUNCOM
//e, II+ Joystick Adapter 5.95
SWEET MICRO
Mockingboard A Music Synthesizer 89.00

Mockingboard B Speech Upgrade 79.00
Mockingboard C Music + Speech 139.00
Mockingboard D for //c 149.00
TITAN
64K Ram Card, II+, //e 159.00
128K Ram Card, II+, //e 199.00
Accelerator //e, II+, //e 219.00

VIDEO 7
Color Enhancer //e (RGB Adapter) 132.00
Color Enhancer //c (RGB Adapter) 99.00
Amdek AC-1100 Cable (Connects Video 7 Color Enhancer //e or //c to IBM Compatible RGB Monitor) 15.95
Slot 7 RGB Adapter for II+ 119.00

MODEMS
HAYES
Smartmodem 300 (External Modem) 145.00
Smartmodem 1200 (External Modem) 385.00
Smartmodem 2400 (External Modem) 619.00
Micromodem //e with Software 145.00
Smartmodem 300 with Software 165.00

NOVATION
Apple CAT II with Software, II+, //e (300 Baud) 187.00
212 Apple CAT Upgrade 217.00
212 Apple Cat System (1200 Baud) 349.00
Expansion Module for Apple Cat 29.95
Smart Cat Plus 1200 Baud with Software, Mac 299.00
2400 Professional Modem with Software, Mac 519.00
J-CAT 89.00

PROMETHEUS
Promodem 1200 External 289.00
Promodem 1200A with Software, II+, //e 259.00
Transportable Modem //c with Software (300 Baud) 139.00

MONITORS
C-ITOH
CM-1000 RGB & Composite, Green Switch 359.00
Cable for Apple II+, //e 27.00
ZENITH
ZVM-1220 Amber 109.00
ZVM-1230 Green 109.00

PRINTERS
EPSON
LX-80 229.00
Tractor for LX-80 29.95
LX-90 with PIC for //c 289.00
LQ-800 595.00
LQ-1000 729.00
FX-85 399.00
FX-286 599.00
JX-80 Color Printer 329.00
DX-10 Daisy Wheel 239.00

Publisher Terri Hamilton
Editor in Chief Deborah de Peyster
Managing Editor Dawn F. Matthews
Senior Editor Eileen T. Terrill
Technical Editor Paul Statt
Assistant Editor Lafe Low
Proofreader Peter Bjornsen
West Coast Editor Wendy Lea McKibbin (415) 328-3470
Field Editor Babs Cringely

Advertising

Sales Manager/Northeast Paul Boulé (800) 441-4403
Sales Representative (603) 924-7138
Southeast and Central Sales Representative Fiona Davies (800) 441-4403
Sales Manager/Northwest Donna Pomponi 1060 Marsh Road Menlo Park, CA 94025 (415) 328-3470 (800) 344-4636 in CA
Sales Manager/Southwest Sanford L. Fish 1060 Marsh Road Menlo Park, CA 94025 (415) 328-3470 (800) 344-4636 in CA
Advertising Coordinator Kim Labbe (800) 441-4403

Marketing Services Manager Michael Duran

Design

Art Director Donna Wohlfarth
Production Supervisor Phyllis Pittet
Ad/Graphics Production Rosemary Gibson
Graphic Services
Graphic Services Manager Dennis Christensen
Manufacturing Manager Susan Gross
Typesetting Supervisor Linda P. Canale
Typesetter Nancy Salwen

CW Communications/Peterborough

President/CEO James S. Povec
Vice President/Finance Roger Murphy
Assistant General Manager Matt Smith
V.P. of Planning and Circulation William P. Howard
Circulation Manager Frank S. Smith
Direct & Newsstand Sales Manager Raino Wirein (800) 343-0728
Director of Credit, Sales, and Collection William M. Boyer
Executive Creative Director Christine Destrempe
Founder Wayne Green

inCider's BBS (bulletin-board system)
On line 24 hours: (603) 924-9801

inCider (ISSN #0740-0101) is published monthly by CW Communications/Peterborough, Inc., 80 Pine Street, Peterborough, NH 03458. Phone: (603) 924-9471. Second-class postage paid at Peterborough, NH, and additional mailing offices. (Canadian second class mail registration number 9590.) Subscription rates in U.S. are \$24.97 for one year, \$38.00 for two years and \$53.00 for three years. In Canada and Mexico, \$27.97—one year only. U.S. funds drawn on a U.S. bank. Nationally distributed by International Circulation Distributors. Foreign subscriptions (surface mail), \$44.97—one year only. U.S. funds drawn on a U.S. bank. Foreign subscriptions (air mail), please inquire. **Postmaster:** Send address changes to *inCider*, Subscription Services, P.O. Box 911, Farmingdale, NY 11737. (Send Canadian changes of address to: *inCider*, P.O. Box 1051, Fort Erie, Ontario L2A 5N8.)

1-800-548-8244 (ORDERS ONLY)

312-355-9749

(INQUIRIES, ILLINOIS ORDERS,

CUSTOMER SERVICE & ORDER STATUS)

Mail Order Hours: MON.-FRI. 9:00-5:00, Retail Hours Please Call.

TERMS: Check, Money Order, VISA, MasterCard or American Express. Please add 2% for credit card purchase. Personal

checks allow 2 weeks to clear. Illinois residents add 6.25% sales tax. Prices subject to change. **SHIPPING/HANDLING:** Within Continental U.S. add \$2.50 per shipping carton. For APO, FPO, Alaska, Hawaii & Foreign add 5% (min. \$5.00). Please call for freight charges on large P.O.'s. Orders totaling \$25 or less add \$3.00 handling charge. **RETURNS:** An RMA Number must be obtained before any merchandise is returned. Defective goods returned to Micro City will be repaired or replaced at the discretion of the manufacturer. We can not guarantee machine compatibility. Non-defective merchandise returned will be charged a 10% restocking fee, with the exception of generic products. All returns must be complete units in original packaging.

**PURCHASE ORDERS WELCOME FROM SCHOOLS AND WELL-RATED COMPANIES
DEALER INQUIRES INVITED**

Micro City →

A Division of Pace Systems, Inc.
24W500 Maple Ave., Naperville, IL 60540

Photo & Illustration credits: Cover design, Donna Wohlfarth; contributing cover photographers, Susan Wilson, George Steinmetz; pages 44, 45, Richard Cowdrey; pages 50, 63, 66, Peter Bono; pages 70, 71, 72, 73, 74, 75, 76, 77, Frank Cordelle; page 95, Rose Gibson.

ON THE COVER

44 What's On Line?

by Wendy Lea McKibbin

An overview of the many services you can access with your modem, including five profiles of successful users and a list of products and data bases.

ARTICLES

50 You Can Do Better

by Cynthia E. Field

inCider looks at self-help software that can analyze your personality, design a house or garden, keep you fit, or put you on a diet. Lots of product information is included to help you choose.

70 More Baud for the Buck

by Bill O'Brien

An in-depth review of four 2400-baud modems, plus a look at three "no-frills" modems for the modest spender.

75 Make a Modem

by Perry Donham

A hardware project that teaches you how to make an inexpensive modem at home.

94 NutraHelp

by Vincent D. O'Connor

Here's an easy-to-use food-analysis program to help you plan nutritious meals.



DEPARTMENTS

inCider's View 6

It's Not Weird Anymore—I Am
by Deborah de Peyster

Letters 10

News Line 16

Cheap Copies; No More Towers of Babel; Making 1200 Baud Obsolete?; Apple's Evangelist; Calendar

Apple Clinic 21

Sams Computerfacts; The Enhancements and Peripherals; Stuck with European Apple; Descrambling Video; Whatever It Takes; AppleWorks Printouts
by Jim Sather

Reviews 29

Managing Your Money; Pro-Modem 300c; Let's Talk; Viewtron; GENie; BetterWorking Word Processor with Spell-checker; Echo Plus

Status Report 103

Help Wanted
by Paul Statt

Game Room 105

Ballblazer; The Eidolon; Koronis Rift
by Brian J. Murphy

New Products 108

Hints/Techniques 112

ProDOS Cataloger

Coming Attractions 119

Reader Services 119

Editors' Choice 120

Homework Helpers: Tools for Learning

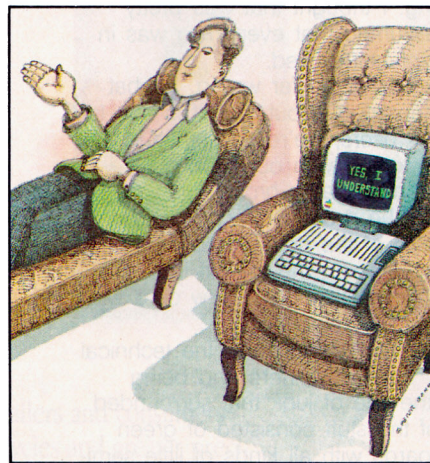

TUTORIALS 50

AppleWorks in Action 79

Cutting and Pasting with AppleWorks
by Ruth K. Witkin

Applesoft Adviser 85

Enhancing Your Applesoft Bar Builder
by Dan Bishop

Pascal Primer 90

Pascal Sets
by Tom Swan

INCIDER'S VIEW

It's Not Weird Anymore—I Am



“We’re constantly in the process of tinkering with our machines. There’s something about the Apple II that invites you to play with it.”

by Deborah de Peyster

This has all come upon me quite by surprise. Looking back, it’s hard to pinpoint exactly when it began, but suddenly I realized I was actually interacting with my computer in a way I never expected.

I noticed it first, I think, while I was sitting at my Apple IIe in the office and typing away with AppleWorks. I was listening to the disk drive whir when I noticed I’d been working with the top off my computer. And I realized I’d been using it that way for some time. Now to many of you, using a computer with its insides exposed doesn’t sound weird. But when I first came to this job last November, I remember noticing that everyone was using a computer with its insides showing. I thought that was pretty weird and assumed that everything was in the process of being fixed.

Actually, I wasn’t too far wrong. If what I’ve recently learned about myself is true for other Apple II users, we’re constantly in the process of tinkering with our machines. Things aren’t necessarily *broken*, they’re just always in the process of *becoming*. I’m always thinking of the next enhancement I want to add. Keeping the top off is a way of reassuring myself that that new card will be here sooner or later.

I also remember visiting with the technical editor in my early days here and being amazed at the pile of junk that surrounded him. Most of the stuff consisted of green computer boards with all kinds of little semiconductor chips, colored humped-looking things, and round silver blobs on them. It was an undecipherable mass of clutter as far as I was concerned. But then, not too long ago, in that very room I found myself eyeing those little green boards with the same lust I reserve for a hot-fudge sundae with nuts and marshmallow sauce.

I also remember the first time my printer failed and produced all kinds of gobbledy-

gook. I threw up my hands, babbled some unprintable words, and stormed into the technical editor’s office to say, “Fix it! I can’t stand it anymore!”

Once again, I muttered to myself while pacing his office and waiting for him to deal with my problem, my computer had come between me and what I want to do.

But something funny happened to me. The last time my printer burped up the same kind of gobbledygook, it didn’t faze me. In fact, I took the cover off the printer, reached for my own small screwdriver (can you believe this?), and readjusted the DIP switches. And I didn’t even think, until now, about what I had done. What’s happening to me?

Here’s the real clincher. The other night I was talking with my husband, a lawyer who has yet to allow a computer into his life, and I heard myself telling him about peeks, pokes, and pointers. I didn’t notice what I was doing until I heard his otherworldly reply, “Oh, you mean pig in a poke?”

And I thought his response was weird! I remember the first time I heard about peeks, pokes, and pointers. My eyes glazed, I mumbled a few “uh, huhs,” and changed the subject as soon as I could.

Programming, I thought—how could anyone want to spend time doing that when so many good applications are available?

But between you and me—and this is how I know I’m really getting weird—there’s something about the Apple II that invites you to play with it: to interact on more than a nonpersonal level, to really find out what makes it tick. So here it comes—I’m going to type in a listing. I don’t have any big reason for doing it, other than that I really want to see how it works and see if I can do it. And then once it’s all in, maybe I’ll change a few lines and see what happens. ■

Quality Products You Can Depend On

MACH III JOYSTICK™

MACH II JOYSTICK™

PADDLESTICKS™

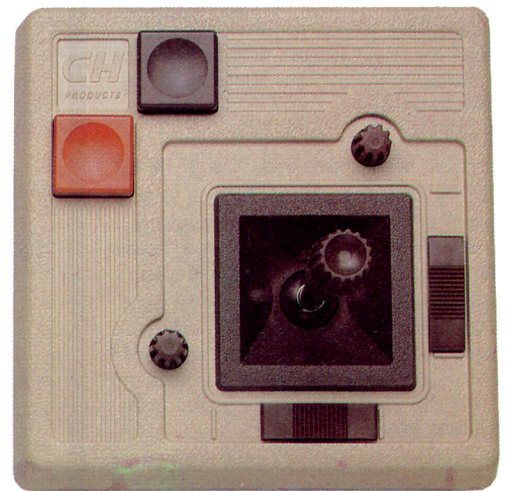

Our controllers are the number 1 choice of retailers and consumers today. They provide more features, longer life cycles and greater precision than all others. With compatibility across a wider range of programs — from games to business to graphics to cad applications.

CH Products, the leading manufacturer of precision analog joysticks for industry and home delivers the highest quality computer peripherals available today. With over 24 years of joystick manufacturing and experience you can expect the best from CH Products.

CH Products 1225 Stone Drive, San Marcos, California 92069 (619) 744-8546



MACH III \$54.95 MACH II \$44.95 available for Apple II, II+, IIE, IIC and IBM PC.
PADDLESTICKS \$44.95 AVAILABLE for Apple II, II+, IIE, and IIC.

Apple II, II+, IIE, IIC and IBM PC are registered trademarks of Apple Computer Inc., and International Business Machines respectively.

LETTERS

Where's the Program?

I live in a small farming community that would make Peterborough look like New York. It often gets down to 45 degrees below zero, and our computers take a beating.

I'm the only person up here even resembling a hacker, and I wouldn't call myself that by any means. Your magazine and others are constant companions, since no one here talks about computers. *inCider* means a trip to town every month—some 120 miles away. (A subscription would rob my wife and me of the reason for going to town.)

So it's with great disappointment that I have to agree with the person who wrote in the last ATACC (Alberta Teachers Association Computer Council) newsletter that "the quality of *inCider* has slipped somewhat in the last little while." He pointed out that at one time there were many programs. Now there are virtually none.

We used to get interesting ways of dumping vectors, bizarre little two-liners (which are very useful teaching tools), and great games. *inCider* had its pulse on what we wanted. Now there seems to be some confusion.

I like *inCider* very much, but I think something can be done to enhance it and make it more useful to those of us who really enjoy reading it.

Jerome Cherry
Box 126
Worsley, Alberta
Canada T0H 3W0

BASICally Professional

I'm writing in response to advertisements for a Pascal language that frequently appear in your magazine and state in no uncertain terms that "professional software isn't written in BASIC." On the off chance that some of your readers might believe that statement, I'd like to contradict it.

I'm a research biochemist, and use computers in the laboratory extensively. Among the software I've recently purchased and find quite useful are Hi-Res Electronic Design, Scientific Plotter, GrafPak II, and Quick-Shape, all of which are written in BASIC. I also write my own programs in

BASIC for statistical analysis of data, data capture, and plotting. Although I run programs written in everything from machine language to FORTRAN, BASIC programs are the most useful to me because they're the most interactive and the easiest to adapt to my lab's specific needs.

When you say something like "professional programs are not written in BASIC," you're creating a personal definition of "professional." I suspect most *inCider* readers realize that, but I wanted to provide some relevant facts on the subject.

Phillip W. Albro
808 Griffis Street
Cary, NC 27511

//c Portability

As small-business owners, my wife and I several years ago chose Apple //e's for our business needs. Needless to say, we've been very pleased with the hardware and software available.

Upon reading your article concerning Judy Collins (March 1986, p. 18), we identified with her in several ways. First, we're products of the 1960's and enjoy her music. Second, it's inconvenient not being able to use an Apple //c on the road to do research and communicate with our offices.

We purchased a //c with Apple's promise that it would be portable. After the \$600 "lemon" LCD screen came out, I wrote Apple a letter concerning the portability of the //c, and even quoted *inCider's* review of the LCD (June 1985, p. 95). I have yet to get any help from Apple in solving the portability situation to make the //c worth the price. *inCider* could help many of us by putting together an article on making the //c really portable—LCD screens, power packs, cases, and so on.

Thanks for your time and concern.

James R. Muir
1424 DeAnza Street
Barstow, CA 92311

Church Users

I'm a new subscriber to your magazine, and so far, I'm really enjoying it. We have two Apple computers we're using in our church.

I was wondering if you could help me get in touch with some kind of "church user group."

Howard Gwartney, Pastor
Central Free Will Baptist Church
3200 Blue Ridge Extension
Grandview, MO 64030

In doing the research for our September 1985 cover feature "Not for Hackers Only" (p. 16), our news editor didn't come across any church-related user groups. If any readers know of church-affiliated computer clubs, please contact Reverend Gwartney at the above address.—eds.

They're Enhanced

I'm confused. I've been a devoted Appler for many years, and I'm very happy with my //e at home. I teach writing courses at Towson State and was very pleased when the College of Education decided to go with Apple. We've recently added several new //e's, because everything we already had was Apple and therefore interchangeable. But the new //e's aren't really the same—they're enhanced.

The rude awakening came when the old Apple Writer wouldn't function on the new units. When I inquired at a local dealer's, he responded, "No problem. Just send the Apple Writer disk to Apple with \$50 and they'll upgrade it." Huh? Fifty dollars? In the end I merely copied the new ProDOS Apple Writer, and we now use it with both units.

It was his follow-up comment that really bothered me. He said, "These new //e's are 'enhanced.' They think they're //c's." If I wanted //c's, I would have ordered //c's, but I didn't. Just what is this enhancement all about?

Some input from others, as well as Apple, would be greatly appreciated—especially now, when I'm feeling a little down. The "new" Apple //e may be enhanced, but I'm not.

William L. Gehring, Ph.D.
Towson State University
Towson, MD 21204



Bring your Apple II Out of the Dark Ages

Display images of clearly superior quality

View colorful images with sharp, clear definition. The Princeton HX-9 gives you super sharp 80-column text and graphics in up to 16 brilliant colors* on a fine .28mm dot pitch tube. (By comparison, the Apple Color 100 has a dot pitch of .38mm). Princeton's dark-glass, nonglare screen further enhances viewing capability.

Ergonomically designed

The small footprint and sleek, professional styling make it the monitor of choice for your workplace where space is at a premium.

Adjust the HX-9 to a comfortable viewing angle with the built-in tilt and swivel base. A built-in green/amber switch allows you to switch from color to green or amber modes. Use the IBM/Apple color switch to select IBM or Apple color modes when creating graphic displays.



Apple color modes when creating graphic displays.

Princeton quality is built in

The Princeton HX-9 is manufactured under tough quality control standards. And backed by a full one-year warranty.

Proven market acclaim

"When I started this comparative review, I convinced myself there was no way to select a clear-cut "best" RGB monitor... I was wrong... Princeton Graphic System's HX-9 is an outstanding choice. It beats the rest by a wide margin."
—*InCider*, Oct. '85

"Its cabinet is stylish, and it takes up very little room... Overall I found the HX-9 to be an excellent product and give it a high recommendation."
—*Computer & Software News*, Nov. 18, 1985

Visit your local computer store today

Inquire about the HX-9 High Resolution Color Monitor and the rest of our line of high performance color monitors. To find the name of the dealer nearest you, call toll-free, 800-221-1490 ext. 5 (609-683-1660 NJ only).
Telex: 821402 PGSPRIN

Princeton Graphic Systems, 601 Ewing Street,
Building A, Princeton, NJ 08540

* Apple IIc or IIe, when used with an RGB interface card such as the Video 7 Color Enhancer IIc or IIe, and others. Check with the board manufacturer for complete compatibility and installation information.

PRINCETON™

GRAPHIC SYSTEMS
AN INTELLIGENT SYSTEMS COMPANY

**WITH THIS
ONE PROGRAM
YOU CAN EASILY
DESIGN,
ORGANIZE,
FILE,
SEARCH,
SORT,
CALCULATE,
MERGE,
AND PRINT
USING FLOPPY
OR HARD DISK.**



**ALL FOR
ONLY \$99.95.**

**ProFILER 2.1 - A SINGLE-DISK
DATA MANAGER/REPORT GENERATOR**

With ProFILER 2.1, you get power, flexibility, and ease of use—all on one floppy disk. And you can easily transfer all your data to hard disk without additional data entry. To get a whole lot more out of your Apple—for a whole lot less—order today.

- Up to 1500 records per floppy—65,000 on hard disk
- Multiple files per disk, multiple index files, full screen editor
- ProDOS generates reports 8 times faster than DOS 3.3
- AppleWorks compatible
- Optional data conversion program for PFS users

See your dealer or order today!

1-800-628-2828 Ext. 530

Plus \$3 shipping and 6% CA tax

Dealer Inquiries Invited



17610 Beach Blvd. Suite 29
P.O. Box 1788
Huntington Beach, CA 92647
714-963-2221 • 714-841-7400

ProFILER 2.1 developed by Custom Computer Products. PFS is a registered trademark of Software Publishing Corp. Apple, ProDOS, and AppleWorks are registered trademarks of Apple Computer, Inc. Price shown reflects suggested retail.

LETTERS

When I'm typing rapidly with Apple Writer II on the unenhanced //e, it can't accept characters fast enough, and frequently skips. The machine can't read the keyboard letters fast enough to get them into the buffer. One solution is to use a faster chip, like the one in the enhanced version.

Apple Writer II doesn't work on the enhanced //e, though. When you load the program, goofy symbols appear in the text-editor display. When you type something in, it doesn't go to the end of the line on the monitor, but stops about an inch short.

A solution to this would be to get an updated version of Apple Writer compatible with the enhanced //e. We have more than 45 floppy disks of text files that must be accessible, though. To date, no one has been able to assure us that we can run our current text files on the enhanced //e with either this software or a newer version.

In the meantime, we're stuck with a machine and a system that has a very cumbersome feature. Help from any source would be greatly appreciated!

Peter S. Vail
9 Elysian Drive
Andover, MA 01810

Those "goofy symbols" you see on your enhanced //e or //c are called "mousetext" characters. They replace inverse capitals—like the text-editor display—in the newer Apple II's. They make it easier for II's to use a Mac-style display, but harder for you to use Apple Writer II and other early 80-column software.

You have several choices. First, you could ignore the mousetext. When Dawn Matthews, inCider's managing editor, uses Apple Writer II on her //c, she "escapes" to a screen with no inverse characters in the text-editor bar, and goes on as before (although capital letters under the cursor will also be unrecognizable on screen). Or get the new ProDOS Apple Writer II and convert all your files—it's not difficult. (This is what Apple wants you to do.)

You could buy a Franklin Ace 2000, which lets you enable and disable mousetext with a switch. Or, best of all, get a faster word processor, such as AppleWorks. —eds.

Mislabeled Megabytes

As a follow-up to your fine article on hard-disk drives ("Hard-Driving Disks," September 1985, p. 24), please issue this word of caution. The Apple ProFile comes in 5- and 10-megabyte versions, but the storage capacity is not clearly marked on the unit purchased.

I purchased a 10-megabyte ProFile in August. When I formatted the disk and checked the block allocation, I discovered I only had 5 megabytes of storage. My supplier, Programs Plus, of Stratford, Connecticut, admitted that its customer-service people couldn't tell the storage capacity of the disk, and had shipped me the wrong one. I've been waiting nearly two months for a replacement to arrive from Apple, via Programs Plus.

John F. Fitzgerald
Central Office Systems
11 Davis Avenue
Valhalla, NY 10595

Corrected Hint

Joseph Movich of LaVerne, California, correctly informed me that my "hint" on page 40 of the November inCider is incorrect in one particular. The problem with GET and Escape isn't that the escape key doesn't set the high bit, but that the 80-column-monitor routines preempt escape (unless you have a //c or an enhanced //e). Thus, in Listing 1, line 30040 is superfluous.

Dan G. McCartney
3010 Turner Avenue
Roslyn, PA 19001

inCider welcomes readers' comments regarding articles, letters, or other topics of interest. We reserve the right to edit letters for clarity, style, and space. Please address your correspondence to Letters, inCider, 80 Pine Street, Peterborough, NH 03458.

CORRECTION

The address of COMPUTER:applications, makers of II in a Mac emulation software, was printed incorrectly in our February 1986 issue (p. 12). The actual address is 12813 Lindley Drive, Raleigh, NC 27614.

APPLE[®] MODEM. WITH EVERYTHING.

Plug-in Modem Card
with Software
for the Apple II, II+, IIE

\$69

Order Now!
Includes Over \$275
in Database Offers!

Buy two for only \$99!

The NETWORKER™ Modem

An incredible price on a great little modem. 300 baud full duplex, manual originate/answer with carrier detect LED. Just plug into any slot in your computer. Complete with DOS/ProDOS compatible Communications Software, Phone Cord, Instructions, and over \$275 in discounts and connect time for CompuServe, the Source, Dow Jones, and more. Made in USA. 1 year warranty. **Only \$69. Special offer! 2 for only \$99!**

NETMASTER™ Advanced Software

Add NETMASTER Advanced Communication Software for File Transfer with Xmodem automatic error-checking, a Full-screen Text Editor, Dialing Directory, Printer Control, Disk Storage and Retrieval and more. Full documentation in an attractive 3-ring binder. Not copy-protected. Requires only 48K RAM memory. Originally \$79. **Now only \$29!**

15-day no-questions-asked money-back guarantee

Send this coupon with your check, money order or credit card information to:

TELSTAR, 145 Lincoln St., Boston, MA 02111

Please send me _____ NETWORKER Modems (1 @ \$69 or 2 @ \$99) \$ _____
 _____ NETMASTER Advanced Software @ \$29 \$ _____
 Postage & Handling \$ 2.00
 Total \$ _____

MC VISA AMEX No. _____ Exp. Date _____
 I enclose a check or money order to: TELSTAR Communications

Name _____ Phone _____

Address _____

City _____ State _____ Zip _____

Or Call Toll Free MC, VISA, AMEX Accepted
1-800-344-3311 In MA 1-617-423-1237

edited by *inCider* staff

Cheap Copies

You may have heard the term "site license," usually in a sentence that begins, "I wish software manufacturers would offer a" In the software industry, *site license* basically means a volume discount. It gives you the okay to make an agreed-upon number of copies of a software application for a price that's more than the cost of one application, but much less than the cost of each application if purchased at retail.

Site licenses are particularly of interest to businesses and schools, where one application may be used by as many as several hundred people. To get the required numbers, those applications are often copied illegally. When disks are copy-protected, far fewer are purchased than are actually needed. In both cases, everyone loses. But not very many software companies offer site-license agreements, and even fewer offer such agreements for education.

But a new product called LogoWriter, from Logo Computer Systems Inc. (LCSI), promises to make teachers honest again. For \$395 a school can purchase the programmable word processor and make as many copies as needed in the classroom. For an extra \$150, each student can take a copy home. And \$99 a year brings updates and new products at no extra cost.

Each site license includes software for 64K Apple II's, Commodore 64's, and IBM PCjr's for one price. If the school changes brands later, or if Apple announces a customized 128K Apple II for schools, the school will get the program it needs at no extra charge.

The company "wants to create a partnership, an atmosphere of trust, between the educational-software industry and teachers," says William Nisen, marketing vice president of LCSI. To that end, LCSI also supplies LogoWriter package mate-

rials for teachers, a hotline for technical and educational support, a free bi-monthly newsletter, and an open forum for teachers to publish original LogoWriter programs for payment.

Seymour Papert, chairman of LCSI and creator of the Logo language, has long called for "equity of access to powerful machines." With its straightforward plan to give schools the software they need, LCSI is trying to give children that access, Papert says.

No More Towers of Babel

Apple and 23 other high-tech companies, including IBM, Hewlett-Packard, DEC, and Wang, have banded together to form an industry organization called the Corporation for Open Systems (COS), which will push for telecommunications stan-

dards. Should the group agree on a standard, individual computer users will find they can connect to a greater variety of services than is now possible.

They'll also be able to transmit data more easily and with fewer errors, according to Apple's director of data-communications development, Karl Kimball.

Kimball explains that vested-interest groups and regulatory agencies have produced variations on everything from document-interchange procedures to algorithms for encoding digital information.

"COS is an attempt by industry members to identify the most important standards, get behind them as a group, and bring them to ground zero," Kimball says. "Or in other words, to get standards everyone can agree on."

Making 1200 Baud Obsolete?

When Pacific Bell releases a patent-pending technology next year, it may have a chilling effect on the sale of modems as we know them today.

The as-yet-unnamed communications product (code-named Project Victoria) will operate at 9600 baud, or eight times faster than a 1200-baud Hayes Smartmodem. It will also convert a single phone line to five data channels and two voice lines. That means a Pacific Bell box hooked up to a single phone line at home will give the personal-computer owner a dedicated data line to the outside world and four channels of communication for services such as fire-

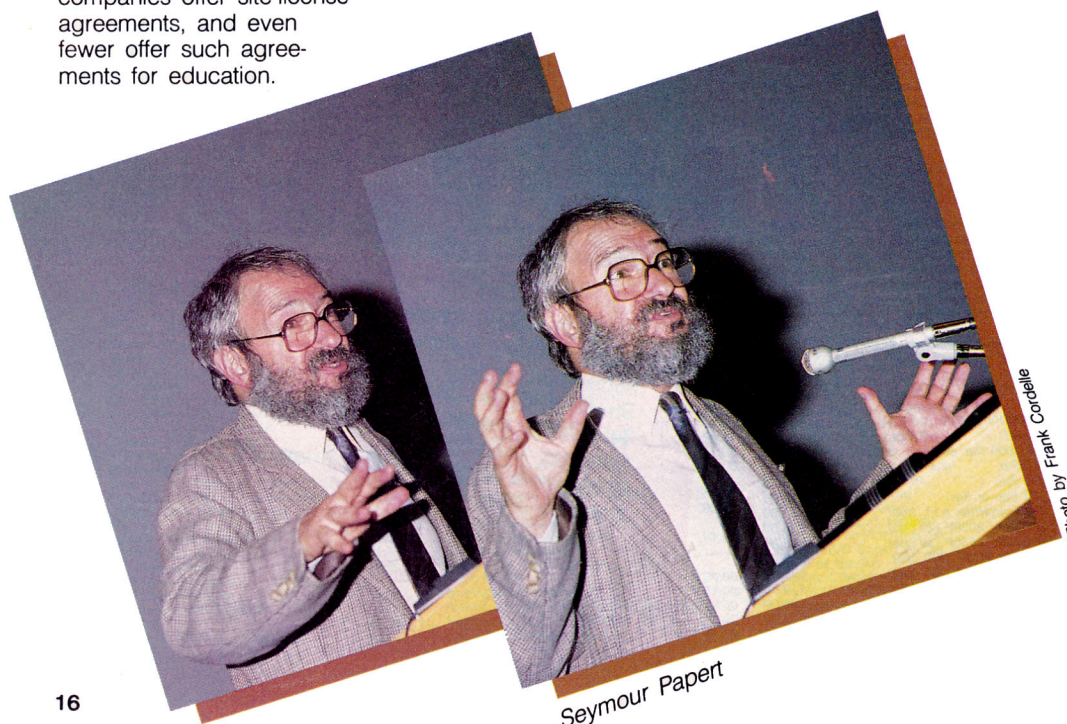

Seymour Papert

Photo by Frank Corbelle

and burglar-alarm systems, energy management, or paid-television selections. It will still leave two phone lines free for voice communication.

The price? Pacific Bell estimates the cost will be roughly equal to that of a quality 1200-baud modem. Gary Betty, vice president of sales for Hayes Micro-computer Products, of Norcross, Georgia, says the company isn't concerned about Project Victoria, though.

"Everyone's always predicting an end to the modem market, whether because of local-area networks, integrated systems, digital networks (ISDN), or modem servers," Betty says. "With only one out of four personal-computer owners currently using a modem, there's still a tremendous market opportunity for us. In fact, the

Pacific Bell product may even be a stimulus for spurring sales for our modems, since the community of people involved in telecommunications will be increased."

Apple's Evangelist

They dined as a small, intimate group by candlelight at San Francisco's Maxwell Plum restaurant, danced to the Temptations at a gala party at the San Francisco Galleria, and met with key Apple executives, including Apple president John Sculley, to learn about programs and support from Apple.

They were a group of Apple computer users who were invited to attend the AppleWorld Expo and be part of the first Apple program arranged by its new Apple User Evangelist, Ellen Petry Leanse. The idea for a user-group evangelist actually came from users themselves. During a meet-



Courtesy of Apple Computer, Inc.

Ellen Petry Leanse

ing with Apple last summer, users made their need clear: someone within Apple to represent the user.

Apple apparently thought it was a good idea, too, and appointed Ms. Leanse. "Her primary role is to be the Apple contact who funnels all the information from user groups and ensures good two-way communication," an Apple spokesperson says. Besides throwing a good party, Ms. Leanse

is setting up an on-line user service based on Apple-Link, which should be in operation soon. She has also appointed a User Group Advisory Council to keep her apprised of user needs.

And she wants to make sure she hears from all the user groups out there. If your group hasn't made contact yet, have your representative call (408) 973-2700 and ask for Ellen Petry Leanse, User Group Evangelist. (Yes, that's really what's printed on her business card.)

We're always looking for news of the Apple world. If you're making news, send your press releases and photographs to News Line, inCider, 1060 Marsh Road, Suite C-200, Menlo Park, CA 94025.

CALENDAR

April 28-May 1 COMDEX/SPRING

Atlanta, GA
contact:
Linda M. Yogel
Linda Hanson
Interface Group
300 First Avenue
Needham, MA 02194
(617) 449-6600

May 3 BAY AREA COMPUTER SWAP

San Francisco, CA
contact:
Janet Maineri
MicroShows
1209 Donnelly Avenue
Suite 203
Burlingame, CA 94010
(415) 340-9114

May 8-10

Houston, TX

May 15-17

Minneapolis, MN

COMPUTER AND BUSINESS EQUIPMENT SHOWCASE

contact:
Interface Group
300 First Avenue
Needham, MA 02194
(617) 449-6600

May 11-15 COMPUTER GRAPHICS '86

Anaheim, CA
contact:
Linda Baker
Sheila Donoghue
National Computer
Graphics Association
2722 Merrilee Drive
Suite 220
Fairfax, VA 22031
(703) 698-9600

William F. Gollan
President, BCP

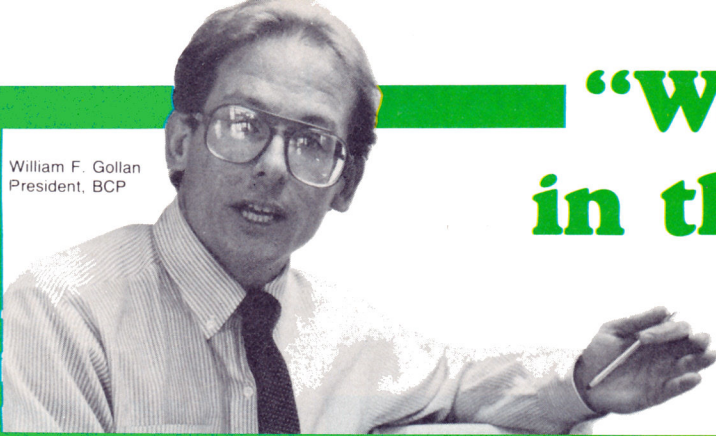

"We will match in this issue, our and shipping,

We'll support, service and warranty everything we sell and stand behind it 100%.

MODEMS	PRINTERS DOT MATRIX	BUSINESS SOFTWARE	UTILITIES & LANGUAGES
<p>D.C. Hayes</p> <p>Micro Modem IIe w/sc 144.95 Smart 1200 379.95 Smart Modem 2400 589.95</p> <p>Prometheus</p> <p>Pro 1200 299.95 Pro 1200 A w/sc 279.95</p> <p>PERIPHERALS</p> <p>Amdek</p> <p>300 G 12" Green 124.95 300 A 12" Amber 129.95 Color 300 Composite 229.95 Color 500 RGB 264.95 Color 600 RGB 384.95</p> <p>Apple</p> <p>II E's & II C's & Macs CALL</p> <p>Applied Engineering</p> <p>All Products CALL</p> <p>AST</p> <p>Multi I/O 159.95</p> <p>Checkmate Tech</p> <p>Multiram II E 64K + 80 139.95 Multiram II E 256K + 80 179.95 Multiram II E 512K + 80 229.95 Multiram II E 768K + 80 279.95 Multiram II E 64K RGB + 80 189.95 Multiram II E 512K RGB + 80 279.95 Multiram II E 1024K RGB + 80 389.95 Multiram II 1792K RGB + 80 559.95 Multiram II EX w/VIP 249.95 Multiram II CX w/256K 249.95 Multiram II CX w/512K 299.95 Multiram II CX16 w/256 329.95 Multiram II CX16 w/512 379.95 Multiram CX 16 Kit w/VIP 219.95 Multiview 80/160 224.95</p> <p>Curtis</p> <p>Diamond 35.95 Emerald 39.95 Ruby 59.95</p> <p>Disks</p> <p>Verbatim Bonus SS/DD 12.95 Verbatim Bonus DS/DD 16.95 Verbatim Datalifes SS/DD 19.95 Verbatim Datalifes DS/DD 25.95 Maxell MD1 SS/DD 16.95 Maxell MD2 DS/DD 24.95</p> <p>Kensington</p> <p>Printer Stand 19.95 System Saver 64.95</p> <p>Koala Technologies</p> <p>Koala Pad + 77.95</p> <p>Joysticks</p> <p>Kraft 39.95 Kraft Quickstick 54.95 Hayes Mach III's 39.95</p> <p>Quadram</p> <p>Microfazer P/P 128K 169.95 Microfazer S/S 64K 179.95 Multicore W/256K 299.95 ProDOS Clock Calendar 69.95</p> <p>Titan</p> <p>Accelerator 229.95 64K Ram 159.95 128K Ram 184.95</p> <p>GRAPHIC INTERFACES</p> <p>Orange Micro</p> <p>Grappler + 84.95 Grappler + w/64k 154.95 Grappler + RS-232C 84.95 Grappler C 84.95 Hot Link IIc 54.95</p> <p>Textprint</p> <p>Print It 134.95</p> <p>Thirdware</p> <p>Fingerprint + 104.95 Fingerprint + IIC 104.95</p> <p>PRINTERS DOT MATRIX</p> <p>Apple*</p> <p>Imagewriter II 10" & 15" CALL</p> <p>Citizen</p> <p>MSP 120D 209.95 MSP 10 160 279.95 MSP 15 160 379.95</p>	<p>MSP 20 200 349.95 MSP 25 200 519.95</p> <p>Epson America</p> <p>AP 80 Image 279.95 LX 80 249.95 LX 80 F/T 279.95 FX 85 379.95 FX 286 539.95 LQ 800 579.95 LQ 1000 699.95</p> <p>Okidata</p> <p>ML 192 354.95 ML 192 Image. 379.95 ML 193 489.95 ML 193 Image 559.95</p> <p>BUSINESS SOFTWARE</p> <p>ALS</p> <p>Handler Pkg. 104.95 Spellworks 37.95</p> <p>Apple</p> <p>Appleworks 194.95</p> <p>Arrays</p> <p>Home Accountant 46.95</p> <p>BPI Software</p> <p>AR, GL, PR, AP, IC (ea) 209.95 Prodos Versions (ea) 219.95</p> <p>Broderbund</p> <p>Bank Street Writer 45.95 Bank Street Speller 45.95 Bank Street Filer 45.95 Bank Street Mailer 45.95</p> <p>Compuserve</p> <p>Subscription Kit 20.95</p> <p>Dow Jones</p> <p>Investors Workshop + IIC 94.95 Market Microscope 209.95 News Retrieval 21.95</p> <p>Howardsoft</p> <p>RE Analyzer III 199.95</p> <p>Human Edge</p> <p>Mind Prober 34.95</p> <p>Int'l Solutions</p> <p>Mouse Budget 59.95 Mouse Desk 29.95 Mouse Word 84.95 Mouse Calc 97.95</p> <p>Intuit</p> <p>Quicken 54.95</p> <p>Kensington</p> <p>Format II 94.95</p> <p>Living Videotext</p> <p>Think Tank 84.95</p> <p>Manzanita</p> <p>GL,AR,AP,IC (ea) 264.95 PR 309.95 Business Master 74.95</p> <p>Megahaus</p> <p>MegaWorks 79.95 Report Works 79.95</p> <p>Microsoft</p> <p>Multiplan 69.95</p> <p>Monogram</p> <p>Dollars & Cents 63.95 Dollars & Cents IIC 73.95 Forecast 43.95</p> <p>Peachtree</p> <p>Back to Basics 114.95 Back to Basics A/R, A/P, G/L (ea) 64.95</p> <p>PBI</p> <p>JEEVES 43.95 Graphworks 64.95</p> <p>Quark</p> <p>Catalyst 3.0 69.95 Word Juggler 3.0 134.95</p> <p>Roger Wagner</p> <p>Mouse Write 84.95</p> <p>Sensible Software</p> <p>Bookends 84.95 Sensible Speller IV 74.95 Graphics Dept. 74.95 Sensible Grammar 69.95</p> <p>Sierra On Line</p> <p>Homeward + 47.95 Homeward Speller 34.95 Home Word Filer 47.95 Screenwriter Pro 84.95</p>	<p>Software Publishing</p> <p>PFS:1st Success 139.95 PFS:WR, GR RP, PL (ea) 74.95</p> <p>Sorcim/IUS</p> <p>Super IIIA 109.95</p> <p>SSI</p> <p>Word Perect 84.95 Spellchecker 21.95</p> <p>United Software</p> <p>AScii Express 84.95</p> <p>UTILITIES & LANGUAGES</p> <p>Activision</p> <p>Kitchen's Game Maker 34.95</p> <p>Baudville</p> <p>Actors & Actions 23.95 Business 35.95 Blazing Saddles 35.95 Heroes & Villans 23.95 Pixit 35.95 Prince Color (Epson) 49.95 Prince Color (Prowriter) 49.95 Shape Lib. 1,2,3 (ea) 13.95 Take 1 39.95</p> <p>Beagle Brothers</p> <p>Alpha Plot 27.95 Apple Mechanic 20.95 Bag 20.95 Basic 24.95 Big U 24.95 Graphics 37.95 D-Code 27.95 Diskquik 20.95 DOS Boss 18.95 Double-Take 24.95 Extra K 27.95 Fat Cat 24.95 Flex Text 20.95 Font Mechanic 20.95 Frame-Up 20.95 GPLE 32.95 I.O. Silver 20.95 Mini Pix #1 20.95 Pro-Byter 24.95 Pronto DOS 20.95 Shape Mechanic 26.95 Silicon Salad 18.95 Tip Disk # 1 13.95 Triple Dump 27.95 Typefaces 13.95 Utility City 20.95</p> <p>Borland International</p> <p>Turbo Pascal 3.0 41.95 Turbo Tool 34.95 Turbo Tutorial 25.95</p> <p>Broderbund</p> <p>Dazzle Draw 41.95 Print Shop 34.95 Print Shop Companion 29.95 Print Shop GL 1,2,3 (ea) 19.95 Print Shop Refill Paper 13.95</p> <p>Central Point</p> <p>Copy II + 24.95</p> <p>Data Transforms</p> <p>Fontrix 59.95 Font Set(s) (ea) 19.95</p> <p>Funk</p> <p>Sideways 37.95</p> <p>Microsoft</p> <p>Applesoft Compiler 109.95 Basic Compiler 249.95 COBOL-80 41.95 Fortran-80 129.95 M-Sort 80 129.95</p> <p>Microstuff</p> <p>Crosstalk 109.95</p> <p>Mindscape</p> <p>Mister Pixel's 23.95 Cartoon Kit 23.95 Paint Set 23.95 Color Me (Main) 9.95 Rainbow Brite 9.95 Shirt Tales 9.95 Hugga Bunch 9.95 Tink Tonk 9.95</p> <p>Penguin Software</p> <p>Cat Graphics 24.95 Complete Graphics System 54.95</p>	<p>Graphics Magician 42.95 Magic Paintbrush 24.95</p> <p>Pinpoint</p> <p>Pinpoint 44.95 Pinpoint Spellchecker 79.95 Pinpoint Toolkit 34.95 Pinpoint Ram Exp. 13.95</p> <p>Roger Wagner</p> <p>Merlin Assembler 40.95 Merlin Pro 64.95 Merlin Combo 69.95</p> <p>Springboard</p> <p>Newsroom 37.95 Newsroom Clip Art 22.95 Newsroom Graphic Exp V1 29.95</p> <p>Terrapin</p> <p>LOGO 64.95</p> <p>Unison</p> <p>Print Master 29.95</p> <p>EDUCATIONAL & PERSONAL</p> <p>Bantam</p> <p>Fantastic Animals 29.95 Road Rally USA 29.95 Scarsdale Diet 29.95</p> <p>Barrons</p> <p>Computer SAT 59.95</p> <p>CBS</p> <p>Goren's Bridge 56.95 Mastering SAT 66.95</p> <p>Davidson Associates</p> <p>Classmate 34.95 Math Blaster 34.95 Speed Reader II 45.95 Data Disks A,B,C,D (ea) 14.95 Alge Blaster 34.95 Spell It 34.95 Word Attack 34.95 Data Grade(s) (ea) 14.95</p> <p>Designware</p> <p>European Nations 31.95 Grammer Exam. 31.95 Remember 49.95 Spellcopter 29.95 Spellakazam 29.95 States & Traits 31.95 Body Transparent 31.95</p> <p>Electronic Arts</p> <p>Cut & Paste 27.95 Financial Cookbook 37.95 Movie Maker 31.95</p> <p>Fisher Price</p> <p>Alpha Build 21.95 1st Man on Moon 23.95 Jungle Reading 23.95 Logic Levels 21.95 Peter R. Reading 23.95 Peter W. Music 23.95 Sea Speller 18.95</p> <p>Hayden</p> <p>SAT Math 36.95 SAT Verbal 36.95</p> <p>Learning Company</p> <p>Addition Magician 26.95 Bumble Plot 29.95 Gertrudes Puzzle 31.95 Gertrudes Secrets 31.95 Juggle's Rainbow 23.95 Magic Spells 25.95 Moptown Hotel 29.95 Moptown Parade 29.95 Number Stumper 29.95 Reader Rabbit 29.95 Robot Odyssey 34.95 Rocky's Boot 34.95 Word Spinner 25.95</p> <p>Meca</p> <p>Managing Your \$ 109.95</p> <p>Milliken</p> <p>Addition Seq. 26.95 Division Seq. 26.95 Word Processor 47.95</p> <p>Mindscape</p> <p>Perfect Score 49.95 Keyboard Cadet 29.95 Lusher Profile 29.95</p>

ORDERS ONLY 1-800-845-3003

any mail order price prices include all handling there's no hidden charge."

6 YEARS OF CONTINUOUS GOOD SERVICE

EDUCATIONAL & PERSONAL

Bank St. Music	37.95
Bank St. Story B.	29.95
Pinpoint	
Micro Cookbook	34.95
Added Menu's (ea)	13.95
Quality	
Bag of Tricks II	35.95
Beneath Apple DOS	17.95
Beneath Apple Pro DOS	17.95
Random House	
Charlie Brown's ABC's	29.95
Charlie Brown Typing	29.95
Charlie Brown 1,2,3's	29.95
Garfield Dbl. Dares	29.95
Garfield Eat Words	29.95
Potato Head	29.95
Peanuts Math	29.95
Snappy Writer	29.95
Snoopy Rescue	29.95
Scarborough	
Boston Diet	54.95
Build a Book	29.95
Build Refills 1,2 (ea)	16.95
Mastertype	
New Improved	29.95
Figures & Formulas	21.95
Filer	29.95
Writing Wizard	54.95
Run for the \$	29.95
Songwriter	29.95
Personal Net W.	54.95
Simon & Schuster	
Great Paper Air P	27.95
Typing Tutor III	35.95
JK Lasser \$ Mng.	54.95
Softsync	
Kid Pro Quo	30.95
Model Diet	28.95
Personal Acct.	37.95
Spinnaker	
Adv. Creator	23.95
Alphabet Zoo	24.95
BW Wordproc.	39.95
BW File/Report	39.95
BW Spreadsh.	39.95
Counting Parade	23.95
Delta Drawing	29.95
Fraction Fever	21.95
Grandma's House	21.95
Homework Math/Word	29.95
Homework Writing	29.95
In Search of	25.95
Kids on Keys	20.95
Kindercomp	20.95
Math Busters	23.95
Snooper Trooper 1,2 (ea)	25.95
Story Machine	27.95
Sum Ducks	23.95
Trains	23.95
Springboard	
Early Games	25.95
Easy ABC	29.95
Fraction Factory	23.95
Mask Parade	29.95
Music Maestro	25.95
Piece Cake Math	25.95
Puzzle Master	25.95
Rainbow Painter	25.95
Stickers	25.95
Timeworks	
Silvia Porter \$ Planner	74.95
Evelyn Wood Reader	46.95
Xerox/Weekly Reader	
Sticky Bear	29.95
ABC	29.95
Basket Bounce	29.95
Bop	29.95
Math	29.95
Numbers	29.95
Opposites	29.95
Printer	29.95
Reading	29.95
Shapes	29.95
Spellgrabber	29.95
Town Builder	29.95
Typing	29.95
Codes & Cyphers	29.95
Basic	29.95
Math 2	29.95

GAME SOFTWARE

Access	
Beach-Head II	25.95
Beach-Head	25.95
Activision	
Alcazar	29.95
Borrowed Time	29.95
Countdown to Shut.	29.95
Designer's Pencil	29.95
Ghostbuster's	29.95
H.E.R.O.	29.95
Master Lands	29.95
Mindshadow	29.95
Pitfall	29.95
Road Race	29.95
Rock N Bolt	29.95
Space Shuttle	29.95
Tracer Sanction	29.95
Zenii	29.95
Avalon Hill	
Under Fire	41.95
Avant Garde	
Dave Winfield	29.95
Blue Chip	
Barron	29.95
Millionaire	29.95
Squire	34.95
Tycoon	29.95
Broderbund	
Art of War	29.95
Championship Lode R.	25.95
Choplifter	25.95
Captain Goodnight	25.95
Fantavision	35.95
Karateka	25.95
Mask of Sun	29.95
Serpent's Star	29.95
Where in the World...	28.95
CBS	
Murder by Doz.	28.95
Datasoft	
Alternate Reality	34.95
Bruce Lee	28.95
Conan	28.95
Dallas Quest	24.95
Dig Dug	21.95
Goonies	28.95
Mr. Do	28.95
PacMan	21.95
Electronic Art	
Reach For Stars	34.95
7 Cities Gold	29.95
Sky Fox	29.95
Archon	27.95
7 Cities Gold	29.95
Sky Fox	29.95
Europe Ablaze	37.95
Murder Zindernaul	19.95
Music Const. Set	29.95
Pinball Const. Set	27.95
Archon II: Adept	29.95
Carrier's At War	37.95
Wilderness	37.95
1 on 1	29.95
Epyx	
Rogue	20.95
Koronis Rift	CALL
Summer Games	28.95
Pitstop	28.95
Baseball	25.95

GAME SOFTWARE

Summer Games II	29.95
Winter Games	29.95
Football	29.95
Temple Apshair	21.95
Eidolon	29.95
Crush, Crumble	20.95
Fax	20.95
Mission Impossible	24.95
Hayden	
Holy Grail	35.95
Sargon III	35.95
Infocom	
Cutthroats	28.95
Deadline	33.95
Enchanter	28.95
Hitchhiker's G.	28.95
Infidel	31.95
Mind Voyaging	31.95
Seastalker	28.95
Starcross	33.95
Sorcerer	30.95
Spell Breaker	33.95
Suspect	30.95
Wishbringer	28.95
Witness	28.95
Zork 1	28.95
Zork 2,3 (ea)	30.95
Micro Lge. Sports	
Baseball	29.95
Gen. Mng. Disk	29.95
Microprose	
F-15 Strike	25.95
NATO Commander	25.95
Silent Service	25.95
Solo Flight	25.95
Crusade in Europe	28.95
Decision Desert	28.95
Conflict Vietnam	28.95
Kennedy Approach	25.95
Gunship	25.95
Acro Jet	25.95
Mindscape	
Halley Project	32.95
Stephen King Mist	30.95
James Bond View K.	30.95
Forbidden Castle	30.95
Voodoo Island	30.95
Racter	32.95
Tink's Adventure	22.95
Tonk in Buddy Bots	22.95
Tuk Goes Town	22.95
Tinka's Mazes	22.95
Tinka's Sub. Fair	22.95
Crossword Magic	35.95
Deja Vu	39.95
Rambo Part II	29.95
Voodoo Island	29.95
One Step	
Golf's Best St. Andrew's Old	37.95
Golf's Best Pinehurst	37.95
Origin	
Ultima 3 & 4 (ea)	41.95
Moebius	38.95
Autoduel	35.95
Orge	CALL
Penguin	
Pensate	19.95
Quest	25.95
Swords Kadash	25.95
Transylvania	25.95

GAME SOFTWARE

Crimson Crown (New)	25.95
Priority	
Forbidden Quest	29.95
Sierra On Line	
Frogger	25.95
King's Quest	35.95
King's Quest II	35.95
Black Calderon	29.95
Simon & Schuster	
Super Zaxxon	26.95
Frogger 3 Deep	26.95
Spy Hunter	32.95
Trapper	32.95
Sir Tech	
Wizardry 1	34.95
Wizardry 2	25.95
Wizardry 3	28.95
Wizardry 4	29.95
Rescue Raiders	27.95
Spectrum	
Gato	28.95
Spinnaker/Telarium	
Amazon	29.95
Dragon World	29.95
Fahrenheit 451	29.95
Rendezvous w/Rama	29.95
Shadow Keep	29.95
Strategic Simulations	
Baltic 85	25.95
Battalion Comm.	29.95
Battle Normandy	29.95
Carrier Force	39.95
Computer Ambush	37.95
Computer Quarterback	27.95
Computer Baseball	27.95
Geopolitique	28.95
Germany 85	39.95
Imperium Galactum	28.95
Kampfgruppe	39.95
Mission Crush	28.95
N. Atlantic 85	39.95
Objective Kursk	28.95
Operative Mkt. Gardn.	35.95
Phantase	28.95
Rings Ziffin	CALL
Questron	34.95
War with Russia	54.95
Gemstone Warrior	25.95
Mech Brigade	39.95
Broadsides	28.95
Six Gun Shootout	CALL
Battle of Antietam	CALL
Colonial Conquest	CALL
Sublogic	
Flight Simulator II	35.95

■ Payment: MC/VISA, Certified and Bank Checks processed same day. Personal & Co. checks 21 day clearing.
 ■ Purchase Orders: FOB NH, plus handling.
 ■ APO/FPO: FOB NH, plus 3% handling (min. \$5.00) Alaska/Hawaii
 ■ International: FOB NH, plus 15% handling (min. \$15.00)
 ■ Credit Card Security: MC/VISA orders which are to be shipped or billed to an address other than the card holders will be charged a \$5.00 security center verification fee.
 ■ Returns: All returns must have a valid RMA #. Contact customer service for assistance. Defective software will be replaced with precisely the same product. Defective hardware will be replaced or repaired. If a customer has ordered the incorrect product it may be returned, software will be charged \$8.50 S&H ad hardware \$16.50.
 ■ Compatibility: BCP does not guarantee machine compatibility.
 ■ Matches: BCP must list the product with a price. Products with call do not apply.
 ■ Misc.: Prices and availability subject to change.

CUSTOMER SERVICE
(603) 924-9406

BCP BUSINESS COMPUTERS
OF PETERBOROUGH
GOLFERT CT. INC.
P.O. Box 389
Peterborough, NH 03458

MONTHLY SPECIAL

PRINTER RIBBON

6 Pack Special

	Retail	BCP
• Imagewriter	49.95	24.95
• Epson LX80	74.95	34.95
• Epson FX80/85	49.95	24.95
• Epson FX100/185	74.95	34.95
• Okidata 192 Mac	79.95	39.95
• Okidata 92 Mac	29.95	15.95
.....		
• Imagewriter Color Pac (Br, Pur, Bl, Gr, Rd, Yl)	59.95	29.95

+2.50 Shipping

ORDERS ONLY 1-800-845-3003

MultiRam™ RGB

The //e Memory Card That
Outdoes The Rest!

MultiRam™ RGB's standard features
include an exclusive 10 year
battery backed RAM port,
up to 1 Megabyte of RAM
expandable to 4 Megs,
RGB Video,
and *More*

The MultiRam™ RGB Card offers more standard features than any other //e auxiliary RAM card, features simply not available with other RAM cards or available only as expensive options.

The Hardware

1. With **1 Megabyte capacity**, MultiRam™ RGB is available in sizes from 64K to 1 Meg. Plug in your own 256K or 64K dynamic RAM when you need more memory. Then use our sophisticated, unique hi-res RAM test to show the exact location of any bad RAM on the card while testing. Apple Computer says it's the best RAM test available for any memory card.

2. The **SRAM Port** can be connected to an optional SRAM Pack containing 128K to 2 Megs of Static RAM with 10 year battery backup. Shut off the Apple and all programs and data in SRAM will be there when you turn on the Apple tomorrow. Or next week. Or next year. The SRAM option makes MultiRam™ RGB the only //e memory card that remembers what was stored in it when you turn off the Apple. SRAM Pack options will be available later this year. MultiRam™ RGB is the *first and only* Apple RAM card to offer the SRAM port.

3. Expand MultiRam™ RGB up to 4 Megs using the **memory expansion pins** on the card's back. Add a ¾ Meg MultiRam™ //e card for a 1¼ Meg total. Or add a 3 Meg MultiRam™ Plus card for a 4 Meg total, the most memory available in one slot for the Apple. Because either expansion card fits on the RGB's back (the power supply side), they never touch or interfere with cards in slot 1, another exclusive MultiRam™ feature.

4. The **65C816 CPU Port** allows the MultiRam™ EX 65C816 card, a 16-bit option, to directly address all memory on the MultiRam™ cards without bank-switching. Advanced 16-bit software, like VIP Professional, a Lotus 1-2-3 compatible spreadsheet, can use this memory for power spreadsheets. Another MultiRam™ exclusive.

5. The **RGB Video** connector links the card to any Apple compatible RGB monitor for crisp, vivid 80-column and double hi-res displays. RGB video is standard with the card, an option others charge hundreds for. Of course MultiRam™ RGB also provides you with regular 80-column and double hi-res graphics because it's a direct replacement for the Apple extended 80-column card.

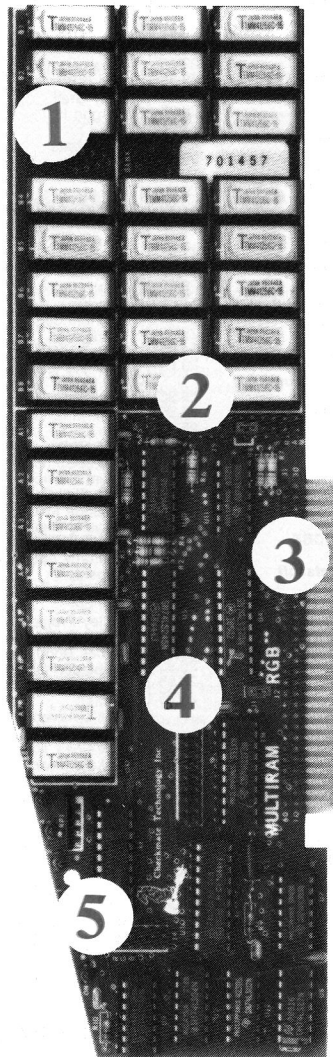

The Software

6. **AppleWorks expansion software** is included with MultiRam™ RGB to expand AppleWorks from 55K to 3,034K, the largest Desktop available. AppleWorks expansion software lets you • automatically segment and save large files to floppy • load all or parts of AppleWorks into RAM (even printer routines) for supercharged speed • easily use a RAM disk along with an expanded Desktop to store Pinpoint and Jeeves accessories for immediate response • create databases of more than 5,300 records vs the ordinary 1,350 records • create word processor files over 5,300 lines (more than 100 pages) • and show date and time on screen with any ProDOS clock and enter them into databases with one keystroke. And we're adding new features all the time.

7. **RAM Disk software** for ProDOS and DOS 3.3 is included with the card. Programs are also included to partition and customize the RAM disks as well as to quickly copy files to and from the immense, lightning fast RAM disk (20 or more times faster than floppies) that can be created from MultiRam™'s memory. Pascal and CP/M RAM disk software is available at nominal cost.

The Service

8. We don't forget you after you buy. **Customer Support** is as important a MultiRam™ feature as any other. Get **free** software upgrades from your dealer as we improve our software. Call us on our Customer Support line if you have a question, to see what new programs support more memory, or to tell us your suggestion for improving our hardware or software. We listen to you. We respond. MultiRam™ RGB is just one example of what we do when we listen!

Ask your dealer for MultiRam™

From \$199.95 with 64K
RGB cable extra

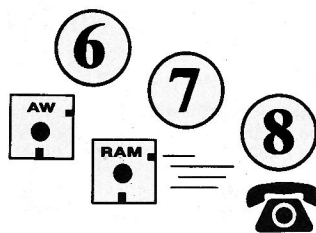

Checkmate Technology

509 S. Rockford Dr. • Tempe, AZ 85281
(602) 966-5802 • (800) 325-7347
MCI Telex: 6502788652

In Canada Contact EDP Marketing (403) 482-3014

APPLE CLINIC

by Jim Sather

Apple Clinic is a forum for discussing Apple II hardware, software, and related subjects. If you have questions or answers, or want to make a statement, write to Jim Sather, Apple Clinic, inCider, 80 Pine Street, Peterborough, NH 03458.

Sams Computerfacts

I received some samples of Sams Computerfacts for Apple-related equipment this month (see Ralph Olson, September 1985, and Dallis J. Christensen, February 1986, letters to Apple Clinic). I'm impressed. For years, Sams has been in the business of providing information on home electronic appliances to service technicians. All American TV technicians are familiar with Sams Photofacts. Computerfacts are Photofacts for computers and peripherals.

A typical Computerfact package is about 30 pages long, and contains schematics with test points and waveform pictures, location photos, IC pin-outs, parts information, and alignment and checkout procedures for the equipment covered. They're excellent guides for technicians who need to repair unfamiliar equipment. As such, they would also be very useful to Apple Clinic readers who aren't technicians, but have some knowledge of electronics and want to attempt to repair their malfunctioning equipment.

Computerfacts aren't without weaknesses. For example, the Apple II/III Plus Computerfact poorly documents revisional differences, and provides waveforms and logic-probe tables only for RFI-revision Apples with Integer BASIC in ROM. The greatest strength of Computerfacts is that they often contain information that's unavailable elsewhere to the general public. Where else can you get a schematic of an ImageWriter printer?

Computerfacts are available for the Apple IIe, IIc, II/III Plus, Disk II drive, several printers and monitors, and a variety of other computing equipment. The Disk II Computerfact has alignment/test procedures for use with a Dysan alignment disk (not included).

Write Sams (see the accompanying Product Information box) for a list of available Computerfacts.

//e Enhancement and Peripherals

It's true that an Apple Super Serial interface isn't required for a printer to work with an enhanced Apple IIe. Your statement that "any printer-interface card that works with the old Apple IIe firmware will work in an enhanced Apple IIe" (November 1985, p. 46) is incorrect, though.

My Gemini 15X printer and Tymac PPC interface card quit working with some programs when I enhanced my Apple IIe. I called the Creative Peripherals Unlimited customer-service number, and the people there told me that others had experienced the same problems with that interface card. I installed an Apricorn interface card, and all programs printed perfectly.

The enhanced firmware is incompatible with my old interface card. Please advise others to check not only for software compatibility prior to enhancement, but also for compatibility with peripheral cards.

Stephen P. Dwyer
Fort Eustis, VA

I stand corrected. It's always possible that a change in Apple firmware will cause compatibility problems with some peripheral cards. Most older Apple IIe cards, however, do work with the enhanced IIe. Thanks for the information, Stephen.

Stuck with European Apple

I have an international Apple IIe with a Rev A motherboard I can't get Apple to convert to Rev B. I'm in the Navy and bought the unit while stationed overseas. When I found out that Apple was upgrading all Rev A models to Rev B, I took mine to my Apple dealer, only to be told it couldn't be done, since its international guts were different.

This doesn't seem right to me, since I didn't know I had bought an irregular Apple. I even wrote a letter to the president of Apple, but received no reply. I want to get the re-

vision so that I can install a 65C02 and use a color monitor (apparently the color signal is different on my Apple).

I've gotten nowhere with this problem and would appreciate any help you can give. Maybe Apple will at least talk to you.

J. Adcock
Monterey, CA

The Rev A/Rev B situation is a little different for European Apples than for American Apples. Briefly, you've got all the features on your Rev A European Apple that you'd get by converting an American Apple from Rev A to Rev B. In other words, you already have double high-resolution graphics capability. You don't need Rev B—you need an American Apple IIe.

Conversion by Apple is out of the question. The Apple IIe simply wasn't designed to be converted from European to American and vice versa. You can perform a limited conversion by installing an American IOU and 14.31818 MHz crystal on your motherboard. This will make your Apple scan at American TV frequencies, so you can use it with a transformer and American monochrome monitor. You can't drive an American color TV or monitor with your Rev A or Rev B European Apple, though. You might also get an unpleasant flickering effect if your Apple doesn't have the color/mono switch, which wasn't present on the earliest European Apples.

I'm sorry for this rather gloomy assessment of your situation, but your best solution is to sell the European machine and buy an American Apple. Perhaps one of inCider's many overseas readers will see this and make an offer. Maybe someone has the opposite problem and is interested in a swap. I'll be happy to forward any offers I receive.

I hope other readers can benefit from Lt. Adcock's story. Americans temporarily overseas should buy American Apples and use them over there with a transformer and NTSC display device. Barring that, Americans should sell their European Apples overseas when they find they're returning to the States permanently. It's hard to switch over once you come home.

Incidentally, you don't need Rev B to install a 65C02. The 65C02 will work in any Apple IIe purchased anywhere.

Descrambling Video

With the recent talk about scrambling almost all signals you can receive through a satellite down-station TV antenna, I was wondering if there's some way my Apple II Plus could act as a descrambling device. If it could, would you know where I could obtain a program for this?

Robert L. Rogers, Jr., M.D.
Lenoir, NC

I'm not an expert in satellite TV scrambling, but I'm pretty sure that no program can make the Apple descramble satellite TV signals. Video-signal scrambling/descrambling is accomplished in real time at speeds far exceeding the Apple's ability to sample and process. High-frequency signal processing is a job for fast analog circuits, not stored-program digital computers.

Video descrambling circuitry could be engineered to work in an Apple peripheral slot, and it's truly amazing what smart engineers can do with an Apple peripheral card. I know of no video-descrambling cards available for the Apple, though.

Whatever It Takes

In the December 1985 Apple Clinic, you advised David Swain (p. 102) to use printer code in the format PRINT CHR\$(9);"GR". My DEC LA-34 printer doesn't respond to code in that format. Although it doesn't make sense to me, I have to write that statement as PRINT CHR\$(9) + "GR". My printer commands don't work unless I build up the strings via plus-sign concatenation. I hope this information will be useful to other users.

Raymond J. Schuerger, D.V.M.
Pittsburgh, PA

Your results make no sense to me, either, Raymond. PRINT CHR\$(9); "GR", PRINT CHR\$(9)"GR", and

PRINT CHR\$(9) + "GR" all make your computer send the same character string—\$89 \$C7 \$D2 \$8D—to the active character output driver (COUT). The only difference is a slight variation in time between characters. If your printer or interface card is sensitive to that variation, you probably have some sort of circuit malfunction.

Lots of things I don't understand work. If PRINT CHR\$(9) + "GR" is necessary for correct operation of your interface card and printer, use it. I just want any reader out there who understands it to write and tell the rest of us why it works.

AppleWorks Printouts

I own an enhanced Apple IIe, Apricorn Graphics Printer Interface, and Panasonic KX-P1091 printer. I use AppleWorks extensively in my day-to-day business activities. My problem is that every line of my AppleWorks printouts has a P at the far left. The Apricorn people sent me a new card, but the problem still exists. They think

SENSIBLE GRAMMAR™

Yes, just like your old English teacher, your Apple Computer can now check your papers for grammatical and many other writing errors. Don't be embarrassed or lose credibility because of simple typos and mistakes. And it's so easy and fast to do with **Sensible Grammar**.

SENSIBLE GRAMMAR checks your grammar, capitalization, punctuation and abbreviations. It searches out phrases that are inconcise, vague, wordy or repetitive, as well as faulty, informal, pompous or sexist. It calls your attention to cliches and slang. It even allows you to enter your own personal trite and pet expressions and then lets you know every time you use them.



AppleWorks Compatible!

*Sensible Grammar and Sensible Speller ProDOS work with the following word processors, AppleWorks, AppleWriter ProDOS version (Apple Computer, Inc.); Format II Enhanced-ProDOS (Kensington Microware), Mouse Write (Roger Wagner Publishing), Word Juggler (Quark Inc.), Zardax-ProDOS (Computer Solutions) and others. Sensible Speller ProDOS also works with PFS:WRITE-ProDOS (Software Publishing, Inc.); Mouse Word (International Solutions), Word-Talk (Computer Aids) and WordPerfect (SSI Software). Sensible Speller IV works with DOS 3.2 and DOS 3.3-AppleWriter (Apple Computers, Inc.); Bank Street Writer (Brodebund); Format II (Kensington Microware); Home-Word & Screen Writer (Sierra On-Line Inc.); PFS:WRITE-DOS (Software Publishing, Inc.); TFCP-M-Wordstar (Digital Research Corp.-Micropro International), and others. Owners of trademarks indicated in parentheses. Black's Law Dictionary (West Publishing, Inc.); Stedman's Medical Dictionary (Waverly Press, Inc.).

†Note: C.P.M., Pascal and PFS:WRITE-DOS versions do not suggest correct spelling of words or allow immediate correction of misspellings.

do you exhibit a tendency to
make punctuation errors?
Regardless of your skills,
typographical errors occur.
Therefore Sensible Grammar

It Never Overrides Your Judgment
Sensible Grammar singles out possible mistakes or improper usage and then suggests a correct replacement word or phrase, but it always leaves you the option to accept or reject the suggestion.

A Perfect Complement
SENSIBLE SPELLER™ catches your spelling mistakes, utilizing its huge 80,000 word vocabulary derived from the official Random House Dictionary®. Like **Sensible Grammar**, it works with tireless efficiency. It displays misspelled words in context, suggests the correct spelling and allows immediate replacement of misspelled words with correct ones.

Black's Law Dictionary™, **Sensible Technical Dictionary™** and **Stedman's Medical Dictionary™** are also available separately on diskette for use with the Sensible Speller.

Sensible Grammar™ is available for \$99.95; **Sensible Speller™** for \$125.00 in either the "IV" or ProDOS version; **Sensible Technical Dictionary™** for \$69.95; **Stedman's Medical Dictionary™** for \$99.95; and **Black's Law Dictionary™** for \$99.95. The three specialized dictionaries require the **Sensible Speller**. All programs are available separately and run on Apple® computers.

Sensible Software, Inc.
210 S. Woodward, Suite 229, Birmingham, MI 48011 • (313) 258-5566

SILICON EXPRESS DISKS
SS/IDD 9.95
DS/IDD 10.95

VERBATIM OR MAXELL
SS/IDD 14.00
DS/IDD 18.45

ELEPHANT
SS/SD 11.45
SS/IDD 11.95
DS/IDD 15.50

DATABASE
8.99

INSIDE OHIO
1-800-225-0755
YOUR TOLL FREE ACCESS OUTSIDE OHIO
1-800-228-0755
CALL...FOR THE BEST PRICES...
BEST DELIVERY...
We have hundreds of other programs in stock at Fantastic savings.

SILICON EXPRESS
ALL NEW STORE WITH EXPANDED WAREHOUSE

Ability 299.95
ASC II Express 132.95
Bank Street Writer 52.95
Clout 119.95
Copy II Option Bd. 74.00
Cornerstone 259.95
Crosstalk 94.95
dBase III+ 369.95
Deadline Manager 104.95
Dollars & Sense 104.95
Easy 97.50
Einstein Writer 118.95
Electric Disk 239.95
Family Roots 149.95
Fontrix 1.5 84.95
Fntpk1 1 thru 13 ea. 13.00
Framework II 39.95
Gamecard III 39.95
Gato 23.69
In House Accountant 119.95
Jet 32.95
KnowledgeMan 2.0 319.95
Lotus CALL 239.95
Mnngng Yr Money 104.95
Micro Cookbook 25.95
Microsoft Chart 2.0 299.95
Word 239.95
Windows 69.95
Morton Utilities 55.95
PFS: Access 59.95
PFS: Files 82.50
PFS: First Success 229.95
PFS: Graph 82.50
PFS: Plan 82.50
PFS: Proof 59.95
PFS: Report 82.50
PFS: Write 82.50
Print Shop 36.95
Print Shop Gr. #1 22.95
Print Shop Refill 13.95
R:Base 5000 339.95
Reflex 56.95
Remote 94.95
Report Card 33.00
Samma + 369.95
Sidekick protected 29.95
Sidekick not protected 47.95
Sideways Ver. #3 48.95
Speedkey 104.95
SuperCalc 3 239.95
Superkey 36.50
Sprky/Sidek. Combo 67.95
Symphony CALL 99.95
Think Tank 76.99
Time Is Money 36.95
Traveling Sidekick 38.95
Turbo Database Tlbx 45.95
Turbo Lighting 36.50
Turbo Pascal 3.0 59.95
Turbo Tutor 24.95
Ultima III 34.95
Visible 8088 49.95
Volkswriter Dix #3 159.95
Web. Spell Checker 41.95
Will Writer 31.95
Wizardry 39.95
Word Perfect 219.95
Wordstar 214.95

APPLE SOFTWARE

Adv. Construction 30.75
Algebra 34.95
Alpha Plot 24.89
ASC II Express 74.00
Bag of Tricks 2 28.00
Bank Street Filer 39.50
Bank Street Mailer 39.50
Bank Street Writer 39.50
Bank Street Speller 39.50
Bard's Tale 28.50
Beagle Bag 15.00
Beagle Basic 18.50
Beagle Graphics 30.50
Beneath Apple DOS 13.50
Big U 17.00
Bookends 67.00
Captain Goodnight 20.00
Carmen Sandiego 23.00
Chmpshp Ld. Runner 19.85
Chart'n Graph Tlbx 23.95
Chopliker 19.85
Computer Quarterback 27.95
Crossword Magic 30.00
Crypt of Medea 21.95
Database Toolbox 23.95
Dazzle Draw 34.50
D-Code 21.00
DiskQuick 15.50
Dollars & Sense 66.00
DOS Boss 12.25
Double-Take 18.00
Eidolon 23.50
Essential Data Dup 43.50
Extra K 21.00
Family Roots 149.95
Fantavision 27.00
Fat Cat 18.50
Flex Type 15.50
Fontrix 1.5 53.25
Fntpk1 1 thru 13 ea. 13.00
Font Mechanic 15.00
Font Works 34.95
Forecast 36.00
Frame-Up 15.00
Gato 21.00
G I Joe 20.00
Graphics Department 64.75
Graphics Expander 22.25
Graphworks 58.00
GPLE 25.50
Handler Package 69.95
Impossible Mission 23.50
I.O. Silver 15.00
Jeeves 29.95
Karateka 19.95
Knight of Diamonds 20.50
Kids on Keys 17.95
Kid Writer 18.89
King's Quest I or II 29.95
Koronis Rift 23.50
Legacy of Lylgamy 23.50
List Handler 44.00
Locksmith CALL
Mnngng Yr Money 102.00
Mathmaze 27.95
Megaworks 79.95
Merlin 33.75
Merlin Pro 55.75
Merlin Combo 63.95
Micro Cookbook 22.25
Millionaire 23.25
Minipix 14.75

APPLE SOFTWARE

Moebius 41.95
MouseWrite 72.00
Multiplan DOS 3.3 65.95
Munch-A-Bug 23.95
NATO Commander 19.75
PFS: Plan 69.95
PFS: Access 44.00
PFS: Write 69.95
PFS: File 69.95
PFS: Report 69.95
PFS: Graph 69.95
PFS: First Success 126.00
Piece of Cake Math 21.95
Pinpoint 39.95
Prince 48.95
Printographer 23.95
Print Shop 26.75
Prt Shp Gr. #1.2. or 3 14.25
Print Shop Comp. 21.50
Probyter 18.50
Pronto DOS 15.00
Prof. tour golf 25.89
Quicken 51.95
Report Card 33.00
Rescue/Fractalus 23.50
Reportworks 84.95
Rescue Raiders 24.95
Science tool kit 33.00
Sensible Grammar 59.95
Sensible Speller 64.95
Shape Mechanic 23.95
Sideways 32.00
Silicon Salad 12.75
Skyfox 24.50
Spellworks 31.50
Spitfire Simulator 24.75
Sticky Bear ABC 23.75
Basket Bounce 23.75
Car Builder 23.75
Math 23.75
Numbers 23.75
Opposites 23.75
Reading 23.75
Spellgrabber 23.75
Townbuilder 23.75
Typing 23.75
SuperCalc 3A 109.95
Terrapin Logo 59.95
Think Tank 88.99
Time is Money 57.50
Tip Disk #1 12.50
Transylvania 21.89
Triple-Dump 20.00
Turbo Database Tlbx 28.00
Turbo Pascal 3.0 35.00
Turbo Tutor 20.50
Typefaces 10.75
Ultima III 33.69
Ultima IV 41.95
Understanding IIE 17.95
Understanding II+ 15.95
Universal file conv 24.95
Utility City 15.25
Versaform 43.50
Video Toolbox 23.95
Visible 6502 31.75
Wilderness 38.95
Winter Games 23.50
Wizardry 26.50
Wizard's Toolbox 23.95
Wizprint 15.99
Word Handler 44.00
Word Perfect 125.95
World's Grst Ftball 23.50
Write Choice 26.95

COMMODORE

Acrojet 24.95
Air Rescue I 24.95
Bard's Tale 29.95
Ballblazer 23.50
Back to Basics 134.95
Bank Street Storybook 27.95
Bank Street Speller 34.95
Bank Street Writer 34.95
Basic Toolkit 29.95
Blazing Paddles 24.95
Brwed Time 64/128 20.95
Color Me 20.95
Cndwn to Shdwn 29.95
Crossword Magic 34.95
Fast Tracks 20.95
Gertrude's Secrets 20.95
G I Joe 20.00
Graphics Magician 27.95
Grappler CD 84.95
Hacker 20.95
Jet 64/128 27.95
Jet Combat Simulator 20.95
Karateka 19.95
Kennedy Approach 24.95
Kola Pad 54.95
Kung Fu 20.95
Little Comp. People 24.95
Mail Order Monsters 23.50
Merlin 34.95
Mig Alley Ace 24.95
Multiplan 64/128 43.95
Music Shop 31.95
Nato Commander 24.95
Paper Clip 62.95
PFS: File 54.95
Print Shop 31.95
Pr. Shop Gr. 1.2. or 3 14.25
Rescue on Fractalus 24.95
Road Race 20.95
Scrabble 64/128 27.95
Sideways 20.95
Silent Service 24.95
Spitfire Ace 20.95
Spreadsheet 34.95
Spy vs. Spy 20.95
Sticky Bear ABC 23.75
Numbers 23.75
Opposites 23.75
Shapes 23.75
Summer Games I or II 23.00
Temple of Apsah Tril. 23.00
Winter Games 23.50
World's Grst Bsbll 23.50
World's Grst Ftball 23.50

Baron 23.25
Clip Art (Vol 1) 16.25
Clip Art (Vol 2) 22.25
Copy II+ 18.50
Crusade in Europe 27.95
Cut & Paste 23.00
Cutthroats 23.69
Deadline 28.00
Early Games 19.95
Easy as ABC's 27.95
Enchanter 23.69
Flight Sim II 33.89
Fraction Factory 19.95
F-15 Strike Eagle 20.00
Ghost Busters 23.00
Hitchhiker's Guide 22.00
Infidel 26.00
Load Runner 19.85
Magic Spells 20.75
MasterType 24.89
Math Blaster 27.50
Micro Lg. Baseball 23.00
Micro Lg. Manager 27.95
Micro Lg. Team 13.95
Mind Forever Voy. 30.95
Music Construction 24.99
Newsroom 30.50
One-On-One 24.50
Pitstop II 23.50
Planefall 22.00
Print Shop Refill 12.25
Reader Rabbit 25.95
Sargon III 27.25
Sat (Harcort Brace) 46.99
Seastalker 22.00
Sorcerer 26.00
Squire 23.75
Solo Flight 20.00
Speed Reader II 37.50
Spell It 27.50
Spy Hunter 26.00
Starcross 28.0
Suspect 26.00
Suspended 28.00
Temple of Apsah Tri 23.00
Tycoon 23.50
Typing Tutor III 29.75
Will Writer 28.50
Wishbringer 27.95
Witness 22.00
Word Attack 27.50
Word Spinner 23.95
World's Grst Bsbll 23.50
Zork I 22.00
Zork II or III 25.00

HARDWARE

CompuServe Starter 21.95
Database 8.99
Disk Notcher 8.95
Flip-n-File 14.95
Lemon 31.95
Lime 48.95

APPLE HARDWARE

80 Col. 64K Card 49.95
Apple Cat II 187.00
Gibson Light Pen 148.00
Grappler Buffered 131.00
Grappler + 72.00
Grappler (serial) 72.00
Grappler C 72.00
Hotlink 54.99
Kraft Joystick 26.0
Koala Pad + 70.50
Mach II Joystick 26.25
Mach III Joystick 32.25
Micromodem IIE 139.95
Microsci A2 Drive 144.95
Microsci IIC Drive 149.95
Mockingboard A or B 66.00
Mockingboard C 116.50
Mockingboard D 126.00
Mockingboard A-MAX 39.00
Multiram IIC 512K 279.00
Microsci IIE 80/64K 129.00
Multiview II + 80/160 205.00
Paddleticks 26.50
Parallel Printer Card 54.95
Prometheus 1200A 255.00
Print-it 128.00
Super Serial Card 90.95
System Saver Fan 59.95
Thunder Clock 103.00
Wildcard 2 74.95
ZEE 80A Checkmate 69.95
Zoom IIE 109.00

PRINTERS

Star SG-10 219.00
Star SG-15 394.99
Star Powertype 344.95
Printer Stand 16.95
Okidata 182P 229.95
Okidata 192P 399.95
Okimate 20 209.95
Colored prntr ribbons CALL
Color Paper Pack 13.95

MONITORS

Amdek Color 300 199.95
Amdek Color 600 414.99
Amdek Video 300G 127.99
Amdek Video 300A 137.99

YOUR ORDER FORM
SILICON EXPRESS

5955 E. Main Street Columbus, Ohio 43213

NAME _____

ADDRESS _____

CITY _____ STATE _____ ZIP _____

CHARGE CARD # _____ Exp. Date _____

QTY.	DESCRIPTION	PRICE

Computer Type _____ SHIPPING _____

Phone No. _____ TOTAL _____

No additional surcharge on Mastercard, Visa, or School purchase orders. Personal checks allow 2 weeks. Shipping charges are \$2.50 minimum. Ohio residents add 5 1/2% state sales tax. Prices subject to change without notice.

SILICON EXPRESS

5955 E. Main St. Columbus, Ohio 43213

1-614-868-6868

something's probably wrong with my printer.

Is this problem a function of the AppleWorks program? I'm afraid to buy new word-processing programs until I know what's happening. Can you please advise me as to the best course of action?

Arthur S. Connor, Jr.
Fort Riley, KS

Your letter shamed me into figuring out why my own KX-P1091-compatible printer was producing junk at the left margin with AppleWorks. AppleWorks doesn't do much for me personally, so it hadn't been worth the hassle. This is just my opinion, but I think the AppleWorks scheme of canned printer support really fails. It doesn't support enough printers, and doesn't support all the features of some models with which it's compatible (for example, italics and mid-line switching of character pitch). If the canned printer support is going to be so poor, I'd much rather use Apple Writer's embedded control characters for printing.

You didn't tell me the printer information you specified in AppleWorks. This is probably the cause of your problem. The following configuration works with the 1091. (Consult chapter 13 and Appendix B of your AppleWorks reference manual for details if you don't know how to specify printer information.)

Add a printer to the AppleWorks list, and specify the custom-printer option. Set the interface-card control string to whatever works with your interface card. Control-I-zero-N and "none" both work with my Grappler+. Try them with your Apricorn. The default control-I-80-N might also work. Type in the printer information in **Table 1**, based on data from the 1091 reference manual. You can find control codes for other printers in their respective manuals.

AppleWorks sends the current character-pitch control code at the beginning of every printed line. For this reason, the single-line double-width control code, control-N, is appropriate. This also explains why you get a P at

the left side of each line. AppleWorks is sending incorrect character-width code for your printer at the beginning of each line, and the printer responds by producing a P.

Table 1. AppleWorks KX-P1091 custom-printer information.

Functions	Control Code
bold on/off	ESC,G/ESC,H
alternate bold (italics)	ESC,4/ESC,5
superscript on/off	ESC,S,0/ESC,T
subscript on/off	ESC,S,1/ESC,T
underline on/off	ESC,-,1/ESC,-,0
1/4-inch line space	ESC,2
1/2-inch line space	ESC,0
5 characters/inch	ESC,P,CTRL R,CTRL N
6 characters/inch	ESC,M,CTRL N
8 characters/inch	ESC,P,CTRL O,CTRL N
10 characters/inch	ESC,P,CTRL R
12 characters/inch	ESC,M
17 characters/inch	ESC,P,CTRL O

MacroWorks™ makes AppleWorks™ work the way it should have in the first place.

New word processing power
MacroWorks streamlines AppleWorks word processing with a multitude of new features. For example, one quick keystroke now deletes the *character* or the *word* at the cursor.

Return to our *sanctuary* office: *Macros let you type almost anything with just one keystroke.*

Harvey R. Smith
6502 Disk Drive
Uptown, CA 92103

Use one keystroke* to jump to the start or end of a line of text. Another keystroke will erase an entire line. Change your mind? Apple-U will instantly "Undo" your last delete command!

AppleWorks Macros

MacroWorks will convert any series of keystrokes into a new one-keystroke AppleWorks command. Use MacroWorks' built-in macros, or define your own. For example, make Apple-N type your name and address. Or let Apple-X Save or Print all of your desktop files, nonstop.

For AppleWorks' Word Processor, Data Base and Spreadsheet

The possibilities are endless. For example, you may want to skip unwanted questions like "How many copies?" and "Are you sure...?". Or search and replace printer commands (change all underlined words to bold, etc.).

* These are Solid-Apple commands. All original commands stay intact.

Boot AppleWorks and go

MacroWorks is *not* a time-consuming "pre-boot" disk. You boot AppleWorks like you always do, but now you've got MacroWorks' new features!

Customized Help!

MacroWorks lets you replace AppleWorks' Help screens with new information, like a list of new commands or important names and addresses.



3990 Old Town Avenue, San Diego, California 92110
MacroWorks requires AppleWorks and an Apple IIc or 128K IIe.
AVAILABLE AT MOST SOFTWARE STORES or by mail:
Visa, MasterCard or COD orders, phone toll free
1-800-227-3800 ext. 1607

Multi-Column Printouts!

MacroWorks' *Galley* program prints your AppleWorks word processing files in side-by-side columns (two or three-wide) for faster and easier newsletter layouts.

Analyze your files

MacroWorks' *File Analyzer* program prints a sorted list of every word it finds, and reports the number of occurrences of each word, and the average word length. Great for making an index or glossary, or for analyzing your writing style.

• COUNT WORD	• 1 WORK
• 10 A	• 1 WRITING
• 1 ADDRESS	• 9 YOU
• 1 ADDRESSES	• 1 YOU'VE
• 6 ALL	• 8 YOUR
• 1 ALMOST	• TOTAL WORDS: 402
• 1 ALWAYS	• CHARACTERS: 2013
	• CHARS/WORD: 5.0

Alphabetize your catalogs

MacroWorks' *Alpha-Cat* program prints a sorted list of all the files (or just the AppleWorks files) on a disk. Perfect for disk I. D. labels!

\$34⁹⁵ Friendly and unprotected

MacroWorks is easy-to-use, unprotected and compatible with all Apple IIc's and 128K IIe's. Like all Beagle Bros disks, you can make backups without hassle or special software.

Apple, AppleWorks and ProDOS are trademarks of Apple Computer, Inc.

Six Meg 16-Bit IIe

Why pay more for a lesser card, that doesn't offer battery backed-up RAM, just because it's advertised a lot? Who do you think **really** pays for all those ads? You can buy Checkmate Technology's **State-Of-The-Art MULTIRAM RGB RAM CARD™** that works 100% in 8-Bit, has a **PORT FOR OPTIONAL BATTERY BACKED-UP RAM**, optional **real 16-Bit 65C816 slot saver Co-Processor card**, **FREE RGB***, & soon, **BATTERY BACKED-UP STATIC RAM** options that can load & save entire programs, like AppleWorks, for 10 years!

- **MULTIRAM IIe IS A DIRECT SUBSTITUTE FOR RAMWORKS II™ or Apple Ext 80 column cards. It RUNS ALL (100%) 3rd PARTY SOFTWARE** that the others do, and unlike Ramworks II, fits ALL (even Euro) Apples.
- **TWO MAIN BOARDS TO PICK FROM** both with 16-Bit port, sharp 80 columns & Double Hi-Res. **Multiram RGB** also has a **STATIC RAM PORT** & expands to 1 Meg main RAM + 3 Meg piggyback RAM + 2 Meg **BATTERY BACKED-UP RAM**. **MultiRam IIe** expands to 768k and can piggyback with MultiRam RGB. And **UNLIKE RAMWORKS II**, there is never a chance to touch cards in Slot 1 (such as Super Serial Card). **A POSSIBLE 6 MEGABYTES IN ONE SLOT - 50% MORE THAN RAMWORKS II.**
- **OPTIONAL 16-Bit 65C816 CO-PROCESSOR CARD** that plugs into MULTIRAM using no slots! **TRULY STATE-OF-THE-ART, BUT IT CAN'T RUN ON RAMWORKS™!**
- **FREE APPLEWORKS TIME/DAY/DATE ON-SCREEN, FREE AUTO-COPY (disk to RAM). FREE ULTRA-FAST RAM DISK** that can be run alone or WITH APPLEWORKS. **FREE RAM TEST** & optional CP/M & Pascal Ram disk!
- **FREE APPLEWORKS EXPANDER SOFTWARE** that modifies AppleWorks once-loads ALL (even printer routines) or PARTS of AppleWorks into memory, runs 30 x faster, increases Desktop over 2048k, auto-segments large files onto multiple disks, stores over 5350 records, **DOUBLES** word processor lines! An increased Clipboard due soon.
- **15 DAY MONEY BACK SATISFACTION GUARANTEE, FREE SOFTWARE UPDATES, FREE 64k MEMORY WITH EACH 256k/512k CARD, & QUANTITY DISCOUNTS FROM COIT VALLEY COMPUTERS. EXCLUSIVE 5 YEAR WAR-**

RANTY THAT, UNLIKE RAMWORKS, INSURES COVERAGE NO MATTER WHERE YOU BOUGHT IT! CALL FOR CURRENT PRICES, QUANTITY DISCOUNTS, NEW FEATURES OR DETAILS ON CHECKMATE'S DIRECT \$50 REBATE FOR OLDER CARDS!

		MultiRam RGB	MultiRam IIe
64k	MULTIRAM	185.	147.
128k	MULTIRAM	203.	168.
320k	MULTIRAM	222.	189.
576k	MULTIRAM	272.	237.
768k	MULTIRAM	322.	287.
1024k	MULTIRAM	372.	
1280k	MULTIRAM	520.	
1536k	MULTIRAM	548.	
1792k	MULTIRAM	578.	
256k Memory Expander Chips (8)		55.	
Apple IIe Enhancement Kit		62.	
Clockworks			
(Thunder/Time H.O.™ compatible)		89.	
Pico™ Slimline Drive IIc, IIe, II+		178.	
65C816 Co-Processor Card		162.	
RGB Connector (card to Apple)*		19.	
Pinpoint Software		49.	
CP/M or Pascal Ram Disk (each)		20.	
Accelerator IIe-speedup card		249.	

CALL FOR OTHER APPLE PERIPHERAL PRICES.

640k 16-Bit IIc!

Checkmate Technology's **State-Of-The-Art IIc** cards easily expand your IIc up to 640k, are 100% compatible with all IIc software/hardware, & come with the **SAME FREE SOFTWARE** as **MULTIRAM IIe**. **MULTIRAM C** is non-upgradable & **MULTIRAM CX** can be upgraded with a 16-Bit 65C816 kit to likely run software for the new Apple computer! **CALL FOR CURRENT PRICING & QUANTITY DISCOUNTS!**

- **NO JUMPER WIRES, CLIPS TO ATTACH, OR DRIVE REMOVAL REQUIRED FOR INSTALLATION. ALL CHIPS ARE SOCKETED AND REMOVABLE**-unlike the competition.
- **USES ABOUT 50% LESS POWER** than the competition-causing less power supply strain or battery pack drain!
- **15 DAY MONEY BACK SATISFACTION GUARANTEE** from Coit Valley Computers. **5 YEAR WARRANTY** THAT, UNLIKE THE COMPETITION, **INSURES COVERAGE NO MATTER WHERE YOU BOUGHT IT!**
- **LOWER PRICES**-We sell IIc cards for much less and our software updates are free, while they usually charge \$10 or more!

		LOWER OUR LOW PRICE
256k	MULTIRAM C	224.
512k	MULTIRAM C	264.
256k	MULTIRAM CX	278.
512k	MULTIRAM CX	318.
16-Bit 65C816 CX Kit (\$10 less with card)		135.
IIc System Clock (Same as A.E.)		66.
IIc Battery Pack & U.P.S.		174.
C-VUE Flat Panel Display (\$10 less with card)		439.

Terms: Add \$4-Ground or \$6-Air shipping & phone # to each U.S. order (foreign orders extra). Add 3% for P.O.'s (3% 7 net 30) & MasterCard/Visa (include #/expir). For fast delivery send Cashier's/Certified check, Money Order. C.O.D. (add \$5) & personal checks accepted (allow 16 days). Tex res add 6 1/2% tax. **CALL FOR CURRENT PRICES & QUANTITY DISCOUNTS! SCHOOLS & GROUPS WELCOME.**

MULTIRAM, Ramworks/Ramworks II/TimeMaster II H.O., Pico, respective trademarks of Checkmate Technology, Applied Engineering, WGE.

COIT VALLEY COMPUTERS
14055 Waterfall Way

(214) 234-5047
Dallas, Texas 75240

GOLEM COMPUTERS

APPLE SOFTWARE/HARDWARE AT SUPER SAVINGS

PLACE ORDERS TOLL FREE

1-800-345-8112

PA 1-800-662-2444



LIST PRICE GOLEM PRICE

HARDWARE SPECIALS

212 APPLE CAT II SYSTEM (NOVATION)	365.00
MICROMODEM IIE/SMARTCOM I (HAYES)	135.00
SMARTMODEM 300/SMARTCOM IIC (HAYES)	155.00
SMARTMODEM 1200 RS-232 (HAYES)	374.00
PROMODEM 1200A W/SOFT (PROMETHEUS)	284.00
PROMODEM 300C IIC (PROMETHEUS)	135.00
MACH III JOYSTICK W/FIRE BUTTON (CH PROD)	32.00
BUFFERED GRAPLER - (ORANGE MICRO)	136.00
PRINTER KX-1091 (PANASONIC)	242.00
PRINTER MSP-10 (CITIZEN)	250.00
DISK DRIVE SLIM IIC (MICROSCI)	165.00
MONITOR VIDEO 300A AMBER (AMDEK)	127.00
BLANK MEDIA SS/DD 10 (GOLEM)	11.00

EDUCATION

TYPING TUTOR III	49.95	29.70
MATH BLASTER!	49.95	29.70
TURBO TUTOR	34.95	23.10
MASTER TYPE	39.95	23.60
MIND PROBE	49.95	29.70
WORD ATTACK!	49.95	29.70
WHERE IS CARMEN SAN DIEGO	39.95	23.65

HOME

DOLLARS AND SENSE II-/IIC 64K	100.00	59.00
DOLLARS AND SENSE IIC/IIC 128K	119.95	66.00
CROSSWORD MAGIC	49.95	30.10
NEWSROOM	49.95	29.70
CLIP ART VOL 1 FOR NEWSROOM	29.95	18.20
MICROCOOK BOOK	40.00	23.60

UTILITIES

THE PRINT SHOP	49.95	29.60
THE PRINT SHOP GRAPHICS I, II	ea. 24.95	14.25
SIDEWAYS	60.00	33.00
TURBO PASCAL	69.95	41.35
TURBO TOOLBOX	54.95	35.20
CROSSTALK	195.00	138.70

WORD PROCESSING

SENSIBLE SPELLER IV	125.00	66.00
HOMEWOR	125.00	70.00
PFS: WRITE IIC	125.00	70.00
BANK STREET WRITER	69.95	41.30
BANK STREET SPELLER	69.95	41.30
WORDSTAR	350.00	197.90

BUSINESS

PFS: REPORT, FILE, GRAPH	ea. 125.00	70.00
BACK TO BASICS ACCT. SYS. IIC	195.00	97.90
THINK TANK	150.00	80.00
BPI GA, AP, AR PAYROLL (PRO DOS)	ea. 425.00	250.00

RECREATION

GATO	39.95	23.35
SARGON III	49.95	29.70
FLIGHT SIMULATOR II	49.95	31.90
WISHBRINGER	39.95	23.35
SPY HUNTER	44.95	26.65
KARATEKA	39.95	21.00
F-15 STRIKE EAGLE	34.95	21.00
ZORK I	39.95	23.35
ZORK II, III	ea. 44.95	26.65
LODE RUNNER	34.95	21.00
ULTIMA II, III	ea. 59.95	35.50
WIZARDRY	44.95	29.70
HITCHHIKERS GUIDE	39.95	23.60
LEGACY OF LLYLGAMYN	39.95	23.60
KNIGHT OF DIAMONDS	34.95	20.90
KING'S QUEST	49.95	29.60
DRAGON WORLD	39.95	23.60

PLACE ORDERS TOLL FREE

1-800-345-8112 • PA 1-800-662-2444

ALL ITEMS SUBJECT TO AVAILABILITY
PRICES SUBJECT TO CHANGE WITHOUT NOTICE

To order call toll free or send check or money order VISA/MC C.O.D. orders welcome. Personal and company checks allow 10 working days to clear. Specify if to backorder or to send refund. California residents add 6% sales tax. Include phone number with order. Shipping and handling: All shipments U.P.S. if possible. Continental U.S. add \$2.50 for 1 to 3 items, 4 to 6 items add \$5.00. APO, FPO Alaska, Hawaii and Canada add \$3.00 per item. 2nd day air add \$3.00. All hardware purchases are prepaid or VISA/MC; shipped U.P.S. - include 5% for shipping & handling. C.O.D. orders all \$1.90. Mail orders to:

GOLEM COMPUTERS

P.O. BOX 6698 • WESTLAKE VILLAGE, CA 91359

Apple is a trademark of Apple Computers, Inc.

APPLE CLINIC

Table 2. Epson FX to KX-P1091 AppleWorks patch.

Location*	Was	Is
\$28ED	1B 40 1B 3D	1B 40 12 12
\$28F2	1B 70 31	12 1B 6F
\$28F6	1B 70 30 12 1B 50 0E	1B 50 12 0E 0E 0E 0E
\$28FE	1B 70 30 12 1B 4D 0E	1B 4D 0E 0E 0E 0E 0E
\$2906	1B 70 30 1B 50 0F 0E	1B 50 0F 0E 0E 0E 0E
\$290E	1B 70 30 12 1B 50	1B 50 12 12 12 12
\$2915	1B 70 30 12 1B 4D	1B 4D 12 12 12 12
\$291C	1B 70 30 1B 50 0F	1B 50 0F 0F 0F 0F

*SEG.PR file BLOADED to \$2000

AppleWorks doesn't let you specify proportional-print on/off for custom printers, so you can't use that feature of your 1091 with unmodified AppleWorks. This rankled me, so I worked out a patch to the AppleWorks Epson FX control codes to make them work with the 1091. This patch lets you add an Epson FX to the AppleWorks printer list, then achieve proportional print on your 1091.

To make the patch, install a copy of your AppleWorks program disk in one drive. Type BLOAD SEG.PR, A\$2000,TSYS to load the configuration file. Enter the Monitor and make the changes detailed in Table 2. Type BSAVE SEG.PR,A\$2000,L\$E56,TSYS to save the patched file.

Table 3. Code locations for AppleWorks-menu printers.

Printer	Location
Apple DMP, ImageWriter	\$2446
Apple Scribe	\$2542
Apple, Sprint 11 daisy	\$25F1
Qume, Sprint 5 daisy	\$27B5
Epson FX	\$28CD
Epson MX	\$29AA
Epson MX with Graftrax	\$2A4A
Epson RX	\$2B02
custom printer	\$2BCA

The margin computations for proportional printouts are all messed up when you use the patched Epson FX codes with a 1091. Through experimentation, I worked out the following method of setting margins. Where DLS equals desired left margin and DRM equals desired right margin, set RM to zero, LM to (DLM x 2.2) - .5, and PW to DLM - DRM + 10.3. This is clearly a nuisance, but the proportional print looks great.

Other readers may want to examine the canned AppleWorks printer codes to see why they've been getting un-

expected results in their printouts. I've located the control code for the other AppleWorks-menu printers. It's stored sequentially as strings of code preceded by their lengths. For example, \$02 \$1B \$4D is the 2-byte control string \$1B \$4D (ESCAPE-M). Table 3 shows the code locations when SEG.PR is BLOADED to \$2000. Note that models with proportional-print capability (the first five) precede those without (the last four).

There's no control-code table for Apple Silentype features, since the Silentype has no features AppleWorks uses. This provides a quick solution for someone who wants a uniform character-pitch printout with an unsupported printer: Just add the printer to the list as a Silentype. No control codes will be sent, so all features of the printer will be left as is, and no garbage will be printed at the left margin. ■

Product Information

Computerfacts

Howard W. Sams & Co.
P.O. Box 7099
Indianapolis, IN 46206
(800) 428-SAMS
\$19.95 each

Reader Service Number 349

WILL YOUR PROGRAMS BE READY WHEN YOU ARE?

The **quikLoader™** provides *absolute* security of programs. The program can be put onto an EPROM chip, plugged into the quikLoader, and the quikLoader plugged into any slot of the APPLE™][,][+, or //e. The program cannot be changed from the keyboard.

Any program that can be loaded as files can be stored on the quikLoader with the aid of an EPROM programmer board (such as the PROMGRAMER™), and our new PROGRAMMERS AID program. Up to 512K of programs can be stored on each quikLoader. Access to these programs can be as easy as turning on the computer.

An example of practical business applications is APPLEWORKS™. We can copy your copy of APPLEWORKS for an additional \$89.50, and the program will be up and running within 2 seconds after turning on the computer. There is no need to use either the startup or program disks.

This is ideal for work stations with only one drive. Production is increased, since no time is wasted loading the program, swapping disks, or changing modules as you go along.

The quikLoader provides many other benefits. As soon as power is applied, DOS loads automatically from the card. Included with the quikloader are the popular programs FID and COPYA.

Installation is easy, just plug it into any peripheral slot. Installed programs can be called up by a keypress, or through a special catalog routine.

SYSTEM REQUIREMENTS - The quikLoader will work in an APPLE][,][+, or //e. If used in a][or][+, a slightly modified 16K memory card is highly recommended in slot 0. A disk drive is required to save data.

\$179.50

APPLEWORKS and APPLE //e are trademarks of APPLE COMPUTER INC. quikLoader (designed by Jim Sather) is a trademark of S.C.R.G. DOS 3.3, Integer BASIC, FID, and COPYA are copyrighted programs of APPLE COMPUTER, INC. licensed to Southern California Research Group to distribute for use only in combination with quikLoader.

OTHER PRODUCTS

WRITE GUARD

Designed by Mark Hansen

Use both sides of diskettes without cutting holes. Write protect any diskettes without tabs. Write enable diskettes for update without removing tab. LED to verify write protect status without removing diskette. Easy installation, no cutting or soldering. For use only on APPLE™ DISK][.

\$45.50

DUAL KEYBOARD ADAPTER FOR APPLE][AND][+ ONLY

Allows the use of a second keyboard without disabling the main keyboard. Use either one with no switching necessary. No soldering is needed, and installation is as easy as plugging in the second keyboard.

\$39.50

//c KEYPAD kit

This kit gives you an "embedded" keypad within your built-in keyboard. You may instantly switch between the keypad or the standard keyboard. CAUTION - Requires expert soldering ability, and disassembly of the computer. Estimated installation time - about one hour. Comes with step-by-step instructions, new keyboard PROM, solder, socket, and a set of decals for the keycaps.

\$29.95

PROMGRAMER™

Designed by Bob Brice-Software by Bob Sander-Cederlof

The PROMGRAMER is an inexpensive EPROM (Erasable Programmable Read Only Memory) programmer for the APPLE][,][+, and //e computers. The unit plugs into any slot of the computer, and allows the user to program any standard 5 volt, 27 series EPROM. The ZIF (zero-insertion force) socket allows rapid programming, copying, duplication, or modification of EPROMs.

\$149.50

SLOT 3 CLOCK™

Designed by Chuck Shaffer

The SLOT 3 CLOCK is designed to work in the APPLE][,][+, or //e. Unlike other clocks, it can plug into slot 3 of the //e without interfering with the operation of the auxiliary memory card. PRODOS™ is fully supported, and the card is APPLESOFT™ compatible. Installation software and a long-life DURACELL™ lithium battery are included.

\$79.50

BOOKS BY JIM SATHER

Understanding the APPLE][- The definitive source of information about how the APPLE][works. Forward by Steve Wozniak. **\$22.95**

Understanding the APPLE //e - The companion volume to "Understanding the APPLE][". Covers the additional information needed to know details of the hardware of the computer. **\$24.95**

"Understanding the Apple //e leaves no stone unturned in the search into the inner workings of the Apple //e computer" - Steve Wozniak

SWITCH-A-SLOT

Designed by Joy George

The SWITCH-A-SLOT is an expansion chassis, which allows the user to plug in up to four peripheral cards in one slot. One of these cards is selected for use, and *only* that card draws power.

This product is especially useful where the software requires the printer to be in a particular slot, and the user wishes to choose between two or more printers. **\$179.50**

SWITCH-A-SLOT and EXTEND-A-SLOT work well with most slow to medium speed cards, such as modems, printers, clock, music, etc. They are not recommended for high speed data transfer devices such as disk drive controllers, alternate processor, and memory cards. Due to the nature of these products, and unit-to-unit variations of computers and peripherals, we are unable to guarantee that these products will work with any particular system. However, as with all our products, we offer a ten-day trial period. If our product does not operate to your satisfaction, return it for a prompt refund.

EXTEND-A-SLOT

The EXTEND-A-SLOT brings a slot outside your APPLE™, allowing an easy change of cards. The 18" (45cm) cable is long enough to allow placement of the card in a convenient location. The high quality connectors are gold plated for reliability. **\$34.95**

Paddle-Adapple

The PADDLE-ADAPPLE is a game plug expansion adapter that plugs into the interior game I/O socket, and is designed to operate in one of two modes. In the first, it allows you select between one of two devices, such as Koala Pad™ and joystick. The device is selected by the flip of a switch. In the second mode, the PADDLE-ADAPPLE, with appropriate software, allows the use of two joysticks simultaneously.

There are three versions to adapt to any combination of the newer type APPLE connector (the 9-pin D sub-miniature), or the older 16-pin plug.

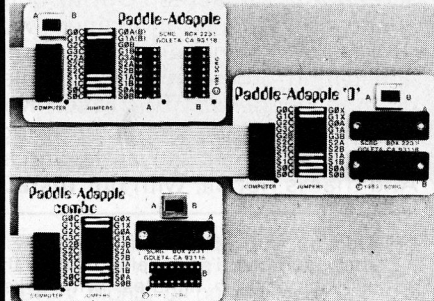

- The PADDLE-ADAPPLE has two 16-pin sockets.
- The PADDLE-ADAPPLE 'D' has two subminiature 'D' (9-pin) connectors.
- The PADDLE-ADAPPLE COMBO has one 'D' subminiature and one 16-pin connector.

\$29.95

9-16 Adapter for APPLE //e & //c

The 9-16 adapter permits the use of most 16-pin I/O devices with the APPLE //e or //c. Plugging this adapter into the subminiature 'D' connector allows the use of 16-pin device, such as the PADDLE-ADAPPLE, paddles, joystick, 16 pin Koala Pad™, etc. The only limitations are those devices that use the annunciators or the \$C040 strobe. NOTE - the //c does not support the simultaneous use of two joysticks. **\$14.95**

16-9 Adapter for APPLE][and][+

With this adapter, owners of early APPLES can take advantage of the newer 9-pin game products, such as paddles, joysticks, MUPPET LEARNING KEYS™, etc. NOTE - If you have more than one game I/O device, consider purchasing our PADDLE-ADAPPLE COMBO or PADDLE-ADAPPLE 'D' instead. **\$14.95**

TEN DAY TRIAL - SIX MONTH WARRANTY TOLL FREE ORDER LINES

From California (800) 821-0774
Rest of U.S. (800) 635-8310

Outside of U.S. or for

information, call (805) 529-2082

U.S. and Canada shipping charges - all items, \$2.50
Other countries: SWITCH-A-SLOT: \$10 surface, \$25 air.
Other items: \$5 surface, \$10 air.

SOUTHERN CALIFORNIA RESEARCH GROUP

Post Office Box 593-R

Moorpark, CA 93020

Telephone (805) 529-2082

Telex 658340-SCRG (Intertel SNC)

VISA - MASTERCARD ACCEPTED

This man has the *EasyCard*...

and this man does not.
Obviously...



EasyCard... it makes your life easier.

Featuring 6 Systems in One

★ SideJob ★ MacroKey ★ InstaDOS ★ Screen Dumps ★ Copy Program ★ Clock

EasyCard is a peripheral card for Apple II+ and IIe that allows you to suspend execution of any application program. At that point you can run any of the *EasyCard* software systems; you can organize your desk with the **SideJob**, print the content of the screen with the **Screen Dump** or make a copy of the application program in memory with the **Copy Program**. And when you are done, return back to your application program with a single keystroke, as if nothing happened. The **MacroKey** system allows you to assign long character strings to a single key and play these back any time with a single keystroke. And that is not all; with our **InstaDOS** system you

can load DOS 3.3 or ProDOS without ever reaching for a diskette. On board **Clock** is of course DOS/ProDOS compatible.

All of the *EasyCard* software systems are resident in the card; so there are no diskettes to load. Future additions to the *EasyCard* software family will be available on simple to install EPROM's. Unlike the so called "enhancers" the *EasyCard* does not steal any Apple's memory from your application programs. **The *EasyCard* hardware and software is compatible with all 6502/65C02 application programs. Absolutely no modification is needed for your software.**

- ★ **SideJob** is to Apple what SideKick is to IBM PC. Modeled after the Borland's top seller of 1985 the SideJob will clean-up your desk in minutes. With a keystroke get into the SideJob window where you can run a Calculator with numerical and logical functions, jot down notes on a Note Pad, glance at the ASCII Table or do decimal-hex-binary conversions. When you are done, single keystroke gets you back to your application program as if nothing happened.
- ★ **MacroKey** is a perfect solution to repetitive typing of lengthy character strings. Just assign strings of characters to keys of your choice and everytime you press these again while holding *EasyCard*'s secret key the strings will be typed in automatically. To all application programs this will appear as if typed by you. Now that's artificial intelligence working for you!
- ★ **InstaDOS** is like having DOS 3.3 or ProDOS built directly into your Apple. Now you can store each of these utilities in the *EasyCard* memory and download them without ever using the diskettes again. What a time saver!

- ★ **Screen Dump** will give you a hard copy of what is on the screen. Exactly as you see it and any time you want it! Prints text, HI and DOUBLE HI RES graphics or mixed displays at a push of a button. Can even blow-up graphics to twice the size! Compatible with most popular printers and interface cards. Unlike other screen dump software or cards this system works also on protected programs.
- ★ **Copy Program** is an extensive utility software package. It allows you to make backup copies of all (including protected!) memory resident programs of up to 128k at a push of a button. Copying time is less than 30 seconds. The copy produced is unprotected and subject to study or change. Special software included allows the copy to run without the *EasyCard* in the Apple. Other functions can be used to single step and trace through any program.
- ★ **Clock** is of course ProDOS compatible. But now you can also check the time/date while in the middle of any application program. That is something no other clock can do!

Pricing Information: *EasyCard* board without any software: \$119.99; for each software system add \$29.99. Buy packaged sets and save: Starter Set with the board, the Copy Program, Screen Dumps and SideJob: \$159.96 (save \$50); Advanced Set with all six systems: \$219.93 (save \$80). Add \$5.00 for shipping and handling. Calif. residents please add 6% (L.A. County 6.5%) Calif. Sales Tax. Please specify computer, printer and interface card when ordering.

ATL's *EasyCard* . . .



don't use your Apple without it!

APPLIED TECHNOLOGY LABORATORIES 11926 Santa Monica Boulevard, Los Angeles, California 90025 (213) 477-6815

Trademarks: Apple II+ and Apple IIe are trademarks of Apple Computer, Inc. IBM PC is a trademark of International Business Machines Corp. SideKick is a trademark of Borland International, Inc.

Circle 243 on Reader Service Card.

REVIEWS

Managing Your Money, ProModem 300c, Let's Talk, Viewtron, GENie, BetterWorking Word Processor with Spellchecker, Echo Plus

Cash Cruncher

MANAGING YOUR MONEY

MECA, 285 Riverside Avenue, Westport, CT 06880

Home-finance software; Apple IIc or 128K IIe, two drives
\$199.95

- Ease of setup ■■■■
- Ease of use ■■■■■
- Documentation ■■■■
- Support ■■■■
- Overall ■■■■

The best thing about Managing Your Money, MECA's home-finance tracking system, is that any of these programs automatically sends data to each of the others. When you write a check for health insurance, for example, the package subtracts the amount from your checkbook, tags it as deductible from your income tax, enters it into your budget in the right place, and even deducts it from your net worth.

Managing Your Money prints checks (an easy process) and lets you type in information from handwritten checks, cash transactions, credit-card charges, payments, interest, and so on.

Through all phases of the program, you control the amount of detail with which you want to work. If you want to lump all your travel expenses into one category, that's fine. If you want to separate business and personal travel, that's also fine. In addition, you can itemize your trips by airline, month, type (including deductible or not), or any other feature.

Getting Started

The manual accompanying Managing Your Money is 110 pages long, but you can skim through it and use the program without much further reference. The program is filled with help screens you can call up with the escape key. All screens sport a window format—one for instructions and one for data entry.

Managing Your Money checks your system each time you start it. If you've installed an Apple II Memory Expansion card, you have, in effect, a



RAM disk. The program takes advantage of this by letting you work with detailed "what-if" scenarios that don't affect your real data.

The program also supports the new Apple UniDisk 3.5. The entire package fits on a single disk, and works with either one microfloppy-disk drive and a standard 5¼-inch drive, or two microflopies.

The first time you use Managing Your Money, it leads you through an easy set-up procedure, taking into account the right number and type of data disks you'll need. The program comes on three double-sided, non-copy-protected floppies. Sample data on disk help you get the feel of the program, but they're easy to remove from your files when you're ready to type in your own information.

The program includes a memo pad to note upcoming events (mortgage payment due or Aunt Millie's birthday) and an automatic reminder to jog

your memory a few days in advance. These memos can be repeating (every month or once a year, for instance), or just one-time reminders.

Basics and Extras

The heart of Managing Your Money is the budget and checkbook section, in which you list in detail what you expect to collect and spend, then record what actually happens to the cash you take in and send out. You always know where you stand financially.

As with any recordkeeping system, the key to Managing Your Money is that you actually have to sit down and put the figures into your Apple.

inCider's Ratings

- Excellent ■■■■■
- Above average ■■■■
- Good enough ■■■
- Not up to standards ■■
- The empty set ■

This program makes the whole process easy—even fun sometimes. (Error messages, for example, are gentle reminders that give you a chuckle as you correct your mistakes.)

The package includes a tax estimator that gives you a pretty close idea of what you'll owe for federal and state income taxes, based on what you earned and the types of deductions you can take. It's very easy to update the program's tax tables whenever Congress and the IRS fiddle with the tax laws.

There's a section on insurance that gives advice (which you may or may not like) on which types to buy and where to buy them. You type in your age and other facts about your life, and the program will tell you your life expectancy. It asks questions about your lifestyle, the number of children you have, and so on, then calculates the amount of life insurance you need (the answer will startle you). It also records and organizes your policies.

Managing Your Money includes a financial calculator that's definitely unlike the one on your desk. It lets you talk to your computer in nonfinancial terms, simply by filling in blanks on your screen. This part of the program also includes powerful analysis worksheets that help you evaluate real-estate investments, tax shelters, and so on.

The same philosophy carries over into the portfolio manager, which is much more than a place to record the shares of stock you own. It helps you decide what you should do—if anything—with your investments by examining your tax situation under different conditions, even to the point of tracking hypothetical portfolios.

All of this comes together in one place, when Managing Your Money calculates your net worth. As with most parts of this package, you can ask for as much detail as you want. If you want to list household furnishings that total \$5000, that's what the program will do. On the other hand, if you want to record the value of your

TV set, the cost of your stereo, how much cash you've invested in computer hardware and software, or whatever, the package will track each detail for you. If you do go to the trouble of providing the program with a complete household record, it gives you a terrific list for insurance purposes.

At the end of each year, the system automatically creates disks for your archival data, and formats new data disks for the upcoming period.

All sections of Managing Your Money let you store your data and analyze your financial information. And while you may not have an IRA account, stocks, rental property, or tax-deferred bonds right now, the program contains information about these matters for a time when you may need it. You'll never outgrow this program.

I Wish. . .

Managing Your Money would be improved if it let you use a slot besides slot 1 for your printer. If you ask to print when the printer isn't connected or turned on, the program just stops without letting you know the nature of the problem.

While the manual should get extra credit for its simplicity, it isn't perfect. For instance, in the Net Worth chapter, one menu selection lets you "delete all non-extract items below Assets and Liabilities." When you choose this option, you get an on-screen warning: "Please verify your decision to purge Net Worth. Only Net Worth, Assets, Liabilities, and Extractable items will remain."

I didn't understand that when I first read it. Neither "extract" nor "extractible" nor "purge" is in the manual's glossary. Fortunately, pressing the escape key brings up help screens that clarify these items, but the details should be described in the manual, too.

I'd also like to see graphs to examine financial data. Too often, all those numbers are hard to understand. A picture of your figures tells you exactly what's happening.

The Bottom Line

Managing Your Money has been touted as a reason to own a personal computer. Is it that good? A certain amount of effort is required to type in your data, and you must maintain it on a regular basis. (If you forget where you spent some of your cash, the results will be meaningless.) But if you're willing to invest some time in your own financial interest, Managing Your Money can pay for your com-

COPY II PLUS™

THE BEST, MOST COMPLETE ProDOS-DOS UTILITIES.

- Copy files, disks, even entire subdirectories.
- Undelete ProDOS and DOS files.
- Fast 2-pass disk copy on Apple IIe, IIc or Laser 128.
- Tree display for selecting subdirectories—no need to type lengthy "prefixes."
- Alphabetize catalog.
- Convert DOS to ProDOS & vice versa.
- And many more.

BACKUP YOUR PROTECTED SOFTWARE.

With COPY II PLUS' fully automatic bit copier, simply type in the name of the program you want to backup and COPY II PLUS does the rest. (We update COPY II PLUS often to handle new protections; you as a registered owner may update at any time for \$15 plus \$3 s/h.)

Parameters for hundreds of programs are right on disk. Also includes a track editor, sector editor and HI-RES disk display. COPY II PLUS is supplied on a standard ProDOS diskette. Runs on Apple II, II+, IIe, IIc and Laser 128. Requires at least 64K and one or two disk drives.

Call 503/244-5782, M-F, 8-5:30 (West Coast time) with your  in hand. Or send a check for \$39.95 U.S. plus \$3 s/h, \$8 overseas.

\$39.95

Central Point Software, Inc.
9700 S.W. Capitol Hwy., #100
Portland, OR 97219

Central Point Software
INCORPORATED

Backup utilities are also available for the IBM, Macintosh and Commodore 64/128.

What the Experts are Saying About RamWorks II!®

"In an informal competition called '640K vs. 640K' AppleWorks running on a RamWorks equipped Apple IIe outperformed Symphony running on an IBM PC."

—*InfoWorld*

"AppleWorks wiped out Symphony. . . The competition was set up partly to show off another of Wozniak's favorite things, the RamWorks II memory expansion board from Applied Engineering . . ."

—*San Jose Business Journal*

"There are huge differences among the AppleWorks modifying programs sold with the cards. Without doubt, RamWorks II is the most powerful."

—*inCider*

"Applied Engineering's RamWorks is a boon to those who must use large files with AppleWorks. . . I like the product so much that I am buying one for my own system."

—*A+ Magazine*

"RamWorks II is the most powerful auxiliary slot memory card available for your IIe, and I rate it four stars. . . For my money, Applied Engineering's RamWorks II is king of the hill."

—*inCider*



As you can see, it's easy to tell who sets the pace in Apple memory expansion. In fact, if you read the competition's ads, you'll notice that many even claim to be as good as RamWorks. Some say they're "RamWorks compatible". At least they agree on one thing. RamWorks is the one they have to measure up to. But the truth is there aren't any substitutes for RamWorks. Because RamWorks and Z-RAM have a mesmerizing list of characteristics that, as you use them, will change your perceptions of an Apple computer forever. Achieving a level of speed and performance most critics claim is the best they've ever seen. But we want to do more than impress the experts, we want to impress you!

Applied Engineering stands ready to solve your expansion needs today and tomorrow with the largest and best supported product line in the industry.

Call Applied Engineering at 214-241-6060, 9 am to 11 pm. To get the very best.

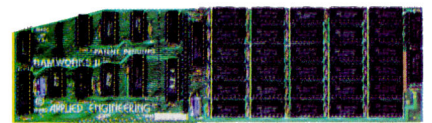

RamWorks II®

The recognized industry standard for memory expansion in the Apple IIe.



214-241-6060

YOUR
APPLE
TODAY,
KEEPS THE
DOCTOR
AWAY.

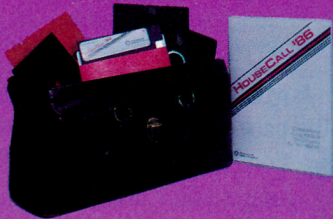

HOUSECALL

THE COMPUTERIZED
HOME MEDICAL ADVISOR

- Written By Physicians.
- Over 400 Diagnoses.
- Concise Information accessed directly or through branching questionnaire.
- Educational—background and treatment for each condition diagnosed.
- Closely Related Diagnoses follow computer's initial choice.
- A Ready "Second Opinion".
- Fast, Easy and Fun to use.
- Self Contained—Multiple disk data base—no modem needed.
- Always Current—yearly updates available at nominal cost.

Great For Business Offices As An Employee Benefit. Also Helps Reduce Absenteeism

HOUSECALL Will Run On APPLE II +, c, e, IBM PC Family, and 100% Compatibles. Dealer inquiries invited.



**Rocky Mountain
Medical Software, Inc.**

To Order Call Toll Free
(800) 233-3556
For More Information Call
(303) 773-1237

List Price \$79.95 **SPECIAL \$49.95**

Please send _____ copies of **HOUSECALL**
@ \$49.95 + \$5.00 shipping (\$12.00 foreign).
(Colorado residents add \$1.80 tax). 20 Day Money
Back Guarantee. For Unprotected Add \$20.00.

Type of Computer _____

Name _____

Address _____

City/State/Zip _____

Check VISA MC Exp. Date _____

No. _____

Signature _____



**Rocky Mountain
Medical Software, Inc.**

5680 S. Syracuse Circle, Suite 500 I
Greenwood Village, CO 80111

REVIEWS

puter the first year you use it, just by letting you experiment with the system's "what-if" capabilities. ■

Gregory Glau
Prescott, AZ

Editor's note: Nancy Lepper of MECA reports that the company is in the process of sending updated program disks free of charge to all registered owners of Managing Your Money. The printer problem has been remedied, and the new version also sports increased speed and RamWorks compatibility.

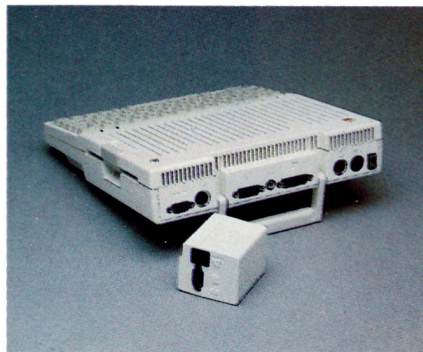

The Easy Connection

PROMODEM 300C

Prometheus Products, 4545 Cushing
Parkway, Fremont, CA 94538

Direct-connect external modem; Apple //c
\$119

Ease of learning	■ ■
Ease of use	■ ■ ■
Documentation	■ ■
Support	■ ■ ■
Overall	■ ■ ■ ■

If you've been putting off buying a modem for your Apple //c, wait no longer. The ProModem 300c is styled specifically for the //c, offers practically every feature you could ask for, and carries a remarkably low price tag.

Simple and Portable

When you open the package, you find the smartly designed ProModem 300c itself, two floppy disks with the copyable ProCom-A communications software, and a spiral-bound *Installation and Instruction* manual.

The ProModem 300c is cube-shaped, color-matched to the //c, and about 3 inches on each side. It connects directly to the modem and game-controller ports near the right

rear corner of the Apple //c.

What happens if you want to play a game? No problem. The ProModem 300c includes a game-controller port, thereby "moving" it to the right side of the //c (see the accompanying photo), so attaching a joystick or mouse is easier than ever. Above this "transported" port is the RJ-11 port for connecting your telephone.

I installed the ProModem 300c in a matter of minutes—seconds, actually—even without reading the manual. Like the //c itself, the ProModem 300c is inserted directly into a jack via a phone cord, so if you want to use it without unplugging the phone, you have to purchase a T-adaptor from your local electronics or hardware store.

Unlike the Apple Personal Modem and other modems, the ProModem 300c draws its power from the //c, and therefore requires no separate power source, and no power cord to clutter up your workspace. The modem's compact shape, method of attachment, and low-power CMOS circuitry make the ProModem 300c perhaps the only transportable modem for the //c.

Like many higher-priced modems, the ProModem can automatically dial The Source, Dow Jones, or your buddy's computer on the other side of town. If you want to receive an important message when you're not home, your ProModem 300c can answer the phone for you. Because human callers will hear a deafening, high-pitched tone when your modem picks up the phone, it's best to have a phone line specifically for your computer in this situation.

The ProModem 300c has a built-in speaker, so you can hear the dialing process. It distinguishes between touch-tone and pulse phone lines, and automatically adjusts itself accordingly. What if the phone on the other end is busy? Just relax while the ProModem redials the number as often as you like.

Software Operation

The ProModem 300c is Hayes-compatible, an attribute that has become an important standard for communications products. You can boot up your favorite Hayes-compatible software and use the standard Hayes commands. Or, even better, you can try ProCom-A and let your fingers do the walking.

ProCom-A gives you a built-in electronic telephone directory in which

"Pinpoint makes AppleWorks™ better than my Macintosh."

It gives me the flexibility of Mac-like desk accessories and the ability to add the features AppleWorks 'forgot'™

*Michael Fischer, Columnist, Bay Area Computer Currents.
Author, 65816 Assembly Language Programming, 1986, Osborne McGraw-Hill.*

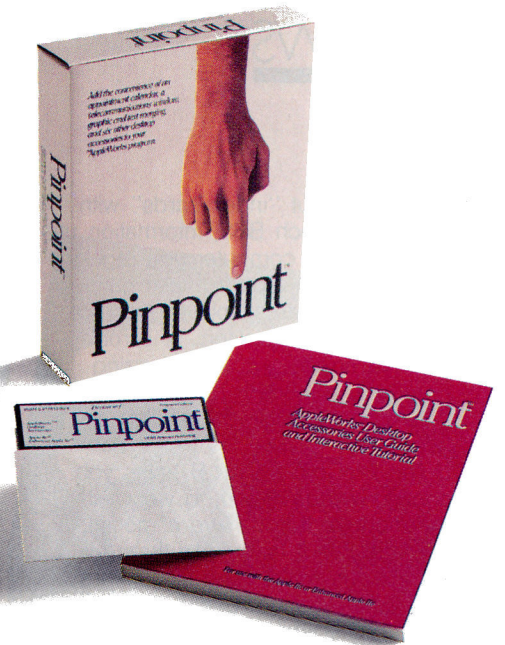

PINPOINT™ DESKTOP ACCESSORIES Now you can address an envelope, call a friend, schedule an appointment, search online databases, send or receive electronic mail, merge pictures and text, jot down notes, calculate numbers, or pop-up an electronic typewriter. Without missing a beat. Or a byte. These handy desktop timesavers "pop-up" via windows from inside AppleWorks and other selected ProDOS™ programs. Eight powerful applications in one high-performance package. **\$69.**

YES, I WANT TO GIVE MY APPLE II THE WORKS.

Order both Pinpoint and Spelling Checker NOW! We'll supercharge your RAM card with the \$29 RAM Enhancement Kit FREE! **\$125** ▶

- \$69 PINPOINT Desktop Accessories.
- \$69 Spelling Checker. Requires Pinpoint.

Pinpoint's software requires an Enhanced Apple IIe with 128K, or Apple IIc. We recommend two floppy disk drives, a UniDisk 3.5, hard disk, or RAM drive.

Name _____
 Address _____
 City _____
 State/Zip _____
 Telephone _____
 Payment: VISA MC Check
 Credit Card # _____
 Credit Card Expir. Date _____
 Add \$3.00 shipping. CA residents add 6.5% sales tax.

Box 13323, Oakland, CA 94661, (415) 654-3050

Pinpoint

National 800-227-6703
 California 800-632-7979

Break the 128K barrier. For top performance use Pinpoint Accessories with your RAM card from Apple, Applied Engineering, AST or Checkmate. The RAM Enhancement Kit lets you do even more.

SPELLING CHECKER Pop it up and quickly check individual words, paragraphs, or entire documents without leaving AppleWorks behind. Poof! Check for misspellings from a 55,000 word dictionary and an unlimited personal dictionary. It suggests up to 10 alternative spellings, corrects words in place, and reformats as it corrects. You can even edit words it finds yourself. Absolutely the quickest most convenient way to produce letter-perfect documents. **\$69.**

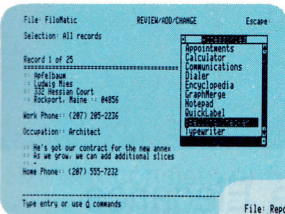

Up to 16 Accessories. Add new accessories anytime. Like the SPELLING CHECKER, or the powerful INFORMATION ENGINE™ for desktop reference publishing on floppy disks or CD-ROM — encyclopedias, user guides, directories and courseware.

Find misspellings, suggest, correct, edit, and reformat. Instantly check any word, paragraph or document, spreadsheet or database entry. Even edit your work on the fly!

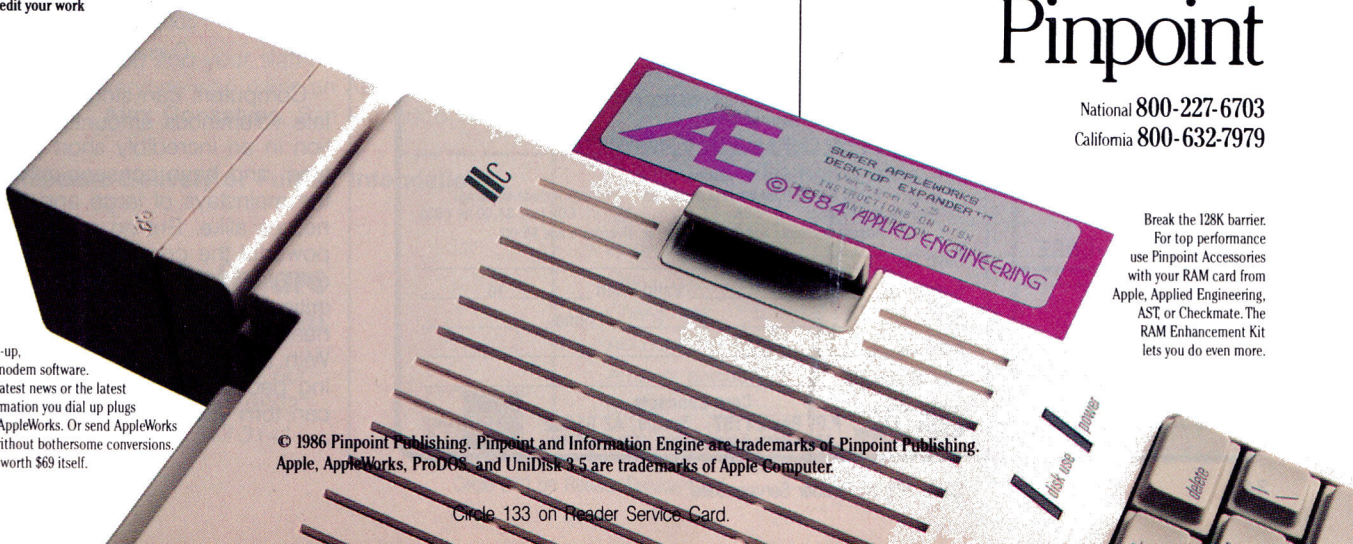
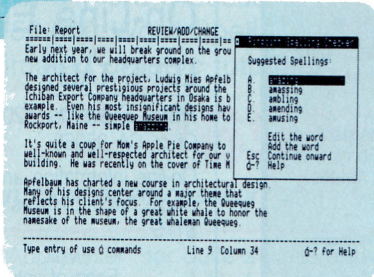

Includes pop-up, auto log on modem software. Capture the latest news or the latest recipes; information you dial up plugs directly into AppleWorks. Or send AppleWorks documents without bothersome conversions. Convenience worth \$69 itself.

© 1986 Pinpoint Publishing. Pinpoint and Information Engine are trademarks of Pinpoint Publishing. Apple, AppleWorks, ProDOS, and UniDisk 3.5 are trademarks of Apple Computer.

Circle 133 on Reader Service Card.

you can fill out "index cards" with data about each BBS, information utility, or friend's computer you regularly call. Once you type in these notes, logging on is as simple as moving the mouse and clicking, or scrolling with the arrow keys and pressing Return. The modem takes over and automatically dials—and redials if necessary.

The ProCom-A Disk B helps you configure your system to work with the modem. If you have a mouse, you can use it to browse through menus and make selections with a click of the button. Each submenu looks like a tabbed index card on screen. To move back to the previous menu, simply press the escape key.

Using ProCom-A for sending electronic mail is a snap. You can use the built-in word processor or your favorite ProDOS word processor. Once your file is in memory (ProCom-A recognizes Apple's UniDisk 3.5 as a storage drive), you direct the modem to dial a BBS or your editor and send the document.

You can upload (transmit) a file in a couple of different ways. You can use Xmodem protocol, which sends one block of data at a time, and checks to see that each was received intact. Or you can send a file without error checking.

Downloading (receiving a file) is even easier than uploading. You can view incoming data on screen—for instance, when you're browsing on CompuServe or trying your hand at your local BBS trivia quiz. You can direct incoming data to the ProCom-A word processor, your disk drive, or printer. These options can save you money because they reduce the amount of connect time—not to mention AT&T time—you're on line.

Though the ProModem 300c and ProCom-A software are quality products, the Prometheus documentation leaves a lot to be desired. The print size is so tiny you tend to avoid reading the manual. When you do, you won't find any index. And the message on page A-4, "put Figure 4-1 from 1200A manual here," tells us

that some "error checking" is needed.

The ProModem 300c with ProCom-A software is reasonably priced compared to other modems, including the Apple Personal Modem (300/1200-baud, \$399). It may be the modem of choice for users needing a transportable, Hayes-compatible, full-featured modem with advanced communications software. ■

Cynthia E. Field
Wakefield, RI

Editor's note: Tom McShane of Prometheus Products apologizes for the difficulty readers are having with the ProModem 300c manual: "We'll set the next version in a larger type size."

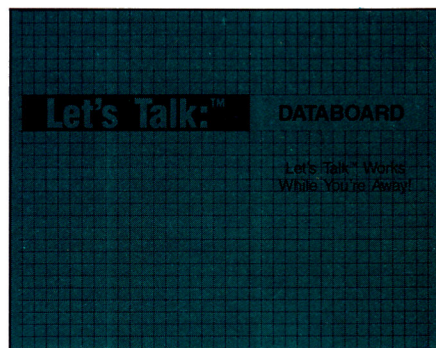

On-Line Elegance

LET'S TALK

Russ Systems, 320 Dufour Street, Santa Cruz, CA 95060

On-line information and messaging system; Apple IIe, IIc, Hayes Smartmodem-compatible \$175

Ease of setup	■ ■ ■ ■ ■
Ease of use	■ ■ ■ ■ ■
Documentation	■ ■
Support	■ ■ ■ ■ ■
Overall	■ ■ ■ ■ ■

Computers can store and manipulate voluminous amounts of information in an incredibly short period of time, and have consequently become the mainstays of large and small businesses alike. But no matter how powerful the computer, its ultimate usefulness depends on how quickly critical information can get into the hands of the people who need it. With Let's Talk, an automatic-messaging package from Russ Systems, you can turn your Apple into a sophisti-

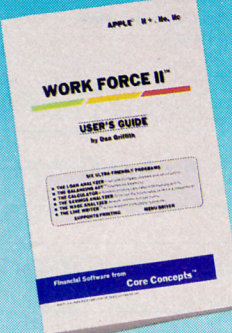

WORK FORCE II™

"A Valuable, Indispensable Tool..."

Business Section, The San Francisco Independent

Six Financial & Productivity Programs on one disk. Menu driven, ultra friendly, powerful. Compatible with the IBM PC, XT, AT, jr, true Compatibles, and the Apple IIc, IIe, II+, II.

THE LOAN ANALYZER™: Display or print loan amortizations starting or stopping at any period. Begin loans in mid-year. Work Force II is used by banks, CPA's, and real estate professionals across America. Work Force II will find:

- Balloon Payments
- Yearly Total Interest
- Unknown term
- Payment Amount
- Negative Amortization
- Total Interest & Payments
- Amount which can be Financed
- Present Value of Capital Leases

THE LINE WRITER™: Line-at-a-time correctable typewriter. Makes envelopes, forms, memos, and labels a snap. Faster and easier to use than your word processor.

THE BALANCING ACT™: Unique checkbook balancing system. No need to enter every check & deposit. Change entries, add entries, or print entries. A few minutes each month does it all.

Full Function Printing Calculator — Wage & Income Analysis
Future Value of Savings, Investments, IRA's

Greg Glau, inCider "Borrowing money is no problem with the loan analysis section to guide you. Work Force II is easy to understand and operate. It's an honest value..."

Les Schmeltz, MICRO-TIMES: "WORK FORCE II may be one of the best bargains around."

Call Toll Free

ORDERS ONLY

1-800-525-CORE

30 DAY

MONEY-BACK

GUARANTEE

Rush me WORK FORCE II for the Apple at \$39.95
 Rush me WORK FORCE II for the IBM at \$47.95 (prices include shipping)
 check or money order VISA MC AE COD (add \$4.00 for COD)
Arizona residents add 6.5% Sales Tax. Overseas add \$5.00

Card # _____

Signature _____ Valid From _____ to _____



Name _____ Phone _____

Address _____

City/State/Zip _____

Core Concepts

P.O. Box 24157 Tempe, AZ 85282
AZ residents & inquiries call (602) 968-3756

Mad as HELL at your Apple IIe/c Word Processor-Speller?



You don't have to take it anymore!

Writing Software International solves your frustrations with other Apple IIe/c Word Processor and Spell Checking systems.

Our Bard's "Pro-Am" Apple IIe/c Writing System consists of 3 Word Processing levels, a built-in 50,000 Word Spell Checker and includes animated graphic tutorials.

All for the tranquilizing price of only \$6995

(This is less than most spell checkers alone!)

"I struggled with "Applewriter" for quite a while and was continually frustrated by my inability to make it work. I was able to go immediately to your "Professional" program and use it without frustration. I am completely satisfied." **Sheila Stern**, Baldwin, N.Y.

"I congratulate you and your staff for a marvelous program that everyone who owns an Apple (IIe/c) ought to use." **Alex Gonsalves**, San Francisco

**For Immediate Delivery or Further Information
Call Toll FREE 1-800-348-2729 (Ext. 1019)**

**Writing Software
International**

110 E. Broadway • Suite 600
Missoula, Montana 59802
(406) 543-3141



What makes the Bard different?

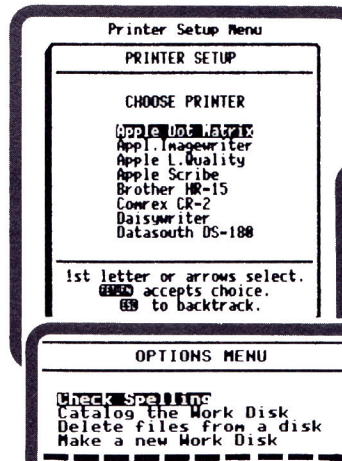

Over 30 popular pre-programmed setups. Select printer, then typeset font features with menu choices.

Preview full pages for layout problems before printing!

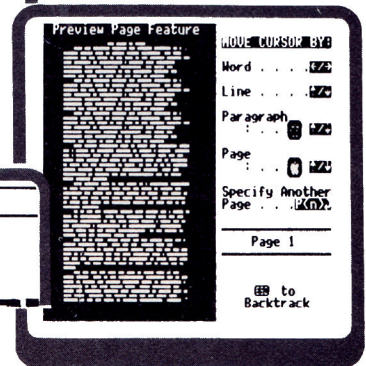

50,000 Word Spell Checking without multiple disk swaps. Add your own words, too!

Also, 40/80* column versions, Macros, Cut/Paste, Find/Replace. Illustrated manual.
* Extended 80 column card required. Professional level requires 2 drives.

Writing Software Int. • 110 E. Broadway • Suite 600 • Missoula, MT 59802

Please send me the Bard's "Pro-Am" Apple IIe/c Writing System for \$69.95
(Add \$3.50 for postage and handling.)

Name _____
Address _____
City _____ State _____ Zip _____
Charge my Visa MasterCard American Express
Account # _____ Exp. Date ____/____/____
Amount enclosed \$ _____ Telephone _____
Signature _____

THIRTY DAY MONEY BACK GUARANTEE!

cated information-exchange system to help you stay a step ahead of the competition.

Let's Talk lets you set up an inexpensive, customized on-line information service—something akin to a personalized CompuServe. Let's Talk comes on two disks—the system disk, containing the program and many helpful utilities, and the presentation disk, which you use as a framework for constructing your information service.

In This Corner. . .

The presentation disk is the heart of the Let's Talk system, since on this disk you place the menus and information that will be available to people who call your bulletin board. The presentation disk also reveals the simplicity—and elegance—of the Let's Talk system. Its on-line menus are nothing more than ProDOS directory files, while your information is contained in ASCII text files.

Setting up a logical, orderly on-line system is easy with Let's Talk. You don't get bogged down in the details of your telecommunications system. You devote your time to ensuring the quality of the information you present.

The volume directory of the presentation disk is the main menu of your on-line system. It contains four directories: Introduction, Public.Access, Private.Access, and Quit. A first-time caller can choose Introduction to get a feel for how the system works. Public.Access leads to the menus and information files you want to make available to anyone who calls the system. For example, you can list product information here for potential customers and take their orders on line. Public.Access is generally used as a gateway to nonconfidential information.

Private.Access leads to menus and files containing confidential data. For instance, you could use it to give your sales force updated information on pricing and availability, or to handle private messages. You would normally password-protect the Private.Access directory, and with Let's Talk, that's easy.

Talk Back

Besides presenting information, you can use Let's Talk to gather data—customer orders, user feedback, electronic mail, and the like. Let's Talk lets you insert prompts into your text files that direct callers to leave data on the system. You control whether the information one caller leaves will be available to others. You also control the attributes of each file in the presentation: Some files will accept input from callers, others are strictly read-only.

In addition to straight ASCII text transfers, Let's Talk supports Xmodem file transfer. Using this error-checking protocol is critical to the safe transmission of important information.

One Let's Talk utility may be worth the price of the entire package. Indenting lets you see the structure of your on-line presentation by displaying the names of all the directories and text files on the presentation disk. It shows the relationship between directories and files. This utility would be perfect for hard-disk users.

Practically Speaking

To try out Let's Talk, I set up a presentation for *inCider* authors. In

"THANKS FOR THE MEMORY"



ImageBuffer™ Makes the ImageWriter™ II Sing

Orange Micro's new ImageBuffer is the first expansion board designed for the ImageWriter II. Fitting neatly inside your printer, it provides up to 128K of buffer storage which maximizes system speed and throughput. That's up to *four times* the capacity of comparably priced buffers. And at only \$99.00 list, you can have it for a song.

What is Buffering?

Buffering saves you time. The ImageBuffer acts as a data storage tank, allowing your Apple II or Macintosh to rapidly output its print data. This enables you to quickly return to your computer, while your ImageWriter II is printing. You will never have to wait for your ImageWriter II again... even when you need multiple copies!

The ImageBuffer Advantage

The ImageBuffer is the best buffer

*Macintosh fonts are generated as graphic data.
ImageWriter II and Macintosh are trademarks of Apple Computer Inc.
© Orange Micro, Inc., 1986

value available anywhere. By snapping one into your ImageWriter II, you gain all these powerful features:

- 64K Standard Buffer
- Expandable to 128K (up to 40 pages of text!)*
- Multiple Copy Feature
- Clear Buffer Feature
- RAM Test for quick, easy troubleshooting
- No power supplies, cables or boxes
- Orange Micro's "Seldom Used" One-Year Warranty

If you already own an ImageWriter II, or are planning to purchase one, don't miss out on the ImageBuffer advantage!



1400 N. Lakeview Ave., Anaheim, CA 92807 (714) 779-2772

FREE OFFER!



A DISK EACH MONTH...

DELIVERED TO YOU AND PACKED WITH PROGRAMS FOR YOUR APPLE!

You already know how expensive software is these days and how difficult it is to choose.

We make it easy and inexpensive — a disk each month.

You deserve value. At **UPTIME** we believe in value. That's why each month 21,000 people like you enjoy a disk packed full of programs and information.

Make your life easier and get more from your computer.

Organize your life and be more productive with our **home management** and **finance** programs. Have fun learning with **educational** programs and fun relaxing with **games** and **adventures**. Monthly **tutorials** give you hands-on help with writing your own programs. You'll find business, graphics, utilities and more!

Save time and money — with at least two reviews on every disk.

Each month, we evaluate the latest hardware and software, to save you time and money shopping around and risking costly mistakes. And with our tremendous buying power, you can save on a terrific selection of hardware and software through the **UPTIME** catalog, or shop "on the disk" in our Micro Shopping Mall.

Subscribe now!

Make the very next disk yours! Fill in the coupon and return it to us, or simply call. We'll start your subscription immediately.

Take advantage of this introductory offer!

Subscribe and receive "Mail Magic" FREE! Add, edit, or delete names and addresses; sort by name, city, state or zip; print labels and more. Yours with any purchase below.

UPTIME™

THE DISK MONTHLY

For Immediate Service Call Us Toll-Free: **1-800-437-0033**
In Rhode Island: 1-401-849-4926

I'LL BYTE!!! I'm a computer enthusiast who wants more. Please start my subscription to UPTIME immediately. I want:

12 Disk Issues \$66 **6** Disk Issues \$48 **3** Disk Issues \$30 **1** Disk Issue \$11.95
(Add \$2 per issue in foreign countries, except Canada and APO)

Name _____

Address _____

City _____ State _____ Zip _____

Payment enclosed. (Please make checks payable to UPTIME.)

Bill my: VISA MASTERCARD

Account No. _____ Expiration Date _____

Signature _____

Send to: **UPTIME**, PO BOX 299, NEWPORT, RI 02840.

Subscribe now and save. You won't believe the low price! Satisfaction guaranteed.

UPTIME is the registered trademark of Viking Technologies, Inc. Apple is the registered trademark of Apple Computer, Inc. UPTIME uses DOS 3.3 and runs on Apple II+, IIe and IIc.

Circle 15 on Reader Service Card.

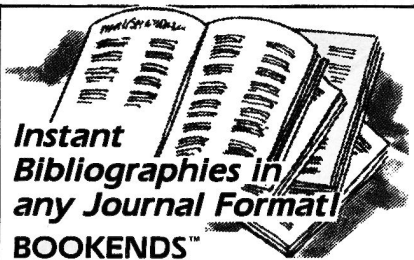

Instant Bibliographies in any Journal Format!

BOOKENDS™

allows you to quickly put your finger on any journal, any paper, any book, any specific information contained in your voluminous files.

As the *New England Journal of Medicine* states in its issue of January 12, 1984, it "addresses two widespread problems: first, the challenge of cataloging all the information we read; second... the need to convert bibliographic information into the...format demanded by each medical journal. Both problems are solved here in an excellent way."

Bookends has extraordinary versatility and edits with the ease of a word processor. There is no quicker or more efficient means of saving, retrieving and formatting reference information.

Bookends Extended is available with above features plus 80-column display, more memory, and ability to handle unlimited references.

BOOKENDS™, the reference management software system is available for Apple computers for \$124.95. Bookends Extended \$149.95.

Apple is a trademark of Apple Computer, Inc.



Sensible Software, Inc.®

210 S. Woodward, Suite 229,
Birmingham, MI 48011 (313) 258-5566

Circle 85 on Reader Service Card.

Preparing Grades is as easy as

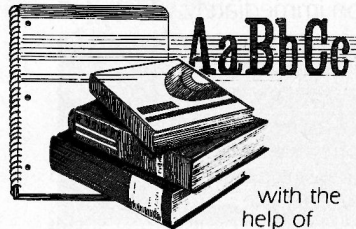

with the help of

Report Card™

the software program which saves you time and helps you avoid mistakes, even if you are a computer novice.

Report Card tracks up to 300 students on one diskette, holds up to 40 students per class and 50 activities per student. It correctly handles "incompletes," calculates student and class averages, and ranks students with various printing and sorting options. And it has a built-in editor which makes it easy to make corrections and remove incompletes.

REPORT CARD™

including software, manual and tutorial is available for Apple and IBM PC computers for \$59.95.

Apple and IBM PC are trademarks of Apple Computer, Inc. and International Business Machines Corp. respectively.



Sensible Software, Inc.®

210 S. Woodward, Suite 229,
Birmingham, MI 48011 (313) 258-5566

38 Circle 242 on Reader Service Card.

REVIEWS

the Public.Access section, I let callers view our editorial calendar for 1986, check our authors' guidelines, and leave queries for the editors. In the Private.Access section, I set up mailboxes for editors and frequent contributors. We asked a few *inCider* regulars to submit their columns and features via Let's Talk.

Since the system was running on a borrowed modem, it was up for only about three weeks (and only at night). Response was favorable, though. Authors especially liked not having to play "telephone tag" with editors—Let's Talk saved them time and aggravation. It also provided a fast, easy way to get their manuscripts into the hands of the editorial staff.

Let's Talk worked without a hitch. It proved to be much more flexible and convenient than a mere bulletin-board system. And from the operator's point of view, Let's Talk is easy to maintain. It gives people who aren't experts in telecommunications the opportunity to take advantage of the communications potential of their Apples.

Thorns Among the Roses

My major problem with Let's Talk concerns the documentation. Its approach isn't "how-to" enough to be much help to the average user. Luckily, the presentation disk makes up for the manual's deficiencies. The examples on the presentation disk are their own best documentation.

My other gripes are minor. For instance, I didn't especially like the editor that comes with Let's Talk, so I simply used my own word processor.

Conclusion

Let's Talk is the best messaging system available for the Apple II. I recommend it for small and medium-sized businesses (and for departments of larger organizations) needing a fast, economical way to disseminate information. Although I found the generic presentation disk to be more than adequate, Russ Systems plans to market Let's Talk with a number of different presentation disks, each directed toward a specific vertical market, such as lawyers and educators.

Let's Talk isn't perfect, but for the price, you won't find a better, more powerful solution to your problems of information distribution. ■

**Bob Ryan
Sharon, NH**

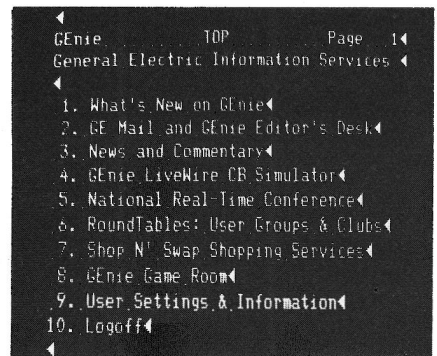

Connecting for Less

VIEWTRON

Viewdata Corporation of America,

1111 Lincoln Road, 7th Floor, Miami Beach,
FL 33139

Information utility; any Apple II, modem
Free starter kit (\$2.50 postage);
\$.09/minute, 6 p.m. to 7 a.m. M-F and
weekends;
\$.22/minute, business hours

Ease of setup	■ ■ ■ ■
Ease of use	■ ■ ■ ■
Documentation	■ ■ ■
Support	■ ■ ■
Overall	■ ■ ■ ■

GENIE

General Electric, 401 North Washington
Street, Rockville, MD 20850

Information utility; any Apple II, modem
\$18, sign-up charge
\$5/hour, off-peak; \$35/hour, peak (300/1200
baud);
\$15/hour off-peak; \$45/hour, peak (2400
baud)

Ease of setup	■ ■ ■ ■
Ease of use	■ ■ ■
Documentation	■ ■ ■
Support	■ ■ ■
Overall	■ ■ ■

If imitation is the sincerest form of flattery, then CompuServe Information Service must be sporting quite a corporate blush lately. Would-be competitors Viewdata and General Electric, undoubtedly marking the success of CompuServe's telecommunications gold mine, have opened what you might call "roadshow" versions of C.I.S.

Sophisticated Organization

Viewdata's entry, Viewtron, is the more sophisticated of the two new services, offering a wide selection of

MANAGE YOUR BUSINESS, NOT YOUR BOOKS!

INTRODUCING BusinessWorks™



Courtesy of Apple Computer, Inc.

Apple is a registered trademark of Apple Computer, Inc.
AppleWorks is a trademark of Apple Computer, Inc.

You've put time and energy into building your business. Now take the next step. Meet BusinessWorks, the ultimate business accounting package for people who demand high performance.

BusinessWorks offers you complete financial control over your company. Comprehensive reporting capabilities, including summary "flash" reports, help you make vital management decisions. And, BusinessWorks

allows you to analyze your financial information in AppleWorks, the best-selling integrated software package.

Designed specifically for Apple's new high-powered computers, BusinessWorks includes five full-featured accounting applications. With help messages at almost every point, and "show" windows that display needed codes or IDs, it's incredibly easy to use.

See it for yourself! Visit your dealer today for a demonstration, and get down to business — with BusinessWorks.



Developers of The Business Accountant™
and The Advanced Business Accountant™

(916) 781-3880

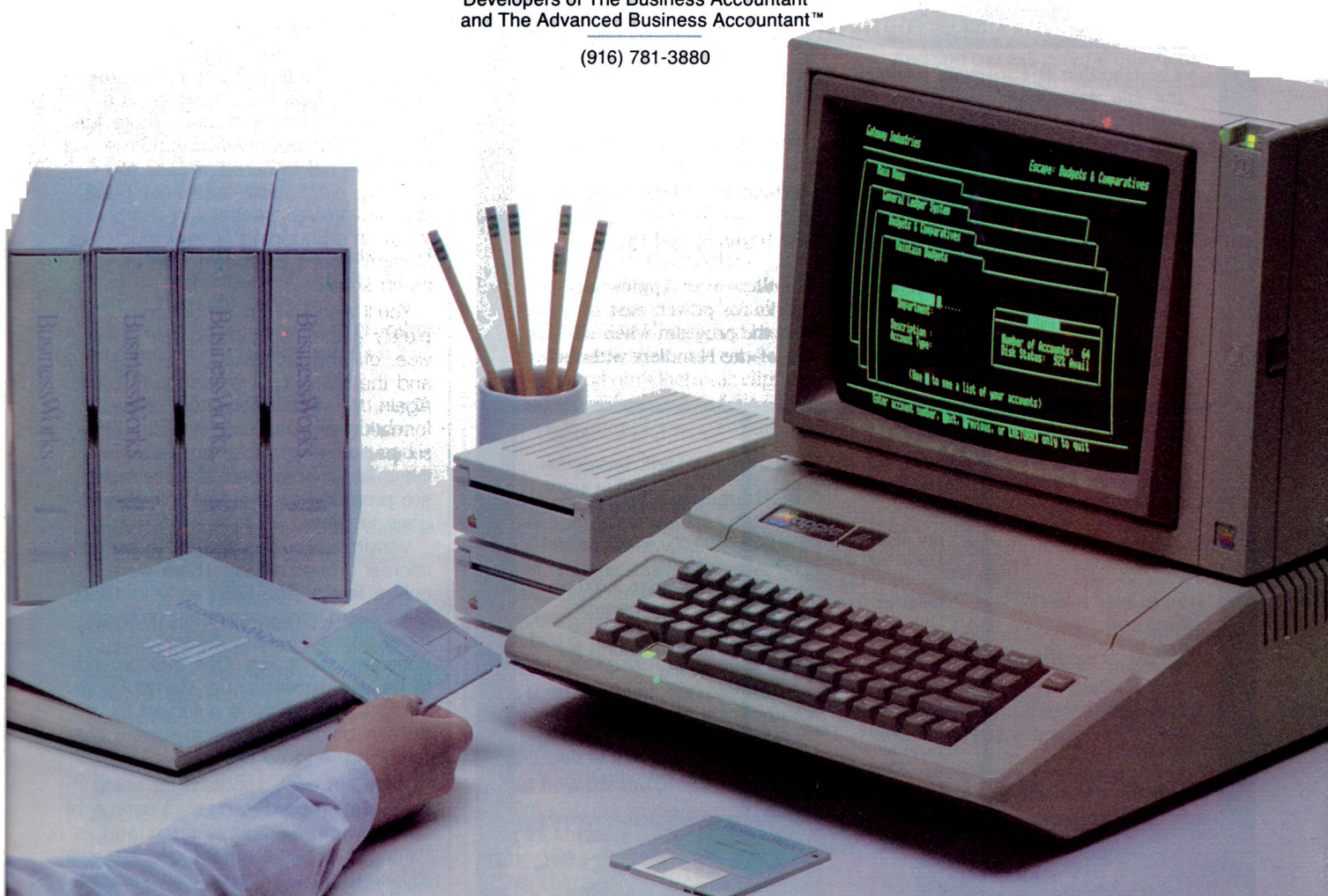

BusinessWorks, Manzanita Software Systems and the Manzanita logo are trademarks of Manzanita Software Systems, Inc.
© 1985 Manzanita Software Systems, Roseville, CA 95678.

Circle 241 on Reader Service Card.

the features one has come to expect from information utilities.

Joining Viewtron is refreshingly inexpensive. The starter kit, which includes a hardware-specific communications-software disk and manual, is free (with \$2.50 postage and handling). Once you've logged on, the evening connect charge is 9 cents a minute (6 p.m. to 7 a.m. Monday through Friday and all weekend), and 22 cents a minute during business hours. There's no minimum monthly

charge (à la The Source) and no supplementary charge for 1200-baud modems (à la almost every other information utility). Charges are billed directly to your Visa, MasterCard, or American Express card.

Superior organization and ease of use differentiate Viewtron from the competition. It's very easy to navigate within the system. Rather than memorizing page numbers or abbreviations, as you must to use The Source and CompuServe, just type a keyword on

the command line. The words are logical and simple to remember. For example, if you want to play games, type GAMES. If you want to talk on CB (on-line conferencing), type CB. If you want to go shopping, type SHOPPING. Commands don't come any easier than that.

A Range of Services

Viewtron's content is quite similar to CompuServe's. Its features include CB, special-interest groups, and electronic mail (the easiest to use I've ever seen). There are also news services of every kind; shopping, and games—word games, trivia, and so forth, but no mega-adventures like those on CompuServe. You'll also find travel information (including an Official Airline Guide, with a flight-booking feature for an additional fee), and stock quotes (also for an extra fee).

Viewtron differs from CompuServe, The Source, and other services not so much in the types of services it offers as in their extent and quality. In Shopping, for example, you won't find any CompuStore, but you do get a crack at J.C. Penney and Burdines catalog computers. There's also the BidQuik on-line auction, which is a continuous event and much more fun than the CompuServe/CompuStore version. Finally, there's access to clothing, electronics, and other goodies with on-line ordering. In short, Viewtron's Shopping is very much like CompuServe's Electronic Mall—just much smaller.

You'll also find an almost completely automated home-banking service, offering bill-paying, checking, and the name of a participating bank. Again, Viewtron differs from other information services only in scale. Only six participating banks are listed in the manual I received, though more are promised by the time this review goes to press.

Viewtron provides access to special-interest groups (SIGs). There were only a few on-line SIGs early in 1986, but system announcements promise more on hardware, software, and noncomputer topics. One SIG proved to be very similar to the CompuServe version, with sections reserved for a bulletin board, club news, on-line conferencing, and so on.

A built-in control system for using the bulletin board is one advantage of this Viewtron SIG. Topic areas and "strings" of related messages are well indexed, making the desired material easy to find. It's easy to skip over un-

THE HANDLERS

VALUE • POWER • SOPHISTICATION • SIMPLICITY

- The Handlers is a software package of three programs; word processing, file management and a spell checker for the Apple II, II+, IIe and IIc.
- The Handlers is *the* answer to programs that cost a lot, take a lifetime to learn and then don't deliver!
- The Handlers delivers the power and sophistication of large scale mainframe systems.
- The Handlers makes immediate sense to the beginner and the experienced computer user.
- More and more people are selecting the Handlers over Appleworks. *Why?* Because the Handlers beats Appleworks for power, ease of use and price! We took the difficulty out of the program when we engineered it so you get what you want out of the Handlers without wasting time.

WORD HANDLER

This best selling WP is surprisingly powerful and yet easy to use.

- Global search & replace
- Block moves
- 40, 66 & 80 column
- Form generator
- Easy to remember mnemonic commands
- Unlimited tabs
- Bold, underline, superscript, justification
- What you see on screen is what you get

LIST HANDLER

A truly fast & efficient file management program.

- Over 3,000 records per disk
- Up to 200 characters per field and 255 fields per record
- Unlimited sorting fields
- Sorts alpha, numeric and date sorts
- Merges with word processors, create form letters
- Sorts 3,000 records in under 45 seconds

SPELL HANDLER

The spell checker that works hand in glove with the Word Handler.

- 90,000 words on one diskette
- Add up to 2,000 of your own words
- No disk swapping
- Scans 10 words per second
- Word count
- If you knew what we know about our products, you'd be our next customer!

Circle 23 on Reader Service Card

Advanced Logic **als** Systems, Inc.

1195 E. Arques Avenue • Sunnyvale, CA 94086 • 408/730-0307

\$99.95



SOME HISTORIC BREAKTHROUGHS DON'T TAKE AS MUCH EXPLAINING AS COMPU SERVE.

But then, some historic breakthroughs could only take you from the cave to the tar pits and back again.

CompuServe, on the other hand, makes a considerably more civilized contribution to life.

It turns the personal computer into something useful.

CompuServe is an information service. Just subscribe, and 24 hours a day, 7 days a week, a universe of information, entertainment and communications is at your service.

A few of the hundreds of things you can do with CompuServe:

COMMUNICATE

Easyplex™ Electronic Mail puts friends, relatives and business associates in constant, convenient touch.

CB Simulator lets thousands of enthusiastic subscribers "chatter away" on 72 different channels.

Over 100 Forums welcome you to join their online "discussions." They're for everyone from computer owners and gourmet cooks to physicians and game players.

Bulletin Boards let you "post" messages where thousands will see them.

HAVE FUN

Our full range of games includes "You Gussed It!," the first online TV-style game show played for real prizes; MegaWars III, the ultimate in interactive excitement; board; parlor; sports and educational games.

SHOP

THE ELECTRONIC MALL™ gives you 'round the clock shopping for name brand goods and services at discount prices from nationally known stores and businesses.

SAVE ON TRIPS

TWA Travelshopper™ lets you scan schedules and fares, find the best bargains and order tickets online.

A to Z Travel/News Service provides latest travel news plus complete information on over 20,000 hotels worldwide.

MAKE PHI BETA KAPPA

Grolier's Academic American Encyclopedia's Electronic Edition is a complete, constantly updated general reference encyclopedia.

The College Board, operated by the College Entrance Examination Board, helps you prepare for the SAT, choose a college and get financial aid.

BE INFORMED

The AP News Wire (covering all 50 states and the nation), the Washington Post, USA TODAY Update and business and trade publications are constantly available. And our electronic clipping service lets us find, clip and file specific news for reading at your convenience.

INVEST WISELY

Comprehensive Investment Help includes complete statistics on over 10,000 NYSE, AMEX and OTC securities. Historic trading statistics on over 50,000 stocks, bonds, funds, issues and options. Five years of daily commodity quotes. Standard & Poor's. Value Line. And over a dozen other investment tools.

Site II provides demographic and sales potential information by state, county and zip code for the entire country.

And now for the pleasant surprise.

Although CompuServe makes the most of any computer, it's a remarkable value. You get low start-up costs, low usage charges and local-phone-call access in most major metropolitan areas.

Here's how to use CompuServe.

CompuServe is "menu-driven," so beginners can simply read the lists of options on their screens and then type in their selections.

Experts can just type in "GO" followed by the abbreviation for whatever topic they're after.

In case of confusion, typing "H" for help brings immediate instructions.

And you can ask general questions either online through our free Feedback service or by phoning our Customer Service Department.

How to subscribe.

To access CompuServe, you'll need a CompuServe Subscription Kit; a computer, terminal or communicating word processor; a modem and in some cases, easy-to-use communications software.

With your Subscription Kit, you'll receive a \$25 usage credit, a complete hardcover Users Guide, your own exclusive user ID number and preliminary password, and a subscription to CompuServe's monthly magazine, *Online Today*.

Subscription Kits are available in computer stores, electronic equipment outlets, retail stores and catalogs. You can also subscribe with materials you'll find packed right in with many computers and modems sold today.

Make a move of historic proportions. Subscribe to CompuServe today.

To receive our free informative brochure or to order direct, call or write:

CompuServe®

Information Services
P.O. Box 20212, 5000 Arlington Centre Blvd.
Columbus, OH 43220

800-848-8199
In Ohio, call 614-457-0802

wanted memos. Special-interest clubs are available, offering further communion among kindred spirits. I saw a few hardware-specific clubs and a general-interest club when I "visited."

News services reflect Viewtron's organizational flair. Stories are broken up into regional and topical categories. Stories appear on menus and are dated, so you'll be able to find the latest edition without wasting time—and money—browsing through entire files of articles.

On-Line Conferencing

CB is probably the most popular service on any utility offering it. Viewtron's CB is adequate, but it provided only five channels when I monitored it in January, and those were drastically underutilized. Viewtron's CB is as dull as CompuServe's is raunchy and witty. There's an atmosphere of rigid monitoring on Viewtron's CB. Only an on-line CB with liberal standards of expression and perfect isolation for "private" talkers can hope to compete with CompuServe's version.

The other problem with the Viewtron CB is the way it handles text entry. The CB is normally in text-display mode. You have to jolt it into text-entry mode with a command before you can write (for example, Apple users must press F3). It's a pain in the neck to have to keep hitting those keys before you can type in text. Equally annoying is having to keep track of what you're typing so that you don't overflow a 20-character line. At the end of a line, you have to type a TAB command to continue writing. All this does is slow up the pace of the CB.

Despite some problems with its CB, Viewtron has a lot of potential. It comes more or less full-flower, with a number of features and special services in place. All it needs now is subscribers. So far it has about 15,000—not a bad start for being on line nationally only since last fall.

CompuServe Junior

G.E.'s GENie system, on the other hand, has a lot of growing up to do.

At the start of 1986, it was pretty much a CB with a few information utilities tacked on, at a cost of \$5 an hour off-peak.

This information service will probably be voted "Closest CompuServe Look-Alike." The command structure is slightly different—you can use a few keywords or page numbers from an on-line index—but the on-screen appearance and organization are very close to CompuServe's.

GENie's categories of service consist of E-mail, news, CB, real-time conferencing, clubs and SIGs, shopping, games, and various help files. The problem is that none of these categories is very full, with the exception of CB.

CB enthusiasts won't be disappointed with the GENie version, since it works like CompuServe's (the commands are only slightly different) and costs a buck less per hour. All the GENie CB needs is more users. As with Viewtron, it was a very quiet Saturday night on GENie CB.

SIGs and clubs are almost excluded. *Continued on p. 98.*

COLOSSUS is the most complete chess program available for the **CBM™ 64/128** and **APPLE™ 2 Series**, written using the very latest techniques by a computer chess programmer of eight years experience. It has the widest range of true features available, including some never before implemented on *any* home computer chess program.

COLOSSUS has a perfect understanding of *all* the rules of chess, including under-promotions, the fifty move rule and all draws by repetition. It can handle standard mates; including the very difficult King, Bishop and Knight versus King.

COLOSSUS also offers the choice between the usual two dimensional flat board display or the new three dimensional real life board which allied to optional joystick control makes it clear and easy to use. It comes with a comprehensive instruction manual and is easily the best chess program for casual and serious players alike.

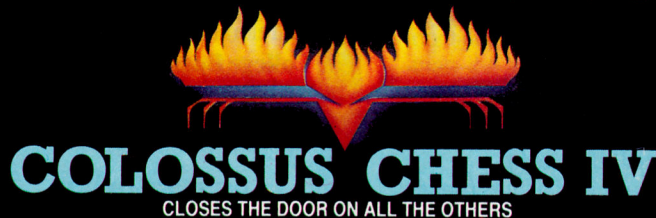
COLOSSUS CHESS IV

CLOSES THE DOOR ON ALL THE OTHERS

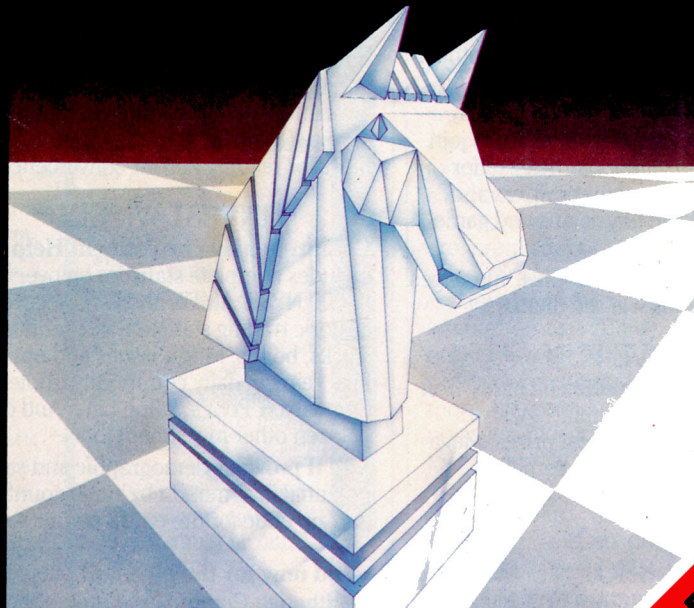

FACTSHEET/ORDER HOTLINE: 201.934.7373

FIREBIRD LICENSEES INC. 74 NORTH CENTRAL AVENUE RAMSEY NEW JERSEY 07446

(201).934.7373

APPLE 2 Series
CBM 64/128

MultiScribe™

Creative Writing for Your Apple® IIc™/Ile™

Now your Apple IIc or Ile can offer you the type of creativity that you might have thought was available only with a Macintosh.™ MultiScribe is a full feature word processor that uses double hi-res and proportional spacing to give your Apple all the character of a Mac.

You supply the imagination, MultiScribe does the rest.

There are no complicated commands to learn. Easy to use pull-down menus provide you with a wide range of type styles, character sizes, and text formatting options. You can choose the typeface that's right for your text—or create your own custom fonts with MultiScribe's font editor. And MultiScribe gives you writing style—any style, from bold and underline to italic, outline and shadow—just like MacWrite.™

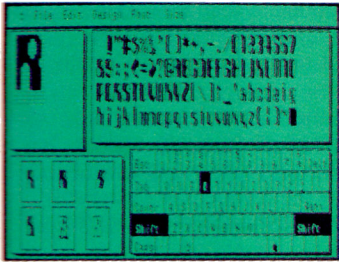

Pictured above: MultiScribe's font editor.



If you're afraid of mice, don't worry.

With MultiScribe, you have the option of using a standard keyboard or a mouse. Use your mouse to pick and click commands from the pull-down menus ... or use the arrow keys for "keyboard mouse" action. Each MultiScribe option has a keyboard equivalent displayed right on the menu, giving you the best of both worlds.

Don't upgrade your old computer, just your old files.

MultiScribe works with any IIc or Ile equipped with extended 80 column card and most dot-matrix printers, including Imagewriter,™ Epson,® and Okidata.® You can even use MultiScribe to customize files created by other word processing programs.

And best of all—the price.

MultiScribe is available for only \$59.95. Just complete and mail the coupon below or call our toll-free number, 1-800-233-4088 (in Texas call 1-713-771-4627).

\$59.95

+ \$3.00 shipping & handling
Texas residents add 5½% sales tax.
Outside U.S. add \$10.00.
Make check or bank order payable to:
StyleWare, Inc.

Name		
Street		
City	State	Zip
<input type="checkbox"/> MasterCard®	<input type="checkbox"/> Visa	<input type="checkbox"/> Check/Money Order
Card#	Exp. Date	
<input type="checkbox"/> 5¼" Diskette	<input type="checkbox"/> 3½" Diskette	

MultiScribe™
 Creativity at your fingertips.

StyleWare, Inc.
 6405 Hillcroft, Suite 201, Houston, Texas 77081

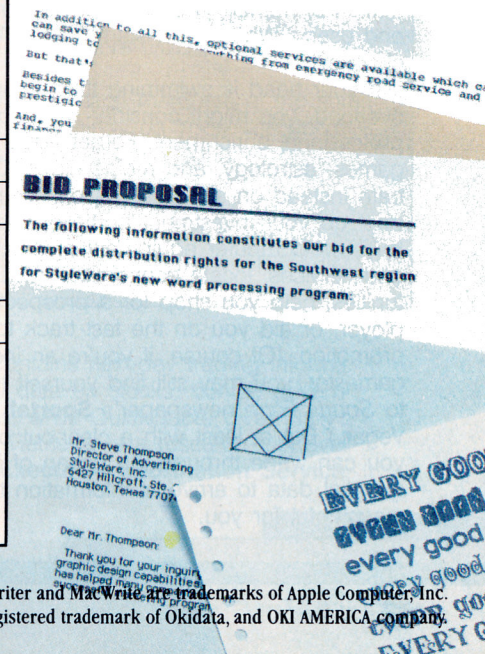

MultiScribe is a trademark of StyleWare, Inc. Apple is a registered trademark of Apple Computer, Inc. Apple IIe, Apple IIc, Imagewriter and MacWrite are trademarks of Apple Computer, Inc. Macintosh is a trademark licensed to Apple Computer, Inc. Epson is a registered trademark of Epson America, Inc. Okidata is a registered trademark of Okidata, and OKI AMERICA company.

For fun and profit,
let on-line data
bases show you
the world of
information
at your fingertips.

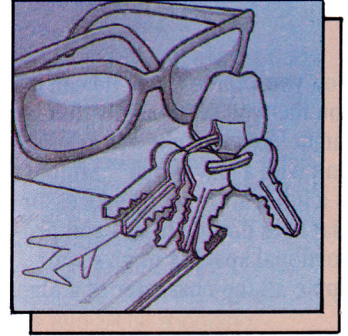

WHAT'S

by Wendy Lea McKibbin, *inCider* staff

If you're a professional using your home computer to run a business or catch up on some work, chances are you've already discovered the world of on-line resources. You know that with an outlay of less than \$100 for a 300-baud modem, you can tap into information as diverse as the current movies playing in Boston, to free advice for animal-rights workers on a bulletin board in Colorado.

Electronic services for shopping and banking, news, weather, and sports reports, electronic mail, guides to travel fares, business-information data bases, and free bulletin boards on everything from hobbies to patent laws—perhaps you've already encountered this mind-boggling smorgasbord of information and share the common dilemma of the end user: "Where do I start?" and "What do I choose?"

If your head is swimming from information overload, you might consider going on line for professional enrichment. Forget adult fantasy games, astrology, and recipe clubs. Concentrate instead on services that can help you beef up your investment portfolio, find the best buys on computer equipment or other goods and services, locate economical travel opportunities, help you shop for a prospective employer, or aid you on the fast track to promotion. (Of course, if you're an incurable gamer, you may still find yourself tuning in to *Sports Form* newspaper's **Sportel** from Las Vegas.) But at least with a clear-cut objective, you can wade through the ocean of inconsequential data to arrive at information that's meaningful for you.

Going On Line for Profit

"Information is power" is the cliché of the '80's, but it's nonetheless true when it comes to investments. Elizabeth Ferrarini, author of *Infomania*, relates in her book that a teenager in Framingham, Massachusetts, became so eagle-eyed at watching the stock market through the Dow Jones News/Retrieval Service that he parlayed a \$50 birthday gift into \$5000.

Investment information is often the lure that tempts the computer user to take his or her first plunge into on-line searching. Fortunately for the neophyte, several excellent sources await. Probably the three most widely known vendors in this field are **The Source**, **CompuServe**, and the

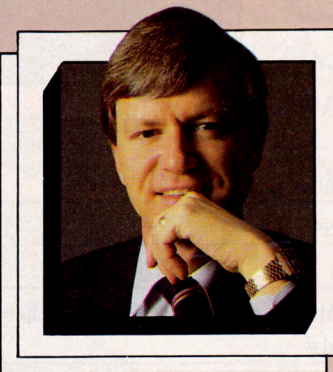

FRED MIDDLETON

LOCATION: San Francisco, CA

PROFESSION: President of Morgan Stanley Ventures, formerly chief financial officer of Genentech Inc., a genetic-engineering technology firm.

SERVICES USED: Dow Jones News/Retrieval Service and associated data bases.

Fred Middleton spends a couple of hours each week tracking more than 100 companies, looking at earnings estimates, financial forecasts, and product news. By closely watching the larger companies, he can identify opportunities for smaller companies.

"Following the trends and developments at larger companies in the industries we watch in the on-line data base helps us make better decisions in funding new-product development at smaller companies."

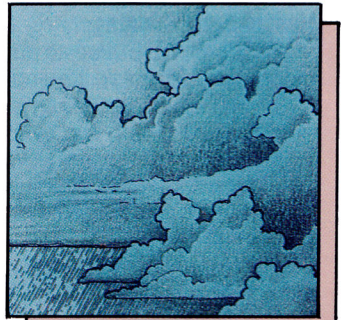
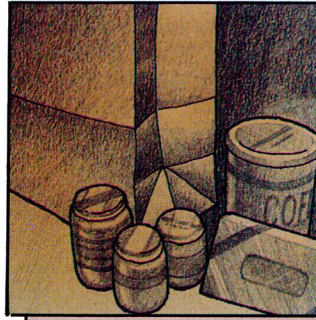
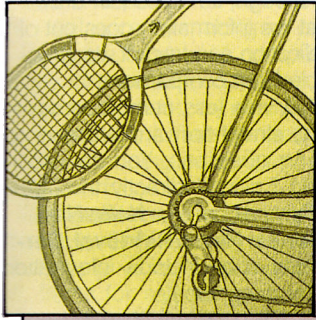

ON LINE?

Dow Jones News/Retrieval Service, although **Nite-Line** also delivers a credible product at a bargain price.

The Dow Jones service, owned by Dow Jones & Company in Princeton, New Jersey, tracks more than 6000 companies, 30 major industries, and a number of U.S. and foreign government agencies. Its four most important data sources of investment information are **Dow Jones Quotes/Current**, **Dow Jones Quotes/Historical**, **Media General Financial Services**, and **Corporate Earnings Estimator**.

Quotes/Current gives price updates for stocks listed on the New York, American, Midwest, and Pacific stock exchanges and the NASDAQ Over-the-Counter market. Quotes/Historical provides quarterly, monthly, and daily summaries on common and preferred stocks for the same markets. For the historical performance of a common stock traded on the New York, American, and OTC exchanges, try Media General, which tracks 3200 stocks and certain industry groups. For a look ahead, the Corporate Earnings Estimator projects earnings per share for 2400 major firms.

Other noteworthy data bases on Dow Jones include **Disclosure II**, which monitors the financial health of more than 9900 publicly owned companies; Standard & Poor's **Online**; Money Market Service's **Economic and Foreign Exchange Survey**; and Zachs Investment Research's **Corporate Earnings Estimator**.

While Dow Jones may be king of the financial- and business-information services, The Source and CompuServe are no less viable resources for investors.

The two major financial data bases to watch on The Source are **Unistox** and **Stockvue**. Unistox reports daily activity on Wall Street while Stockvue, like Dow Jones' Media General Fi-

ancial Services, provides historical perspective.

CompuServe has three data bases of interest to the potential investor: **QuickQuote**, **MicroQuote**, and **Ticker**

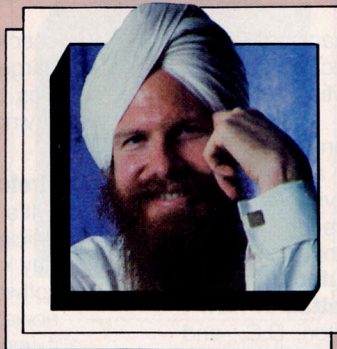

SAT TARA SINGH KHALSA

LOCATION: Chicago, Illinois

PROFESSION: Co-founder of Kriya Systems, Inc., creator of Typing Tutor III; managing general partner of Infotel, a resort hotel and conference center; founder of the Information Institute.

SERVICES USED: GTE Telenet, CompuServe Official Airline Guide.

Sat Tara uses Sikhnet on GTE Telenet to reach members of the same religious group. In a timely way, new teachings on Yoga, meditation, and nutrition are exchanged and jobs are sought and found.

"We are a several-thousand-person extended family. With Sikhnet, we can disseminate information quickly all over the country. We can keep up on what's going on with the latest teachings on Yoga and meditation."

Retrieval. MicroQuote contains next-day trading information, as well as historical data on stocks, bonds, government issues, and options, while QuickQuote gives daily price information. Ticker Retrieval is a research tool available on CompuServe's **Executive Information Service**. It

covers more than 9000 security issues and lists other information on prices and dividends.

Hassle-Free Banking

You don't have time to run to the bank with all the money you've made trading on Wall Street? Then consider



JON SHIRLEY

LOCATION: Bellevue, Washington

PROFESSION: President and CEO of Microsoft Corp., a major micro-computer-software developer.

SERVICES USED: Dow Jones News/Retrieval Service

Jon Shirley spends about five to 10 minutes on line every day checking on the prices of stocks, searching for information on the industry and other companies, and finding low-cost airfares. He spends about \$500 a year on it and finds it well worth the cost.

"I access the OAG through Dow Jones. It's excellent in finding direct lowest-cost flights. However, its ability to find connections rather than direct flights is limited."

another routing. This pocket-sized manual is published by Official Airline Guides, Inc., of Oak Brook, Illinois.

Like most printed directories, though, it has certain drawbacks. Chief among them is that the information goes out of date more quickly than the publication can track it. Its structure makes it difficult to do simple flight comparisons.

The electronic version of OAG is a less cumbersome approach to finding straightforward answers to your flight-scheduling questions. You can access the "Electronic Edition" directly through **GTE Telenet** or **Tymnet**, or via **NewsNet**, **Dialog**, or **Dow Jones News/Retrieval Service**. (The guide may soon include information on hotels and rental cars, too.)

When planning a trip, you might wish you had access to more information than just the best plane fares. If you'd like a good overview of transportation alternatives, accommodations, and things to do when you arrive in a city, you should add **Travel Scan's** phone number to your on-line directory. This comprehensive travel service, available through GTE Telenet or Tymnet, contains information on everything from airplane and bus schedules to special "get-away" packages and listings of restaurants, theatres, and other entertainment opportunities in the city of your choice.

Travel Scan, which can take you into the data base maintained by Pan American World Airways' reservation system, lets you do your own flight scheduling and ticketing electronically and pay for it with VISA or Mastercard.

If you'd love an exotic escape to Maui, but your budget can't keep pace with your mood, check out the New York-based service **CompuTrav**. A bargain-hunter's delight, CompuTrav tracks sudden vacancies on package air and sea tours and offers other cost-saving information on air fares and cruise tickets.

Stretching Your Dollars, Saving Your Time

It's probably safe to assume that anyone reading this article will periodically be interested in locating the best buy on new or used computer equipment and the right software for special applications. One of CompuServe's newest data bases, **MicroSearch**, is a good place to start if you're in the market for enhancements or a new system.

Produced by Information Inc. in Washington, D.C., MicroSearch is touted by its creators as one of the most comprehensive data bases ever compiled on the micro-computer industry. With thousands of product reviews from the 200 top computer magazines, MicroSearch provides a fast way to become acquainted with the best and the worst of the new offerings. The manufacturers furnish product literature and toll-free telephone numbers for more information.

If you're searching for software and want to get a bird's-eye view of the industry, check out the **International Software Database's Software Catalog** on Dialog. It covers more than 50,000 programs for micro-computers and larger systems.

What if you locate the software you need and want to purchase it on the spot? The **Electronic Catalog** lets you do it. Subscribers to this data base and shopping service, produced by One Point Corporation of Walnut Creek, California, can choose from major IBM PC and Apple software.

the fast-growing service known as home banking. California, Boston, and New York are the best locations for banking by modem, but many other institutions are eyeing the phenomenon.

For a nominal fee, you can pay bills, transfer funds, check your statements for the past month, and in some cases communicate with bank employees via electronic mail. The most prominent organizations offering home banking are **Bank of America** in San Francisco; **Shawmut Bank** of Boston; and **Citibank**, **Manufacturers Hanover**, **Chemical Bank**, and **Chase Manhattan** in New York. **Madison National Bank** in Washington, D.C., and **Louisiana National Bank** in Baton Rouge also offer successful services.

If you're interested in the ultimate convenience in personal money management, check with the larger institutions in your area to see if they've climbed onto the "bankwagon." If not, don't be discouraged. Experts predict that three-quarters of the commercial banks in the country will offer home banking via computer by 1990.

Travel the Friendly Skies

It's not unusual nowadays at trade shows or on airplanes to see businesspeople scanning copies of the **Official Airline Guide**, to find a better flight connection or

The Catalog evaluates the major IBM PC and Apple software packages according to error handling, documentation, ease of use, and price. You can save as much as 40 percent off the retail price by making an on-line purchase.

Even the most avid computer enthusiast occasionally shops for mundane consumer items like luggage, cameras, stereo equipment, or hardware. If you abhor crowded malls and don't feel compelled to touch what you buy, an on-line shopping service from GTE Telenet and Tymnet might be for you.

CompuStore, a service of Comp-U-Card International of Stamford, Connecticut, not only saves you time, but can offer many of its consumer products at up to 40 percent off. Items for sale range from electronic equipment to department-store merchandise to exotic foods. While not everything listed on CompuStore is a bargain, one young research analyst in New York swears that it saved his sanity one busy Christmas. So for your mental health alone, you might check out CompuStore.

The Resumé Game

Another type of shopping in which almost every professional engages at one time or another is job hunting. Whether you're looking for a new position, a whole new career, or a new employee, on-line resources can help.

Dialog, one of the largest search services in the world, is a good place to start when looking for a new job. As a first move, you might consider listing your employment profile in a Dialog data base produced by **Career Placement Registry** of Alexandria, Virginia. Here you can state your geographical preferences, pertinent job experience, educational background, and so on, and have it viewed by as many as 500 companies nationwide per month. It's also a good place to hunt for prospective employees. Depending on your anticipated salary, you pay a small fee of up to \$40 to be listed on the service for six months.

If you have a student in the family or you're looking for student help, consider the companion data base, **Career Placement Registry/Student**, from the same company. College seniors and recent graduates are listed for six months at a time during the current academic year. Career Placement Registry maintains full resumé for job hunters in both categories.

Don't want to pay to find a job in the computer industry? Consider **JobNet**, which caters to writers, engineers, and programmers in the high-tech industries, or **Softview**, which finds positions for data-processing professionals. Both data-base services let you list your resumé free of charge for an indefinite period of time.

For the impatient who would rather seek than be sought, an electronic classified-ad service called **CLEO** in Torrance, California, posts openings for engineers, technical writers, and other positions in leading electronics firms. For the cost of a phone call, you can find out what's stirring in Silicon Valley and other high-tech areas. If a job sounds interesting, leave your name and address in an on-line mailbox or mail a resumé to the company.

On Top of the News

Suppose you've just taken a new job and need to do a quick study of the company and its products, or, better yet, of the competition. Or maybe an important meeting looms ahead, and it requires you to be well informed about a particular issue. If so, you might want to tune in to the **news on Dow Jones**. This news data base consists of stories no more than 90 days old drawn from *The Wall Street Journal*, *Barrons*, and the Dow Jones wire service. Information more than 90 days old is stored in the **Free Text Search** data base on the Dow Jones News/Retrieval Service.

Sometimes a local newspaper, rather than a national publication, is a better source of information about a firm. If you're mining for information about companies located in Allentown, Lexington, Miami, Philadelphia, Sacramento, Washington, Boston, Detroit, Houston, Chicago, Wichita, or surrounding towns, consider subscribing to Knight-Ridder Newspapers' **Vu/Text Information Service**, which offers the full text of newspapers published in the cities mentioned above.

Of course, for serious research, every on-line addict should know about the incomparably rich resources of **Nexis**, produced by **Mead Data Central** of Dayton, Ohio. Nexis offers articles within 24 hours of their publication by 14 newspapers, top magazines from McGraw-Hill and Time-Life, multiple wire services, newsletters, and other sources. Although accessing Mead Data Central once required special equipment, it's now possible for owners of IBM and Apple personal computers to subscribe to the service.



ELIZABETH FERRARINI

LOCATION: Boston, Massachusetts

PROFESSION: Writer

SERVICES USED: CompuServe, Connexions Database (no longer in existence)

Elizabeth answered an ad for a research assistant at Houghton Mifflin Publishing on the Connexions Database. She didn't get the job, but met someone there to publish her book, *Infomania*. She will appear on the *Today Show* as a result of a message she left for the booking agent on CompuServe.

"The strength of the medium is in the connections it provides for you. If you're hunting for a job, going on line can be a good way to network."

Bulletin Boards

Bulletin boards deserve a special mention in a discussion of on-line resources. According to Matthew Lesko, author of **The Computer Data and Database Source Book** and **Information USA**, bulletin boards may be one

of the richest and most inexpensive sources of information around. If you look long enough and hard enough, you're bound to find a bulletin board on practically any subject of interest, from hobbies and programming languages, to free advice on almost anything.

A bulletin board in St. Louis answers questions about racquet sports; a Texas service addresses questions about copyright protection; a Colorado group posts information about animal welfare and protection; and a bulletin board in northern California caters to bicycle enthusiasts.

The best place to start looking for a bulletin board is your local computer club. Also check out The Source and CompuServe, or start subscribing to **Bulletin Board Systems** magazine, published in Westport, Connecticut. If all else fails, call your local computer dealer.

On-Line Romance

How can a single woman find 20 new men in two days? Try **CompuDate**, says Elizabeth Ferrarini, whose on-line ad on The Source in 1981 brought a flurry of response.

Her electronic S.O.S. to meet other professionals put her into contact with a colorful cast—including the owner of a radio station; a romeo from Florida "who made Burt Reynolds look sick"; a psychiatrist; a gynecologist; the son of F. Lee Bailey; and, of course, a few dozen hard-core computer enthusiasts.

"A lot of people like the electronics medium as a way to socialize," Ferrarini says. "It's anonymous, discreet, safer than a bar, and very intensive." She adds that if you want a real relationship, though, you must eventually make "the human connection."

Two people whose on-line friendship resulted in the ultimate human connection are Pamela Ann Falejczyk and Mark Crosby, who married in the Wayside Chapel in Palos Park, Illinois, last October after a ten-month courtship via modem. Naturally, the wedding was on line. While Mark and Pam took their vows at the altar, a volunteer from **People/Link**, the service that brought them together, transcribed the event on computer and broadcast it to guests

watching from Scotland, England, California, New York, Las Vegas, and other parts of the world.

Pam, formerly a customer-service manager for People/Link in Chicago, relates that she was nervous when she first met Mark face-to-face after months of on-line conversation. But at the same time, she says, "I felt as if I knew him." The couple discovered through their electronic communication that they shared an interest in photography, motorcycles, travel, and computers.

People/Link is a videotext service operated by American Home Network of Arlington Heights, Illinois, with about 4000 subscribers. It's but one of many outlets you might consider as a way to add fun, zip, and variety to your social life. Another is **Playnet** in Troy, New York, which hosts on-line parties, board games, bulletin boards, and E-mail. For the more adventuresome, there's a swinging adults-only service called **X-Net Computer Services** in Halesite, New York, and a **Gay News and Information and Communications Network** in Woodbury, New York.

Of course, CompuServe and The Source are good places to seek people with similar interests. On The Source you can "type-talk" on "Chat" with other subscribers, or try your hand at CompuDate. Like The Source, CompuServe has a type-talk feature. Or if you prefer, games, interesting forums, electronic mail, and bulletin boards are available.

Are you ready to make friends around the country or even around the world? Are you tantalized by the prospect of becoming an electronic voyeur? If so, then give yourself a "handle" (that's a name, for you non-CB radio buffs) and dial up an adventure.

Taking the Plunge

If you're ready to go on line, keep a few simple rules in mind. It's best to start by defining your objectives, before you run up costly connect charges in what may be a fruitless search. Take some time to research your area of interest. Excellent directories are available to guide you through the seemingly endless stores of electronic information. And don't overlook organizations such as the **Information Industry Association** and the **Videotext Industry Association** as places to get ideas.

Finally, consider the alternatives. The information you need may be available from a free government-agency data base, a local bulletin board, or a free pamphlet. Do your homework and you won't end up paying for information you could get just as easily in another form. With a sound plan of attack, you're bound to get maximum mileage from your on-line dollars. ■

Write to Wendy Lea McKibbin at 1060 Marsh Road, Suite C-200, Menlo Park, CA 94025.



MARK and PAM CROSBY

LOCATION: Dallas, Texas

PROFESSION: Pam is a marketing coordinator at Future Computing Inc., Mark is a mechanical engineer at Watson Inc. in Fort Worth.

SERVICES USED: People/Link, a videotext network for social interaction.

Pam and Mark use People/Link as a way to make on-line friends. In fact, they actually met each other through the service.

"It's easy to become real close friends with the people you talk to on line. We found that the minute one of us would think about asking a question, the other thought about asking the same thing simultaneously."

Product Information

American People/Link

3215 North Frontage Road
Suite 1505
Arlington Heights, IL 60004
(800) 524-0100
(312) 870-5200 in Illinois
\$14.95 reg. fee (incl. first
3 hours)
\$3.95 300 baud,
standard time
\$4.95 1200 baud,
standard time
\$10.95 300 baud, prime
time (7 a.m.-6 p.m.)
\$12.95 1200 baud, prime
time

Reader Service Number 332

Bulletin Board Systems

Meckler Publishing
111 Ferry Lane West
Westport, CT 06880
(203) 226-6967
\$26.50 per year

Reader Service Number 333

Career Placement Registry

302 Swann Avenue
Alexandria, VA 22301
(703) 683-1085
\$95 per hour

Reader Service Number 334

CLEO

Computer Listings of
Employment Opportunities
2164 West 190th Street
Torrance, CA 90504
(213) 618-0200

Reader Service Number 335

CompuDate

The Source
Source Telecomputing
1616 Anderson Road
McLean, VA 22102
(703) 734-7500
\$49.95 for men (one-time
membership)
Free for women

Reader Service Number 336

CompuServe

5000 Arlington Center
Boulevard
P.O. Box 20212
Columbus, OH 43220
(614) 457-8650
\$39.95 one-time fee,
up to \$12.50 per hour

Reader Service Number 337

CompuStore

Comp-u-Card International
777 Summer Street
Stamford, CT 06901
(203) 324-9261
\$25 per year,
\$5 to \$18 per hour

Reader Service Number 338

CompuTrav

Lanexssa International
622 Broadway
New York, NY 10012
(212) 759-8555
\$30 one-time fee,
\$12 per hour

Reader Service Number 339

Dialog Information Services

3460 Hillview Avenue
Palo Alto, CA 94034
(415) 858-3792
\$6 to \$8 per hour

Reader Service Number 340

Dow Jones News/ Retrieval Service

P.O. Box 300
Princeton, NJ 08450
(609) 452-2000
\$75 one-time fee,
\$3 per month

Reader Service Number 341

Electronic Catalog

One Point Corporation
2835 Mitchell Drive
Walnut Creek, CA 94590
(415) 947-0850
\$35 one-time fee,
\$8 per hour

Reader Service Number 342

GTE Telenet

GTE Telenet
Communications
8229 Boone Boulevard
Vienna, VA 22180
(703) 442-1000

Reader Service Number 343

Information USA

4701 Willard Avenue, #1707
Chevy Chase, MD 20815
(301) 657-1200

Reader Service Number 344

JobNet

JobNet, Inc.
10 DeAngelo Drive
Bedford, MA 01730
(617) 275-3010
\$350 per hour

Reader Service Number 345

NewsNet

945 Haverford Road
Bryn Mawr, PA 19010
(215) 527-8030

Reader Service Number 346

Nexis

Mead Data Central
9393 Springboro Pike
P.O. Box 933
Dayton, OH 45401
(513) 865-6800
\$20 per hour

Reader Service Number 347

Nite-Line

National Computer Network
1929 North Harlem Avenue
Chicago, IL 60635
(312) 622-6666
\$30 one-time fee,
up to \$26 per hour

Reader Service Number 348

Official Airline Guide, Electronic Edition

2000 Clearwater Drive
Oak Brook, IL 60521
(800) 323-3537
\$50 one-time fee,
\$6 per hour

Reader Service Number 391

Softview

Software Career Link
67 South Bedford Street
Burlington, MA 01803
(617) 229-5813
Up to \$9000 per year

Reader Service Number 392

The Source

Source Telecomputing
1616 Anderson Road
McLean, VA 22102
(703) 734-7500
\$49.95 one-time fee,
\$.46 per minute

Reader Service Number 393

Sportel

Sports Form
P.O. Box 1182
Las Vegas, NV 89125
(702) 873-1151

Reader Service Number 394

Travel Scan

Travel Scan Videotext
5 Penn Plaza
New York, NY 10001
(212) 695-5492
\$50 one-time fee,
\$15.50 to \$19.80 per hour

Reader Service Number 395

Tymnet

OnTyme
Tymshare Corporation
20705 Valley Green Drive
Cupertino, CA 95014
(408) 446-6000

Reader Service Number 396

UniNet

10951 Lakeview Avenue
Lenexa, KS 66219
(800) 821-5340

Reader Service Number 397

Vu/Text

Vu/Text Information Services
1211 Chestnut Street
Philadelphia, PA 19107
(215) 663-3300
\$30 to \$300 per hour

Reader Service Number 398

Is keeping fit, managing stress, or balancing your diet needed in your life? Here's software to help you achieve your perfect self.



© PETER BOND

YOU CAN DO BETTER

by Cynthia E. Field

Thirty-six years ago Jan Smuts died. Were he alive today, *60 Minutes* would probably interview him about his experiences as former Prime Minister of South Africa.

But Jan Smuts was more than a military leader and a political figure in a troubled country. When he was middle-aged, he developed the theory we call Holism. Thanks to Smuts, we know we are not just gallons of salty water packaged in muscle and wrapped in skin. We know we're much, much more—or at least we strive to be.

During our 40,000-year journey on this planet we've gathered tools to help us work toward Smuts' holistic ideal: Literature. Medicine. Philosophy. Apple II's.

How can your Apple help you become a more well-rounded person? In this article, I've classified nearly three dozen products that claim to enhance the physical, mental, and emotional aspects of life.

All but a sprinkling of these products require only 48K and one disk drive. It's nice to know that you don't have to be a power user to increase your personal power.

On the Home Front

Psychologists tell us that one of our basic physical needs is shelter. No one has yet designed a computer that can pour a foundation or shingle a house. Programmers, though, have written software that can install partitions and move furniture around, at least figuratively.

For younger members of the family and adults who share the growing interest in miniatures (we used to call them doll houses), CBS Software has published **Dream House**. With this program, you can customize and furnish any of four different homes: a colonial farmhouse, a penthouse, a Victorian home, and a cottage.

While Dream House is a colorful outlet for creative play, programs from Avant-Garde provide you with the tools to put your *House Beautiful* fantasies into blueprint-like form. The **Design Your Own Home** series includes three separate packages: **Architectural Design**, **Interior Design**, and **Landscape Design**.

The Avant-Garde series brings computer-assisted design to the homebuilder-to-be. The programs calculate distances and angles, give you scale diagrams, and provide you with an inexpensive way to experiment with different plans. The series uses standard architectural symbols and prepares printouts for your contractor, interior decorator, or landscape designer.

Here's to Your Health!

We've come a long way since snake-oil days. Quality medical care is a fact of modern life. We're more knowledgeable about our bodies and about what we should do to stay well. Much of this knowledge we've gained through books, magazines, and newspapers.

At least three software-based medical advisers are available. None of them claims to substitute for a physician; such a claim would be illegal and dangerous. These programs in large part do substitute for the written word; they are, more or less, electronic page turners.

Avant-Garde's program, **An Apple a Day**, claims to be a medical counselor that can save you time and money. The program contains a health-records and telephone-directory option. Both are merely index-card files on disk. As for advice, the fine print on the package reads in part: "Avant-Garde gives no assurance that the opinions or judgment of the author are reliable and accurate." A statement like that hardly instills confidence.

HouseCall '86 claims to be only what it is: a computerized *Home Medical Encyclopedia*. The program contains an indexed data base with hundreds of topics. You can search by index entry or by symptom. The program is much more comprehensive than An Apple a Day, and it provides information on timely topics like AIDS.

The best of the three, and the only one prepared by a medical doctor, comes in the plainest package. In the preface to **Personal Health**, Dr. Buckley humbly writes: "I have tried very hard to make the information available on this disk program as accurate as possible."

Personal Health contains more than a disability and disease data base. Dr. Buckley has included sections on Your Doctor, Medicines, Cancer, and Lab Tests. This program is probably the most holistic of the three. While not eschewing medical treatment when it's needed, Dr. Buckley seems to believe in letting the body heal itself whenever it can. Many of us would agree that "the fewest number of X-rays, hospitalizations, operations, and medicines, the better."

If you want or need more information about a particular subject, the Personal Health reference section contains about 100 entries from such well-regarded periodicals as *The New England Journal of Medicine* and respected medical-text publishers like W. B. Saunders.

FREE 15-DAY TRIAL OFFER

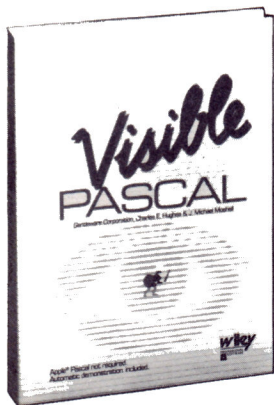

"Visible Pascal is one software package that anyone

considering learning a computer language should look into."

—Erik Sandberg-Diment
The New York Times
August 6, 1985

The critics are raving about **Visible Pascal**. **Visible PASCAL**, the first interactive learning tool, has added fun to learning the PASCAL programming language.

Take advantage of this **FREE 15-day trial offer**. Call **Wiley Professional Software** at **212-850-6788**.

Visible PASCAL \$59.95 ISBN 0471-88820-6

Developed by Genteware Corporation

Requirements: Apple® II, (with language card), II+, IIc or IIe, 64K RAM. Game paddles or joysticks recommended, though not required except for the Artist program.

Examine the documentation only **FREE** for 15 days. Either keep your **Visible PASCAL** and return the accompanying invoice with your payment (including postage and handling, plus local sales tax) or return it within 15 days without further obligation.

Note: Returns will not be accepted if the seal covering the program disk is broken.

Or write: Wiley Professional Software

Attn: Leslie Bixel
John Wiley & Sons, Inc.
605 Third Avenue
New York, N.Y. 10158



wiley
PROFESSIONAL SOFTWARE

Institutional discounts available.

Apple™ is a registered trademark of Apple Computer Inc.

Eat, Drink, and Be Merry

Your hurried, harried lifestyle probably makes it difficult for you to eat right. Despite your good intentions, many of the foods you find in the supermarket are sliced, diced, and spiced to death. While food-processing techniques provide us with a varied, safe food supply, some methods rob otherwise healthful foods of their nutritional value.

Your Apple II, as the speedy calculator it really is, can help tremendously with nutritious meal planning for you and your family. Without a computerized food data base, you'd need a copy of the U.S. Department of Agriculture's *Handbook No. 8*.

Once you found the food you were interested in analyzing, you'd probably have to do some mathematical conversions because the metrically thinking scientific community determined the recorded values for nutrients. After you'd converted the values for all the nutrients to ounces, cups, and slices, you'd go back and look up the next food. Believe me, this process gets stale pretty fast!

With computerized nutrition programs, you type in the food name, and the program searches its data base. When it finds the food, the program asks you what serving size to calculate. Most programs speak English—not metric. The process may seem slow compared to the speed with which your Apple can recalculate a spreadsheet or move Bruce Lee to karate-chop a foe. Realize, however, that using *Handbook No. 8*, a pencil, and a calculator is like being a scribe in a medieval monastery.

All three of the programs described here take into account the RDA (recommended dietary allowance) for important nutrients. RDA values vary with your gender and age. Pregnancy and breastfeeding also affect the RDA.

Nutriplan is a computerized version of *Handbook No. 8*. The program assesses 21 nutrients, including saturated fats, cholesterol, vitamins, and minerals. Its data base lists more than 400 foods, and you can add more. (Guess where you get the information. Right—*Handbook No. 8*, or a valid substitute.)

While **Nutriplan** is a "meat and potatoes" nutrition program, **Weight Loss and Nutrition Center** and **The Original Boston Computer Diet** add the condiments. Not only do these programs calculate the nutritional value of your food intake, but (Smuts, are you listening?) they counsel you!

Both programs are geared to helping you shed pounds and control your weight. In **Weight Loss and Nutrition Center**, Dan's your man. In **The Original Boston Computer Diet**, your counselor is George, Shirley, or Amy. Because eating is not just a physical event, but a psychological one as well, these programs help you deal with your reasons for eating. You become attuned both to your hunger level and your emotional state.

Both programs have modifiable food data bases and emphasize the importance of exercise as a great way to refresh the psyche and burn calories.

Aerobic Computing

Jane Fonda hasn't (yet) written a computerized exercise program. But the people at HRM have. **Cardiovascular Fitness Lab** brings some of the benefits of the local health club into your home. The program, which helps you determine your cardiovascular status and train for improved fitness, comes with a pulse sensor and an Apple IIe/II Plus interface card. A long extension cable lets you

Continued on p. 61.

Some More Facts About RAM Cards!

You could put a FLIPSTER or Apple™ 1 meg memory expansion card in slot 4 and add another FLIPSTER or Apple 1 meg memory expansion card in slot 5 (The FLIPSTER and Apple's card only expand to 1 meg). You'll need a separate 80 column card for the auxiliary slot. Oh, and put a printer buffer card in slot 2. If you want RGB color, you'll need an RGB board in slot 7 then buy a hard disk (if you have any slots left).

You'll have a bigger AppleWorks desktop, but you'll still be limited to a maximum of 1350 records in the data base. And you're stuck at 2250 lines in the word processor. And AppleWorks won't automatically load itself into memory, and make sure you don't create a file bigger than your disks can hold because neither FLIPSTER nor Apple's memory card will segment a file onto multiple disks.

Or You could get RamWorks II!®

You'll have a bigger desktop.

You'll also have up to 15,300 records (not 1350) in the data base and up to 15,300 lines in the word processor (not 2250). AppleWorks will now automatically load into RAM. And if you create a file greater than your disk capacity, no problem. RamWorks II will automatically save it on multiple disks. And because of our built-in printer buffer, you can continue to use AppleWorks while your printer is printing. Nice. RamWorks II has an RGB option, 16 bit option and is expandable to 5 megabytes. And don't forget, RamWorks II is the software industry standard for memory expansion in the IIe. RamWorks II is automatically recognized by virtually all memory intensive programs (and many more are on the way) and is 100% compatible with all IIe software. Clearly the new RamWorks II has more features, more capabilities, and most importantly, is recognized by more commercially prepared programs than any RAM card. RamWorks II is fully compatible with DOS 3.3, ProDos, Pascal 1.1, 1.2, 1.3 and all CP/M versions 2.2 through 4.0. No other memory card enhances software better. And RamWorks II is the acknowledged standard with all serious AppleWorks users.

There's only one card like RamWorks II. If someone tempts you with an imitation, please call us to get both sides of the story. You'll discover why RamWorks II offers the best enhancements to AppleWorks and a long list of other programs.

214-241-6060
9 AM - 11 PM
7 Days a Week

"We Set the Standard"
APPLIED ENGINEERING

	RamWorks II®	FLIPSTER/ Apple's Card
Maximum Desktop	2277K	1012K
Maximum Number of Records in Database	15,300	1350
Maximum Number of Lines in Word Processor	15,300	2250
Autoloads AppleWorks	YES	NO
Auto Segments Files	YES	NO
Built-in Printer Buffer	YES	NO
Compatible With All Versions of AppleWorks	YES	NO
Displays Time & Date on AppleWorks Screen with Clock	YES	NO
Saves Slots	YES	NO
RGB Option	YES	NO
16 Bit Co-Processor Port	YES	NO
Memory Expansion Ports	YES	NO
Patent Pending Power-Saving Circuit	YES	NO
80 Columns Built-in	YES	NO
Maximum Memory per Slot	5120 K	1024 K
Compatible with Franklin 2000 Software	YES	NO
Compatible with Auxiliary Slot	YES	NO
Software Standard	YES	YES
Manufactured in	USA	England/ Singapore
Warranty	5 Yrs.	1 Yr./ 90 Days
Price	LESS	MORE

AppleWorks and Apple are trademarks of Apple Computer.

HAVE YOU ST

| A

| 4B

| 3B

| 2B

| 1B

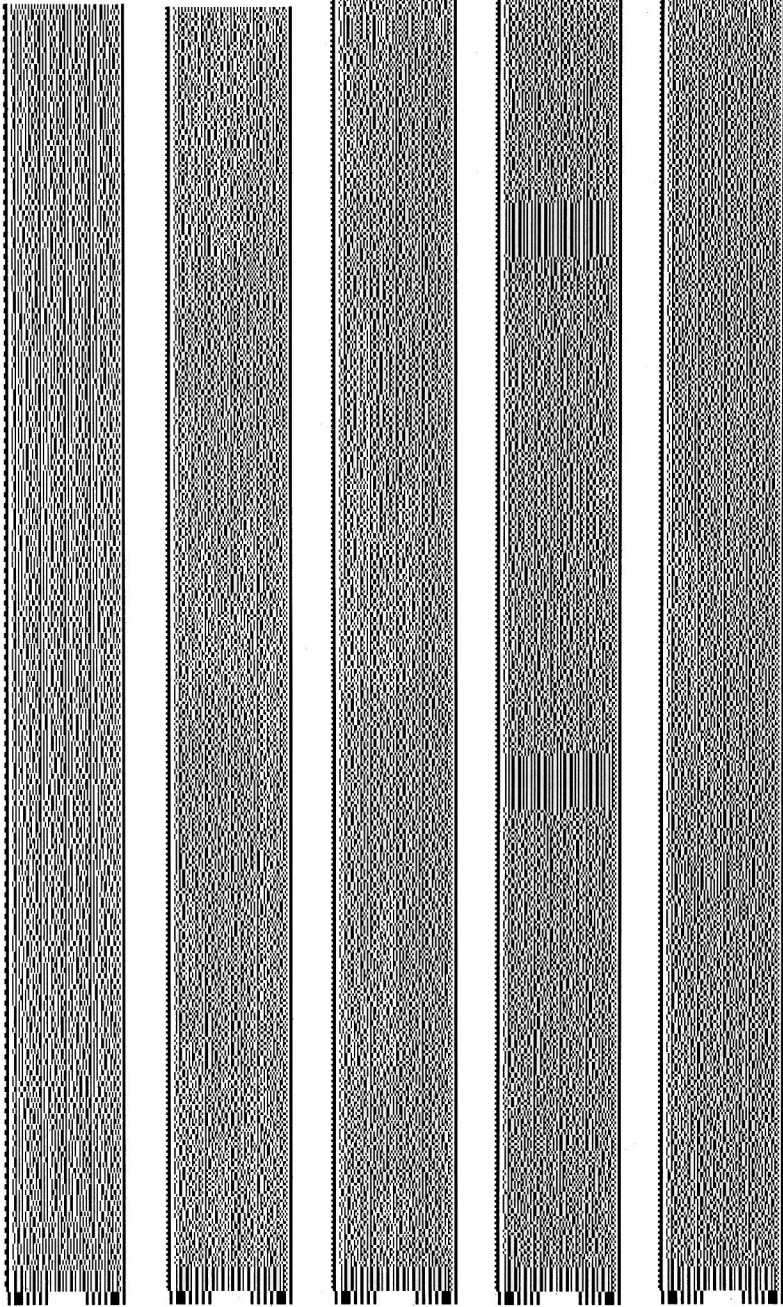

It's a question more and more Apple owners are asking. And no wonder. What everyone is talking about is Softstrip™. The revolutionary technology that is changing the shape of computer software.

The Cauzin Softstrip System is more than just software or data on paper. Because when you invest in this system, you can do much more with your computer, and for far less than you are probably spending now. You can even create and print out your own data strips.

But that's only the beginning of an offer that's going to make you wonder why you haven't stripped yet . . .

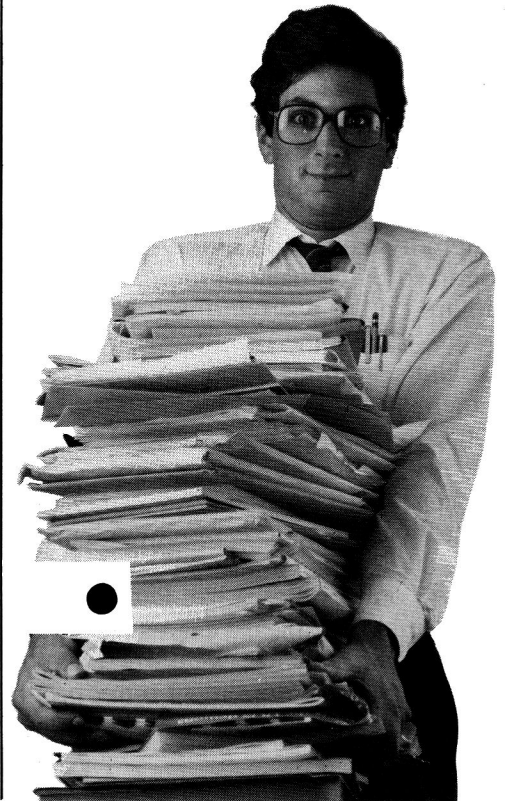

Softstrip
COMPUTER READABLE PRINT

RIPPED YET?

The data strips on these six pages feature nine entertaining programs and a directory. They include:

- A — Directory
- B — Softball Statistics*
track your favorite players with this sports data base
- C — Bubble Sort**
a colorful illustrated animation of a classic sorting technique
- D — Poster Printer*
express yourself by making banners and messages
- E — Tower Puzzle**
an intriguing full color version of Towers of Hanoi
- F — Bongo's Bash*
arcade style action in one challenging maze after another
- G — Starwatch**
test your knowledge of constellations and comets
- H — Robot Minefield***
a battle of wits and precision timing for survival
- Grand Prix***
life in the fast lane as you race to the checkered flag
- Kentucky Derby***
it's post time and the thoroughbreds are at the starting gate

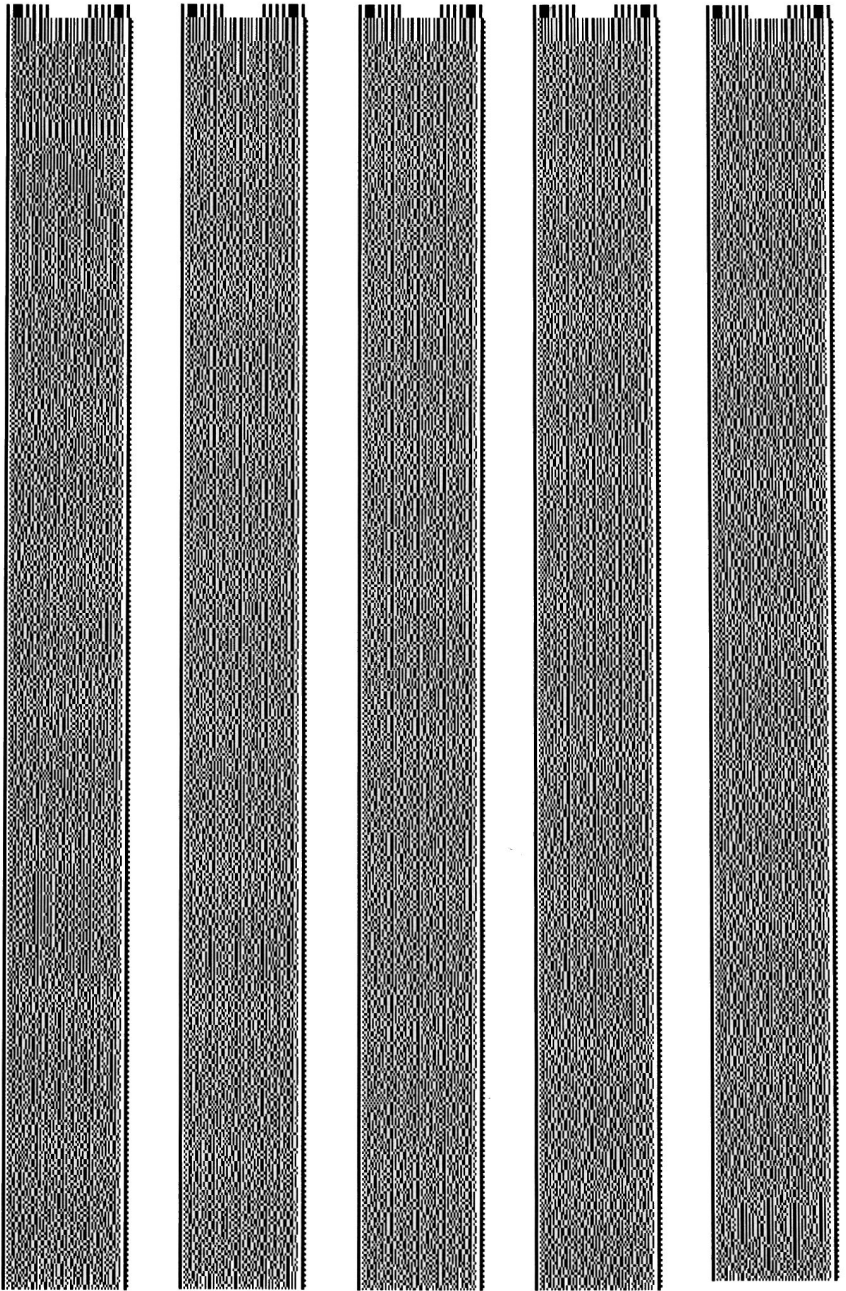

C 1 |

C 2 |

C 3 |

C 4 |

C 5 |

All of the programs are reprinted with permission as follows:

*from HotCider, Vol. I and II, copyright 1985

CW Communications/Peterborough

**from Uptime Magazine, copyright 1985 Viking Technologies

***from Tim Hartnell's Giant Book of Computer Games and Second Giant Book of Computer Games, copyright 1983, 1984, 1985 Tim Hartnell, published by Ballantine Books

StripWare Library Nos. 208-216

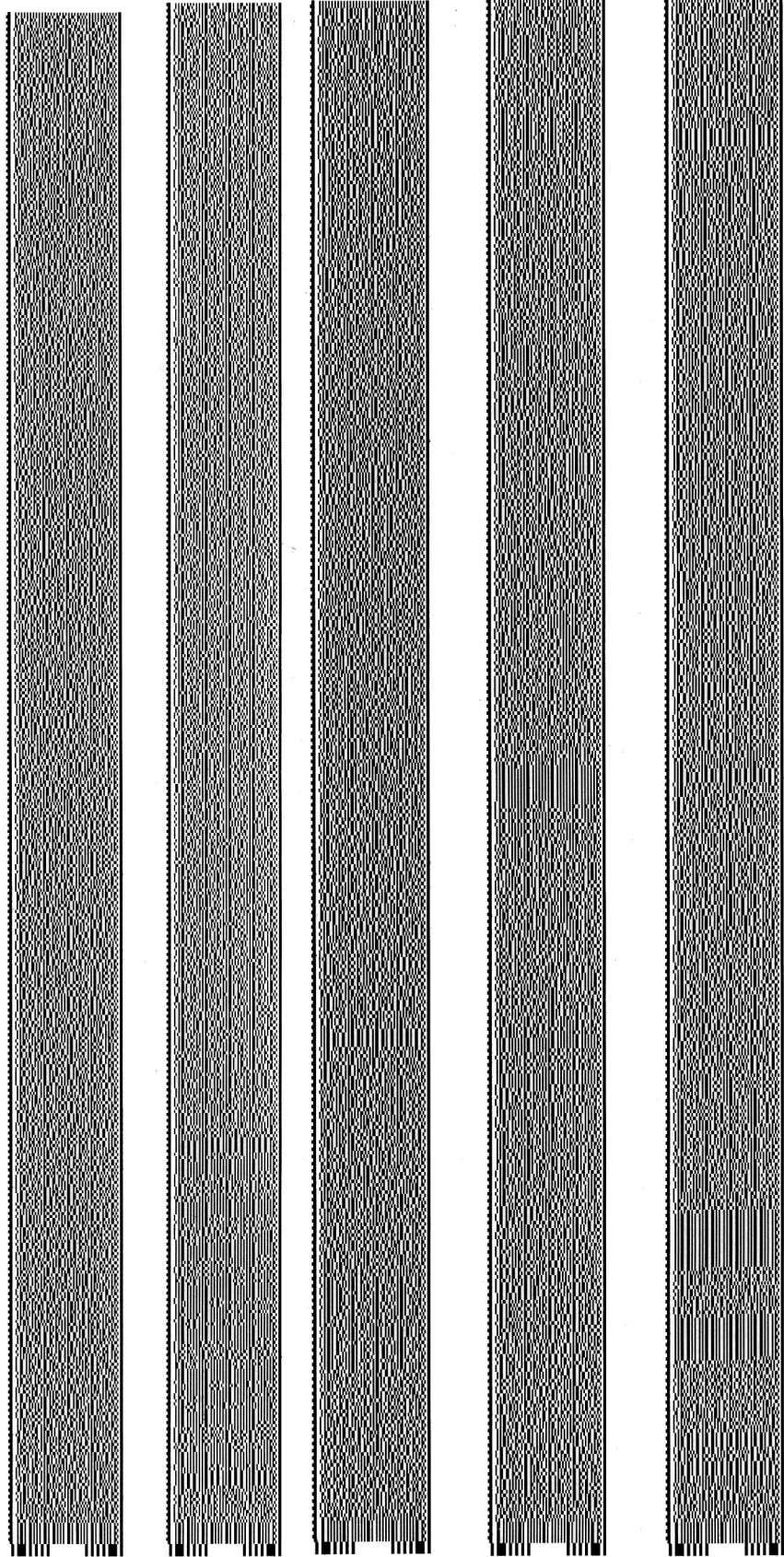

2 D

1 D

3 E

2 E

1 E

**TAKE OUR ADS
(SUCH AS THIS ONE)**

It's part of the expanding Cauzin StripWare™ Library containing programs, data, art, spreadsheet macros and templates. The Library features a variety of software applications and you'll find new material appearing each month in such leading magazines as A+, Call A.P.P.L.E., inCider, Nibble, and II Computing.

**BUT THERE'S
STILL MORE . . .**

When you invest in the Softstrip System, you get the Softstrip reader, a special storage base, and a full one-year replacement warranty. Also included with your purchase is a complete Accessory Kit containing connector cables and communications software to link your Apple to the reader.

In addition, you'll find a StripWare Library Sampler of 50 programs from a line-up of popular authors and publishers that includes Addison-Wesley, David Ahl, Family Computing, Hayden Books, Nibble/MicroSPARC, Osborne/McGraw-Hill, The Waite Group, John Wiley & Sons and many others.



When you become a Softstrip reader owner, you also get a FREE one year StripWare Club membership with programs mailed to you monthly. You'll even receive a FREE Cauzin Effect Newsletter filled with the latest updates and news about Softstrip developments.

There's also StripWare™ brand software in authorized Softstrip dealers across the country. Our collection of titles include everything from utilities, graphics and entertainment to business programs.

All for only
\$2.98 to
\$19.98!

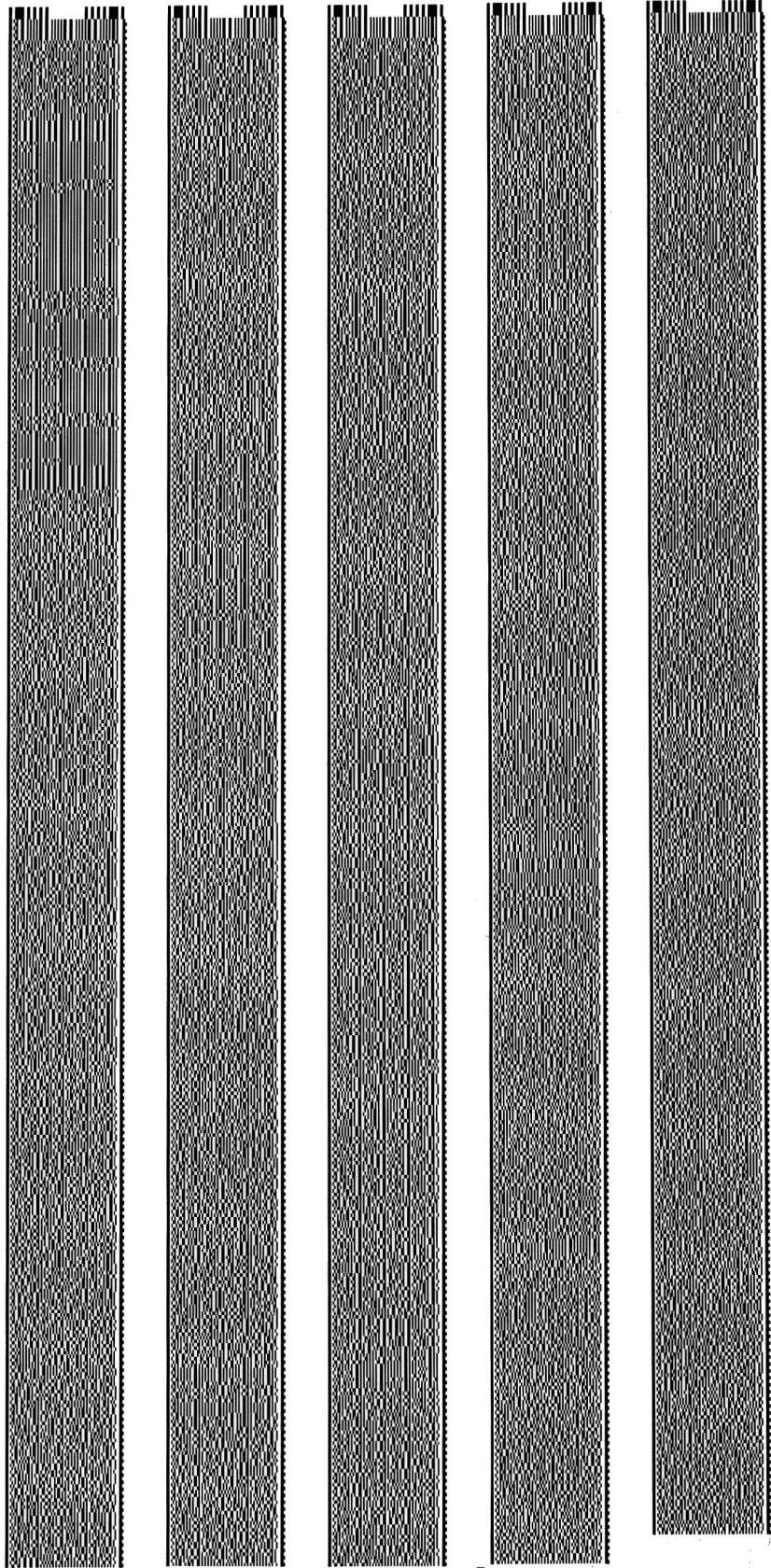

Softstrip
COMPUTER READABLE PRINT

F 1

F 2

F 3

F 4

F 5

**AND IF THAT'S NOT ENOUGH
TO START YOU STRIPPING . . .**

Do you want to create you own data strips? Well, now you can with a special StripWare program called "STRIPPER." It lets you print your disk files as strips using your own Imagewriter or Epson dot matrix printer. The printing software is only \$19.95, but just think of the things you could be stripping. Store backup files on paper. Print, copy and mail your own programs to others easily and inexpensively.

And all you need to start is the Softstrip System. You get everything you need to read strips (like the ones you're seeing in this magazine and others) for just \$199.95.

The CAUZIN SOFTSTRIP SYSTEM. It's what Apple owners everywhere are talking about. So what are you waiting for? Shouldn't you be stripping too?

For the Softstrip System Dealer nearest you (or if there isn't one in your area, to order), call toll free:

1-800-533-7323
(in Connecticut,
203-573-0150)

Softstrip
COMPUTER READABLE PRINT

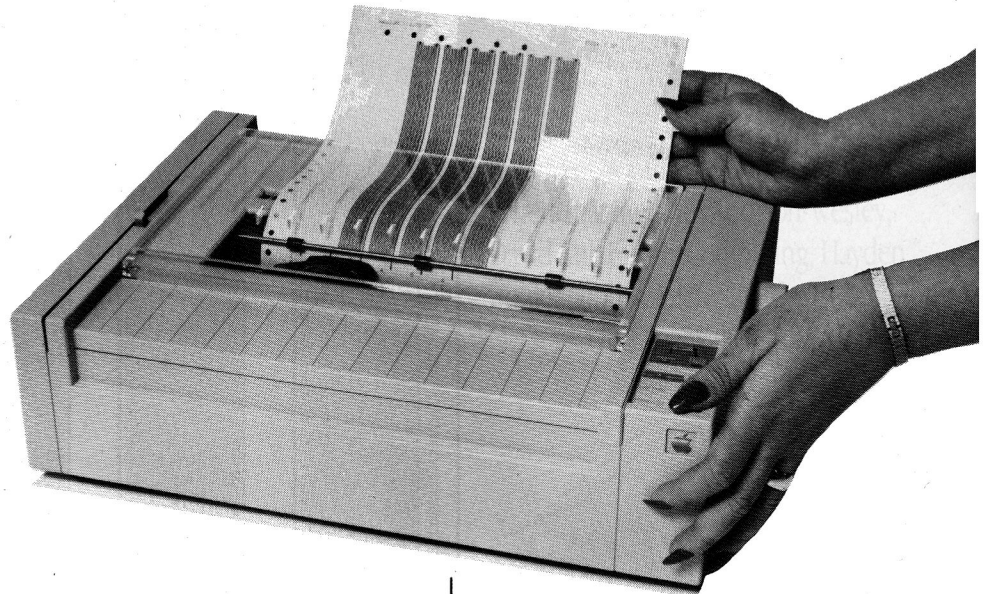

Epson is a registered trademark of Epson America, Inc. StripWare and Softstrip are trademarks of Cauzin Systems, Inc. Apple, Imagewriter, ImageWriter II, and Super Serial Card are registered trademarks of Apple Computer, Inc.

HOW TO STRIP

It's easy to read strips.

- 1) Just load Cauzin's communications software into your Apple.
- 2) Pick up the reader and lay it on the strip.
- 3) To the side of the data strip you'll see a black dot and a short black line (such as the ones found on these pages). These are your alignment marks.

- 4) Just press a single key command and then RETURN to "Read Strip".
- 5) That's all you have to do. The strip is read automatically, and its contents are saved to disk. You can use the program in the same way as if it had come on disk originally.

NOW YOU CAN PRINT YOUR OWN STRIPS!

"STRIPPER"

It's the make-it-yourself Softstrip™ data strip program. STRIPPER software lets you strip your disk files onto paper. Put up to 800 bytes on each strip and up to 7 strips on each page. And, if you use a good copier, duplicate the strips you've made.

REQUIRES:

- The Cauzin Softstrip System Reader
- Apple II, Apple II Plus, Apple //e or Apple //c
- Apple Imagewriter or Epson FX or RX printer
- Printer interface card: either a Super Serial Card (built into the Apple //c), Grappler graphics card, or Dumping graphics card

**ONLY
19.95**

**NOT PHOTOCOPY
PROTECTED**

Circle 233 on Reader Service Card.

Grappler is a registered trademark of Orange Micro, Inc.
Dumping is a registered trademark of Microtek, Inc.

H 1 |

H 2 |

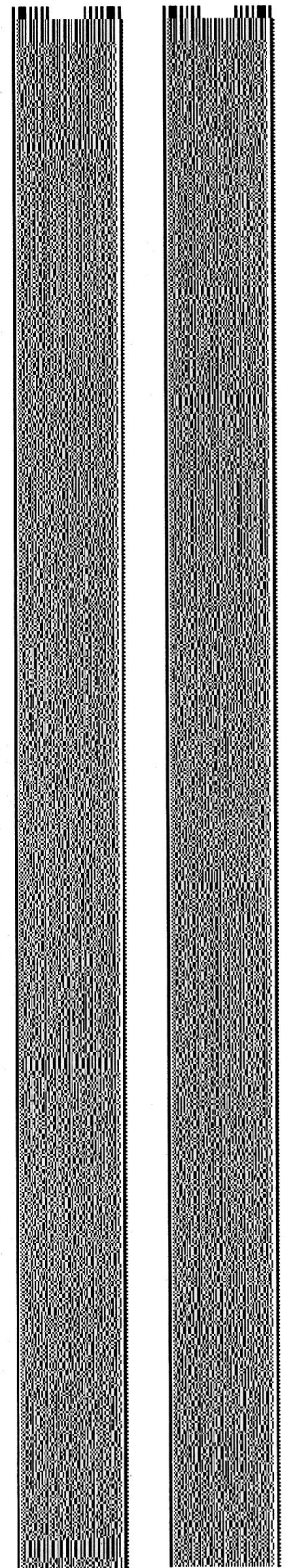

**AVOID THE CROWDS
AND THE LAST MINUTE RUSH
AND PLACE YOUR ORDER**

**SPRING IS JUST AROUND
THE CORNER!**

NOW!!

**FREE SOFTWARE—For
A Limited Time Only!!!!**

Yes, that's right. We will give you a "KNOW YOUR APPLE" program absolutely free with any size purchase. This offer is good until quantities run out, so order now and get your free software program today

WE KNOW OF NO BETTER DRIVE AT ANY PRICE!!!!!!

..... **Another Incredible PICO Product**
Look at this great half-height 100% APPLE compatible disk drive. Suggested List Price \$269.95. Instant Software priced at only **\$189.95**.

The benefits of owning this drive to you are:

- Faster, more precise tracking and larger capacity than standard Apple drives.
- Quieter and smoother running.
- 100% Apple compatibility for II+, IIe, and IIc external drives.
- Half-Height, compact design . . . saves you space.
- ONE YEAR WARRANTY.
- 30 day moneyback guarantee.



Disks 5 1/4"	List	Sale
Sentinel DS/DD COLOR 10/box	39.95	19.95 <input type="checkbox"/>
Ultra Magnetics BONUS Pack DS/DD 12/box	39.95	22.90 <input type="checkbox"/>
CDC SS/DD 10/box	31.95	9.95 <input type="checkbox"/>
CDC DS/DD 10/box	39.95	10.95 <input type="checkbox"/>
Data Matrix 10/box	44.91	11.95 <input type="checkbox"/>
Dysan DS/DD 10/box	49.95	33.95 <input type="checkbox"/>



Monitors	List	Sale
Sanyo DMC 5500 Color Composite	359.00	229.95 <input type="checkbox"/>
Sanyo DM2112 Green	118.00	79.95 <input type="checkbox"/>
Sanyo DM2112 Amber	118.00	79.95 <input type="checkbox"/>

Software

SUCH A DEAL BARGAINS
All Titles only **\$9.99**

Software	List	Sale
Adventureland		
Apple Clinic		
World Scrambler		
Caverns of Callisto		
Skybombers 11		
Capitalization		
Santa Paravia		
Voodoo Castle		
Ghost Town		
Oil Tycoon		
Electronic Breadboard		
Mortons Fork		
Mystery Fun House		
Savage Island		
The Russian Disk		
Algebra II		
Acey Ducey		
Merlin		
Routine Machine		

	List	Sale
Datarack Head Cleaning Kit	15.95	12.95 <input type="checkbox"/>
Head Cleaning Kit (c2017)	16.99	7.95 <input type="checkbox"/>
Datamatrix Head Cleaner	6.99	4.95 <input type="checkbox"/>
Anti-Static Spray Texwipe	5.95	4.95 <input type="checkbox"/>
Checkmate Anti Static	3.88	2.95 <input type="checkbox"/>
Disk Pac 3 1/2" Blue and Black	14.95	7.95 <input type="checkbox"/>
Disk Pac 5 1/4" Blue and Black	13.95	6.99 <input type="checkbox"/>
Disk File (6)	2.95	.99 <input type="checkbox"/>
Teak Rolltop Disk Storage (5 1/4" holds 50)	32.95	18.95 <input type="checkbox"/>
Teak Rolltop Disk Storage (3.5 holds 45)	23.95	14.95 <input type="checkbox"/>
Data Defender 70 (5 1/4" holds 70)	26.95	14.95 <input type="checkbox"/>
Data Defender 15 (5 1/4" holds 15)	4.49	2.99 <input type="checkbox"/>
Flip 'n' File 50 (5 1/4" holds 50)	19.95	9.99 <input type="checkbox"/>
Cassette Storage (6) Black and Blue	4.99	.99 <input type="checkbox"/>

We know of no better disks at any price. DOLLAR DISKS!!!

- Quality Sentinel brand 5 1/4" disks
- Reliable, lifetime warranty
- SS/DD only \$1.00 each
- DS/DD only \$1.15 each
- Any quantity

Brother HR-10 Daisy Wheel Printer FINALLY! A Letter Quality Printer at a PRICE you can AFFORD

List price 349.00 **YOUR LOW PRICE ONLY \$299.00***

The HR-10 is designed to keep pace with modern computing needs by producing sharp, beautiful letter quality text. Thanks to a 2k bytes buffer and bidirectional printing, HR-10 gets everything onto the page quickly and accurately. The sprocket wheel feeder TF-10, which keeps fanfold paper flowing smoothly and efficiently, is standard equipment. And a shadow print feature lets you highlight words or phrases so they stand out from the rest of the text. Other features such as superscript and subscript, auto-underline and carriage skip movement provide versatility usually found on more expensive models.

	List	OUR LOW PRICE*
Brother HR-15 Letter Quality	599.00	349.00 <input type="checkbox"/>
Olympia-RO Letter Quality	429.00	289.95 <input type="checkbox"/>
Epson Homewriter		
Dot Matrix	269.00	219.95 <input type="checkbox"/>
Epson LX-80 NLQ		
Dot Matrix-NLQ	299.00	249.95 <input type="checkbox"/>
Epson FX100		
Dot Matrix	849.00	549.95 <input type="checkbox"/>

MORE Items at fantastic SAVINGS . . .

	List	Our Price
Cut Throat	39.95	24.95 <input type="checkbox"/>
Enchanter	39.95	24.95 <input type="checkbox"/>
Bank Street Writer	69.96	39.95 <input type="checkbox"/>
All Keyfax Products	12.95	5.95 <input type="checkbox"/>
Prodos		
Multiplan		
Applewriter IIe		
Visicalc		
Keyboard cover	9.95	4.95 <input type="checkbox"/>
Bank Street Storybook	39.95	24.95 <input type="checkbox"/>
Microzine for Apple IIe	39.95	13.95 <input type="checkbox"/>
Archon	40.00	24.95 <input type="checkbox"/>
Cut & Paste	35.00	14.95 <input type="checkbox"/>
Financial Cookbook	35.00	29.95 <input type="checkbox"/>
Desecration	37.95	9.95 <input type="checkbox"/>

The Last Gladiator	35.00	9.95 <input type="checkbox"/>
Basic Tricks for the Apple	24.95	13.95 <input type="checkbox"/>
Learn Apple Logo	19.95	14.95 <input type="checkbox"/>
Night Flight	24.95	19.95 <input type="checkbox"/>
HARD FAT MACK	35.00	12.95 <input type="checkbox"/>
Sky Fox	40.00	24.95 <input type="checkbox"/>
Murder on Zinderneuf	40.00	24.95 <input type="checkbox"/>
Seven Cities of Gold	40.00	24.95 <input type="checkbox"/>
Routine Machine	29.95	9.95 <input type="checkbox"/>
Merlin Apple IIe	30.95	9.95 <input type="checkbox"/>
Copycat Apple IIe	29.95	10.95 <input type="checkbox"/>
Sampler 1	29.95	11.95 <input type="checkbox"/>
Array	29.95	11.95 <input type="checkbox"/>

Pico Products		
Joysticks for ALL Apples	39.95	21.95 <input type="checkbox"/>

Modems

	List	Our Price
Anchor Mark x	159.95	99.95 <input type="checkbox"/>
Anchor Volksmodem	72.68	49.95 <input type="checkbox"/>
Black Jack	49.95	25.95 <input type="checkbox"/>

GLARE GUARDS FOR YOUR CRT

These screens are available for color or mono (please specify).

- Fine nylon mesh•Easy attachment with velcro strips
- Reversible black or cream color•prevents dust accumulation

Only 19.95 for 12" and 24.95 for 14"

Universal Joystick from PICO PRODUCTS

This great joystick will work with an Apple II, II+, IIe or IIc and comes complete with:

- 2 operating modes to give you "Auto-Centering" or "FreeFloating."
- 2 pairs of fire buttons for the left or right-hand user.
- New quick fire button!

•ONE YEAR WARRANTY, 30-day money back guarantee.
•Easy to use and extremely durable. List 39.95 Sale **21.95**

Protect Your Software FLIP 'N' FILE /15

Protect Software from dust, debris and moisture. Stores up to 15 5 1/4 diskettes.

List Price \$9.95 Sale **\$7.95**

Also Available

	LIST	SALE
Flip 'n' File /50	\$19.95	\$14.95 <input type="checkbox"/>
Data Defender /35	\$ 9.95	\$ 7.95 <input type="checkbox"/>
Data Defender /70	\$26.95	\$19.95 <input type="checkbox"/>
Roll Top /100	\$49.95	\$39.95 <input type="checkbox"/>

Kill Spikes, Fight Surge! MAXI Strip

Protect Valuable electronic equipment and data files from damage. Surge and spike suppressor and noise combination converts one outlet into six.

List \$34.95 **WOW!!!** only **\$19.95**

Also save on surge suppressors by CURTIS...

	List	SALE
Diamond	\$49.95	\$39.95 <input type="checkbox"/>
Emerald	\$59.95	\$49.95 <input type="checkbox"/>
Sapphire	\$79.95	\$69.96 <input type="checkbox"/>
Ruby	\$89.95	\$79.95 <input type="checkbox"/>

FAN FOLD COMPUTER PAPER

	LIST	SALE
15# 1000 Sheets	\$14.96	\$ 9.95 <input type="checkbox"/>
20# 1000 Sheets	\$19.95	\$14.95 <input type="checkbox"/>
20# 1000 Sheets micro-perfed	\$19.95	\$14.95 <input type="checkbox"/>
20# 2500 Sheets	\$32.95	\$26.95 <input type="checkbox"/>

instant Software
computer centers

CALL TOLL FREE 800-843-6700

or call our BBS
603-357-4306 operator 1105 (N.H.—603-352-3736)

Some quantities limited. Selection may vary.

or clip and mail coupon to Instant Software, WGE Center/70 Rte 202N, Peterborough, NH 03458
MC, VISA, M.O. or check accepted. Add \$3.00 for shipping and handling.

*call for shipping charges

Name _____
Address _____
City _____ State _____ Zip _____

Continued from p. 52.

use your computer as an adjunct to your stationary bicycle or rowing machine.

Make Mine Caffeine

Besides diet and exercise, drugs influence our psychophysical well-being. In the area of substance-abuse education, as in other areas of education, the Apple shines. At least three publishers offer programs to help you deal with your own or your children's concerns about drugs, including alcohol and tobacco.

Marshware offers two programs—**Alcohol: The Party** and **Tobacco: To Smoke or Not to Smoke**. Both programs include tutorials about the dangers of these drugs and simulations in which you take an active role.

In **Alcohol**, you attend a party and make decisions about drinking and driving. During the party, the computer displays a graph of your simulated blood-alcohol level. You get to play a rigged video game with the same klutzy lack of coordination you would experience if you were "under the influence."

In **Tobacco**, you make decisions about smoking for a hypothetical friend. You follow his or her life from youth to old age. You share in disappointments over losing friends, being ousted from the swimming team, and becoming ill.

From Sunburst Communications, you learn startling statistics about tobacco in its program, **The Smoking Decision**. Instead of deciding for a make-believe friend, you decide for yourself. Like another wellness program, **Make It Click: Seatbelt Safety**, **The Smoking Decision** is designed for school children but can easily be used at home.

Alcohol/Drug Abuse, a program developed by the Parents' Resource Institute for Drug Education (PRIDE) in Atlanta, is a fact-filled computerized reference guide. More than two dozen commonly abused drugs are described. This educational, even shocking, program contains a special section on marijuana and a listing of drug hotline numbers. A spokesperson for the publisher claims that the program is for young people, but adds, "Many of us grew up before the drug culture [evolved] but need to be prepared to deal with it."

Arghhh!

Maybe you're one of the lucky ones. Your body's in shape, you eat right, exercise. Your kids are straight-A, prefer milk to Pepsi, and Mozart to rock videos. Sure.

We don't need experts to tell us that we all experience stress, some of it good, some of it deadly. Your Apple probably can't help you avoid stress. In fact, feverishly working with a computerized tax-return program or losing an important data base would likely add stress to your life.

Your computer, though, may be able to help you deal with stress more effectively. Three companies provide stress-reduction programs for the Apple II. All include hardware as well as software, all cost at least \$100, and all center around some aspect of biofeedback, a method in which you become attuned to your body's usually unrecognized responses to stress.

The physiology of stress is complicated and subtle. Stress responses are mediated by hormones from the brain and from the adrenal glands that sit on top of the kidneys. In a research laboratory, using animal models

With Z-80 Plus,TM run CP/M[®]—the largest body of software in existence.

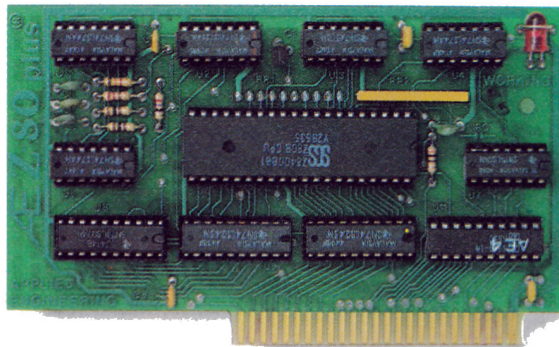

*Now, get two computers in one,
and all the advantages of both.*

Enter the CP/M world with the new Z-80 Plus card from Applied Engineering, and introduce your Apple IIe[®] or II + [®] to the thousands of CP/M programs. Only the Z-80 Plus comes standard with the new 4.0 software, the most advanced system ever for running CP/M programs.

The new 4.0 boasts advanced features like built-in disk emulation for popular memory expansion boards, boosting both system speed and storage capacity. And menu-driven utilities that let you get to work faster. The Z-80 Plus also lets you run older CP/M programs — all the way down to Version 1.6 (2.2 is the most popular).

The Z-80 Plus is the only card on the market capable of accessing more than 64K in an Apple IIe. If you have an extended 80-column card, all 128K is usable, and if you have RamWorks, up to 1088K is available.

Each Z-80 Plus comes with our CP/M Ram Drive software, enabling IIe owners to use an extended 80-column card or a RamWorks card as a high-speed Ram disk which runs CP/M software up to *twenty times faster*. So packages like WordStar and dBASE II run at blinding speed.

Simply plug the Z-80 Plus into any slot in your Apple. You'll get the benefits of two computers in one — all at an unbelievably low price (only \$139!).

- Fully compatible with ALL CP/M software
- Fully compatible with most hard disks, including Corvus and the Sider
- Fully compatible with Microsoft disks (no pre-boot required)
- Specifically designed for high speed operation in the Apple IIe (runs just as fast in the Apple II + and Franklin)
- Runs WordStar, dBASE II, Turbo Pascal, Fortran-80, Peachtree and ALL other CP/M software with *no pre-boot*
- Semi-custom I.C. and low parts count allows Z-80 Plus to fly through CP/M programs with extremely low power consumption (we use the Z-80B)
- Does EVERYTHING other Z-80 boards do, *plus* Z-80 interrupts
- Five year warranty

Call to order today, 9 a.m. to 11 p.m. seven days, or send check or money order to Applied Engineering. MasterCard, VISA and C.O.D. welcome. Texas residents add 5½% sales tax. Add \$10.00 outside U.S.A.

AE Applied Engineering
P.O. Box 798, Carrollton, TX 75006
(214) 241-6060

Flight Simulator II

For Apple II+,
Apple IIe, & Apple IIc

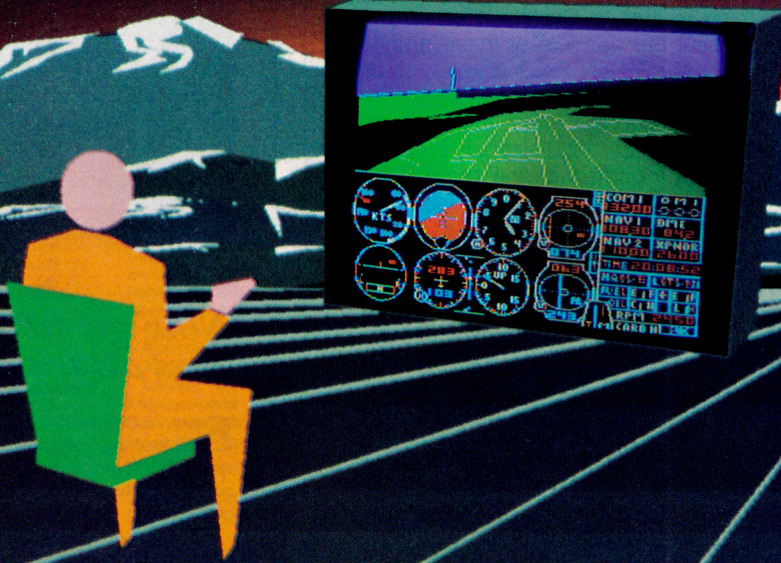

Put yourself in the pilot's seat of a Piper 181 Cherokee Archer for an awe-inspiring flight over realistic scenery from New York to Los Angeles. High speed color-filled 3D graphics will give you a beautiful panoramic view as you practice takeoffs, landings, and aerobatics. Complete documentation will get you airborne quickly even if you've never flown before. When you think you're ready, you can play the World War I Ace aerial battle game. Flight Simulator II features include ■ animated color 3D graphics ■ day, dusk, and night flying modes ■ over 80 airports in four scenery areas: New York, Chicago, Los Angeles, Seattle, with additional scenery areas available ■ user-variable weather, from clear blue skies to grey cloudy conditions ■ complete flight instrumentation ■ VOR, ILS, ADF, and DME radio equipped ■ navigation facilities and course plotting ■ World War I Ace aerial battle game ■ complete information manual and flight handbook.

See your dealer . . .

or write or call for more information. For direct orders enclose \$49.95 plus \$2.00 for shipping and specify UPS or first class mail delivery. American Express, Diner's Club, MasterCard, and Visa accepted.

Order Line: 800 / 637-4983

subLOGIC
Corporation
713 Edgebrook Drive
Champaign IL 61820
(217) 359-8482 Telex: 206995

Circle 156 on Reader Service Card.

Can Intelligence Be Artificial?

When you first hear the term artificial intelligence (AI), you may think of Big Brother, that omnipresent villain in Orwell's 1984. In reality, AI represents a powerful, and somewhat overrated, trend in software development.

AI programs (or expert systems, as they're sometimes called) can be designed for nearly any area of human endeavor. Right now, however, AI software for personal computers seems to be limited to the area of interpersonal relations.

In the Apple II software line, for all practical purposes, Human Edge Software Corporation is AI. Human Edge is the publisher of Mind Prober and Mind over Minors, two home products described in the accompanying article.

Human Edge also offers high-end (read: expensive) AI programs in its **Business Strategy Software** series: **The Communications Edge, The Sales Edge, The Management Edge, and The Negotiation Edge.**

All of these programs are based on extensive research in human relations and psychology. They operate in a simple, straightforward fashion. When you first use any of the Human Edge business-psychology programs, you profile yourself by responding in an affirmative or negative fashion to statements like "A strong defense is necessary for America's survival," or "I have more energy than others at work."

Next you profile your colleague, client, customer, or subordinate by agreeing or disagreeing with adjectives the program presents to describe the person you have in mind. There's no room for doubt, no allowance for shades of gray. You either agree or disagree with such terms as Concerned, Affiliative, or Afraid.

Once the profiles are complete, the program generates a three- to ten-page report highlighting ways in which you should interact to communicate, sell, manage, or negotiate.

While you may not dispute the research that serves as a basis for Business Strategy Software, you may wonder how you can effectively "read" people you may not know very well. Some qualities ("flashy") may be easy to discern. But how do you tell if a customer is "obedient," "innovative," or "aspiring"? Sometimes all you can do is guess. □

—C.E.F.

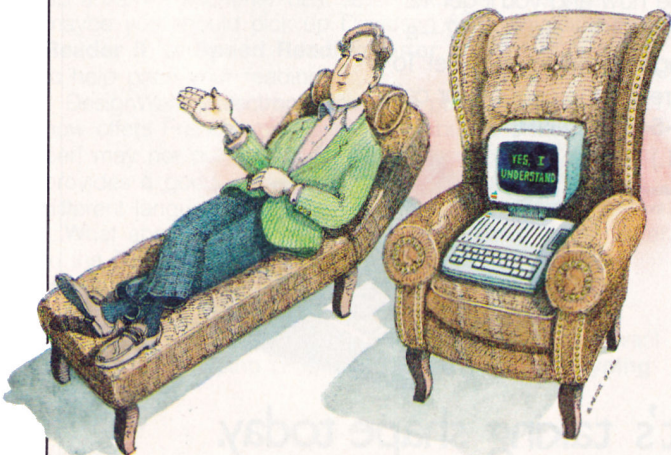

Viewmaster 80™ the sharpest 80 column card of them all.

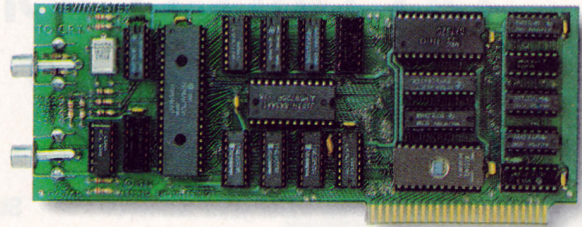

	BUILD-IN SOFTWARE	SHIFT KEY SUPPORT	LOW POWER DESIGN	80 COLUMN ROMS	7x9 DOT MATRIX	LIGHT PEN INPUTS	80 COLUMN OPERAND	INVERSE CHARACTERS
VIEWMASTER 80	✓	✓	✓	✓	✓	✓	✓	✓
SUPRTERM		✓					✓	✓
WIZARD 80					✓		✓	✓
VISION 80	✓	✓			✓			
OMNIVISION		✓				✓	✓	
VIEWMAX 80	✓				✓			
SMARTERM	✓	✓			✓	✓	✓	
VIDEOTERM		✓	✓		✓	✓	✓	✓

Now, get great resolution and total software compatibility for your Apple II® or II+®

One look at the chart will give you some of the reasons there's only one smart choice in 80 column cards for your Apple. But the real secret to Viewmaster 80's success is something even better: Total compatibility.

The Viewmaster 80 works with all 80 column applications, including DOS 3.3, PRO-DOS, CP/M, Pascal, WordStar, Format II, Easywriter, Applewriter II, Supertext 80, Zardax, Apple PI, Letter Perfect, dBASE II, Visicalc, Multiplan, and *hundreds* of others.

And the Viewmaster 80 delivers a super sharp, state-of-the-art display with a 7x9 character matrix for clear, easily readable characters. Here are just a few of the powerful features the Viewmaster 80 delivers for a great price (\$139):

- 80 Characters by 24 lines
- Fully compatible with all Apple languages and software
- Super sharp 7x9 character matrix with true descenders
- Highest compatibility with existing 80 column software
- Power and input connector for light pen
- Very low power consumption
- High speed (18 MHz) scroll rate
- Upper and lower case characters with true descenders, both inverse and normal; all on-screen editing functions are supported
- User-definable cursor shape
- Compatible with Apple II, II+ and IIe
- Five year warranty

Call to order today, 9 a.m. to 11 p.m. seven days, or send check or money order to Applied Engineering. MasterCard, VISA and C.O.D. welcome. Texas residents add 5½% sales tax. Add \$10.00 outside U.S.A.

AE Applied Engineering
P.O. Box 798, Carrollton, TX 75006
(214) 241-6060

Are you prepared for tomorrow?

inCider knows that your world of computing is as ever-changing as the lifestyles of the '80s. What's "in" today may be "out" tomorrow. And if you're an Apple II* user, not being ready for tomorrow's changes and challenges can mean less productivity and efficiency.

That's why an *inCider* subscription can be the best investment you make for all your tomorrows. The "Apple II Journal" will keep you informed about every current event, as well as ideas that are still on the drawing board.

Yes. I want to be a well-informed Apple II user! Please send me 12 issues of *inCider* for \$24.97. I'll save 30% off the newsstand price.

Payment enclosed Bill me

Name _____

Address _____

City _____ State _____ Zip _____

Canada and Mexico \$27.97, 1 year only, US funds drawn on US bank. Foreign surface \$44.97, 1 year only, US funds drawn on US bank. Foreign airmail, please inquire. Please allow 6-8 weeks for delivery.

inCider, P.O. Box 911, Farmingdale, NY 11737 365B5

Stay On Top Of The Trends

And to know what's hot and what's not, you need to **Ask *inCider***—the popular monthly feature that answers your questions about the latest software and the newest programming ideas.

Hardware? In **Apple Clinic**, you'll learn what works best for other Apple users, plus you'll discover some very economical maintenance and repair hints.

Then, take a look at **Applesoft Adviser**. In no time, you'll become a natural with BASIC so that you can be a better and more creative programmer.

And that's just the beginning of what's in every *inCider* every month.

The Progressive "Apple II Journal"

inCider is today's Apple II magazine dedicated to meeting the challenges you'll face tomorrow. Even our new look sports a cleaner, more appealing design for easier reading and reference!

Subscribe now and you'll get 12 issues of *inCider* for just \$24.97—a **30% savings** off the cover price! To order, just return the coupon, or call **1-800-258-5473**. (In NH, call 1-924-9471.)

* Apple II is a registered trademark of Apple Computer, Inc.



inCider

Showing you the future that's taking shape today.

and appropriate instrumentation, an Apple computer could monitor the effects of stress directly.

At home, it isn't practical to dissect oneself or insert probes into the brain or adrenal glands. It is practical to use noninvasive types of measurements. This indirect approach is precisely the method used in **Biofeedback Microlab**, **Relax!**, and **Learning to Cope with Pressure**.

Biofeedback Microlab measures four types of feedback: muscle tension, sweat-gland activity, skin temperature, and heart rate. The sensors you need to monitor all four responses accompany the software, which graphs and displays your progress on screen.

Like Biofeedback Microlab, the Relax! program includes an interface box that serves as a go-between to connect the special headband that comes with the program to the Apple. Unlike Biofeedback Microlab, however, Relax! concentrates on muscle tension only. A cassette tape contains a relaxation exercise you listen to while you observe the real-time Relax Graph on your monitor screen. The software also includes a Balloon Game in which you perform better if you're more at ease. Quite a change from games in which your blood pressure seems to rise in direct proportion to your score!

Instead of measuring muscle tension, Learning to Cope with Pressure monitors galvanic skin resistance (GSR), an indicator of sweat-gland activity. You rest your hand on the GSR biosensor, which connects by cable to the game port.

The software includes a Physical Stress Test and a Psychological Stress Test as well as three methods for managing stress. A cassette tape included with the program offers a brief monologue on biofeedback and an oh-so-mellow relaxation exercise.

Because Learning to Cope with Pressure is sold primarily to schools, it includes lesson plans and classroom activities. With a little imagination, you could modify these for family use.

Skill Builders

Whatever the cause and extent of stress in your life, healthy escapes can help you cope. Losing yourself in a good novel can rejuvenate you. So can learning a new language, or finally accepting the challenge of learning to type using the Qwerty or Dvorak method instead of the Columbus method.

All of these relaxing activities involve skills your Apple can help you attain. If you find yourself hesitating to pick up a James Michener best seller because of its size, maybe you should pick up Davidson & Associates' **Speed Reader II**, or **Speed Reading Tutor** from Kriya Systems, to help pace your reading.

DesignWare's electronic flashcard program, **Remember!**, now offers French and Spanish vocabulary disks. Remember! may not put Berlitz out of business, but the program provides a good start for people who would like to learn different languages.

What about that letter you owe Aunt Alice? Or the Letter to the Editor you've been meaning to write? If only it didn't take so long to hunt and peck at the keyboard!

Not only can your Apple process your words, it can teach you how to type them in the first place. If you want a by-the-book typing program (with video game), **Typing**

Timemaster H.O.[™] the only clock that displays time and date on AppleWorks[™] screens and files.

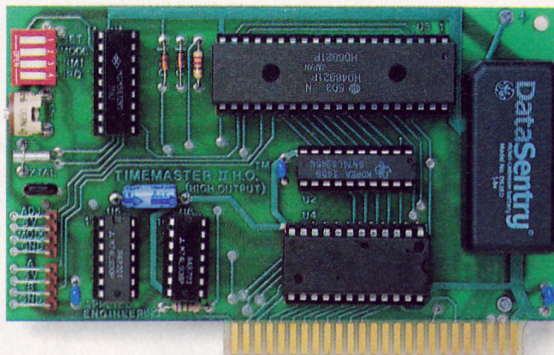

*Now, get all the features of
all the competition combined!*

It's the smart way to put the time and date on your Apple II+[®] or IIe[®]. Because only the Timemaster H.O. packs ALL the features of all the competition *combined*, including leap year, year (not just in PRO-DOS), month, date, day of week, hours, minutes, seconds and milliseconds. It's totally PRO-DOS, DOS 3.3, PASCAL and CP/M compatible. And of course, it works better than any other clock with AppleWorks.

If you're using or writing software for other clock cards, you're still covered. Because the H.O. will *automatically* emulate them. And the Timemaster H.O. adds 14 new commands to BASIC. The H.O. even comes complete with two disks full of sample programs, including a computerized appointment book, a DOS dating program, interrupt programs, and over 30 programs that others charge extra for — or don't even offer.

As a low-cost option, you can add true BSR remote control to the H.O., giving you remote control of up to 16 lights and appliances in your home or office.

- Fully PRO-DOS and DOS 3.3, CP/M and PASCAL compatible
- Time in hours, minutes, seconds and milliseconds (the ONLY PRO-DOS compatible card with millisecond capability); date with year, month, day of week and leap year
- 24-Hour military format or 12-hour AM/PM format
- Eight software controlled interrupts so you can run two programs at the same time (many examples included)
- Can be set to the second
- Allows AppleWorks to time and date stamp all data automatically
- The only clock card that displays time and date on the AppleWorks screen
- Five-year warranty

Clock price \$129.00
BSR option (may be added later) \$ 49.00

Call to order today, 9 a.m. to 11 p.m. seven days, or send check or money order to Applied Engineering. MasterCard, VISA and C.O.D. welcome. Texas residents add 5½% sales tax. Add \$10.00 outside U.S.A.

AE Applied Engineering
P.O. Box 798, Carrollton, TX 75006
(214) 241-6060

Tutor III may be the best. If a little out-of-this-world entertainment is in order, either **New Improved MasterType** or **Keyboard Cadet** should suffice.

If variety of exercise, including typing-practice variants of PacMan and Gunsmoke, is what you desire, take a look at **Typing Well**. All four of these programs will teach you correct finger placement and provide hours of fun and satisfaction.

Getting to Know You

Our physical, mental, and emotional health depends on our relationships with people, past and present.

Alex Haley showed us through his book, *Roots*, that who we are is keenly influenced by those who came before us. A software program for your Apple called **Family Roots** can help you learn more about your ancestors.

The program has other interesting applications. One New York physician is using Family Roots to keep track of data accumulated in his study of the genetic aspects of cystic fibrosis.

Acclaimed by genealogists, Family Roots keeps track of names, dates, birthplaces, and myriad other details, including anecdotes. The program prints a variety of charts to help you sort out the folks who helped make you the person you are.

But what about your contemporary relationships? Software to help you in this area presents a strange mix. On

the one hand, **Mind over Minors**, from Human Edge Software, assists you in dealing with your children or students. This program shows how your personalities mesh, or fail to.

Mind over Minors asks you to agree or disagree with a series of adjectives about you. You profile your young person the same way. The program then prepares an analysis explaining how you can interact, motivate, and discipline. (For a look at business-psychology software, see the accompanying sidebar.)

On the other hand, Activision's **Alter Ego** is a game in which you play "what if" and watch your imagined life unfold on the screen. You participate in numerous vignettes and make choices from infancy through old age—if you make it that far.

When I played Alter Ego, I was an arrogant fool who ignored the stress in my life. The program chided me, "Your lack of desire to take care of yourself was selfish. Now your family and friends will have to suffer the loss. This game is over." Poof.

Then there's **Mind Prober**, a program touted as psychological software that helps you get to know other people as they are. Mind Prober works like Human Edge Software Corporation's other home-psychology program, Mind over Minors. The main difference is that in Mind Prober you profile only the other person, not yourself.

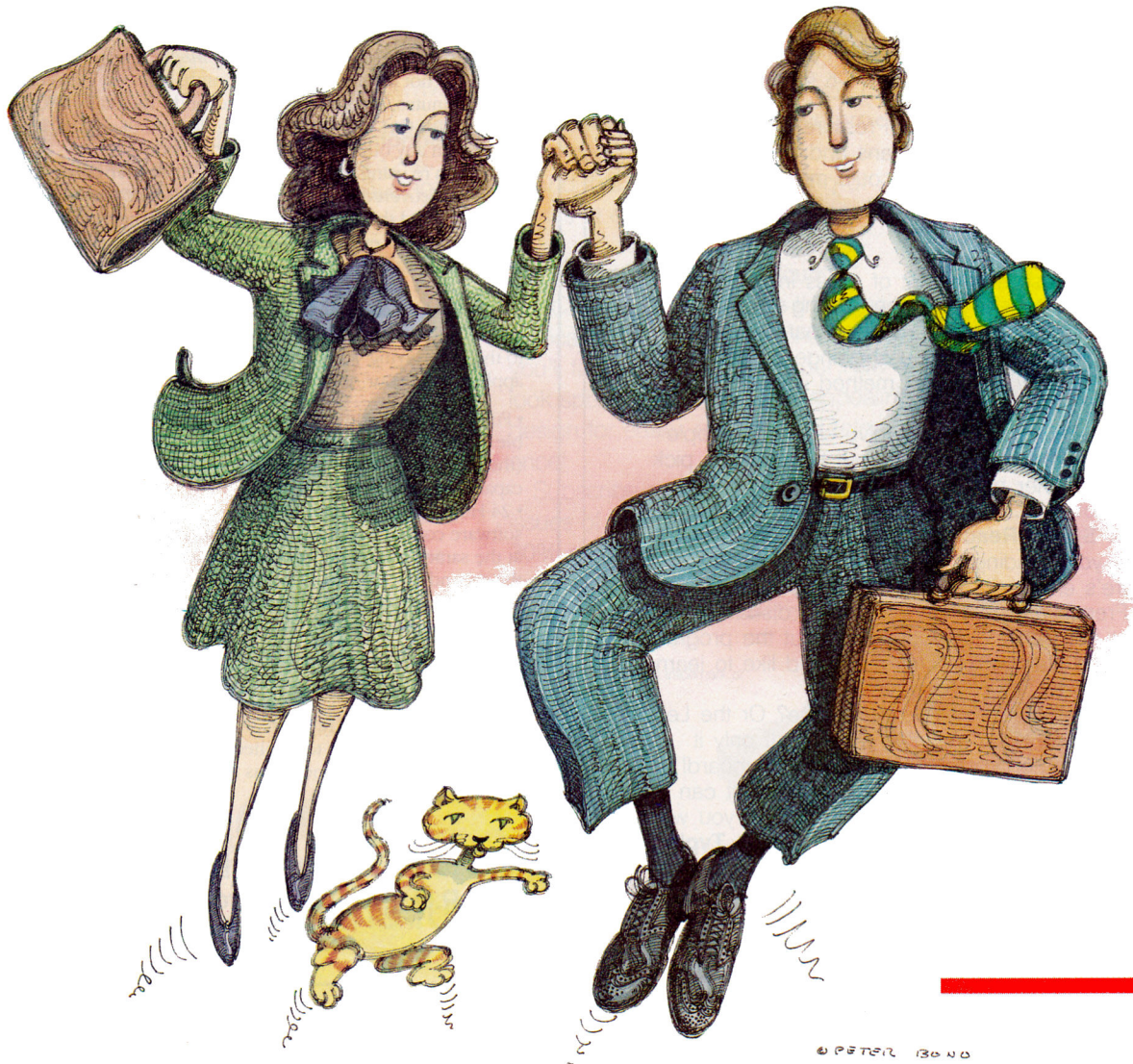

To boldly go at speeds no Apple has gone before.

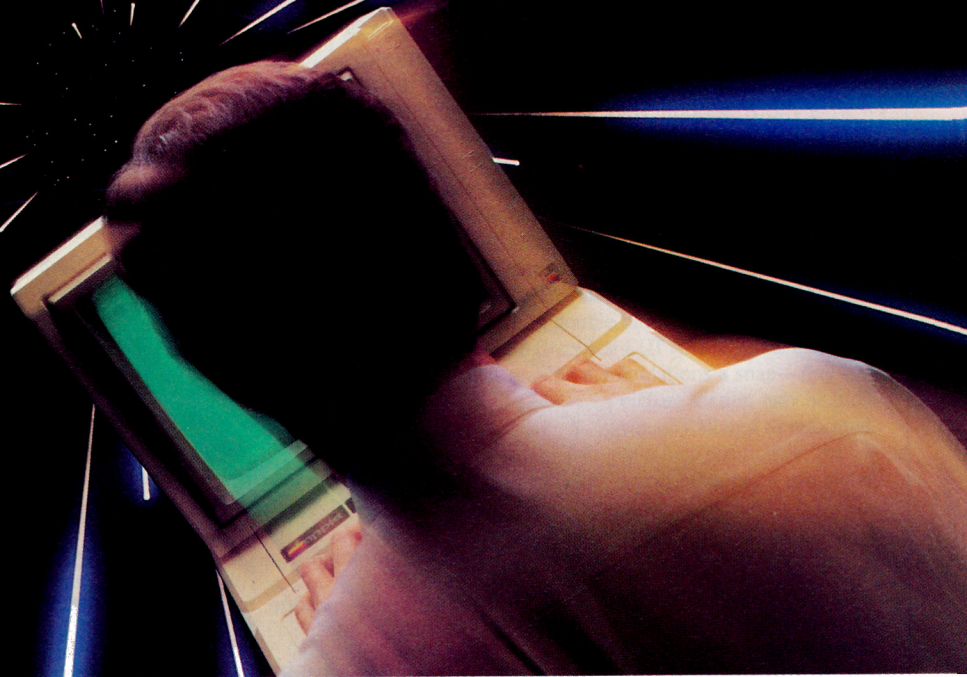

Get TransWarp™. The fastest accelerator you can buy for your Apple™ IIe, II, or II+.

Computing at warp speed!

It's an experience you shouldn't miss. And with TransWarp, you won't have to. Because TransWarp will run your software up to *3.6 times faster* — leaving other accelerators in the stardust!

No more yawning while your Apple™ slowly rearranges text or calculates spreadsheets. With 256K of ultra-fast RAM, TransWarp speeds up *all* Apple software — including AppleWorks, Supercalc 3a, Visicalc, and all educational software, graphics and games. And it's compatible with all standard peripheral cards (such as RamWorks II and Apple memory cards), Profile and Sider hard disks, 3½" UniDisks, 80-column cards, modems, clock cards, mouses and more! You name it, TransWarp accelerates it. There's even a 16 bit upgrade chip available should 16 bit software become available for the Apple.

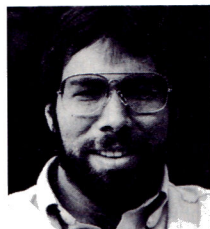

"I recommend Applied Engineering products wholeheartedly."

*Steve Wozniak, the creator
of Apple Computer*

An important difference.

TransWarp's not the only speedup card on the market. But it's the only one that accelerates your Apple's main memory, ROM *and auxiliary memory*. And with more and more programs residing in auxiliary memory, buying anyone else's accelerator makes less and less sense. TransWarp even works with most D.M.A. devices including the Swyft™ card.

There's one more difference. Since TransWarp doesn't use memory caching, it accelerates *all* software — and not just most of it.

A cinch to use.

Simply plug TransWarp into any slot in your Apple II, II+ or IIe — including slot 3 in the IIe. Instantly you'll be computing at speeds you only dreamed about before. And should you ever wish

to run at normal speed, simply press the ESC key while turning your Apple on.

Since TransWarp is completely transparent, you won't need pre-boot disks or special software. It's ready to go right out of the package!

Speed = Productivity

Imagine the productivity gains you'll achieve when your programs are running over three times faster. TransWarp is so powerful, your Apple will make IBM PCs™ and even ATs™ look like slowpokes — whether you're planning taxes, plotting charts or playing games! Take a look at a few of the features that set TransWarp apart:

- 3.6 MHZ 65C02
- 256K of ultra-fast on-board RAM
- Accelerates main *and* auxiliary memory
- Low power consumption for cool operation
- Totally transparent operation with all software
- Plugs into any slot, including slot 3 on the Apple IIe
- Accelerated 16 bit option available

Satisfaction guaranteed!

Give *your* Apple the TransWarp advantage. With our risk-free 15-day money back guarantee, you have nothing to lose but wasted time. Call today!

TransWarp Accelerator \$279
16 bit upgrade (may add later) \$89

For fast response:

Call Applied Engineering, 9 a.m. to 11 p.m., 7 days at (214) 241-6060. MasterCard, VISA and C.O.D. welcome. Texas residents add 5½% sales tax. Add \$10.00 if outside U.S.A.

Or mail check or money order to Applied Engineering, P. O. Box 798, Carrollton, TX 75006.

AE Applied Engineering
The Apple enhancement experts.

P. O. Box 798, Carrollton, TX 75006 (214) 241-6060

Mind Prober's detractors insist that the program's power is illusory because its conclusions may be based on erroneous perceptions and first impressions. To its credit, Mind Prober works best with people you already know, and it's a ton of fun to read the program's assessments of those unique characters among your family and friends.

In a more serious vein, one of the most rewarding things in life is to know someone who shares your dreams and helps you work toward your goals, whether those objectives relate to health or to wealth.

Alter Ego Development has a software surrogate for those who lack such a confidante or mentor. The developers call their program **Personal Friend**, and somewhat bizarrely refer to it as "Living Software."

Imagine! If Personal Friend is ever released in 3½-inch disk format, you'll be able to carry your "true friend" in your shirt pocket and threaten him with a magnet if he betrays you.

Humanizing a floppy disk, whether implicitly or explicitly, leaves me saddened. Your Apple can open up new vistas for you and make you a well-rounded person, but computerware, even if endowed by its "creators" with "intelligence," can't substitute for the companionship and camaraderie that only other human beings can offer. ■

Write to Cynthia Field at 10 Border Avenue, Wakefield, RI 02879.

For a look at NutraHelp, inCider's free nutrient-analysis program listing, turn to p. 94.

Product Information

Alcohol/Drug Abuse, \$39

Personal Health, \$49

RAM Resources
100 Lynn Street
Peabody, MA 01960
(617) 532-4535

Reader Service Number 303

Alcohol: The Party, \$49.95

Tobacco: To Smoke or Not to Smoke, \$49.95

Marshware
P.O. Box 8082
Shawnee Mission, KS 66208
(816) 523-1059

Reader Service Number 304

Alter Ego, \$49.95

Activision
2350 Bayshore Frontage
Road
Mountain View, CA 94039
(415) 960-0410

Reader Service Number 305

An Apple a Day, \$49.95

Architectural Design, \$99.95

Interior Design, \$69.95

Landscape Design, \$69.95

Avant-Garde Publishing
P.O. Box 30160
Eugene, OR 97403
(503) 345-3043

Reader Service Number 306

Biofeedback Microlab, \$350

Cardiovascular Fitness

Lab, \$175

HRM Software
175 Tompkins Avenue
Pleasantville, NY 10570
(800) 431-2050

Reader Service Number 307

The Communications

Edge, \$195

The Management Edge, \$250

Mind over Minors, \$59.95

Mind Prober, \$49.95

The Negotiation Edge, \$295

The Sales Edge, \$250

Human Edge Software
2445 Faber Place
Palo Alto, CA 94303
(800) 624-5227

Reader Service Number 308

Dream House, \$39.95

CBS Software
One Fawcett Place
Greenwich, CT 06836
(800) CBS-ASK4

Reader Service Number 309

Family Roots, \$185

Quinsept
P.O. Box 216
Lexington, MA 02173
(617) 641-2930

Reader Service Number 310

HouseCall '86, \$39.95

Rocky Mountain
Medical Software
5680 South Syracuse Circle,
Suite 500
Greenwood Village, CO 80111
(800) 233-3556

Reader Service Number 311

Keyboard Cadet, \$39.95

Mindscape
3444 Dundee Road
Northbrook, IL 60022
(800) 221-9884

Reader Service Number 312

Learning to Cope

with Pressure, \$99

Make It Click:

Seatbelt Safety, \$59

The Smoking Decision, \$59

Sunburst Communications
39 Washington Avenue
Pleasantville, NY 10570
(800) 431-1934

Reader Service Number 313

New Improved

MasterType, \$39.95

The Original Boston

Computer Diet, \$79.95

Scarborough Systems
25 North Broadway
Tarrytown, NY 10591
(914) 332-4545

Reader Service Number 314

Nutriplan, \$75

Micromedex
187 Gardiners Avenue
Levittown, NY 11756
(516) 735-8979

Reader Service Number 315

Personal Friend, \$69

Alter Ego Development
123 West 28th Street
New York, NY 10001
(212) 563-2311

Reader Service Number 316

Relax!, \$139.95

Synapse Software
17 Paul Drive
San Rafael, CA 94903
(415) 479-1170

Reader Service Number 317

Remember!, \$79.95

DesignWare
185 Berry Street
San Francisco, CA 94107
(800) 572-7767

Reader Service Number 318

Speed Reader II, \$69.95

Davidson & Associates
3135 Kashiwa Street
Torrance, CA 90505
(800) 556-6141

Reader Service Number 319

Speed Reading Tutor, \$89.95

Kriya Systems
6 Export Drive
Sterling, VA 22170
(703) 430-8800

Reader Service Number 320

Typing Tutor III, \$49.95

Simon & Schuster Electronic
Publications
1230 Avenue of the Americas
New York, NY 10020
(212) 245-6400

Reader Service Number 321

Typing Well, \$49.95

Learning Well
200 South Service Road
Roslyn Heights, NY 11577
(516) 621-1540

Reader Service Number 322

Weight Loss and Nutrition Center, \$79.95

ISC Consultants
14 East 4th Street
New York, NY 10012
(800) 882-3438

Reader Service Number 323

Beagle Bros Apple® Software Report

Ad Number 251

"All the News That Fits"

Spring 1986

TRIPLE-DUMP

Print any Apple image on your dot-matrix printer.

Use Triple-Dump with any Apple II and your dot matrix (graphics capable) printer to print:

- Hi-Res graphics
- Double Hi-Res graphics
- Lo-Res graphics
- Double Lo-Res graphics
- 40-Column text
- 80-Column text

Make "hard copies" of all kinds of images with absolutely no programming knowledge.

Or, if you're a programmer, use Triple-Dump's print routines in your own Applesoft programs.

Triple-Dump offers many special graphics effects options such as picture cropping, rotating and magnifying, plus the ability (on many printers) to adjust the print density.

BIG BANNERS TOO: Triple-Dump puts your printer to work making giant-letter 8½"-high signs for all occasions.

\$39.95 Unprotected, ProDOS and DOS 3.3
Compatible with any Apple II
Written by Mark Simonsen and Rob Renstrom



SHAPE MECHANIC

Hi-res shape animation and fancy hi-res typefaces

Shape Mechanic converts your hi-res drawings into "shape tables" so you can create title screens, charts and animation with Apple's built-in Draw and Xdraw commands. "List and Learn" demos on the Shape Mechanic disk teach you how to create your own hi-res programs.

HI-RES TYPE: 30 proportionally spaced hi-res screen display fonts (both large and small) are included on the Shape Mechanic disk. Each character may be redrawn as you choose.

SHADOW OUTLINE CHOMP
MODS COMPUTE SKINNY
FATSO L.E.D. EMBOSSE
Penman **BROADWAYBDW**
SQUARE 200LOO

Shape Mechanic's new "SHAPE CAPTURE" feature lets you convert a section of any normal hi-res picture into a shape table.

No fee required to use Shape Mechanic's fonts & routines in programs that you sell. Just credit Beagle Bros in your program and manual.

\$39.95 Unprotected, ProDOS and DOS 3.3
Compatible with any Apple II
Written by Bert Kersey and Mark Simonsen

MINIPIX Disk#1

200 pictures for The Print Shop™ and other graphics programs

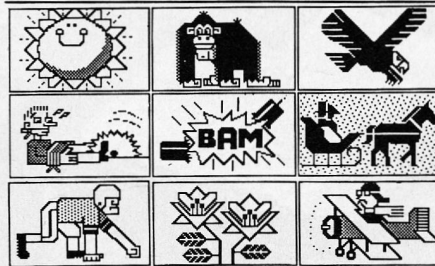

Here are 200 copyright-free pictures on disk, for you to use with the most popular Apple graphics programs, including...

- The Print Shop
- MousePaint
- Shape Mechanic
- Alpha Plot
- Apple Mechanic
- Beagle Graphics

...and almost any other Apple graphics program that deals with unprotected hi-res pictures.

Attention, PRINT SHOP owners!



Use Minipix pictures straight from the Minipix disk on your greeting cards, banners and signs. And now you can convert part of any normal hi-res picture into Print Shop format! And use Minipix's picture editor to create special graphics effects like instant mirror images, negatives, distortions and blowups:



MousePainters can load Minipix directly from the disk. Alpha Plotters can "clip" Minipix off the screen and "paste" them onto their own pictures. Shape Mechanic and Apple Mechanic fans can use Minipix in shape table format.

\$29.95 Unprotected, ProDOS and DOS 3.3
Compatible with any Apple II
Minipix pictures by Fred and Sara Crane

"The Print Shop" is a trade mark of Broderbund Software, Inc.

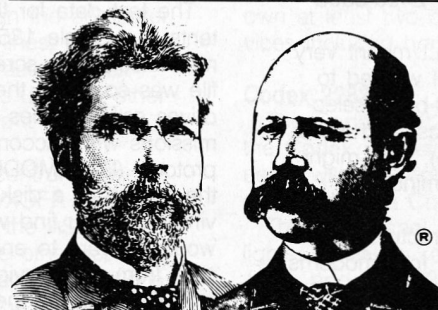

Beagle Bros
MICRO SOFTWARE

3990 OLD TOWN AVENUE
SAN DIEGO, CA 92110 PHONE 619-296-6400
BUY BEAGLE BROS DISKS AT YOUR SOFTWARE STORE.
Or Visa, MasterCard or COD, phone toll free
(orders only) 1-800-227-3800 ext. 1607

BEAGLE GRAPHICS

Double-high resolution plus 16 hi-res colors!

DOUBLE HI-RES FOR THE ARTIST...

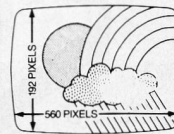

Beagle Graphics lets you use your 128K Apple to draw and label impressive double hi-res images (up to 560 pixels horizontally) using the Apple keyboard or, optionally, a joystick, AppleMouse, Koala Pad or Graphics Tablet.

And you can display 16 hi-res colors with over 200 color-mixes and fast area "color fills".

A Variety of **Typstyles** is included for labeling double hi-res pictures and charts.

Beagle Graphics' CUT AND PASTE feature makes graphic manipulations a snap—Any

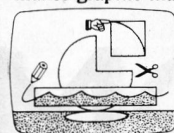

picture section may be individually altered or relocated to a new position on the screen. Or onto a completely different picture!

...OR FOR THE PROGRAMMER

You get 33 new commands for drawing, filling and manipulating double-res images. You can convert normal hi-res programs and pictures into

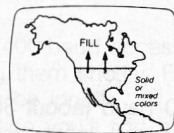

double hi-res, save and load any image section, compress picture data to 1/3 disk space, produce double hi-res "slide shows" and more.

READ THE REVIEWS: Family Computing, Feb. 86, gives its highest rating (★★★★) to Beagle Graphics in \$-Value, Graphics Quality, Documentation and Overall Performance.

\$59.95 Unprotected, ProDOS and DOS 3.3
Compatible with any Apple IIc or 128K IIe
Written by Mark Simonsen

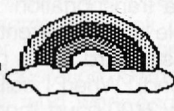

LIST
10 HGR2: CLEAR: ONERR GOTO 10
20 P=1+(P=1): POKE 49238-P,2
30 POKE 230,32*P: POKE 28,C
40 CALL-3082: POKE 49235-P,2
50 C=C+1: GOTO 20

FONT MECHANIC

30 new hi-res typefaces for Shape Mechanic (and Apple Mechanic)

Font Mechanic's fonts work with all of the programs on Shape Mechanic and Apple Mechanic:

Old English CRATE FINE
ZEBRA UNCLE BRANDING
Caesar **HOLLY WILDWOOD**
BELLS SANDWICH TIMES
U.S. OPEN EDISON
COUNTDOWN ROOSEVELT

FONT UTILITIES: Font Mechanic lets you convert fonts from other disks (DOS Tool Kit, the Penguin disks, etc.) into fonts for Shape Mechanic and Apple Mechanic.

Distort fonts too (s-t-r-e-t-c-h, COMPRESS, etc.) for hi-res copy-fitting and special effects.

\$29.95 Unprotected, ProDOS and DOS 3.3
Compatible with any Apple II
Written by Mark and Jon Simonsen

Looking for fast, reliable telecommunication? Check out inCider's sampling of high-speed modems for your Apple II, plus our selection of "no-frills" 300-baud models.

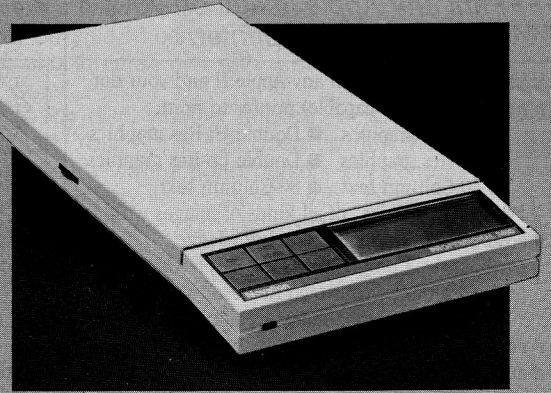
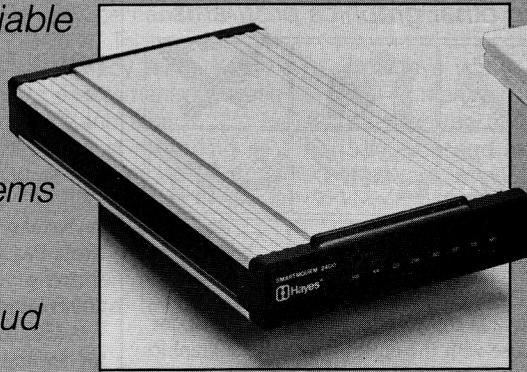

MORE BAUD

by Bill O'Brien

Communication at 300 baud (about 30 characters per second) is a time-honored, inexpensive proposition—but it's old technology and intolerably slow for some applications. In the last five years, 1200-baud modems have come to the forefront, but almost as soon as they became standard, new and faster modems appeared. We'll look specifically at what the new high-speed modems have to offer, then see what's still around in 300 baud if all you need is basic data transportation.

The fastest, most reliable speed currently available for telecommunications over standard voice phone lines is 2400 baud (bits per second). When I called several manufacturers to research their 2400-baud modems, though, I was very disturbed when they all said, "Our 2400-baud modem doesn't work with the Apple II."

I assured them that what they knew as fact meant very little to me, and I was right. The modems all worked to the same degree. In fact, although the 2400-baud selections came from Codex, Hayes, U.S. Robotics, and Novation (whose product emerged as my favorite), they might have all been the same modem—with very minor exceptions.

They all follow the Hayes AT command structure—but their compatibility goes deeper than that. All four modems have "S" command registers, and use the same registers and parameters to set the same functions.

The differences also occurred in the register area. Strict compatibility was maintained only among the first 11 registers, S0-S10, but these are the most important for setting the more common functions, such as how many rings to receive before answering. Codex supports no additional register settings, U.S. Robotics and Novation permit 15 in all, and Hayes supports 22. I'm not sure this difference is at all consequential. Some of the Hayes register commands take the place of switch settings (the 2400-baud

modem has no switches), while others perform such functions as adjusting the volume of the internal speaker.

The Test Vehicles

The 2400-baud modems evaluated in this article are the Codex Model 2282, the Hayes Smartmodem 2400, the Novation Professional 2400, and the U.S. Robotics Courier 2400. All these modems are 2400/1200/300-baud capable and were tested on an Apple IIe with enhanced video firmware. I used Softerm II as the Apple's communications program. On the other end of the line, a 512K Macintosh simulated an information service for transmission and reception of data. I also took a look at three "no-frills"-type 300-baud models: DAK Industries' Computer Infograbber modem phone, Anchor Automation's Volksmodem, and the Apple Personal Modem.

The test data for the 2400-baud modems were the contents of a single 135K file transmitted between the two machines to the screen and then a DuoDisk. Because the file was so large, the IIe was forced to access its disk drives several times during the transfers. Also, all file transmissions were accomplished without any special transfer protocol (like XMODEM). Dumping information straight to the screen or a disk drive more closely resembles the environment you find with an information service (although it would be rare to encounter a continuous 135K flow of data from any service).

At first, none of the modems worked correctly—even when slowed to 1200-baud operation. Inevitably, after 40 or 50 lines of text were transmitted to the IIe, the screen would start to scramble as characters were missed, but I expected this to happen.

When the computers were cabled directly together with no intervening modem, the scrambled screen results were the same for all speeds above 300 baud, unless XMODEM protocol was used (although the errors occurred later in the file as the speed dropped).

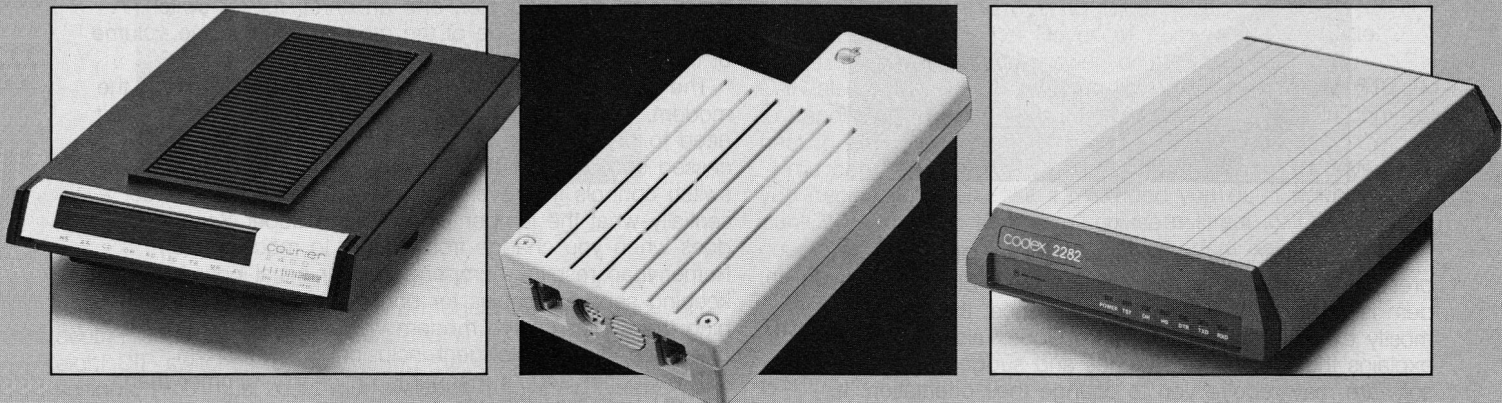

FOR THE BUCK

The reason is, of course, that certain functions like writing to the screen and accessing the disk drive take time. And they can take longer than usual on the Apple IIe. To accommodate that, communications software usually permits a secondary level of communication between machines for signaling when such time-consuming events occur. If the receiving computer is about to become busy, it sends a signal to the other machine, which asks it to wait before sending more data.

This process can take either of two forms—hardware handshaking or software control. I've yet to see a program effectively use hardware handshaking on an Apple II. At speeds below 300 baud, the Apple "standard," no control is needed at all, and few programs have ever bothered to address the issue. Above that rate, if you rely on hardware handshaking, chaos takes over the screen.

Software control is a different story. When the computer becomes too busy to monitor the RS-232 lines, the receiving computer sends a special control character to halt transmission. The originating machine waits until the other computer sends a second character before it resumes transmission.

There are several methods of software control in use: ACK/NAK, ETX/ACK, DC1/DC3, and XON/XOFF. Essentially, they all work the same way. One of the ASCII control codes stops data transmission, and the other restarts it. The tricky part is to make sure the telecommunications software on both computers understands the same method.

I used XON/XOFF and it immediately corrected the problem on the Apple IIe. (In fact, with the computers cabled together, I've run text-file transfers using that protocol at 9600 baud with no difficulty.)

Restrictions on 2400 Baud

Theoretically, there are no restrictions on using 2400 baud, but it represents a new standard. You'll discover that information services are slow to catch up. Some, like

CompuServe, have 2400-baud access numbers already. Others will be adding them shortly. For personal bulletin boards, the wait may be longer.

The primary restriction you'll find arises from the techniques the modems themselves use. There are three popular "standards" for microcomputer telecommunications work, and each depends on communication speed: Bell 103 for 300 baud, Bell 212A for 1200 baud, and V.22 bis for 2400 baud.

It's essential that the modems on each side of the dialogue use the same speed, and operate under the same standard. You'll find some maverick devices, for example, that use Bell 212B for 1200 baud, or a proprietary "standard" for 2400-baud operation. Some modems use a V.22 bis standard for 1200-baud work and ignore Bell 212A. (This is usually the result of a manufacturer wanting you to own at least two of his or her modems.) None of the devices included here falls into that category.

Codex 2282

The Codex 2282 is sold as a Macintosh product, and the Codex marketing people seem unaware that you can use it with the Apple II. (It's actually a Motorola modem sold under the Codex brand name.)

The front panel is equipped with a full array of status lights, indicating relative speed (green at 2400, red at 1200, and off at 300), connect, data transmission and reception, and TST. The test light flashes as the modem goes through a self-testing procedure when you first turn it on and continues until you send it any AT command. It also indicates transmission errors when you use MNP protocol. (See the accompanying sidebar on MNP.)

The back panel includes line and telephone jacks, reset button, volume control for the internal speaker, 25-pin connector, and a bank of DIP switches. (These switches are preset at the factory and should not be changed.)



Under the front panel, another bank of DIP switches presents a problem for the Apple II user. Since this modem is aimed at the Macintosh audience, the manual mostly explains the Mac software Codex also supplies. It explains the front-panel switches and suggests that other software may require you to change their orientation. It even shows their factory-preset positions, but it doesn't mention what they control.

A quick call to Product Support revealed that information (see the **Table**). Product Support uses an answering machine, and that worried me. But I had a call-back in less than an hour, and I didn't identify myself as a writer with *inCider*.

There's no power-off switch on the 2282. It's meant to be left on or unplugged (the typical procedure for devices used

Table. Front-panel switch-equivalency functions for the Codex 2282.

Sw #	Up	Down
1	Use DTR	DTR always high
2	Verbose result codes	Numeric result codes
3	Send result codes	Do not send result codes
4	Echo on	Echo off
5	Auto-answer on	Auto-answer off
6	DCD follows modem	DSR & DCD always high
7	212a mode (inhibits 2400-baud operation)	Permits 2400-baud operation
8		Always down

with mainframes and minicomputers). Also, the six-pin connector from its power transformer isn't keyed, but seems to work no matter what its orientation in the receptacle.

The Codex's MNP compatibility makes it an important modem to consider if you'll be attempting specialized file transfers.

Courier 2400

If seniority counts for anything, U.S. Robotics should have achieved prominence in the modem field long before anyone else. That it hasn't might have something to do with the fact that its modems were always pictured as bulbous, nondescript white things. Now that's changed.

The Courier 2400 is slim and black, with a gold faceplate and a red plastic lens covering the standard series



of LED status lights. The back panel has line and phone jacks, a 25-pin connector, and an on/off rocker switch. A slide switch on the side of the modem controls the volume of the internal speaker.

The DIP configuration switches are on the bottom of the modem. They're arranged in an open panel, so you won't need to pry anything up to reach them, but they're recessed so you can't accidentally reset them. Another switch controls the reversal of pins 2 and 3. (This is essentially what the jumper block on the Super Serial Card does when you change from printer to modem use.) Rather than resetting jumpers on your serial board, or keeping separate cables for printer and modem, just flipping the switch on the modem will usually make up the difference. It's an intelligent inclusion.

The Courier 2400's manual is noticeably slimmer than the other modems', but it doesn't seem to lack any information. In fact, along with the modem set-up and operation procedures, it contains a very good discourse on telecommunications theory I'd suggest any user read.

If you don't need the communications theory, you can almost throw the Courier 2400's manual away. You don't need it to configure the modem. U.S. Robotics has reprinted the AT commands, the S-register settings, a description of the status-light display, DIP-switch controls, and pin assignments for the RS-232 connector on the bottom of the modem. Provided you don't lose the modem, you don't need the manual.

Smartmodem 2400

Nothing can be more Hayes-compatible than a Hayes modem. If that's what you're looking for, go no further. The modem itself is pretty much standard Hayes fare, with a full complement of front-panel LEDs.

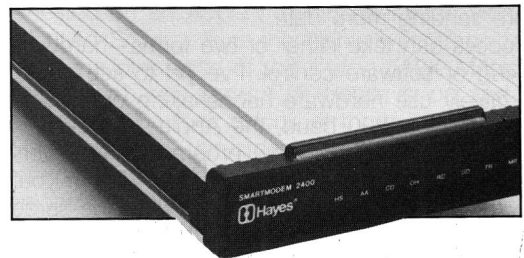

The back panel now has line and phone jacks, 25-pin connector, power receptacle, and on/off switch. There's no volume control—one of the S registers takes care of that.

The manual is another Hayes original, with cover-to-cover information. I might sound somewhat blasé about this modem, but Hayes is the stuff from which standards are made, and I've come to expect the level of excellence the company provides.

Professional 2400

I have an early 300-baud Novation modem on a shelf somewhere, and I expected the Professional 2400 to be simply a faster version of that slim, black box. I was wrong. From a purely subjective point of view, the Professional 2400 is an incredible exercise in fantasy.

This basic tan box is about two-thirds the height of the Hayes modem, and about a half-inch longer. The only light on the front is the red power-on LED. The volume control is a rotary switch partially recessed into one side (not the back).

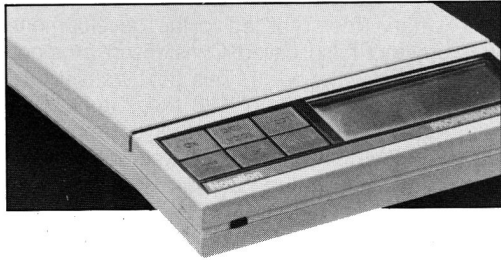

The back panel has line and phone jacks, a standard 25-pin connector, and a "feature module." This last accoutrement is a plug-in module containing three banks of eight DIP switches for configuring the modem's default settings. (You must reset four switches from their factory positions to force DCD, DTR, DSR, and CTS high before the modem will work with the Apple.)

A small panel on the top of the front end of the modem is actually the most interesting. It has five membrane switches: On/Off, Data/Voice, Test, Mode, and Speed.

A 2-by- $\frac{3}{4}$ -inch LCD screen on the panel indicates all status information. When you first turn on the modem, or if you press the test switch, it plays several tunes as various types of information are printed across your screen, detailing the modem's condition in English, not LED. While you're using the modem, it even flashes the words "send" and "receive" as data leave and enter it.

The manual details the operation of the modem itself with any generic software. Appendix B even supplies some cable configurations for various computers, although the Apple II is conspicuous by its absence.

One feature I can't applaud enough is the 2400 Professional's power supply. While other modems I've reviewed here have bulky power transformers with built-in power plugs, which can dominate a power strip or totter from a wall outlet, Novation terminates its transformer in a cable with a standard three-prong wall plug (much the same as Apple did for the //c). Also noteworthy is the fact that the Professional 2400 is the coolest-running of the four. This one exudes intelligent design.

Basic Data Transportation

Your data-communications needs might not be exotic enough to require the capabilities and expense of a 2400-baud modem. The idea of a cheaper, "no-frills" alternative is what sparked the creation of the Volkswagen Beetle, the Yugo, and roller skates.

It's also the root cause of the second section of this look at modems. While these other modems aren't sold in white boxes with a generic label "Modem" written across the front, they do represent compromises (sometimes significant) when compared to the current state of the art.

Computer Infograbber

The Computer Infograbber modem phone, manufactured by Unitech, is the least expensive modem I reviewed. This is a basic, bare-bones 300-baud modem. DAK Industries sells it for a meager \$49 (latest catalog price). If you're wondering how much of a modem it can be at that price, you might as well know it's also a tone/pulse-dial phone with ten-number memory and a speaker.

That's the nature of DAK's products. The company is almost a "Gadgets 'R' Us" operation that's mail-order only. The merchandise it sells is inexpensive and usually acquired because a manufacturer made a slight blunder

(like making a billion 300-baud modem phones just as the industry was switching over to 1200 baud).

The Infograbber is not Hayes AT command-compatible. It doesn't auto-dial, auto-answer, or auto-anything. But DAK also sells telecom software for the //e and //c for \$10 to handle the communications basics. (DAK also sells connecting cables and a serial interface for the //e.)

You can return the Infograbber to DAK within 30 days if you decide you don't like it (provided you don't double-dunk it in your fish tank or otherwise mistreat it). Of course, at \$49 you might forget the modem entirely, once the novelty wears off, and just use the phone.

The Volksmodem

The name is an immediate indication of this product's position in the marketplace. While Anchor Automation sells quite a variety of modems (including an MNP-compatible 300/1200/2400 model), the Volksmodem, at \$80, is its least expensive model. It shares the same dumb qualities as the Computer Infograbber and has been around almost as long as its namesake. The Volksmodem has a nonstandard connector for which Anchor can supply appropriate cables that work with a wide variety of computers.

For about \$60 more, you can take the next step up. At press time, Anchor was adding a new model to the 300-baud Volksmodem line. The newcomer is Hayes-compatible and full-featured.

The Apple Personal Modem

If desk or table space is a problem, Apple has solved it for you with the Personal Modem. The whole modem plugs into your wall outlet or power strip. Although it's styled with the Apple //c in mind, the Personal Modem doesn't look like very much. It's only about 3 by 2 $\frac{1}{4}$ by 1 inch (if you don't count the plug module), but it works at 300 and 1200 baud and is totally Hayes AT-compatible.

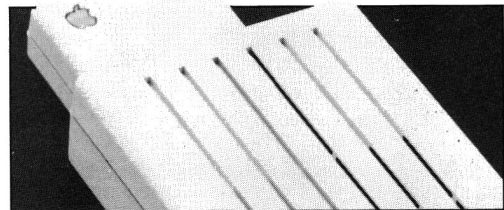

The top of the modem contains a single three-contact connector for the detachable plug module. The bottom has a volume control for the internal speaker (I don't know where they found the room to put it), line and phone jacks, plus a nonstandard 8-pin DIN connector (for space considerations—it requires $\frac{1}{8}$ the room of the usual DB-25 connector). There's no on/off switch, but the unit is only rated at .1 ($\frac{1}{10}$) ampere.

There is one LED positioned on the top. But assuming that your wall outlets are just above the baseboard, as are mine, this light probably won't be useful. There's always the internal speaker. It chirps when you first plug in the modem and again during the initial stages of connection with another modem. ■

Write to Bill O'Brien at P.O. Box 1010A, Fort Lee, NJ 07024.

MNP Protocol

A quick look down an ASCII chart will show you that any of the characters you might include as text fall within the ASCII decimal values of 32 and 126. These include the space bar, all upper- and lowercase characters of the alphabet, the numbers zero through nine, and any other symbols that appear on your keyboard (127 is the decimal code for the delete key; tab, return, escape, and all control codes fall below 32). These first 127 characters are called the standard character set, and the ASCII codes that define them are the same for all computers.

The nice thing about this is that in binary, the language of your computer, the equivalents of those decimal values are the range 0100000 (32) through 1111110 (126). If you count the ones and zeros, you'll discover there are seven binary digits, or bits.

When transmitting information by modem, the simplest communication protocol is called parity. It can be set for even, odd, or none. When a text character is transmitted, the sending program counts the number of ones in the 7 data bits. If you're using even parity and it finds an odd number of ones, it adds a one as the 8th bit. If you're using odd parity and there's an even number of ones, it also adds a one as the 8th bit. If the number of bits is correct for the version of parity you're using (or if you've selected no parity), it adds a zero as the 8th bit.

That works very well as low-level error correction for text data. If you know anything at all about ASCII or your Apple, though, you already know there are 256 possible ASCII characters (decimal 0-255), and that those above 127 require 8 bits. Decimal 255, the highest number your 8-bit computer can understand, is binary 11111111.

The characters above decimal 126 are used as symbolic shorthand in data files that aren't stored in text format, or for information contained in programs on your disk. Since these characters haven't been standardized, each computer manufacturer is free to use them as best suits the machine. For a while, they constituted the Apple II's extended character set. They're also the //e's Mouse Text characters.

Because these upper characters already require 8 bits, you can't use parity error checking to transmit or receive these binary files. That led to the development of XMODEM protocol (also called Christensen protocol, after the man who developed it). This 8-bit transfer method sends data in packets of 128 bytes (typically), then waits for confirmation from the other computer (also using XMODEM) that the packet was successfully received before it transmits the next one. If the transmission fails, it sends the information again until it succeeds or until a predetermined number of tries has elapsed, when it stops and tells you the transfer failed.

But we're moving on. Certain machines, like the Macintosh and possibly some future version of the Apple II, need more than simple 8-bit capability. The successor to XMODEM appears to be something called MNP protocol (which can also be used in an 8-bit environment). It's an effective, but currently alien, system that follows the Open Systems Interconnect model defined by the International Standards Organization.

Basically, it functions on four levels or layers. The first, or bottom, layer is the *physical* layer, composed of the actual computer hardware. The second, or *link* layer, provides verification services for the higher levels. This can occur under normal streaming transmissions (character by character) or under packet conditions.

The *session* layer defines the communications framework. When the session is initiated, each communications system tells the other what type of computer it is. If the same computer exists on both ends of the transmission, the session layer assumes they're using the same file formats and does relatively little. If they're different models, it invokes the next layer.

For different computers, the *application* layer translates a file into a virtual format particular to MNP and not to either of the computers. On the receiving end, this fourth layer then retranslates the virtual file into one that corresponds to the destination computer's file-system requirements.

Codex and Anchor Automation modems currently support this protocol. Apple, MCI, GTE Telenet, IBM, and other companies are seriously considering it for their own communications requirements. With computer needs and communication over voice-grade phone lines increasing, MNP will most likely play an important role in the telecommunications revolution. ■ —B.O'B.

Product Information

Codex 2282, \$795

Codex
20 Cabot Boulevard
Mansfield, MA 02048
(617) 364-2000

Reader Service Number 324

Computer Infograbber, \$49

\$10 (software)
DAK Industries
8200 Remmet Avenue
Canoga Park, CA 91304
(800) 423-2866

Reader Service Number 325

Courier 2400, \$699

U.S. Robotics
800 McCormick Boulevard
Skokie, IL 60076
(312) 982-5001

Reader Service Number 326

Personal Modem, \$399

Apple Computer
20525 Mariani Avenue
Cupertino, CA 95014
(408) 996-1010

Reader Service Number 327

Professional 2400, \$795

\$895 (with software)
Novation
20409 Prairie Street
Chatsworth, CA 91311
(818) 996-5060

Reader Service Number 328

Smartmodem 2400, \$899

Hayes Microcomputer
Products
705 Westech Drive
Norcross, GA 30092
(404) 449-8791

Reader Service Number 329

Softerm II, \$195

Softronic
3639 New Getwell, Suite 10
Memphis, TN 38119
(303) 593-9540

Reader Service Number 330

Volkmodem, \$80

Anchor Automation
6913 Valjean Avenue
Van Nuys, CA 91406
(818) 997-7758

Reader Service Number 331



MAKE A MODEM

If you're technically inclined, building a modem may be just the project you've been looking for.

by Perry Donham

If you're in the market for an inexpensive modem, this one is *cheap*. It's also ugly. I'm telling you that up front, so that when you've put it together, you won't call me in the middle of the night to complain about its looks. I need my sleep.

So what does this modem do? How much will it cost? Why would anyone want to build one? Reasonable questions. First, the what.

I think we all know what a modem *is*. Everyone's seen *War Games* and realizes that a modem is something you hook up to your telephone to talk to other people's computers. So let's ask instead what a modem *does*—specifically, this modem. I'll have to throw in a bit of *how* it does it, too.

The modem described here transmits and receives information at 300 baud (bits per second). To use it you'll need a telephone and a serial card in your Apple. It doesn't matter which Apple model you have. In fact, you needn't use an Apple at all, but this is an Apple magazine, so we'll stick with that. You might also need an empty Kleenex box, but we'll worry about that later.

Looking at the accompanying **Photos**, you may have noticed that this modem has no phone jack. It's acoustically coupled. Putting that handy little jack on the back costs quite a bit in design and in dollars, so we'll just leave it off—you can spend the extra money on the phone bill you'll get when you start using your new modem.

One more thing. You can't receive telephone calls with this *wunderbox*; you can only dial out. You can call a computer, such as the *inCider* bulletin board or Compu-Serve, but a computer can't call you. This shouldn't pose a problem unless you want to set up your own BBS.

How much will your project cost? About \$30, less if you have some parts lying around. The accompanying parts list (see the **Table**) shows prices for new components.

Construction

I'm going to assume that you know what a resistor looks like, and which end of an integrated circuit is the front. If you don't, find someone to help you.

Start by cutting a piece of perfboard to measure 2½ by 3½ inches. If you have the brown phenolic kind from Radio Shack, be *extremely* careful—it tends to shatter. Cut a slot in one of the narrow ends to fit a DB-25 connector; 1½ inches wide and ⅝ of an inch deep should do it. Use a metal fingernail file to enlarge the perf holes enough so that the connector's hardware will fit. (The best file to use is the kind that has a little hook on the end.)

Next install the sockets. Layout isn't critical, but it's easier to wire the sockets if you leave a bit of room between them. Leave a small space for the potentiometer.

Wire the power and ground leads first, leaving about 6 inches of extra wire at the end. It's a good idea to check for continuity with an ohmmeter: Simply put one lead on the first connection, the other lead on the last connection, and make certain the path is a short circuit (zero ohms).

Continue connecting the sockets together according to the schematic diagram (see the **Figure**). When you come to a nonsocketed component, such as the potentiometer, just solder a wire to the appropriate terminal. If you're not confident in your wire wrapping, check each circuit path with an ohmmeter as you go.

Once you're satisfied that the whole circuit is wired correctly, you can start on the acoustic coupler.

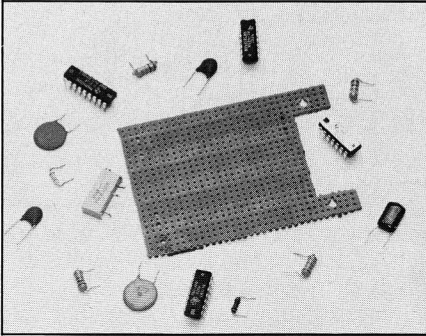

Step 1. How much will your project cost? About \$30, less if you have some parts lying around.

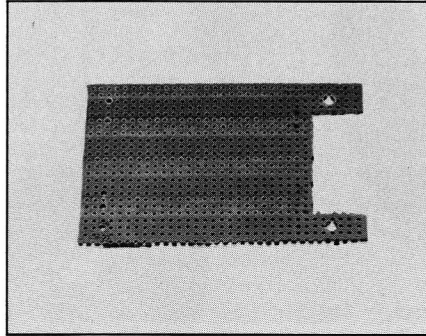

Step 2. Start by cutting a piece of perfboard to measure 2½ by 3½ inches. . .

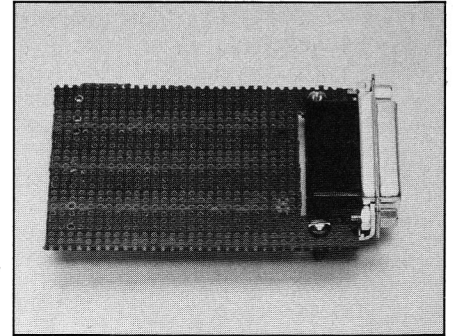

Step 3. Cut a slot in one of the narrow ends to fit a DB-25 connector: 1½ inches wide and ⅞ of an inch deep. . .

The most difficult part of this project was figuring out what to use to attach the modem to the telephone. I could have splurged and bought real acoustic-coupling cups somewhere, but they would have cost more than the rest of the parts combined.

I looked at balls, toilet flappers, all kinds of things in my local hardware store. Finally I just wandered around, hoping something would come to me. What I found was a little rubber thing that holds soap down on your sink. It has tiny suction cups all over both sides. I also found some small plastic funnels with a wide opening exactly fitting the soap suckers.

To make the acoustic funnels, first wire both the speaker and the microphone, and leave a couple of feet of cable on each one. I happened to have some three-conductor intercom cable on hand, but you can use individual wires if you like. Be careful when you solder wires to the microphone element: Too much heat applied for too long can ruin it. Use superglue or a hot-melt glue gun to mount the speaker and mike. (The mike fits very nicely into the narrow neck of the funnel.)

Now cut the little suction cups off on one side of each of the two soap holders. You need to remove only the outer ring. Cut a small hole in the center of each holder, then glue them to the funnels. While you're gluing, drop a little into the spot where the cable enters the funnel (this will anchor the cable).

Installation

Installing your modem can be a little tricky if you have peripheral cards in your machine. The best place to tap the power bus is right next to the power supply, so look for a spot on the left rear of your computer. I used the DB-25 connector to mount the modem in hole number 10; it just fits with Apple's 64K/80-column card in the //e's auxiliary slot. You don't have to mount the modem inside the computer, but you'll get fewer rude comments from your friends if you do.

To get power to your modem, tap four capacitors on the upper left corner of the motherboard (near the power supply): C9 for +5 volts, C12 for +12 volts, C17 for -5 volts, and C15 for -12 volts. Solder your power line to the *right-hand* lead of the capacitor for *negative* voltage,

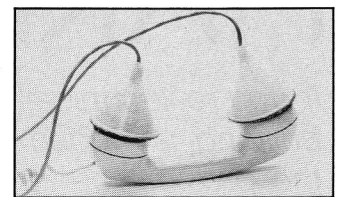
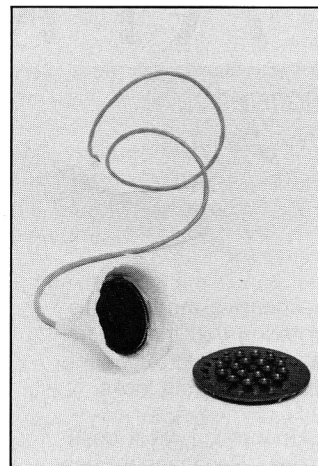

Table. Parts list for modem project.

Equipment	Price
Resistors (¼ watt)	
680	\$.19
10k	.19
22k	.19
56k	.19
220k	.19
330k	.19
10M	.19
100k pot	.50
Capacitors	
18 pF (2)	.80
.1 mF (2)	.80
Integrated circuits	
1488 line receiver	1.79
1489 line driver	1.79
TM99532	9.95
LM324 quad op amp	1.29
Miscellaneous	
4.032 MHz crystal, parallel resonant, +/- .005%	6.50
Electret microphone	.79
2 soap holders	1.58
2 2-ounce funnels	.58
perfboard	1.49
2-inch speaker, 8 ohm	1.89
DB-25 male, pc-mount	3.29
IC sockets	
5 14-pin, 1 18-pin	1.80

Suppliers

Jameco Electronics

1355 Shoreway Road
Belmont, CA 94002
(415) 592-8097
(any part except crystal)

Reader Service Number 300

JAN Crystal

P.O. Box 06017
Fort Myers, FL 33906-6017
(813) 936-2397

Reader Service Number 301

Tandy/Radio Shack

National Parts Division
900 East Northside Drive
Fort Worth, TX 76102
(817) 870-5662
(any part except crystal and modem chip)

Reader Service Number 302

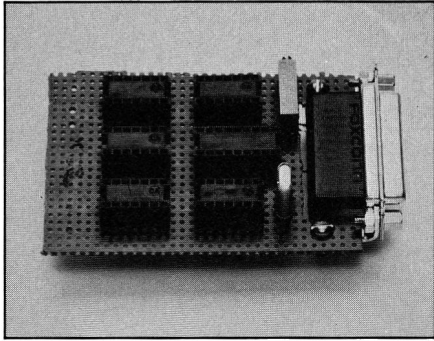

Step 4. Next, install the sockets. Layout isn't critical.

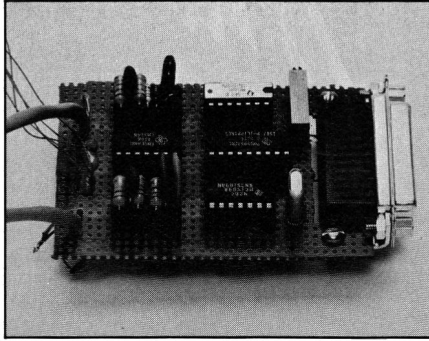

Step 5. Wire the power and ground leads, first leaving about 6 inches of wire.

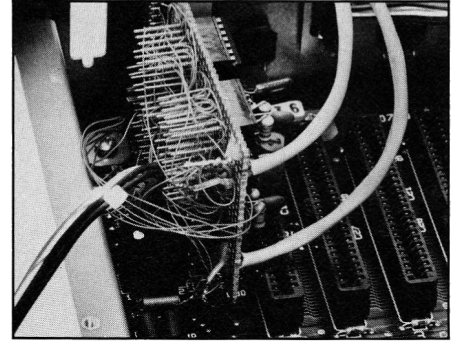

Step 6. The best place to tap the power bus is right next to the power supply.

and to the *left-hand* lead for *positive* voltage. Wrap your ground lead around a small screw and attach the screw to the power-supply case.

Configure your serial card to send and receive data at 300 baud. Connect the appropriate cable between the modem and your serial card (male DB-25 on the modem end; check your serial card's manual for the right connector for the other end). Take a deep breath, and turn on the power. (I've gotten into the habit of doing this from under a heavy table.)

Operation

With luck, you now have a working modem. To use it, get into BASIC and type PR#2 <return>, then IN#2 <return>. If your serial card is in a slot other than 2, just substitute that slot number. These two commands direct output (PR#) and input (IN#) to and from the device in slot 2. Now pick up your telephone and dial a number a computer will answer, such as the *inCider* BBS, (603) 924-9801.

Firmly attach the speaker/funnel to the mouthpiece of the phone, and attach the microphone/funnel to the ear-

piece. Gently lay the handset aside. (If your handset tends to tip over, try sticking it in an empty Kleenex box.) The distant computer will answer its telephone, and you can begin your session. Hang up the phone when you're finished.

You should also be able to use your new modem with commercial communications packages such as Apple Access II.

Last Bits

The design of this modem is a modified version of a circuit published in Texas Instruments' data manual for the TM99532. If you're interested in enhancing this basic circuit or are curious about single-chip modems, contact TI (P.O. Box 1443, Houston, TX 77001) and cajole the customer-service people into sending you the data book. I found the starving-author routine very effective, but you might want to be a little more original. ■

Write to Perry Donham at Route 2, Box 229B, Rindge, NH 03461.

Figure. Schematic diagram for modem project.

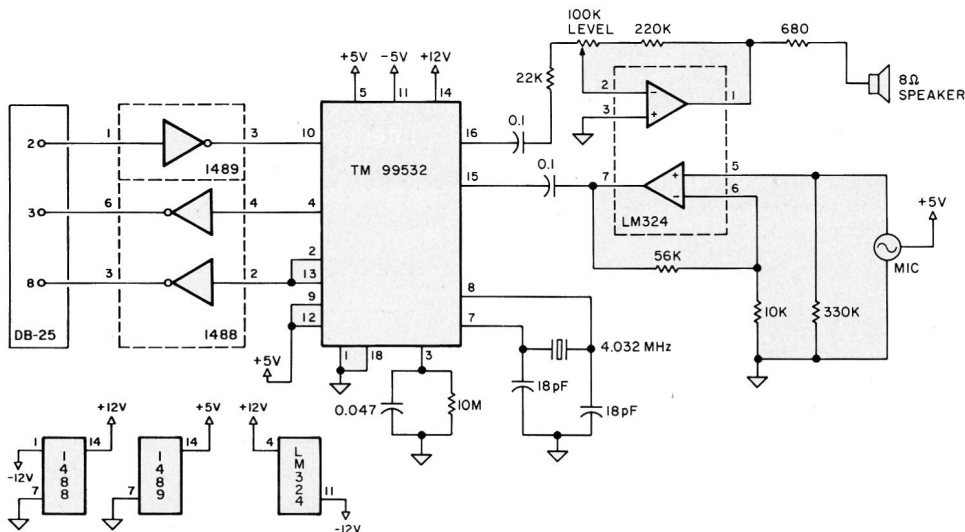

Interlude II

A BED OF ROSES—INTERLUDE # 136

Why did you bring me so many roses?

It was Interlude's idea.

Oh?

Imagine lying in a bed of roses...

Sounds a bit thorny.

Just the petals, darling...cool, velvety, fragrant.

Oh. Oooooooh.

Interlude II. The long-awaited sequel to the first adult computer game in history is finally here. It's provocative and playful! Outrageous and romantic! It has all the excitement of the original Interlude, plus significant new features.

The computerized interview, which is taken by one or both players, has been greatly expanded. It probes your innermost desires to discern your mood of the moment, your secret longings, your special fantasies, and then suggests for your pleasure one of its more than 160 Interludes. You can ask the computer for an Interlude for now, or one for later.

Special options give each player added control over surprises and special erotica hidden in the Interludes.

Six years ago the original Interlude took the computer world by storm, creating a media sensation:

FORUM Magazine: *"The Interludes are imaginatively and sensitively written...the computer's recommendations are uncannily appropriate."*

US Magazine: *"The most edifying third party to join couples between the sheets since The Joy of Sex."*

Chicago Tribune: *"This marriage of computer technology and sex is natural...erases forever the image of computer-users as dull guys with slide rules in their pockets and square roots on their minds."*

Money Magazine: *"Sometimes it's easier to tell a computer what you want than it is to tell your partner."*

Interlude II will take you to the outer limits of fantasy and romance. And, if the computer selects Interlude #99 your love life may never again be the same.

Interlude II. Are you ready for it?

Circle 253 on Reader Service Card.

Send your check for \$39.95 plus shipping charges of 3.00 (outside U.S.A.—10.00 shipping) or charge information to:

INTERLUDE, 11011 Richmond, Suite 600, Houston, TX 77042

NAME _____ AGE _____

ADDRESS _____

CITY _____ STATE _____ ZIP _____

CHARGE CUSTOMERS MUST SIGN HERE _____

____ MASTERCARD ____ VISA ACCOUNT NO. _____ EXPIRATION _____

CHARGE CUSTOMERS: **1-800-752-7001 ext. 829**

(in Texas call 1-800-442-4799 ext. 829)

Available for Apple II, II+ and IIe.¹

¹Trademarks of Apple Computer, Inc.



APPLEWORKS IN ACTION

Cutting and Pasting with AppleWorks

by Ruth K. Witkin

If this month's column were a movie, it could be called *Rocky Hill III*, the last in a trilogy starring the Rocky Hill Hardware Supply Company. The saga that began with mailing labels and a spreadsheet now winds up with the integrated document shown in **Figure 1**.

In this episode, you compose a price quote letter, then "cut" a piece from the quotation spreadsheet and "paste" it into the letter—without scissors, tape, or staples. It's all done electronically and, yes, effortlessly. If you haven't created the spreadsheet (see last month's *inCider*, April 1986, p. 76), now is a good time to do it.

The letter is a form letter you might send to any customer requesting a price quote, but there's something special about this one. AppleWorks lets you stop the printer to type information specific to each customer, which makes even a form letter look unique.

Creating the Document from Scratch

Use the Startup and Program disks to bring up a new word-processor screen. Name this file **QUOTE LETTER**. You should now see the Review/Add/Change screen. To avoid switching disks in midstream, slip the disk containing the QUOTE spreadsheet into the current drive. When you see such key combinations as OA-Z, hold down the open apple key and type Z.

Entering the Text

Figure 2 shows the text of the letter. Those gaps in the salutation and the first and last paragraphs are places where the printer pauses to let you enter information from the keyboard. The numbers at the left correspond to the line numbers that appear at the bottom of the screen as you type.

Word wraparound makes any word that can't fit at the end of a line move down to the next line automati-

Integrate last month's spreadsheet price quote with an AppleWorks word-processed document.

cally. You press the return key only to end a paragraph or insert a blank line between paragraphs, indicated in **Figure 2** by dotted rectangles called *blots*. Press OA-Z to keep the blots on the screen as you work.

Now enter the text according to the instructions you see in the **Table**.

Figure 1. AppleWorks quotation spreadsheet integrated with a letter to a customer.

Rocky Hill Hardware Supply Co.

5 Main Street
Abner, New York 11999
(516) 555-0505

May 1, 1986

Mr. Robert J. Nissen
Owner
Nissen Brothers, Inc.
905 Linden Mall
Abner, New York 11999

Dear Bob:

We are pleased to submit the following quote to Nissen Brothers, per your request of April 29, 1986.

We've just introduced a new Phillips screwdriver, catalog #259, to replace #256. It's stronger and has a wider grip that fits the hand remarkably well. Better yet, the price is 35 cents less per piece, a savings of \$4.20 per dozen.

Qty	Item #	Description	Unit Price	Extended Price
48	259	Phillips Screwdrivers	\$2.50	\$120.00
24	250	Crescent Wrenches	\$6.75	\$162.00
24	210	Harris Drill Sets	\$32.55	\$781.20
12	283	Cartons 20d Common Nails	\$65.00	\$780.00
			Subtotal	\$1,843.20
			Discount	\$92.16
			Total	\$1,751.04

We appreciate your business, Bob. Please call me or Ron Dugan with any questions.

Cordially,

Herbert C. McCall
President

POWER UP YOUR BUSINESS . . . SUCCESS WITH APPLEWORKS!

An exclusive collection of 10 easy-to-use templates on a disk that will get the power of AppleWorks working for you!

Here's the kind of "computer-ease" that goes right to your bottom line! Ten time-saving, work-saving templates that make AppleWorks a full time partner in your business. Instant know-how you can apply immediately to a wide range of valuable business needs, including:

- Build a Mailing List
- Prepare a Price Quote
- Personalized Form Letter
- Design a Poster or Sign
- Create a Customer Database
- Figure a Loan Amortization
- Publish a Company Newsletter
- Analyze your Personal or Business Balance Sheet
- Plan a Home or Business Budget
- Prepare an Annual Expense Summary

Imagine! Any one of the applications included would be worth the low cost of this unique disk all by itself. But you get all ten, ready-to-run templates for just \$29.97. Less than \$3.00 each, PLUS a detailed documentation booklet that guides you quickly and easily into each application.

Start Boosting Your Personal Productivity Now!

Complete the coupon or attached Order Card and mail with payment or CALL TOLL FREE and charge it to your credit card for quickest service and the surest way to boost your productivity . . . turn your Apple II into a profit center for your business!

CALL TOLL FREE 1-800-258-5473 (In NH, dial 1-924-9471)

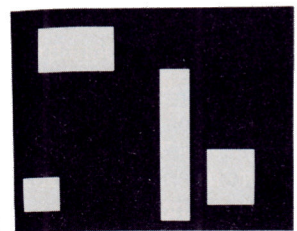
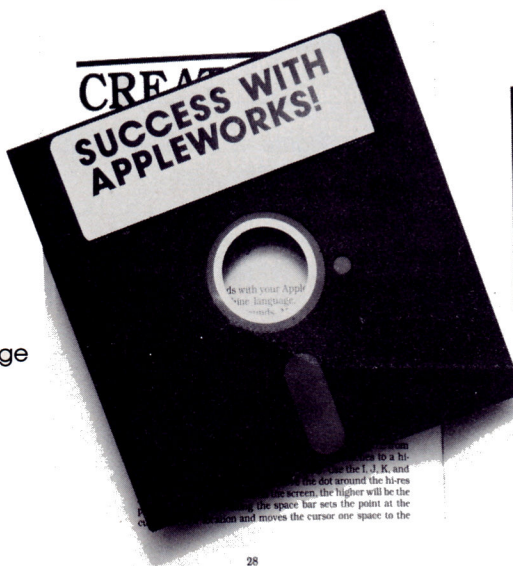

Photo 2. Example using the FILL routine.

BEWARE it with different parameters. FILL should be saved so that it doesn't cross a page boundary. Once you relocate FILL, be sure to change the CALL statement to reflect its new location. You will also have to relocate HMEM to protect the routine in its new location.

When using FILL, be certain that the point you HPLLOT before calling the routine is inside the object you want to fill. If the point lies on the border or outside of an object, you'll get some strange results. ■

YES, send me the added power of hotCider's SUCCESS WITH APPLEWORKS. I get 10 ready-to-run Templates on a disk, plus complete documentation booklet for just \$29.97

Foreign Airmail, add US \$1.50 per item.

() Payment enclosed () Visa () Amex () MC

Card # _____ Exp. Date _____

Signature _____

(print) Name _____

Address _____

City _____ State _____ Zip _____

Mail to: **hotCider**
80 Pine St.
Peterborough NH 03458

5-86

*AppleWorks and Apple are registered trademarks of Apple Computer, Inc.

APPLEWORKS IN ACTION

Figure 2. Text of the customer letter created on the AppleWorks word processor.

```
LINE
1 Dear :
2
3 We are pleased to submit the following quote to , per your
4 request of .
5
6 We've just introduced a new Phillips screwdriver, catalog
7 #259, to replace #256. It's stronger and has a wider grip
8 that fits the hand remarkably well. Better yet, the price is
9 35 cents less per piece, a savings of $4.20 per dozen.
10
11 We appreciate your business, . Please call me or Ron Dugan
12 with any questions.
13
14 Cordially,
15 Herbert C. McCall
16 President
```

Where you see (space), press the space bar once. Be sure there is *only one space between characters* at that point. If you make a typo, press the delete key to back up the cursor and erase the character before it. Your cursor should be in line 1 column 1.

Check the text to make sure it agrees with **Figure 2**. If something is missing, place the insert cursor (the blinking underline) on the character to the right of the insertion. If you dis-

cover a typo, place the overtype cursor (the blinking rectangle) atop the character you want to replace. Press OA-E to switch between the cursors.

The following keys move the cursor from one place to another: the left and right arrows move the cursor one character at a time in the direction of the arrow. The down and up arrows move the cursor one line at a time. OA-left arrow and OA-right arrow hop the cursor from word to word. OA-1

to OA-9 jump the cursor vertically through the document in proportional increments.

Inserting the Printer Pauses

The next step is to tell AppleWorks where you want the printer to pause for keyboard input, indicated in **Figure 3** by carets (^). Press OA-1 to jump the cursor to line 1 column 1. Let's start with the date. Press OA-O to bring up the Printer Options screen. Now type **EK**, press Return, press the escape key, and press Return again.

The cursor is now in line 2 column 1. Repeat these steps five more times to insert stops for the recipient's name, title, and address. In each case, press OA-O, type **EK**, and press Return. Then press Escape and Return to move to the next line down. When you finish, the cursor should be in line 7 column 1 (atop the D in Dear). Now press Return to insert a blank line.

The next stop enters a pause for the name in the salutation. Move the cursor to line 8 column 6 (atop the colon) and press OA-O, type **EK**, press Re-

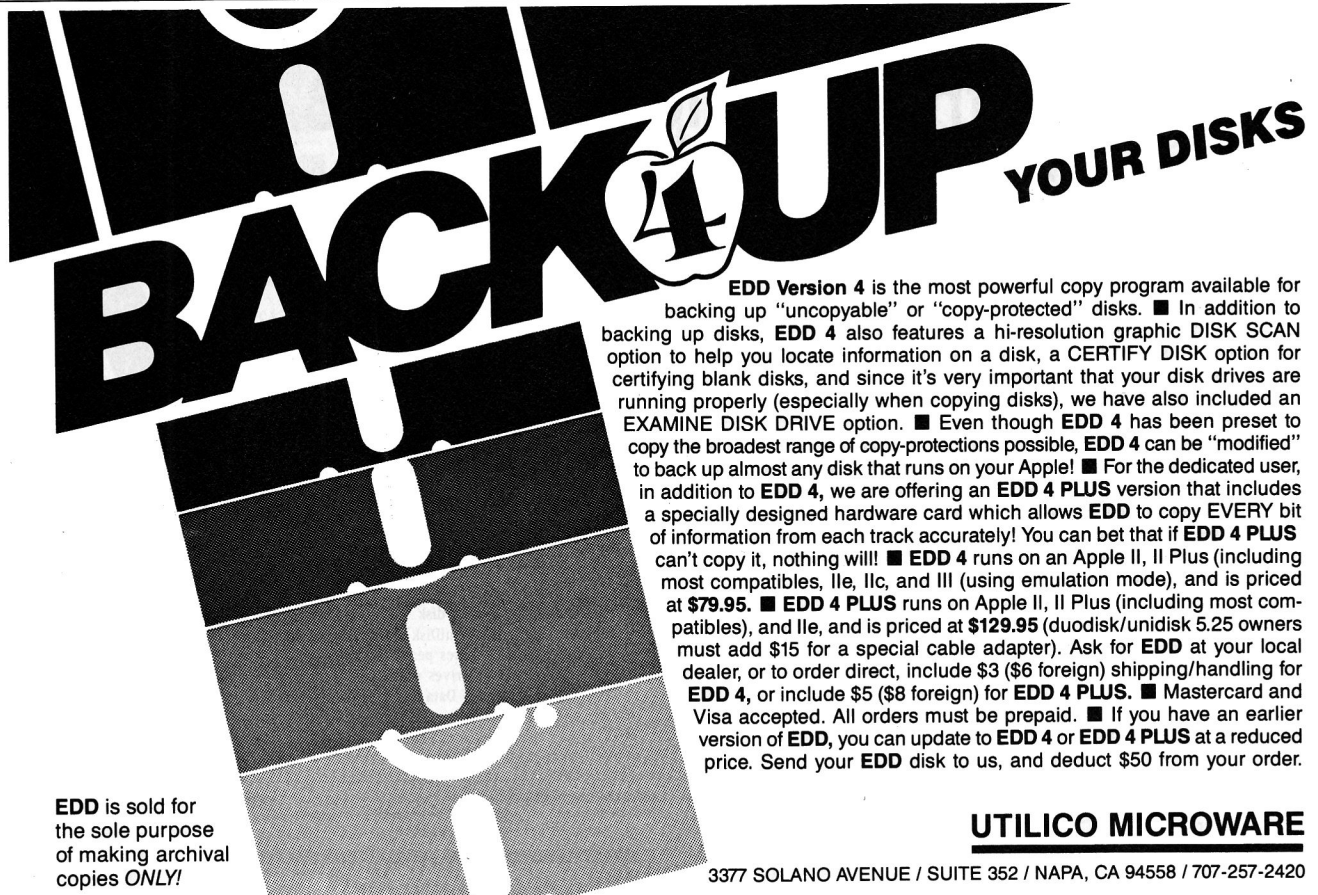

BACKUP YOUR DISKS

EDD Version 4 is the most powerful copy program available for backing up "uncopyable" or "copy-protected" disks. ■ In addition to backing up disks, **EDD 4** also features a hi-resolution graphic DISK SCAN option to help you locate information on a disk, a CERTIFY DISK option for certifying blank disks, and since it's very important that your disk drives are running properly (especially when copying disks), we have also included an EXAMINE DISK DRIVE option. ■ Even though **EDD 4** has been preset to copy the broadest range of copy-protections possible, **EDD 4** can be "modified" to back up almost any disk that runs on your Apple! ■ For the dedicated user, in addition to **EDD 4**, we are offering an **EDD 4 PLUS** version that includes a specially designed hardware card which allows **EDD** to copy EVERY bit of information from each track accurately! You can bet that if **EDD 4 PLUS** can't copy it, nothing will! ■ **EDD 4** runs on an Apple II, II Plus (including most compatibles, IIe, IIc, and III (using emulation mode)), and is priced at **\$79.95**. ■ **EDD 4 PLUS** runs on Apple II, II Plus (including most compatibles), and IIe, and is priced at **\$129.95** (duodisk/unidisk 5.25 owners must add \$15 for a special cable adapter). Ask for **EDD** at your local dealer, or to order direct, include \$3 (\$6 foreign) shipping/handling for **EDD 4**, or include \$5 (\$8 foreign) for **EDD 4 PLUS**. ■ Mastercard and Visa accepted. All orders must be prepaid. ■ If you have an earlier version of **EDD**, you can update to **EDD 4** or **EDD 4 PLUS** at a reduced price. Send your **EDD** disk to us, and deduct \$50 from your order.

EDD is sold for the sole purpose of making archival copies **ONLY!**

UTILICO MICROWARE
3377 SOLANO AVENUE / SUITE 352 / NAPA, CA 94558 / 707-257-2420

ESSENTIAL DATA DUPLICATOR 4

turn, then press the escape key.

Now, in the same way, insert printer stops at the following places, the first for the company name, the second for the RFQ date, and the third for the recipient name:

Line 10 column 49 (atop the comma)
 Line 11 column 12 (atop the period)
 Line 18 column 30 (atop the period)

Compare your screen with **Figure 3** to make sure the carets are in the right places.

Skipping Lines

Traditional letter spacing calls for four blank lines between the date (the first stop) and the recipient's name (the second stop). Pressing Return to insert lines is fast and easy, but use the Skip Lines feature instead. Press OA-1 to jump the cursor to line 1 column 1. Now press the down arrow key to move the cursor to line 2 column 1. The cursor is atop a caret, so you see *Enter Keyboard* at the bottom of the screen instead of the line and column numbers.

Table. Instructions for entering form letters.

Line	Action
1	Type <i>Dear(space)</i> : and press Return twice to end the paragraph and insert a blank line. The cursor moves to line 3.
3	Type <i>We are pleased to submit the following quote to(space), per your request of(space)</i> . Press Return twice. The cursor moves to line 6.
6	Press the space bar only once between sentences and type: <i>We've just introduced a new Phillips screwdriver, catalog #259, to replace #256. It's stronger and has a wider grip that fits the hand remarkably well. Better yet, the price is 35 cents less per piece, a savings of \$4.20 per dozen.</i> Press Return twice. The cursor moves to line 11.
11	Type <i>We appreciate your business,(space). Please call me or Ron Dugan with any questions.</i> Press Return twice. The cursor moves to line 14.
14	Type <i>Cordially</i> , and press Return. The cursor moves to line 15.
15	Type <i>Herbert C. McCall</i> and press Return. The cursor moves to line 16.
16	Type <i>President</i> and don't bother to press Return. The cursor should now be in line 16 column 10.

Press OA-O to bring up the Printer Options screen. Tell AppleWorks to skip four lines: Type **SK**, press Return, type **4**, and press Return again.

and press Return. Press the escape key to exit the Printer Options screen.

Justifying the Text

Justifying prints the text with an even right edge. You are still in the Printer Options screen, so type **JU**

Skipping More Lines

To allow room for a signature, skip four lines after *Cordially*. Press OA-8, then down arrow twice to move the cursor to line 24 column 1. Now press OA-O, type **SK**, and press Re-

UniDOS 3.3 For the Apple UniDisk 3.5

Apple's new 800K UniDisk drive gives you five times the storage capacity of floppy disks — but no DOS 3.3. Now you can have it — with UniDOS 3.3!

MicroSPARC's UniDOS 3.3 software lets you format 3.5 inch disks that automatically boot up Apple's DOS 3.3! This means:

- You'll enjoy a 500% + increase in disk capacity. . . 800K per disk, for those BIG applications.
- You'll protect your investment in DOS 3.3 software* and files.
- You can grow to 1.6 megabytes of disk capacity painlessly. . . without having to convert to ProDOS.

You don't have to wait any longer to buy the UniDisk 3.5 . . . now that UniDOS 3.3 is here. Order now!

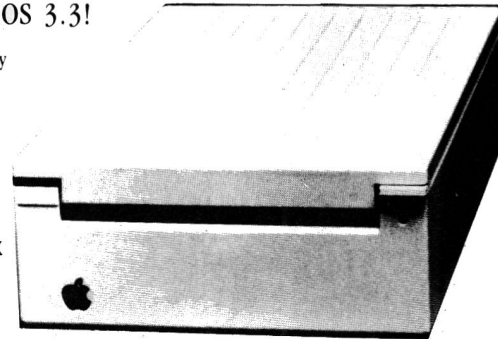

I want UniDOS 3.3! Here's my \$49.95 Postpaid

Check, M.O. (Payable in U.S. funds only)
 (Mass. residents add 5% sales tax)

Name _____

Address _____

City _____ State _____ Zip _____

MasterCard Visa

Signature _____ Tel. # _____

Charge Card # _____ Exp. Date _____ IC _____

MicroSPARC Inc., 45 Winthrop St., Concord, MA 01742 (617) 371-1660

The UniDOS 3.3 facts:

- Two 400K volumes per disk.
- Supports one or two UniDisk 3.5's, addressable as Drives 1-4.
- Up to 434 Catalog names per disk.
- Mix 5.25" and 3.5" drives within the same system.
- Comes with Technical Data Sheet showing modified DOS 3.3 addresses.
- Uses only 1K of user memory.
- Developer licenses are available.
- For the Apple II Plus, //e and //c

* Note: Full compatibility with Applesoft programs. However, UniDOS 3.3 may not operate correctly with machine language utility programs that directly use DOS 3.3 internal routines. Apple and UniDisk 3.5 are registered trademarks of Apple Computer, Inc.

turn. Type **4**, press Return, and press the escape key. To store the letter on disk, press OA-S.

Working with the Quotation Spreadsheet

The next step is to load the quotation spreadsheet so you can "cut and paste" it into the letter. Be sure the disk containing QUOTE is in the current drive. Return to the main menu, confirm *Add files to the Desktop* and confirm *The current disk* by pressing the escape key, then Return twice. At the *AppleWorks files* menu, press the down arrow key until the highlight is on QUOTE and press Return.

First, keep the spreadsheet header (file name and date) from printing: Press OA-O, type **PH**, and press Return. Press the escape key to return the spreadsheet to the screen.

The next task is to "cut" the quote part of the spreadsheet and print it to the clipboard, which holds information destined for another file. Move the cursor to row 3 by pressing OA-2, then up arrow. Now follow these

Figure 3. Customer letter with carets showing the printer pauses for keyboard input.



Dear [X]:

We are pleased to submit the following quote to [X], per your request of [X].

We've just introduced a new Phillips screwdriver, catalog #259, to replace #256. It's stronger and has a wider grip that fits the hand remarkably well. Better yet, the price is 35 cents less per piece, a savings of \$4.20 per dozen.

We appreciate your business, [X]. Please call me or Ron Dugan with any questions.

steps to start the Print command, select the *Rows* option, and highlight rows 3 to 14: Press OA-P, type **R**, press OA-5, down arrow, and press Return.

Tell AppleWorks to print these rows

to *The clipboard* (for the *Word Processor*) by typing **2** and pressing Return. AppleWorks confirms that the spreadsheet is indeed on the clipboard and can now be transferred to a word-processor document. Switch to



EquiDisk + TM

We've got a lot in store for you!

The EquiDisk + is the next generation in 5¼" floppy disk storage — and it's here today! Unlike your old Apple drives that were probably too small for any real work, the EquiDisk + dual drive system gives you over 1.4 megabytes of immediately accessible on-line storage. Now you can store over 7 megabytes of data with that box of diskettes sitting on your shelf. That's over 3500 double-spaced pages, or 70,000 names and addresses, or complete payroll information for more than 4000 employees. And with that second box of diskettes on your shelf you can back it all up.

More than just Storage!

- + The EquiDisk + works with DOS 3.3, ProDOS and CP/M
- + Standard 5¼" diskettes are all you need.
- + The entire unit fits neatly between your monitor and computer console.

Apple, Apple Logo, DOS 3.3, ProDOS and AppleWorks are registered trademarks of Apple Computer, Inc. CP/M is a registered trademark of Digital Research, Inc. TeleVideo is a registered trademark of TeleVideo Systems, Inc. Franklin Ace is a trademark of Franklin Computer Corp.

- + Each EquiDisk + comes with a surge suppressor; three built-in AC outlets on the back and a front-mounted power switch. You can turn everything on and off at the same time.
- + CP/M users can access software formatted for other computers. EquiDisk + drive 1 can be reconfigured to run TeleVideo software. Using one of the commercially available "transfer" programs, this feature allows you to access any CP/M software and run it on your Apple.
- + Works with the Franklin Ace 2000 series.

More for Everyone!

- + AppleWorks — now your data disk will hold 717K . . . checkbook records for 5 years; every term paper or book report you've ever done; every recipe in your kitchen and the Christmas mailing list . . . on one diskette.
- + Programmers — all of your assemblers, linkers, compilers, editors and

debuggers, as well as your source code . . . on one diskette.

- + Business — months of payroll, accounts receivable and payable, general ledger and daily correspondence . . . on one diskette.
- + Educators — consolidate all of your skill drills and tutorials, with room for individual work . . . on one diskette.

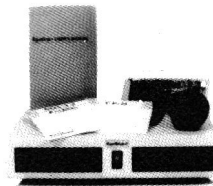

\$679⁰⁰

Includes dual drives, case, cables, controller card, manual and software.



Minimum system configuration:

*Apple II+ or IIe with 64K RAM
*One standard Apple or equivalent drive

H & M Disk Drives
1101 E. Pacifico
Anaheim, CA 92805
(714) 385-1146

Dealer inquiries welcome.

the Desktop Index and bring QUOTE LETTER to the screen: Press OA-Q, press the up arrow key, and press Return.

Press OA-7 to jump the cursor to line 20 column 1. Now "paste" the spreadsheet into the letter by pressing OA-M and typing F. Ah, sweet success—but only to a point. The standard width of the letter is too narrow for the spreadsheet, making the right column huddle at the left margin.

Formatting the Document

Reducing the left and right margins gives the spreadsheet room to spread out. Press OA-1 to jump the cursor to the top line. Press OA-O to bring up the Printer Options screen. Now type **LM**, press Return, type **.8**, and press Return again. Type **RM**, press Return, type **.8**, and press Return.

A two-inch top margin allows room for a letterhead. You are still in the Printer Options screen, so type **TM** and press Return. Type **2** and press

Return again. Press the escape key to return to the spreadsheet. Now press OA-6 to see the result. That's more like it. The wraparound is gone and everything is as it should be.

It's a good idea to preview the page breaks before printing to see if further changes are needed. To do this, press OA-K, press Return, and press OA-9. Uh-oh. Page 1 ends between McCall's name and his title. That will never do. The simple solution is to reduce the bottom margin. Press OA-1 to jump the cursor to the top line. Press OA-O, type **BM**, and press Return. Now type **1**, press Return, and press the escape key.

Let's check the page break again: Press OA-K, Return, and OA-9. The Page 1 indicator shows that everything will print on one page. Press OA-S to store the document on disk.

Printing the Document

Turn on your printer and follow these steps to start the Print command, confirm *Beginning*, printer, and one copy: Press OA-P and then Return. Press Return (or type a printer number, then Return) and press Return again.

Entering Information from the Keyboard

The printer pauses, awaiting input from the keyboard. Take your time, and if you mistype anything before pressing Return, the delete key backs up the cursor.

Now type **May 1, 1986** and press Return. The printer pauses again. Type **Mr. Robert J. Nissen** and press Return. At each pause, type an entry and press Return until you type in all of the following entries: **Owner, Nissen Brothers, Inc., 905 Linden Mall, Abner, New York 11999, Bob, Nissen Brothers, April 29, 1986, Bob.** Your letter should now look like the one in **Figure 1**.

Next month, I'll explain how to create an AppleWorks spreadsheet to do price-volume analysis. ■

Ruth K. Witkin is a consultant in computer applications for business. She is the author of Managing Your Business With Multiplan (Microsoft Press), Managing With AppleWorks (Howard W. Sams & Co.), Personal Money Management With Multiplan (Hayden Books), and Personal Money Management With AppleWorks (Hayden Books). Write to her at 5 Patricia Street, Plainview, NY 11803.

Can't Run AppleWorks™ On Your Apple II or II+? Now You Can!

With The Legend S' Card™
and Free AppleWorks™ Patch
Get a Megabyte Of AppleWorks™
Desktop!

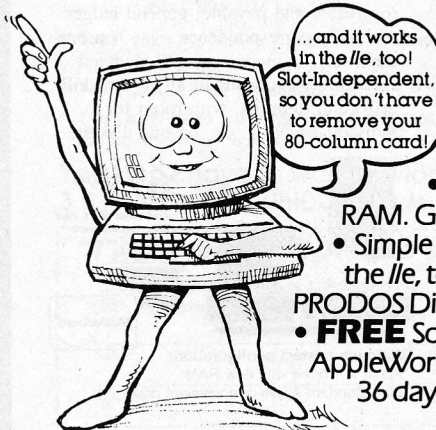

Legend S' Card™

- Slot-Independent. You pick the best slot for your RAM card.
- Upgradable from 256K to 1024 K RAM. Gives 1024 K AppleWorks Desktop!
- Simple to install on the Apple II/II+ (and the //e, too) • DOS, CP/M, PASCAL, SOS, PRODOS Disk Emulators available.
- **FREE** Software Patch gives Full-Featured AppleWorks™ • Satisfaction Guaranteed. 36 day refund policy.

For More Information Contact:
LEGEND INDUSTRIES, LTD.

2220 Scott Lake Road
Pontiac, MI 48054
(800) 5-LEGEND or (313) 674-0953

Legend and S' Card are trademarks of Legend Industries, Ltd. Apple and AppleWorks are trademarks of Apple Computer, Inc.

APPLESOFT ADVISER

Enhancing Your Applesoft Bar Builder

by Dan Bishop

In March's Applesoft Adviser (p. 92), I presented Bar Builder, a program that uses low-resolution graphics to build a bar graph, or histogram, from a single set of data containing up to 38 elements. That program produces two alternating colors for contrast, letting you display two sets of data by ensuring that all odd-numbered entries come from the first data set and all even-numbered entries from the second.

This month I'll expand on Bar Builder (see the **Program listing**), to let it handle up to four sets of data. The resulting graph (see the **Figure**) will be more interesting visually, since the bars for each group of points will partially overlap, creating a three-dimensional effect. The Applesoft concepts this program illustrates are multidimensional arrays, the PLOT command, and the SCRNL function.

Upgrading Bar Builder

When you begin designing enhancements for an existing program, the first thing you should consider is how much of the original program you want to keep. Since the original Bar Builder is useful for one or two data sets, you'll want to be sure that the changes you make in the program don't interfere with these functions. To emphasize this, I'll call attention to the effect each alteration has on the original program.

In expanding the program from one data set to four, you must first determine the appropriate data structure. Line 100 in Bar Builder is:

```
100 DIM D(40),ND(40),T$(3)
```

with the D array containing the raw data points you want to graph, and the ND array containing the adjusted, or "normalized," values.

Bar Builder II must still be able to handle 40 data points for single sets of data, but must also accommodate up to four separate data sets. The

Multidimensioned Applesoft arrays let you create lo-res overlapping bar graphs in color.

simplest data representation for this is a two-dimensional array. The original arrays the first Bar Builder program dimensions must now be dimensioned differently for Bar Builder II:

```
100 DIM D(40,4),ND(40,4),T$(3)
```

The second subscript in the D and ND arrays refers to the specific data set to which each element belongs. When you use the program for a single set, all elements will use 1 as the second subscript, as in D(23,1).

Next you must look through the original program for all references to the D and ND arrays, and change them to reflect their new dimensionalities. To begin, lines 120 through 150 in Bar Builder initialize the D array to contain all zeros. This requires a single loop, since D has just a single dimension. Bar Builder II requires two

loops nested within each other to handle two-dimensional arrays (lines 130 through 150).

Line 100 in Bar Builder II also dimensions four new arrays. The C(i) array contains four color codes the graph assigns to the COLOR command. The W(i,j) array handles bar widths, and the MG(i,j) array takes care of the left margin for the display. The original Bar Builder uses a mathematical algorithm based on number of data points to calculate values for W and MG. Bar Builder II still uses this algorithm for a single data set. (I've moved the algorithm from lines 3180 through 3230 to 12450 through 12490 to keep similarly functioning parts of the program together.)

For graphs containing two, three, or four data sets, however, it's easier to simply anticipate every situation, since there are considerably fewer cases to handle. A new Bar Builder II subroutine (lines 300 through 390) gives the MG and W arrays the data they need for each combination of number of sets and data elements. For example, the program reads the first two DATA elements, 17 and 4, into MG(1,2) and

Program listing. Bar Builder II.

```
5 REM
6 REM *****
7 REM BAR BUILDER
8 REM MAIN PROGRAM
9 REM *****
10 TEXT : HOME
20 GOSUB 10000: IF N = 0 THEN 90
25 GOSUB 1300
30 GOSUB 12300: GOSUB 12500
40 INPUT "CONTINUE <C> OR END <E>...";X$
50 IF X$ < > "C" AND X$ < > "E" THEN 40
60 IF X$ = "E" THEN 90
70 TEXT : HOME : GOSUB 1200
80 GOTO 30
90 TEXT : HOME : END
95 REM
96 REM *****
97 REM VARIABLE INITIALIZATION
98 REM *****
```

Listing continued.

W(1,2). If you're plotting only one data point for two sets, the left margin will be 17 columns wide, and each bar will be four columns wide.

The fourth new array, MX(i), contains the maximum number of data elements allowed for each of the four combinations of data sets. These values are assigned in line 160. The graph can handle 38 data points for a single set (or two sets plotted as alternating points in the single-set mode), ten data points per set for two data sets, eight points for each of three sets, and six points for each of four sets.

Running the Revised Program

When you execute Bar Builder II, the program first asks you to type in the number of data sets you want to plot. Bar Builder II stores this value in the variable S. It then asks you to type in the number of data elements in the largest set, which it stores in N. After that, it prompts you to type in data elements; you must enter the first element for each set before proceeding to the second element. This is the same order in which the bars will appear in the graph, from left to right. If it's easier to type in your data one complete set at a time, simply reverse lines 12020 and 12030, and change line 12060 to read NEXT I,J.

The next item Bar Builder II asks you to type in is a value (or zero) it will subtract from every data element in each given set. As I explained last month, this lets you "zoom in" on the upper regions of the bars to study variations among data points in a specific set. It also lets you compare variations within each of two data sets having values that are very different from each other on the same graph. For example, suppose you'd like to see if the market fluctuations that occurred in your favorite penny stock also affected IBM stock. Reducing all data points for the IBM figures by, say, 130, would let both sets show up on the same graph.

Some applications may require you to multiply or divide rather than subtract all elements of a given set by a common factor. If that's the case, simply change the minus signs in lines 12310 and 12360 to the appropriate symbols. You'll also have to change the operation in line 1220 (now addition) to the appropriate operation that reverses the one you chose for lines 12310 and 12360. A multiplication or division factor changes the overall size of each entry

by an amount relative to its original size. This, in effect, magnifies or reduces the entire bar rather than magnifying just the top portion.

Finally, Bar Builder II lets you change any entry to correct typos or edit. Then the program normalizes all the data so that they'll fit into the vertical display space, and puts the graph on screen. When you're finished viewing the graph, you'll have another opportunity to change any element (including the subtraction factors, which the program stores in element zero of each set) and redisplay the graph. Bar Builder II automatically readjusts all data elements to their original values (lines 1200 through 1240) before letting you make changes in your graph, so that the additional step I described in the original Bar Builder is unnecessary.

Overlapping the Bars

When bars are lined up side by side, as in the case of a single data set, all you need is Applesoft's VLIN a,b AT c function, which draws a vertical line in column c between rows a and b inclusive. To make the bars overlap, however, you have to take a different approach.

Bar Builder II uses the VLIN function to draw the bars for elements from the first data set that appear in the foreground of the graph. Bars for elements from the second set appear to be located behind and just to the right of the first set's bars. The accompanying **Figure** illustrates this effect for a graph with four data elements in each of three sets. You can use VLIN for sets 2 through 4 only for those parts of the bars that appear in their entirety.

Figure. Simulated screen display for Bar Builder II with three data sets of four data elements each.

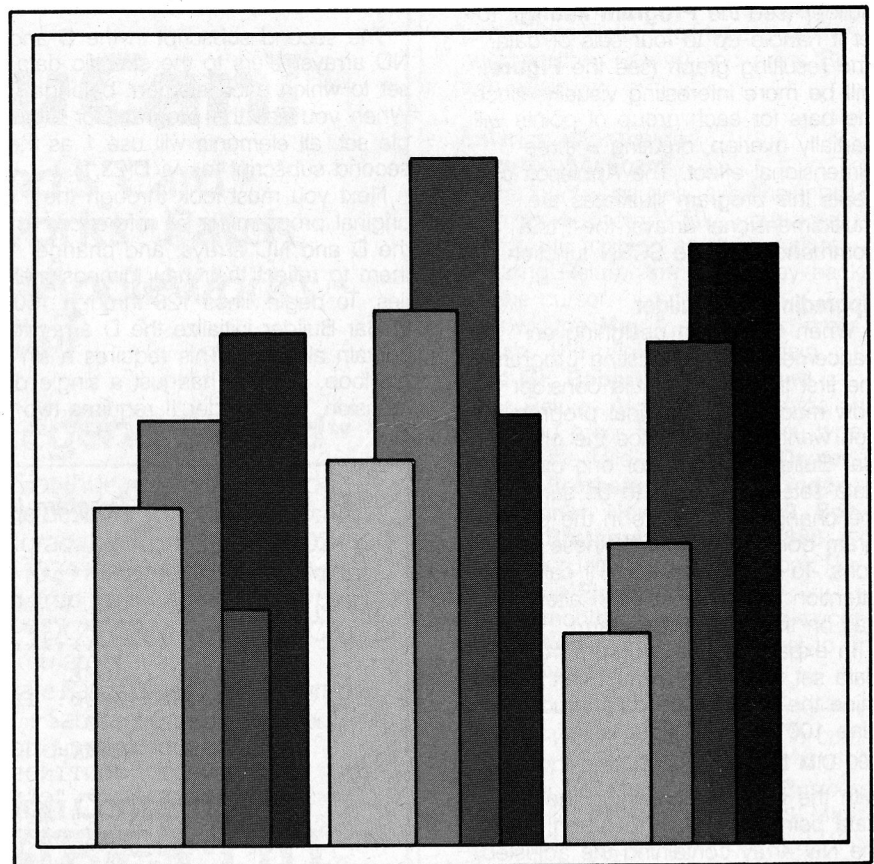

PORTFOLIO PERFORMANCE: 82-84
PRESS (C) TO CONTINUE; (E) TO END...

To draw the upper part of a bar that disappears behind its neighbor to the left, Bar Builder II uses the PLOT c,r command instead of the VLIN command. The PLOT c,r function produces only a single point in the currently defined color at column c, row r, so you must use it in a loop to create a line. The command VLIN 12,38 AT 3 has exactly the same effect as the following series of commands:

```
100 FOR I = 12 TO 38
110 PLOT 3, I
120 NEXT I
```

Lines 12650 through 12680 handle the plotting loop. With the PLOT command, you have total control over whether or not the program will plot a point in the proposed line. And if another bar already occupies the location for a point to be plotted, Bar Builder II immediately terminates the loop. So if the program draws the bars top to bottom, it will plot points only until it encounters the top of a previously plotted bar.

To make this determination, AppleSoft includes the SCRN function.

SCRN(x,y) returns the color code of the point at column x, row y on the display screen. If that point is black, the color code is zero. Before using the PLOT command to PLOT P,L (line 12670), Bar Builder II tests to be sure the point is black.

The following line ends the loop if the program encounters a previously drawn bar:

```
12660 IF SCRN(P,L) <> 0 THEN L =
      38:GOTO 12680
```

Conclusion

As you look over Bar Builder II, you may note that the D and ND arrays contain a number of vacant elements. This results from dimensioning them to allow for a single data set with several elements as well as for multiple data sets. In fact, the data for four complete graphs could easily fit into the defined arrays with room to spare. Try your hand at expanding the program to accommodate data entry for up to four graphs without changing the dimensions of the D and ND arrays. Your program should let you select any of the four graphs for display, and correct any data element in memory by specifying the graph, the data set in that graph, and the specific element in the data set you'd like to change. ■

Listing continued.

```
99 REM
100 DIM D(40,4),ND(40,4),T$(3),W(10,4),MG(10,4),C(4),MX(4)
110 C(1) = 5:C(3) = 13
120 C(2) = 12:C(4) = 1
130 FOR I = 0 TO 40
135 FOR J = 0 TO 4
140 D(I,J) = 0:ND(I,J) = 0
150 NEXT J,I
160 MX(1) = 38:MX(2) = 10:MX(3) = 8:MX(4) = 6
170 RETURN
195 REM
196 REM *****
197 REM INVALID ENTRY RESPONSE
198 REM *****
199 REM
200 PRINT : PRINT "INVALID ENTRY. "
210 INPUT "PRESS <RETURN> TO CONTINUE...";X$
220 RETURN
295 REM
296 REM *****
297 REM MARGINS & BAR WIDTH
298 REM *****
299 REM
300 FOR J = 2 TO 4
310 FOR I = 1 TO 10
320 READ MG(I,J)
330 READ W(I,J)
340 NEXT I
350 NEXT J
360 DATA 17,4,13,4,10,4,6,4,2,4,5,3,2,3,0,3,2,2,0,2
370 DATA 16,4,11,4,6,4,2,4,5,3,2,3,2,2,0,2,0,0,0,0
380 DATA 15,4,9,4,3,4,6,3,2,3,2,2,0,0,0,0,0,0,0,0
390 RETURN
1195 REM
1196 REM *****
1197 REM DATA ENTRY CORRECTION
1198 REM *****
1199 REM
1200 FOR J = 1 TO S
1210 FOR I = 1 TO N
1220 D(I,J) = D(I,J) + D(0,J)
1230 NEXT I
1240 NEXT J
1300 PRINT "-----"
1310 PRINT "DO YOU WISH TO CHANGE ANY DATA ENTRIES?"
1320 INPUT "(Y/N)...";X$
1330 IF X$ < > "Y" AND X$ < > "N" THEN GOSUB 200: GOTO 13
00
1340 IF X$ = "N" THEN 1390
1345 PRINT : INPUT "WHICH DATA SET...";ES
1346 IF ES < 1 OR ES > S THEN 1345
1350 INPUT "WHICH ENTRY NUMBER...";EN
1351 IF EN < 0 OR EN > N THEN 1350
1360 PRINT "ENTRY "EN" IN SET "ES" IS "D(EN,ES)".
1370 INPUT "WHAT VALUE SHOULD IT HAVE? ";NV
1380 D(EN,ES) = NV: GOTO 1300
1390 RETURN
2995 REM
2996 REM *****
2997 REM BLUE GRAPH BORDER
2998 REM *****
2999 REM
3000 GR : CALL - 1994
3010 COLOR= 2
3020 VLIN 0,39 AT 0
3030 VLIN 0,39 AT 39
3040 HLIN 0,39 AT 0
3050 HLIN 0,39 AT 39
```

Write to Dan Bishop at 4124 Beaver Creek Drive, Fort Collins, CO 80526.

inCider

Listing continued.

THE SMART WAY TO SAVE YOUR *inCider*

You'll find all your favorite issues of **inCider** in minutes—and in great condition with smart-looking binders or file cases from Jesse Jones.

Sturdy, protective file cases make for easy access to each issue, while rugged binders allow magazines to lay flat for easy reference. Both hold 12 issues, are custom-designed in green with gold spine lettering, and are **unconditionally guaranteed**.

Order today!

File Cases: \$6.95 ea.; 3/\$20; 6/\$36.

Binders: \$8.50 ea.; 3/\$24.75; 6/\$48.



Yes! Please send me protection for my **inCider**:

_____ File Cases _____ Binders

I enclose my check or money order for \$ _____

Name _____

Address _____

City _____ State _____ Zip _____

US currency only.

Outside US, add \$2.50 per item for postage and handling.
Please allow 4-6 weeks for delivery.

MAIL TO: Jesse Jones Box Corp., PO Box 5120,
Dept. INCID, Philadelphia, PA 19141

Listing continued.

```

3060 RETURN
3495 REM
3496 REM *****
3497 REM PLOTTER FOR SETS=1
3498 REM *****
3499 REM
3500 HOME
3510 C0 = C(1)
3520 GOSUB 3000
3530 FOR H = 1 TO N: COLOR= C0
3540 FOR LW = 1 TO W
3550 IF ND(H,1) = 0 THEN LW = W: GOTO 3570
3560 VLIN 39 - ND(H,1),38 AT MG + W * (H - 1) + (LW - 1)
3570 NEXT LW
3580 IF C0 = C(1) THEN C0 = C(2): GOTO 3600
3590 C0 = C(1)
3600 NEXT H
3610 HOME
3620 PRINT T$(1)
3630 PRINT T$(2)
3640 PRINT T$(3)
3650 RETURN
9995 REM
9996 REM *****
9997 REM GET NO. OF DATA SETS
9998 REM *****
9999 REM
10000 HOME : PRINT
10010 PRINT "*****"
10020 PRINT " BAR BUILDER II"
10030 PRINT "*****"
10040 GOSUB 100: GOSUB 300: PRINT
10050 PRINT "HOW MANY SETS OF DATA (1-4) DO YOU"
10060 PRINT "WISH TO PLOT SIMULTANEOUSLY? ";
10070 INPUT " ":S
10080 IF S < 1 OR S > 4 THEN GOSUB 200: GOTO 10000
10090 PRINT : PRINT "HOW MANY DATA POINTS IN YOUR LARGEST"
10100 PRINT "SET (1-";MX(S);". ENTER 0 TO END)...";
10110 INPUT " ";N
10120 IF N < 0 OR N > MX(S) THEN GOSUB 200: GOTO 10090
10130 IF N = 0 THEN RETURN
10140 PRINT
10150 FOR T = 1 TO 3
10160 PRINT "ENTER TEXT LINE #\"T\": "
10170 INPUT " ";T$(T)
10180 PRINT
10190 NEXT T
11995 REM
11996 REM *****
11997 REM DATA ELEMENT ENTRY
11998 REM *****
11999 REM
12000 PRINT
12010 PRINT
12020 FOR I = 1 TO N
12030 FOR J = 1 TO S
12040 PRINT "DATA POINT #\"I\" FOR SET \"J\": ";
12050 INPUT " ";D(I,J)
12060 NEXT J,I
12070 PRINT
12080 FOR J = 1 TO S
12090 PRINT "WHAT COMMON VALUE (OR 0) IS TO BE SUB-\"
12100 PRINT "TRACTED FROM EACH VALUE IN DATA SET \"J\": "
";
12110 INPUT " ";D(0,J)
12120 PRINT
12130 NEXT J
12140 PRINT "THESE VALUES WILL BE STORED IN ELEMENT ZERO
OF EACH SET."
    
```

Listing continued.

Listing continued.

```
12150 RETURN
12295 REM
12296 REM *****
12297 REM NORMALIZE DATA INTO ND
12298 REM *****
12299 REM
12300 FOR J = 1 TO S
12310 D(1,J) = D(1,J) - D(0,J)
12320 D(40,J) = D(1,J)
12330 NEXT J:HV = 0
12340 FOR J = 1 TO S
12350 FOR I = 2 TO N
12360 D(I,J) = D(I,J) - D(0,J)
12370 IF D(I,J) > D(40,J) THEN D(40,J) = D(I,J)
12380 NEXT I
12390 IF D(40,J) > HV THEN HV = D(40,J)
12400 NEXT J
12405 NF = 37 / HV
12410 FOR J = 1 TO S
12415 FOR I = 1 TO N
12420 ND(I,J) = INT (D(I,J) * NF)
12425 NEXT I,J
12430 IF S = 1 THEN GOTO 12450
12435 W = W(N,S)
12440 MG = MG(N,S)
12445 GOTO 12490
12450 W = 1
12455 IF N < 20 THEN W = 2
12460 IF N < 13 THEN W = 3
12465 MG = INT ((38 - N * W) / 2)
12470 IF MG < 1 THEN MG = 1
12490 RETURN
12495 REM
12496 REM *****
12497 REM PLOTTER FOR SETS=2 TO 4
12498 REM *****
12499 REM
12500 IF S = 1 THEN GOTO 3500
12510 HOME : GOSUB 3000
12520 P = MG
12530 FOR H = 1 TO N
12540 FOR J = 1 TO S: COLOR= C(J)
12550 IF J > 1 THEN 12600
12560 FOR LW = 1 TO W
12570 IF ND(H,J) = 0 THEN LW = W: GOTO 12590
12580 VLIN 39 - ND(H,J),38 AT P + (LW - 1)
12590 NEXT LW:P = P + W: GOTO 12720
12600 IF W = 2 THEN P = P - 1
12610 IF W > 2 THEN P = P - 2
12615 IF ND(H,J) = 0 THEN P = P + W: GOTO 12720
12620 T = 39 - ND(H,J)
12630 LW = 1: IF W > 2 THEN LW = 2
12640 FOR K = 1 TO LW
12650 FOR L = T TO 38
12660 IF SCRN( P,L) < > 0 THEN L = 38: GOTO 12680
12670 PLOT P,L
12680 NEXT L
12690 P = P + 1: NEXT K
12700 VLIN T,38 AT P:P = P + 1
12710 IF W > 3 THEN VLIN T,38 AT P:P = P + 1
12720 NEXT J
12730 P = P + 1
12740 NEXT H
12750 HOME
12760 PRINT T$(1)
12770 PRINT T$(2)
12780 PRINT T$(3)
12790 RETURN
```

End of listing.

NEW!

The Diversified Accountant™ Job Cost System

The Best By Far - The Diversified Accountant is by far the fastest, most powerful, and easiest to use Job Cost System on the market.

High Capacity - Handles 1,000 active jobs, 200 work codes, and 845 vendors or employees. Holds 380,000 data entries on a 10-meg hard disk, or 3,000 entries on a floppy disk.

Optimized Data Entry - Accepts data as fast as you can type. Skilled operators can enter a complete transaction in less than 10 seconds.

Highly Flexible Reports - Unique data selection/computation process lets you find virtually anything you want to know about your actual and estimated costs.

Incredibly Fast - Using Pascal and optimized Machine Language, The Diversified Accountant can usually compute a report faster than your printer can print it.

Programmer Supported - Mail and telephone support is available from Bill Basham. We will notify you of all major updates, which you can buy for \$5.

Try it First - Our \$5 demo disk is an actual working copy of the program. We believe that the best way to sell a program this good, is to put it in your hands. Check it out!

BUY THE BEST BY FAR BUY DSR

- Diversi-DOS™** \$30
DOS 3.3 enhancement
- Diversi-COPY™** \$30
Hi-speed disk back-up/format
- Diversified Accountant™** \$475
Job Cost System
- Demonstration Disk \$5
- Diversi-DIAL™** \$475
7-line C.B.-simulator
- Demonstration Disk \$5

24-Hour Toll-Free Ordering

800 835-2246 ext. 127 (orders only)

For information call 313 553-9460

300-Baud Modem call 313 553-4466

FREE: Dogfight II arcade game included with Diversi-DOS and Diversi-COPY

All programs work on Apple //e, //c or 64K Apple II+ compatible computers.

Sold by Mail-Order Only. Price includes 1st class or foreign airmail.

C.O.D., Visa/Mastercard (Include Exp. Date)
Personal Check, Purchase Orders accepted

Diversified Software Research, Inc.
34880 Bunker Hill
Farmington, MI 48018-2728 

PASCAL PRIMER

Pascal Sets

by Tom Swan

The most astonishing characteristic of Pascal sets is that, no matter how much you put into them, they never grow larger. A set of one or two items often takes the same amount of memory as a set containing hundreds of items. How to create and use these magically efficient data types is the subject for this month.

Declaring Set Variables

To create a set variable, use the keywords SET OF and a data type in a Variable or Type declaration. The following defines variable ASCIISet as a set of characters:

```
VAR
  ASCIISet : SET OF Char;
```

A better approach, as with other Pascal structures, is to declare a new type first, then create variables of that type. For example:

```
TYPE
  CharSet : SET OF Char;
VAR
  Digits, Letters : CharSet;
```

Once you define the new data type, you can create as many CharSet variables as you want. Just separate each variable with commas as shown above.

You can also pass character sets to procedures and functions. To do that, use the new type identifier in a parameter list. As an example, the function in **Listing 1** takes a character-set

Learn how to create data sets for efficient Pascal programming.

parameter GoodChars and returns a single character.

The GoodChars parameter defines the set of characters the function can return. The Boolean expression (ch IN GoodChars) is True only if Pascal finds ch in the GoodChars set. IN, Pascal's *set-membership* operator, tests to see if a set variable contains a specific element—in this case, the character in ch. If GoodChars equals the set of characters ['A','B','C'] and you type D, GetChar writes chr(7)—the control character that causes the Apple speaker to beep—to indicate an error. If you type A, B, or C, the function returns that character and the program continues.

You can use the GetChar function any time you want a user to type a specific set of characters. A common example is prompting for one of several menu selections. If you want someone to type E to edit, P to print, and Q to quit, you could write:

```
Write( 'E(edit P(rint Q(uit: ' );
Ch := GetChar( [ 'E', 'P', 'Q' ] );
```

Assigning Values to Sets

To assign a list of elements to a set variable, enclose the elements in

square brackets. The order of elements is unimportant. The statement below assigns digit characters to the Digits set variable:

```
Digits := [ '0' .. '9' ];
```

The two-period ellipsis indicates a subrange between two constants. This shorthand lets you avoid writing the equivalent statement below:

```
Digits := [ '0', '1', '2', '3', '4',
           '5', '6', '7', '8', '9' ];
```

Notice that the digits are characters, not numbers.

If you want a set of integer values, you would first declare a set variable this way:

```
VAR
  TenSet : SET OF 0 .. 9;
```

then assign the *values* zero to nine to the set variable:

```
TenSet := [ 0 .. 9 ];
```

Set Limitations

Set elements must be simple, scalar data types. A scalar type is one whose elements fall into whole-number steps. Integers, characters, and Boolean true/false values are scalar. Real numbers, because they're infinitely divisible, are not scalar. Unlike mathematics, therefore, Pascal cannot have real-number sets. The same restriction applies to structured data types: Records, strings, and arrays cannot be elements of Pascal sets.

Apple Pascal further restricts sets to a maximum of 512 elements. Other Pascal compilers impose different limits on the number of set elements you can have—a fact worth remembering if you want your programs to compile on other computers. One notable example, Turbo Pascal, which requires a CP/M card, limits you to 256 elements, half the number Apple Pascal permits.

Internally, single bits represent individual set elements. Because of this, set variables take up memory space according to the formula below:

Listing 1. Function that returns a single character from character-set parameter GoodChars.

```
FUNCTION GetChar( GoodChars : CharSet ) : Char;
VAR ch : char; Okay : Boolean;
BEGIN
  REPEAT
    Read( Keyboard, ch );
    Okay := ( ch IN GoodChars );
    IF NOT Okay THEN Write( chr(7) );
  UNTIL Okay;
  GetChar := ch;
END; (* GetChar *)
```

$2 * (1 + ((n - 1) \text{DIV } 16))$

N equals the maximum number of elements a set can have. Therefore, a set of up to 32 elements takes 4 bytes no matter how many elements it actually contains. A set of up to 48 elements takes 6 bytes, and a set using the maximum of 512 elements takes 64 bytes.

Prompting for Commands

Prompting for one of several commands is a common program operation. Because this is something you'll frequently need to do, a standard procedure in all your programs will save you time.

Listing 2, CommandTest, shows how to write this procedure with sets. GetCommand in line 18 displays a prompt message at the bottom of the screen and returns a character in parameter Command. Similar to the earlier GetChar function, GetCommand limits characters to those passed in the character-set parameter, CommandSet.

Line 44 uses a different method to assign a character set. Instead of literal characters like 'A' and 'C', the assignment uses the built-in chr() function to convert ASCII values to character data types. You could rewrite the line as shown below:

```
VisibleChars := [ ' . , ~ ' ];
```

Not all Apple keyboards have a tilde (~) key, however. If you plan to publish your programs for others to type in, remember there are those who still have older (or should I say "more mature"?) Apple II's.

Another example of how to insert unusual characters in sets appears in line 13, which tests ch for membership in the set of lowercase letters. (Not long ago, a similar group of statements forced me into a few late-night editing sessions while I was finishing my first two Pascal books. I remembered almost too late that not all Apple keyboards can produce lowercase letters!)

Another function, UpCase (lines 10–16), finds its way into most of my programs. It's especially handy at times when you don't want to distinguish between upper- or lowercase letters, as in lines 27–28 where any character you type is immediately converted to uppercase.

When you run the program, notice how the FOR loop at lines 36–37 displays the set of expected characters. Try making mistakes—type a letter when the program asks for a digit—to see the FOR loop in action.

Other Kinds of Sets

Besides characters and digits, you can create sets of other data types. In combination with an enumerated data type of your own creation, you can often use sets to write programs that are almost entirely composed of English words. **Listing 3**, States, demonstrates how to use sets this way to increase the readability of your programs. The entire 80-line program has only six literal values, three of which are zero and one.

Before typing in and running the program, create a text file with the names of the 50 states. Type each state name on a separate line in the same order as listed in lines 3–12. Save this file as STATE.TEXT. The program reads it in lines 32–34 to initialize the StateNames array.

The enumerated State data type at line 3 shows how to create your own enumerated, scalar types in Pascal. Enumerated data types take the form:

```
<identifier> = ( Value1, Value2, ..., Valuen )
```

where Value_i through Value_n are the names of the elements you want to declare.

In States, the elements are state names. In another program, they could be colors, planets, species—anything with a list of elements you can name, up to 512 items. The elements are called enumerated types because the Pascal compiler translates them into numbers.

The identifiers—in this example, the state names—are conveniences for your sake. In the compiled program, those same identifiers are simple numbers. After compiling, Alabama

Listing 2. COMMANDTEST.

```
0: PROGRAM CommandTest;
1: CONST
2:   ClrEoln = 29; (* ASCII value to clear to end of line *)
3:   Prompt = 'TEST: D.igit, L.etter, Q.uit';
4: TYPE
5:   CharSet = SET OF Char;
6: VAR
7:   TestCh, Command : Char;
8:   DigitSet, LetterSet, VisibleChars : CharSet;
9:
10: FUNCTION UpCase( ch : char ) : char;
11: (* Convert lowercase chars to uppercase *)
12: BEGIN
13:   IF ch IN [ chr(97) .. chr(122) ] (* [ 'a' .. 'z' ] *)
14:   THEN UpCase := chr( ord(ch) - 32 )
15:   ELSE UpCase := ch
16: END; (* UpCase *)
17:
18: PROCEDURE GetCommand( Prompt : string;
19:   CommandSet : CharSet;
20:   VAR Command : Char );
21: (* Prompt for and return Command from CommandSet *)
22: VAR
23:   CommandIsGood : Boolean; ch : char;
24: BEGIN
25:   REPEAT
26:     Gotoxy( 0, 22 ); Write( Chr( ClrEoln ), Prompt, ':' );
27:     Read( Keyboard, Command );
28:     Command := UpCase( Command );
29:     IF Command IN VisibleChars
30:     THEN Writeln( Command )
31:     ELSE Writeln( '<CTRL>' );
32:     CommandIsGood := Command IN CommandSet;
33:     IF NOT CommandIsGood THEN
34:     BEGIN
35:       Write( 'please type: ' );
36:       FOR ch := chr(32) TO chr(127) DO
37:         IF ch IN CommandSet THEN Write( ch:2 )
38:         END (* if *)
39:     UNTIL CommandIsGood;
40:     Page( Output ) (* Clear screen *)
41:   END; (* GetCommand *)
42:
43: BEGIN
44:   VisibleChars := [ chr(32) .. chr(126) ];
45:   LetterSet := [ 'A' .. 'Z' ];
46:   DigitSet := [ '0' .. '9' ];
47:   REPEAT
48:     GetCommand( Prompt, [ 'D', 'L', 'Q' ], Command );
49:     IF Command = 'D'
50:     THEN GetCommand( 'Enter a digit', DigitSet, TestCh ) ELSE
51:     IF Command = 'L'
52:     THEN GetCommand( 'Enter a letter', LetterSet, TestCh )
53:     UNTIL Command = 'Q'
54:   END.
```

Listing 3. STATES.

```

0: PROGRAM States;
1:
2: TYPE
3:   State = ( Alabama, Alaska, Arizona, Arkansas, California,
4:             Colorado, Connecticut, Delaware, Florida, Georgia,
5:             Hawaii, Idaho, Illinois, Indiana, Iowa,
6:             Kansas, Kentucky, Louisiana, Maine, Maryland,
7:             Massachusetts, Michigan, Minnesota, Mississippi, Missouri,
8:             Montana, Nebraska, Nevada, NewHampshire, NewJersey,
9:             NewMexico, NewYork, NorthCarolina, NorthDakota, Ohio,
10:            Oklahoma, Oregon, Pennsylvania, RhodeIsland, SouthCarolina,
11:            SouthDakota, Tennessee, Texas, Utah, Vermont,
12:            Virginia, Washington, WestVirginia, Wisconsin, Wyoming );
13:
14:   StateSet = SET OF State;
15:
16:   NameArray = ARRAY[ State ] OF String[15];
17:
18: VAR
19:   StateNames : NameArray;
20:   CoastalStates,
21:   LandLockedStates,
22:   GreatLakeStates : StateSet;
23:
24: PROCEDURE Initialize;
25: CONST
26:   FileName = 'STATES.TEXT'; (* Each state on a separate line *)
27: VAR
28:   TextFile : TEXT;
29:   OneState : State;
30: BEGIN
31:   Writeln( 'Reading ', FileName );
32:   reset( TextFile, FileName );
33:   FOR OneState := Alabama TO Wyoming DO
34:     Readln( TextFile, StateNames[ OneState ] );
35:
36:   CoastalStates := [ Washington, Oregon, California, Texas,
37:                     Louisiana, Mississippi, Alabama, Florida,
38:                     Georgia, SouthCarolina, NorthCarolina,
39:                     Maryland, Virginia, Delaware, NewJersey,
40:                     NewYork, Connecticut, Massachusetts,
41:                     RhodeIsland, NewHampshire, Maine ];
42:
43:   GreatLakeStates := [ Minnesota, Wisconsin, Illinois, Indiana,
44:                       Michigan, Ohio, Pennsylvania, NewYork ];
45:
46:   LandLockedStates := [ Alabama .. Wyoming ] -
47:                       ( CoastalStates + GreatLakeStates )
48:
49: END; (* Initialize *)
50:
51: PROCEDURE List( s : string; VAR StateList : StateSet );
52: VAR
53:   OneState : State;
54:   Column : integer;
55: BEGIN
56:   Writeln;
57:   Writeln( s, ' STATES:' );
58:   Column := 0;
59:   FOR OneState := Alabama TO Wyoming DO
60:     BEGIN
61:       IF Column >= 4 THEN
62:         BEGIN
63:           Writeln; Column := 0;
64:         END; (* if *)
65:       IF OneState IN StateList THEN
66:         BEGIN
67:           Write( StateNames[ OneState ]:18 );
68:           Column := Column + 1;
69:         END (* if *)
70:     END; (* for *)
71:   Writeln
72: END; (* List *)
73:
74: BEGIN
75:   Initialize;
76:   List( 'COASTAL', CoastalStates );
77:   List( 'GREAT LAKE', GreatLakeStates );
78:   List( 'LAND-LOCKED', LandLockedStates )
79: END.

```

becomes zero, Alaska one, and Wyoming 49—the names no longer exist. But your program can ignore this technical fact and use the more descriptive names instead.

Line 14 declares variable StateSet as a set of the enumerated State data type. StateSet can therefore hold any combination of states from Alabama to Wyoming.

The program uses this idea to assign groups of states to three set variables—CoastalStates, LandLockedStates, and GreatLakeStates. It initializes the three set variables in lines 36–47, then displays those states bordering ocean water, the Great Lakes, and other states. As with character sets, individual set elements are separated by commas and surrounded by square brackets.

Set Operators

The relational inclusion operators, \leq and \geq , test whether one set is a subset of another. The following expressions are both true:

```
['A','Z'] <= ['A'..'Z']
```

and

```
GreatLakeStates >=
  [Ohio,Pennsylvania,NewYork]
```

The first expression says that the two-character set A,Z is a subset of the letters A through Z. The second expression states that GreatLakeStates is a superset of the three-state set shown. To better remember how to use these operators, you can pronounce \leq as “is a subset of” and \geq as “has the subset.”

You can also compare two sets for equality with the usual operators, = and $\langle \rangle$. Consequently, the following statements are true:

```
['A','B','C'] <> ['D','E','F']
```

and

```
[1, 2, 3, 4] = [4, 2, 3, 1]
```

In the second expression, the order is different, but the sets are equivalent. The ordering of elements in a set never affects the set's value.

Three other operators combine two or more sets according to the rules in the **Table**. Set union is similar to addition. The result of SetA + SetB is a set containing all the elements of both SetA and SetB.

Set difference resembles subtraction. SetA - SetB results in a set with all the elements of SetB taken away from SetA—if those elements were in SetA to begin with.

The third operator, set intersection, combines the common elements of

Table. Set operators.

Operator	Rule
+	Set union
-	Set difference
*	Set intersection

two sets. The expression SetA * SetB produces a set whose elements are found in both original sets.

Listing 3 uses the union and difference operators (lines 46-47) to calculate the set of LandLockedStates. This set is equivalent to the difference between all the states and the union of the CoastalStates and GreatLakeStates sets.

Pascal News

New products include a Duplicate bridge-scoring program from Hampton Mulligan, 1799 Tularosa Road, Lompoc, CA 93436. Not being a bridge player, I cannot give Hampton's program a fair review, but if you're in a Duplicate club, you might want to write for more information.

I also received several programs from DogStar Software, P.O. Box 302, Bloomington, IN 47402. DogStar sells a text editor, monitor, and various other utilities written to operate under the Apple Pascal operating system. One caution about DogStar products: They appear to write directly to the Apple screen memory and, therefore, will not work with external terminals. I had to remove my serial card from slot 3 to get them to run.

And Finally. . .

Pascal sets are useful in a variety of situations. Character sets are particularly good for limiting responses to specific keys. Other sets may be combined or tested using one of several set operators. Because single memory bits represent set elements, set variables are extremely efficient and can store hundreds of items without changing size.

In my next column, I'll turn to a subject that seems to perplex many people—pointers. ■

Tom Swan is the author of the Apple Pascal series, Pascal Programs for Business, Pascal Programs for Games and Graphics, and Pascal Programs for Data Base Management, published by Hayden Book Company. Address correspondence to Tom at P.O. Box 206, Lititz, PA 17543. Please enclose a self-addressed, stamped envelope if you want a personal reply.

inCider

MODEM MGR™

\$49⁹⁰

plus \$3 ship/hand
plus tax (Calif. only)

- A new modem communications program
- For Apple II +, IIc, IIe, enhanced IIe
- Both DOS 3.3 and ProDOS support
- Supports most serial and modem cards
- Supports most smart and non-smart modems
- Fast operation (110 to 19200 baud)
- Text capture and auto disk-save
- Screen capture (snapshot)
- Full-screen editor
- Full- or split-screen display with block send (for CB, chat, packet radio)
- Macro script files for auto log-on
- Programmable function keys
- XMODEM error-free file transfer
- Supports Apple or Videx 80-column card
- On-screen time-of-day or elapsed-time display (with some clock cards)
- Unattended mode with password protection
- Emulates DEC VT-52, DG D200, others
- Supports most printer cards
- Choice of carrier or "smart" modem control
- Not copy-protected
- Available direct only. Send check to:

**MGR
SOFTWARE**

Suite 101
305 So. State College Blvd.
Anaheim, CA 92806
(714) 993-0294

Apple, ProDOS are trademarks of Apple Computer Inc.

Circle 251 on Reader Service Card.

NOTICE

Have FUN as a League Secretary Let your Apple Computer do the work BOWL-KEEPER II

\$49.95 + \$3.00 S/H (FL residents add sales tax)

Bowl-Keeper II is a league secretary's Data Base Manager. All you do is enter the scores. It does all the calculations, sorts and archives all data for 100 bowlers and 50 teams for 36 weeks. Double check the re-cap sheets with Bowl-Keeper II. Full edit capability. Maintain as many Scratch or handicap leagues as you wish.

For bowlers, **Bowl-Keeper II** calculates weekly average, running average, weekly series, handicap, total pins, sorts bowlers from high to low average, sorts for high scratch and handicap game and series for each bowler, and sorts high scratch and handicap games and series for the entire league. Archives each bowler.

For teams, **Bowl-Keeper II** calculates scratch weekly series, handicap weekly series, handicap, total pins, total games, total won/lost, team average, percentage wins, sorts teams from high to low based on won/lost and total pins, sorts each team high game and series, league scratch and handicap high games and series. Archives each team.

BOWL-KEEPER II STANDING SHEET

\$39.95 + \$3.00 S/H (FL residents add sales tax)

Bowl-Keeper II Standing Sheet uses the data generated by Bowl-Keeper II and produces the standard ABC/WIBC standing sheet. Ten bowlers allowed for each team. Full edit capability. Scratch or handicap leagues. Standard, legal or continuous paper. most printers supported.

Requires Apple* II, II+, IIe, with 48K of memory, one disc drive and printer
To order send check or money order to **CLAYTON & ASSOCIATES, INC.**
P.O. BOX 6361, Clearwater, Florida 33518
C.O.D. ORDERS (813) 797-7815

*Apple is a trademark of Apple Computer Inc. Program description available on request

Circle 103 on Reader Service Card.

NUTRAHELP

*Are your meals nutritious?
Find out with the help of this
easy-to-use food-analysis program.*

by Vincent D. O'Connor

How would you like to type in a recipe and get back the same kind of nutritional information you find on packaged food at your local grocery? NutraHelp (see the **Program listing**) gives you the number of calories and the amount of sodium, fiber, fat, protein, and carbohydrates in each serving.

To use the program, type in the number of servings and the number of ingredients for each recipe, along with the measurements used and the number of those units for each ingredient. (Don't list spices, because their nutritional value is minimal, but don't forget to include sugars.) If an item is canned, fresh, or frozen, you must type in that information before the ingredient—for example, FROZEN PEAS TABLESPOON 8. All entries must be in capital letters.

If NutraHelp can't locate in its data base one or more of the items listed in your recipe, it warns you that the nutritional value per serving it comes up with is based only on the ingredients it found. You can add ingredients to the program at line 2000, but they must be in alphabetical order. You must list each new item with the ingredient first, followed by the number of calories, the amount of sodium in milligrams, the amount of fat, fiber, protein, and carbohydrates in grams, and the unit of measure. Also, change the variable DI in line 5—the number of ingredients for which the program has nutritional data—to reflect the new total.

NutraHelp also converts measurements for you. If you type in cups, for example, the program automatically converts them to tablespoons. (It can't convert all measurements, though.) For fresh ingredients, like fruit, you must type in EACH as the measurement, followed by an amount such as 1/2 or 2, and so on.

NutraHelp runs under DOS 3.3 or ProDOS. You can make it self-booting by using it as the HELLO program when initializing (INIT) a disk under DOS 3.3, or saving it as STARTUP under ProDOS. ■

Write to Vincent O'Connor at 2607 Hayes NE, Minneapolis, MN 55418.

Program listing. NutraHelp.

```

5 DI = 58
10 HOME : VTAB 2:T# = "NutraHelp": GOSUB 3100
15 VTAB 6:T# = "by": GOSUB 3100: VTAB 10:T# = "Vincent O'Connor": GOSUB 3
100
20 DIM I$(15),C(DI),S(DI),F(DI),FB(DI),P(DI),CB(DI),UN$(DI),IN$(DI),NU$(
(15),AM(15),NA$(15)
25 FOR I = 1 TO DI
30 READ IN$(I),C(I),S(I),F(I),FB(I),P(I),CB(I),UN$(I)
35 NEXT I
40 VTAB 16:T# = "Press <RETURN> to begin": PRINT TAB( (40 + 1 - LEN (
T#) ) / 2)T#:
45 GET A$: IF A# < > CHR$(13) THEN 45
100 F1 = 0: HOME : VTAB 12: PRINT "Number of ingredients (15 MAX)?":
105 GOSUB 1100
110 NI = VAL (A#)
115 PRINT : PRINT "Number of servings (15 MAX)?":
120 GOSUB 1100
125 SV = VAL (A#)
170 FOR I = 1 TO NI
175 HOME : VTAB 10: INPUT "Ingredient: ";I$(I)
180 PRINT : INPUT "Measurement: ";NU$(I)
185 PRINT : INPUT "Amount: ";AM$: GOSUB 1200
190 PRINT : PRINT "Is this correct (Y/N)?":
195 GET A$: IF A# < > "Y" AND A# < > "y" AND A# < > "N" AND A# < >
"n" THEN 195
200 IF A# = "N" OR A# = "n" THEN 175
205 NEXT I
210 HOME : VTAB 10:T# = "CALCULATING NUTRITIONAL VALUE": GOSUB 3100
215 VTAB 12:T# = "OF EACH SERVING": GOSUB 3100: GOSUB 3000
217 IF F1 = 1 THEN GOSUB 1300
220 HOME : VTAB 3:T# = "NUTRITIONAL VALUE PER SERVING": GOSUB 3100
225 PRINT : PRINT N1;" Calories": PRINT N2;" milligrams sodium"
230 PRINT N3;" grams fat": PRINT N4;" grams fiber"
235 PRINT N5;" grams protein": PRINT N6;" grams carbohydrates"
240 PRINT : PRINT "Another Recipe (Y/N)?":
245 GET A$: IF A# < > "Y" AND A# < > "y" AND A# < > "N" AND A# < >
"n" THEN 245
250 IF A# = "Y" OR A# = "y" THEN 100
255 HOME : END
1099 REM GET CHOICE
1100 GET A#
1105 IF A# < "1" OR A# > "9" THEN 1100
1110 PRINT A#:
1115 GET B#
1120 IF B# = CHR$(13) THEN RETURN
1125 IF B# = CHR$(8) THEN PRINT CHR$(8);" "; CHR$(8);: GOTO 1100
1130 IF B# < "0" OR B# > "5" THEN 1115
1135 GET C#
1140 IF C# = CHR$(13) THEN 1155
1145 IF C# = CHR$(8) THEN PRINT CHR$(8);" "; CHR$(8);: GOTO 1115
1150 GOTO 1135
1155 A# = A# + B#: IF VAL (B#) > 15 THEN PRINT CHR$(8); CHR$(8); CHR$(
8);" "; CHR$(8); CHR$(8);: GOTO 1100
1160 RETURN
1200 REM CONVERT FRACTIONS TO DECIMAL
1205 IF AM# = "1/8" THEN AM(I) = .125: RETURN
1210 IF AM# = "1/4" THEN AM(I) = .25: RETURN
1215 IF AM# = "1/3" THEN AM(I) = .33: RETURN
1220 IF AM# = "1/2" THEN AM(I) = .5: RETURN
1225 IF AM# = "2/3" THEN AM(I) = .67: RETURN
1230 IF AM# = "3/4" THEN AM(I) = .75: RETURN
1235 AM(I) = VAL (AM#)
1240 RETURN

```

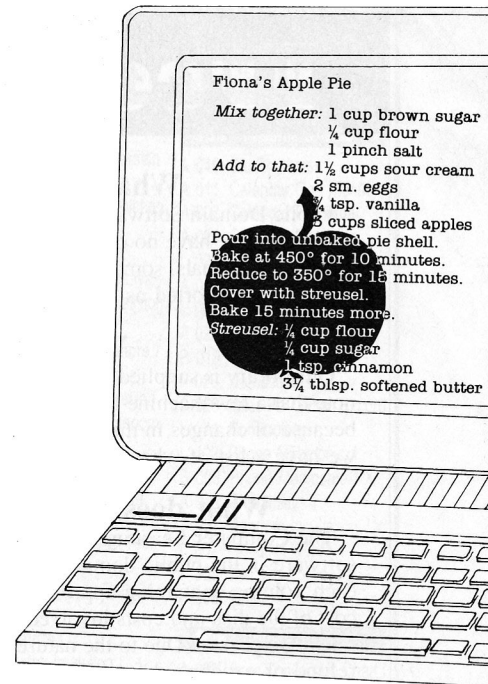

```

1300 HOME : VTAB 2:T# = "WARNING": GOSUB 3100
1305 PRINT : PRINT "The following ingredients in your"
1310 PRINT "recipe do not have nutritional data"
1315 PRINT "available": PRINT
1320 FOR Q = 1 TO NA: HTAB 15: PRINT NA$(Q): NEXT Q
1325 PRINT : PRINT "Press <RETURN> to continue":
1330 GET A#: IF A# < > CHR$(13) THEN 1330
1335 HOME : VTAB 6
1340 PRINT "What follows is the nutritional"
1345 PRINT "value of the recipe based only on those"
1350 PRINT "ingredients with data available."
1355 PRINT : PRINT "Press <RETURN> to continue":
1360 GET A#: IF A# < > CHR$(13) THEN 1360
1365 RETURN
1399 REM      BINARY SEARCH
1400 L = 1:H = DI
1405 M = INT ((H + L) / 2)
1410 IF I$(I) = IN$(M) THEN RETURN
1415 IF L > = H THEN FL = 1: RETURN
1420 IF I$(I) > IN$(M) THEN 1430
1425 H = M - 1: GOTO 1405
1430 L = M + 1: GOTO 1405
1499 REM      CHANGE MEASUREMENTS
1500 IF NU$(I) = "OUNCE" AND UN$(M) = "TABLESPOON" OR (NU$(I) = "PINT"
" AND UN$(M) = "CUP") THEN AM(I) = AM(I) * 2: RETURN
1505 IF NU$(I) = "TABLESPOON" AND UN$(M) = "OUNCE" THEN AM(I) = AM(I) /
2: RETURN
1510 IF NU$(I) = "TEASPOON" AND UN$(M) = "TABLESPOON" THEN AM(I) = AM(I)
) / 3: RETURN
1515 IF NU$(I) = "TABLESPOON" AND UN$(M) = "TEASPOON" THEN AM(I) = AM(I)
) * 3: RETURN
1520 IF NU$(I) = "CUP" AND UN$(M) = "TABLESPOON" THEN AM(I) = AM(I) * 1
6: RETURN
1525 IF NU$(I) = "CUP" AND UN$(M) = "TEASPOON" THEN AM(I) = AM(I) * 48:
RETURN
1530 IF NU$(I) = "TABLESPOON" AND UN$(M) = "CUP" THEN AM(I) = AM(I) / 1
6: RETURN
1535 IF NU$(I) = "TEASPOON" AND UN$(M) = "CUP" THEN AM(I) = (AM(I) / 16
) / 3: RETURN
1540 IF NU$(I) = "TEASPOON" AND UN$(M) = "OUNCE" THEN AM(I) = (AM(I) /
2) / 3: RETURN
1545 IF NU$(I) = "OUNCE" AND UN$(M) = "TEASPOON" THEN AM(I) = (AM(I) *
2) / 3: RETURN
1550 HOME : VTAB 8: PRINT "Please enter the number of ";UN$(M)
1555 PRINT "of ";IN$(M);":": INPUT AM$: GOSUB 1200
1560 RETURN
1565 VTAB 12:T# = "OF EACH SERVING": GOSUB 3000: RETURN
2000 DATA APPLE,80,2,1,1,0,20,EACH
2002 DATA ASPARAGUS,2,5,1,0,1,25,.5,EACH
2004 DATA BANANA,85,2,0,9,0,23,EACH
2005 DATA BLACKSTRAP MOLASSES,45,18,0,0,0,11, TABLESPOON
2007 DATA BROWN SUGAR,820,66,0,0,0,212,CUP
2010 DATA BUTTER,100,116,12,0,0,0, TABLESPOON
2015 DATA BUTTERMILK,100,257,2,0,8,12,CUP
2020 DATA CANNED BEETS,55,479,0,8,2,12,CUP
2025 DATA CANNED CARROTS,45,386,0,5,1,10,CUP
2027 DATA CANNED CHERRIES,105,10,0,2,2,26,CUP
2030 DATA CANNED CORN,110,384,1,1,6,4,33,CUP
2032 DATA CANNED LIMA BEANS,260,5,1,0,16,49,CUP
2035 DATA CANNED PEACHES,200,15,0,6,1,51,CUP
2040 DATA CANNED PEARS,195,15,1,2,1,50,CUP
2042 DATA CANNED PEAS,150,493,1,1,4,8,29,CUP
2043 DATA CANNED PINEAPPLE,190,7,0,4,1,49,CUP

```

```

2045 DATA CANNED SKIM MILK,200,294,1,0,19,29,CUP
2047 DATA CANNED WHOLE MILK,340,266,19,0,17,25,CUP
2050 DATA CELERY,5,25,0,3,0,2,EACH
2060 DATA CHEDDAR CHEESE,115,176,9,0,7,0,OUNCE
2065 DATA CHICKEN,1326,366,91,0,114,0, POUND
2070 DATA COD,777,483,23,0,128,0, POUND
2073 DATA CREAM,210,671,2,1,6,5,51,CUP
2075 DATA CREAM CHEESE,100,84,10,0,2,1,OUNCE
2080 DATA DRY NONFAT MILK,245,644,0,0,24,35,CUP
2085 DATA EGG,80,59,6,0,6,1,EACH
2090 DATA EGG WHITE,15,50,0,0,3,0,EACH
2095 DATA EGG YOLK,65,9,6,0,3,0,EACH
2100 DATA FRESH ASPARAGUS,12,5,1,0,1,25,.5,EACH
2105 DATA FRESH BLUEBERRIES,85,1,1,2,2,19,CUP
2110 DATA FRESH BROCCOLI,45,23,1,1,9,6,8,EACH
2115 DATA FRESH CARROTS,30,34,0,9,1,7,EACH
2117 DATA FRESH CAULIFLOWER,30,17,0,1,3,26,CUP
2120 DATA FRESH CORN,70,1,1,8,2,16,EACH
2125 DATA FRESH PEACHES,40,1,0,1,1,10,EACH
2130 DATA FRESH PEARS,100,1,1,2,1,25,EACH
2135 DATA FROZEN BROCCOLI,50,35,1,1,9,5,9,CUP
2140 DATA FROZEN CAULIFLOWER,30,18,0,1,3,31,CUP
2145 DATA FROZEN CORN,130,7,1,8,5,31,CUP
2150 DATA FROZEN PEAS,110,264,0,6,8,19,CUP
2155 DATA FLOUNDER,914,1065,37,0,137,0, POUND
2160 DATA GRANULATED SUGAR,770,2,0,0,0,199,CUP
2165 DATA GROUND BEEF,1307,282,91,0,112,0, POUND
2170 DATA HAM,1547,5904,117,0,85,0, POUND
2175 DATA HOT DOG,170,627,15,0,7,1,EACH
2180 DATA LAMB,1675,307,75,0,107,0, POUND
2185 DATA LEMON,20,1,0,0,1,6,EACH
2190 DATA LIGHT MOLASSES,50,3,0,0,0,13, TABLESPOON
2195 DATA MARGARINE,100,140,12,0,0,0, TABLESPOON
2200 DATA ORANGE,65,1,0,0,1,16,EACH
2205 DATA PEANUT BUTTER,95,81,8,9,4,3, TABLESPOON
2210 DATA POWDERED SUGAR,385,1,0,0,0,100,CUP
2215 DATA QUICK RICE,180,13,0,4,4,40,CUP
2220 DATA SOUR CREAM,495,96,48,0,7,10,CUP
2225 DATA SWISS CHEESE,105,74,8,0,8,1,OUNCE
2230 DATA TUNA,907,1606,37,0,133,0, POUND
2235 DATA WHITE RICE,185,6,0,3,4,41,CUP
2240 DATA WHOLE MILK,150,122,8,0,8,11,CUP
3000 N1 = 0:N2 = N1:N3 = N1:N4 = N1:N5 = N1:N6 = N1:F1 = 0:FL = 0:NA = 0

3005 FOR I = 1 TO NI
3010 GOSUB 1400
3015 IF FL = 1 THEN FL = 0:F1 = 1:NA = NA + 1:NA$(NA) = I$(I): GOTO 303
5
3020 IF NU$(I) < > UN$(M) THEN GOSUB 1500
3025 N1 = N1 + AM(I) * C(M):N2 = N2 + AM(I) * S(M):N3 = N3 + AM(I) * F(M)
)
3030 N4 = N4 + AM(I) * FB(M):N5 = N5 + AM(I) * P(M):N6 = N6 + AM(I) * CB
(M)
3035 NEXT I
3040 N1 = INT ((N1 / SV) + .5):N2 = INT ((N2 / SV) + .5):N3 = INT ((N
3 / SV) + .5)
3045 N4 = INT ((N4 / SV) + .5):N5 = INT ((N5 / SV) + .5):N6 = INT ((N
6 / SV) + .5)
3050 RETURN
3099 REM      CENTERING ROUTINE
3100 PRINT TAB( (40 + 1 - LEN (T#)) / 2)T#
3105 RETURN

```

What is Public Domain Software?

Public Domain Software (PDS) consists of programs that are donated to the public, and therefore, have no copyrights attached. They are written by a variety of people, some professionals, some not—in most cases each program is NOT commercial-quality and is not supported as such.

Who can use the Library?

Our library is supplied in DOS 3.3, 16 sector format for Apple II computers. Please note that a few machine language programs will function erratically on the IIe and IIc because of changes in the F8 monitor. We have not tested all of the programs nor do we have a list of what works. So be careful—"Caveat Emptor."

What does the Computer Learning Center do?

The Computer Learning Center provides a service that copies and DISTRIBUTES software in the public domain. Our library is constructed on a "per volume" basis, each volume containing approximately 20 programs. The \$4/volume fee covers the cost of the disk and costs involved in copying, labeling, packaging, mailing and other related expenses. Due to the nature of our library, PDS cannot be returned for a cash refund or exchanged for different volumes.

When using our PDS listings, the volume name and number is in **reverse** print. Use the volume number next to the name when you order. Each volume name is followed by a list of programs on that disk. (Except Eamon, where only the scenario title is listed.) The left column of this list indicates the language required by the program. (A—Applesoft, I—Integer, B—Machine Code, and T—Text Files.)

How to Order:

1. Select the volumes with the programs that you want.
2. Check the numbered boxes on this form that match your selections.
3. For every 10 volumes that you order, you get 1 free bonus volume. Circle your FREE bonus selection on the order form.
4. Fill in the address information. (Please print neatly.)
5. Total the number of volumes that you are ordering and multiply this number by \$4.00. The minimum order is two (2) volumes.

* Washington residents add 7.8% sales tax.

* Overseas, Canada, and Mexico: add 20% for shipping.

6. Send a check or money order for the total amount due. We accept VISA/MC. Credit card orders must have a valid signature. We accept international money orders (in USA funds) and checks drawn on USA banks. Canadian checks must specify USA dollars. Make them payable to: Computer Learning Center P.O. Box 110876-1 Tacoma, WA 98411

<input type="checkbox"/> E01	<input type="checkbox"/> E10	<input type="checkbox"/> E19	<input type="checkbox"/> E28	<input type="checkbox"/> E37	<input type="checkbox"/> E46	<input type="checkbox"/> E55	<input type="checkbox"/> E64	<input type="checkbox"/> E73	<input type="checkbox"/> E82
<input type="checkbox"/> E02	<input type="checkbox"/> E11	<input type="checkbox"/> E20	<input type="checkbox"/> E29	<input type="checkbox"/> E38	<input type="checkbox"/> E47	<input type="checkbox"/> E56	<input type="checkbox"/> E65	<input type="checkbox"/> E74	<input type="checkbox"/> E83
<input type="checkbox"/> E03	<input type="checkbox"/> E12	<input type="checkbox"/> E21	<input type="checkbox"/> E30	<input type="checkbox"/> E39	<input type="checkbox"/> E48	<input type="checkbox"/> E57	<input type="checkbox"/> E66	<input type="checkbox"/> E75	<input type="checkbox"/> E84
<input type="checkbox"/> E04	<input type="checkbox"/> E13	<input type="checkbox"/> E22	<input type="checkbox"/> E31	<input type="checkbox"/> E40	<input type="checkbox"/> E49	<input type="checkbox"/> E58	<input type="checkbox"/> E67	<input type="checkbox"/> E76	
<input type="checkbox"/> E05	<input type="checkbox"/> E14	<input type="checkbox"/> E23	<input type="checkbox"/> E32	<input type="checkbox"/> E41	<input type="checkbox"/> E50	<input type="checkbox"/> E59	<input type="checkbox"/> E68	<input type="checkbox"/> E77	
<input type="checkbox"/> E06	<input type="checkbox"/> E15	<input type="checkbox"/> E24	<input type="checkbox"/> E33	<input type="checkbox"/> E42	<input type="checkbox"/> E51	<input type="checkbox"/> E60	<input type="checkbox"/> E69	<input type="checkbox"/> E78	
<input type="checkbox"/> E07	<input type="checkbox"/> E16	<input type="checkbox"/> E25	<input type="checkbox"/> E34	<input type="checkbox"/> E43	<input type="checkbox"/> E52	<input type="checkbox"/> E61	<input type="checkbox"/> E70	<input type="checkbox"/> E79	
<input type="checkbox"/> E08	<input type="checkbox"/> E17	<input type="checkbox"/> E26	<input type="checkbox"/> E35	<input type="checkbox"/> E44	<input type="checkbox"/> E53	<input type="checkbox"/> E62	<input type="checkbox"/> E71	<input type="checkbox"/> E80	
<input type="checkbox"/> E09	<input type="checkbox"/> E18	<input type="checkbox"/> E27	<input type="checkbox"/> E36	<input type="checkbox"/> E45	<input type="checkbox"/> E54	<input type="checkbox"/> E63	<input type="checkbox"/> E72	<input type="checkbox"/> E81	
<input type="checkbox"/> P01	<input type="checkbox"/> P02	<input type="checkbox"/> P11	<input type="checkbox"/> P18	<input type="checkbox"/> P19	<input type="checkbox"/> P20	<input type="checkbox"/> P21	<input type="checkbox"/> P36	<input type="checkbox"/> P50	<input type="checkbox"/> P59
<input type="checkbox"/> P61	<input type="checkbox"/> P67	<input type="checkbox"/> P71	<input type="checkbox"/> P76						

Send me the volumes that I have checked. I understand that the minimum order is two volumes.

Name _____

Address _____

City _____ State _____ Zip _____

Country _____ Phone _____

  _____ Exp _____

Signature _____

Public Domain Software is supplied as-is.

I 5/86

What is an

Eamon Adventure?

Eamon Adventures are a collection of entertaining, flexible, fantasy role-playing, text-adventures in the public domain.

MASTER/Beginner's Cave.

The Master Diskette is **required** to play EAMON. It is used to create your character and stores the character data between adventures. This volume also contains the Beginner's Cave—a short (but not entirely safe) romp for your new character. (Highly recommended training for new adventurers.)

EAMON Adventures

E1 MASTER/Beginner's Cave	E43 Tomb of Y'Golonac
E2 Lair of the Minotaur	E44 Operation Crab Key
E3 Cave of the Mind	E45 Feast of Carroll
E4 Zephyr River Venture	E46 The Master's Dungeon
E5 Castle of Doom	E47 Crystal Mountain
E6 Death Star	E48 Lost Adventure
E7 Devil's Tomb	E49 The Manxome Foe
E8 Abductor's Quarters	E50 Behind the Sealed Door
E9 Assault of the Clone Master	E51 Land of Death
E10 Magic Kingdom	E52 Jungles of Vietnam
E11 Tomb of Molinar	E53 Black Castle of Nagog
E12 Quest for Trezore	E54 Sewers of Chicago
E13 Caves of Treasure Island	E55 Caverns of Doom
E14 Furioso	E56 Valkenburg Castle
E15 The Heroes' Castle	E57 Modern Problems
E16 Caves of Mondamen	E58 Priests of Xim
E17 Merlin's Castle	E59 Escape from the Orc Lair
E18 Hogarth Castle	E60 Castle of Count Fuey
E19 Death Trap	E61 Search for the Key
E20 The Black Death	E62 The Rescue Mission
E21 Quest for Marron	E63 The Maze of Quasequeton
E22 Senators' Chambers	E64 Chamber of the Dragons
E23 Temple of Ngurct	E65 Swordquest
E24 Black Mountain	E66 Smith's Stronghold
E25 Nuclear Nightmare	E67 Picnic in Paradise
E26 Assault on the Moleman	E68 The Caves of Eamon Bluff
E27 Revenge of the Moleman	E69 Future Quest
E28 Tower of London	E70 Castle Kophinos
E29 Lost Island of Apple	E71 The Devils Dungeon
E30 Underground City	E72 Harpy Cloud
E31 Gauntlet	E73 The School of Death
E32 House of Ill Repute (Adult)	E74 The Dungeons of Xenon
E33 Orb of Polaris	E75 Chaosium Caves
E34 Death's Gateway	E76 Life Quest
E35 Lair of the Mutants	E77 Dharmquest
E36 Citadel of Blood	E78 Mean Streets
E37 Quest for the Holy Grail	E79 The Temple of the Guild
E38 City in the Clouds	E80 Deep Canyon
E39 Museum of Unnatural History	E81 The Castle of Rauneta
E40 Deamons Playground	E82 The Prince's Tavern
E41 Caverns of Lanst	E83 The Search for Yourself
E42 Alternate Beginner's Cave	E84 The Temple of the Trolls

FreeWare: MORE Public Domain Software

P01 Apple Tutor

I 036 Basic Programming 1
I 047 Basic Programming 2
I 048 Basic Programming 3
I 044 Basic Programming 4
A 004 Basic-Integer
B 022 Basic-Integer.X
I 019 Conventions
I 016 CPU 6502
I 002 Hello Sample
I 030 Micro 6502 Simulation
I 051 Mini Assembler Tutorial
A 022 Random Drill Tutor
I 007 Sweet 16 Disassembler
I 004 Sweet 16 Speed ?
I 026 Top Down Programming

P02 Apple Tutor

A 021 Apple II Demo
A 004 Basic Exercise
I 043 Basic-Applesoft
I 093 Disk Aide.13
I 038 Disk Aide DOC
B 003 Disk Aide.X
A 028 DOS System Instruction
A 013 Pilot Version I
I 054 Program Devel. Pkg
A 014 Suppl. Mini Assembler
B 006 Supplement.X
I 003 Text File Read
I 003 Text File Write
I 009 Text Hello
T 009 Text How To
T 010 Text Intro
T 006 Text Peek Poke Call
T 010 Text Programming
T 007 Text Redbook
T 011 Text Software
A 002 Buzz

P11 Art & Graphic

A 006 Art Align
A 002 Art Bars
A 003 Art Circle
A 002 Art Demo
A 003 Art Diverging Circles
A 003 Art Diverging Octagons
A 003 Art Double Cross
A 006 Art Dougs Theme
A 003 Art Drifting Circle
A 003 Art Drifting Octagon
A 004 Art Elephant
A 003 Art Figure 8
A 005 Art Horizon
A 007 Art IBM
A 003 Art Octal 8
A 002 Art Oneliner 7
A 007 Art Super Kallied
A 003 Art Twist II
A 015 Art Xmas Card
A 014 Auto Space War II
A 002 Billboard Mother
A 002 Graphic Switch
A 010 Graphics Tablet
A 008 Hi-res Text Demo ?
B 007 Hi-res Text Set
A 004 Higher Hires
A 006 Hires Sketch
A 003 Invert Monitor Mode
A 035 Life
B 015 Life Language
A 004 Life Leader
A 002 Picture Loader
A 016 Plot Pourri

A 010 Poster ?
A 008 Poster Banner I
A 009 Poster Love II
A 003 Rubber Apple
A 020 Shape Editor
A 010 Shape Generator
A 003 Shape Instr
A 023 Shape Table Editor
T 001 Shape Table for Hires Label
T 002 Shape Test
A 015 Skywriter
A 003 Skywriter I
A 003 Skywriter II
A 025 Skywriter Instr
A 013 Skywriter Snoopy
B 018 Star.shape
A 005 TV Pattern Generator

P18 Business & Finance

A 005 Annuity Principal & Int.
A 003 Annuity Reg. Deposits
A 018 Annuity ◀
A 013 Bond Price & Interest
A 012 Bond Value
A 032 Budget Monthly
A 013 Decision Matrix
A 054 Financial Pak
A 016 Invest. Annuity Forecast
A 012 Keogh Savings Program
A 014 Loan Amort. Schedule
A 008 Loan Direct Reduction
A 004 Loan Interest
A 029 Market Evaluator Pak
A 009 Mortgage Calculation
A 007 Nicer Writer ◀
A 003 Regular Deposits I
A 007 Sales Tax At 6%
A 017 Security Analysis
A 006 Sec. Analysis Copy Data
A 003 Simple Interest
A 010 Stock Option Analysis
A 016 Stock Op covered hedge
A 015 Stock Option Pricing I
A 021 Stock Option Pricing II
A 008 Stock Portfolio Valuation
A 028 Stocks
A 010 Trip Cost Analysis

P19 Business & Finance

I 030 Calendar Personal
I 006 Letter Writer
I 006 Letter Writer Enhance
I 014 Phone List
I 005 Real Estate Plot
B 034 Real Estate Plot.X
A 012 Stock Monitor I
A 015 Stock Monitor II
A 024 Trend Line Analysis
A 006 Viscalc Coord Formulas
A 012 Viscalc D File Printer
A 014 Viscalc Formulas
A 006 Viscalc Formulas Instr

P20 Business & Finance

A 025 Apartment Mortgage
A 052 Banking And Finance
A 058 Business Finance
A 006 Check Stub
A 020 Household Exp. Profile
A 041 Income Tax 1040 For 77
A 029 Inventory Company
A 004 Inventory Cost File Entry
A 016 Inventory Home I

A 022 Inventory Model
A 009 Inventory Print ◀
A 003 Inventory Shortest
A 003 Inventory Shortest Read
A 023 Inventory
A 003 Inventory.DOC
A 019 Inventory.File Create
A 029 Inventory.File Read
A 018 Stock Market Forecaster
A 011 Stock Valuation

P21 Business & Finance

A 004 Annuity
A 004 Average Growth Rate
T 001 Basenamefile
A 046 CAC Record System ◀
A 009 Check Book Balancer
A 008 Check Writer
A 004 Depreciation Amount
A 003 Depreciation Rate
A 010 Depreciation Schedules
A 003 Depreciation Straight
A 004 Disc. Commercial Paper
A 024 House Sales
A 005 Income Taxes
A 012 Interest Earned
A 003 Interest Rate
A 038 Inventory Home II
A 004 Invest. For Withdrawals
A 004 Investment Future Value
A 004 Investment Initial
A 013 Lease Computation
A 031 Life Mgmt And Finances
A 012 Life Mgmt Txt Organizer
A 005 Loan Balance
A 007 Loan Interest Rate
A 005 Loan Last Payment
A 004 Loan Principal
A 005 Loan Regular Payment
A 004 Loan Term
A 004 Mortgage Computer
A 007 Mortgage Table
A 063 Payroll
A 004 Regular Deposits II
A 003 Regular Withdrawals
A 004 Salvage Value
A 009 Savings Growth
A 011 Survey Data Reduction
A 003 System Reliability
A 004 Treasury Bill Valuation

P36 Game

A 027 Blackjack Strategy
A 012 Combat
A 017 Craps BW
A 035 Cribbage I BW
A 028 Football Predictions
A 011 Fox And Hounds
A 026 French Military Game
A 020 Gold Mine
A 022 Golf II
A 016 Hi Q
A 027 Hockey I
A 021 Horse Race III
A 031 Kingdom
A 008 Literature Quiz
A 026 Marooned In Space
A 004 Ping Pong
A 010 Robot BW
A 016 Survive
A 018 Twonky I
A 018 Word Maze Maker
A 003 Football Predictions.note

P50 Game

A 017 Battle
A 015 Century 51
B 002 Century 51.X
A 020 Checkers II
A 021 Commodity Market
A 016 Craps I
A 013 Cryptograms
A 017 Frustration
A 027 Geography II
A 015 Hangman II
A 022 Lunar Landing BW
A 061 Market Crash
B 005 Market Crash.X
A 009 Name the States
A 018 Puzzle Generator
A 007 Solitaire Checker Puzzle
A 010 Spell the States
A 012 Subscan for Two
B 002 Subscan.X
A 031 World War

P59 Math & Statistics

A 008 Anglo To Metric I
A 011 Anglo To Metric II
A 003 Arcsin Arccos
A 016 Calculator
A 007 Calculus I
A 013 Calculus II
A 007 Cash Register
A 005 Circle Area Circum
A 009 Compound Interest
A 010 Critical Path Analysis
A 006 Curve Fit I
A 013 Curve Fit II
A 013 Curve Fit III
A 003 Derivative of Equation
A 010 Differential Eqn Solver
A 015 Equation Solver
A 005 Equations I
A 014 Equations II
A 014 Factor
A 003 Fibonacci Numbers
A 012 Foot Candle Analysis
A 010 Fourier
A 011 Fourier Transform
A 007 Gaussian Quadrature II
A 010 Math Drill I
A 011 Math Drill II
A 005 Matrix Inversion II
A 009 Matrix Operation
A 016 Mean Vari Stdr Devia II
A 007 Mode Finder
A 003 N Factorial
A 007 Plot Consec. Reactions
A 006 Plot Functions of X
A 003 Prog Chart ?
A 011 Robot Motor Design
A 005 Sine Function
A 010 Statistics I
A 014 Statistics II
A 014 T Test Stdn Deviation
A 004 Time Speed Dist. Exer.
A 006 Time Speed Dist. Fuel
A 014 Triangle Solver
A 011 Unpaired Group Comp.

P61 Math & Statistics

A 003 Angle Conversion
A 012 Anglo To Metric III
A 003 Area of Polygon
A 008 Binomial Distribution
A 004 Blackbody
A 003 Chi Square Distribution

A 004 Chi Square Test
A 004 Coordinate Conversion
A 008 Coordinate Plot
A 003 Curvilinear Interpolation
A 002 Derivative
A 016 Dfit
A 011 Differential Eqn Solver
A 004 Exponential Regression
A 004 F Distribution
A 004 Gaussian Quadrature I
A 003 Geometric Mean
A 004 Geometric Regression
A 004 Greatest Comn Denom.
A 005 Histogram
A 003 Linear Interpolation
A 007 Linear Programming
A 004 Linear Regression
A 005 Mann Whitney U Test
A 022 Math Drill III
A 019 Math Multiply Drill
A 019 Math ◀
A 013 Matrices

A 004 Matrix Inversion I
A 004 Matrix Multiplication
A 004 Matrix Operation Simple
A 004 Mean Vari Stdr Devia I
A 007 Mult. Linear Regression
A 004 Normal Distribution
A 006 Nth Order Regression
A 004 Number Combinations
A 002 Parabola Plot
A 003 Permutation Comb. I
A 007 Permutation Comb. II
A 003 Poisson Distribution
A 006 Polar Equation Plot
A 011 Polyfit
A 013 Polynomial Regression
A 006 Power Curve Fit ◌
A 003 Prime Factors I
A 006 Prime Factors II
A 003 Quadratic Formula
A 006 Quadratic Surface
A 015 Right Triangle Solver
A 016 Root Finder
A 005 Roots of Poly Half
A 005 Roots of Polynomials
A 004 Simpson's Rule
A 004 Simultaneous Equations
A 004 T Distribution
A 005 T Distribution Test
A 003 Trapezoidal Rule
A 005 Triangle Factors
A 007 Triangle Parts
A 003 Trig Polynomial
A 004 Vector Analysis
A 003 Vector Operations

P67 Passion (Adult)

A 002 Form 0 Startup
B 034 Form 1
B 034 Form 2
B 034 Form 3
B 034 Form 4
B 034 Form 5
B 034 Form 6
B 034 Form 7
B 034 Form 8
B 034 Form 9
A 005 Hot Apples I
A 006 Hot Apples II
A 013 Touch I
A 013 Touch II
I 013 Zoom 1
I 013 Zoom 2

P71 Pastime & Other

A 048 Bio-Rhythms
A 011 Calendar One Month
A 007 Calendar Perpetual
A 020 Calendar Reminder
I 020 Colossus
A 011 Decision Maker III
I 063 Dirty Tricks Beware
A 025 Dirty Tricks II
B 018 Dirty Tricks.X
I 020 Horoscope
A 026 Miles Per Gallon Record
I 074 Numerology
I 002 Phone Mnemonic 1
B 003 Phone Mnemonic 1.X
A 010 Probability
A 021 Random Insults
I 002 Random Words 1
I 003 Syn Tax
I 008 Timer

P76 Utility

A 003 Base Conversion Chart I
A 003 Base Conversion Chart II
A 006 Base Convert **
A 005 Base Convert Beymer
A 012 Base Convert Ellmers
A 005 Base Convert Jenkins
A 029 Base Convert Massimo
I 043 Basic-Applesoft
A 007 Binary To FP
A 053 Calendar And Posters
A 002 Capture A Program
A 005 Catalog Printer
A 003 Clear Memory
A 004 Copy Text File I
A 004 Copy Text File II
A 004 Copy Text File III
A 004 Ctrl Char Catalog
A 003 Ctrl Char Reveal
A 003 Dump ASCII Memory
A 002 Erase Hires Screen
A 011 Format #
A 003 Free Sectors Aldrich
A 004 Free Sectors Brown
B 002 Free Sectors Brown.X
A 019 Illegal Commands
A 005 List Page Diaz
A 005 List Page Wysocki
B 002 List Page Wysocki.X
B 002 List Page.X
A 007 Mach To Pokes Conv
A 002 Musical Keys
B 002 Musical Keys.X
A 013 Phone Dialer
A 003 Pointers
A 002 PPR# 6 On Reset
A 003 Random Sentence
B 002 Rem Stripper
A 003 Rem Stripper Doc
A 006 Renumber
A 004 Renumber Merge
A 003 Reverse Print
A 018 Sort Catalog
A 015 SSM AIO Board
A 004 String Comparator
A 004 String In A String Search
A 004 Text File Edit
A 003 Text File Peek
A 003 Text File Read & Print I
A 005 Text File Read & Print II
A 005 Text File Write
A 004 Token Address Table I
A 005 Utility Statements

for more information about the vast PDS library, write to CLC PO Box 110876-I Tacoma, WA 98411

Continued from p. 42.

sively hardware-oriented. They follow the CompuServe model—bulletins, club notices, downloads, and conferencing. On-line conferences are actually for all GENie members, not just SIG users. Some include guest "speakers" GENie provides, and some are on topics of general interest. You can also have impromptu conferences whenever you feel inspired.

Shopping, when I accessed it late in 1985, was fairly empty, except for a sort of "yard sale" of items users were offering. Games looked a little harder, boasting a multiplayer, space-conquest adventure and a few other complex pastimes. News and Commentary was fairly bleak, containing information relating more or less only to GENie activities.

What we have in GENie is, as a GE advertising assistant told me on CB, "a baby." GENie is so new—and so skimpy, except for CB—that it's unfair to draw any conclusion about it just yet. Let's hope, though, that instead of merely imitating CompuServe, it develops some unique, compelling features.

Information utilities give you contact

with a wider part of the outside world. CB creates real addicts who are on all night long, night after night. Join the fun, but be prepared to pay the cost.

With charges made automatically against your credit-card account, an information utility can drain you more quickly than you can say "Dracula." Just ask one CBer I met on GENie, who confessed that his monthly CompuServe bill was more than \$1700 (\$6 an hour adds up fast). He had dumped CompuServe and joined GENie because, at \$1 less per hour, he hoped to slow his cash outflow. That's a user gone out of control. Have fun, but don't make the same mistake. ■

Brian J. Murphy
Fairfield, CT

Not the Last Word

BETTERWORKING WORD PROCESSOR WITH SPELLCHECKER

Spinnaker Software, 1 Kendall Square,
Cambridge, MA 02139

Word-processing software and spelling checker; any 64K Apple II
\$59.95

Ease of learning ■■■■
Ease of use ■■■■
Documentation ■
Support ■
Overall ■■

The BetterWorking Word Processor with Spellchecker, the third package in Spinnaker's BetterWorking series, claims to be "ideal" for "all your writing needs." It's better working than its predecessors, File & Report and Spreadsheet (see *inCider's* review in the September 1985 issue, p. 75), and for some users, Word Processor may even be an improvement over programs like Bank Street Writer. Spinnaker's product has some rough edges I can't tolerate.

This package should appeal to owners of unadorned, unenhanced Apple II's. For example, the program offers two display options on one disk—40- and 80-column. Word Processor's features are more or less the

kyan

SOFTWARE for the Apple II Family...

kyan pascal (Version 2.0) for the Apple **\$69.95**

kyan pascal is a ProDOS-based compiler for the Apple II. It's a full Jensen-Wirth/ISO implementation, designed for both beginning and advanced programmers. It's easy to use, lightning fast, and loaded with features like:

- Optimized 6502 machine code compiler/assembler
- Full screen 40/80 column text editor
- String handling and hi-res graphics,
- Support for source code linking, chaining, and random files, and inline or included assembly source code, and
- 13 digit arithmetic precision
- kyan's unique UNIX-like operating environment.
- **kyan pascal** requires only 64K of memory and single disk drive. A CP/M card is not required.

Programming Utility Toolkit **\$49.95**

Makes program development faster and easier. This toolkit includes utilities to generate random numbers, load binary files, sort lists, plus utilities for disk directories, catalogues, and other file management functions.

MouseText Toolkit **\$49.95**

Adds Macintosh-like graphics to your programs! This toolkit includes routines to add windows, pull-down menus, and mouse-controlled cursor movements to your programs.

Advanced Graphics Toolkit **\$49.95**

Adds stunning hi-res and double hi-res graphics programs! The graphics primitives let you develop your own custom graphics. Or, you can use the library routines with windows and clipping, shading, curves, and 2 and 3 dimensional transformations and more.

kyan Macro Assembler and Linker **\$69.95**

kyan's new assembler includes a full-screen text editor, 65C02 assembler, and object module linker. Coupled with kyan's new UNIX-like operating environment, this package offers programmers unsurpassed speed and programming efficiency.

15 DAY TRIAL

We Guarantee Your Satisfaction!

Try any **kyan product** for 15 days. If not completely satisfied, return it for a refund.

Send Check/Money Order: **kyan software**, Dept. Y
Or Call: (415) 626-2080 1850 Union Street, #183
Visa/MC Accepted San Francisco, CA 94123

Please include \$4.50/order for shipping/ handling; \$12 outside North America. CA residents add 6.5% sales tax. Purchase orders accepted. Sorry, no COD's.

same for both versions, but the 40-column display is a joy to work with and closer to WYSIWYG (what you see is what you get) than the 80-column. Underlining and boldface appear on screen as they would on the printed page. You may appreciate the clear readability of the 40-column display, as well.

Menu Selection

BetterWorking Word Processor presents all menu choices in checklist format in a rectangular box. The Main Menu contains major word-processing and computing tasks: Edit, Save, Spellchecker, Print, Help, Housekeeping, New Document, Tabs, Quit WP, and Exit. You move up and down the list of choices by pressing the up- or down-arrow keys, and make a selection by hitting the return key.

This menu-selection procedure is the easiest mouseless method I know. It's quite similar to the horizontal selection process in the Bank Street series. Sometimes when you gain, though, you lose. Experienced—or im-

patient—users may tire of this rather tedious approach. The Spellchecker (on the flip side of the Word Processor disk) and Print programs load very slowly, and may also frustrate experienced users.

Once in memory, Spellchecker works quickly. It "knows" 50,000 words, and you can add terms not normally found in *The American Heritage Dictionary*, on which Spellchecker is based.

If you're a novice, the Please Take Note boxes on screen will help you use the program and avoid mistakes. For instance, the program doesn't let you open a new document (clear memory) without warning you that the "current document will be lost unless you have saved it." You confirm by selecting the Yes or No option from the box.

Extensive Commands

You choose editing and formatting functions by means of control commands. Some of them are mnemonic, but it may take a while to figure them

out. For example, you execute the option to "move to beginning of document" by pressing Control-F, and "move to end of document" with Control-L (first and last?).

Other commands are clearly mnemonic and easy to learn. Control-O is the overwrite/insert toggle. A certain few commands, such as Control-Z to mark a block and Control-P to hide markers, are nonmnemonic.

The commands for accessing the majority of routine functions are the same in both the 40- and 80-column versions of Word Processor, but there are a few differences. Boldface in 40-column mode is activated with a Control-B, Control-b toggle. In 80-column mode, you have to call up "micro-commands," a series of features activated with Control-X. Boldface in 80-column mode requires a Control-X-B, Control-X-b sequence. Other micro-commands tell your printer when to underline, put in subscripts or superscripts, and change to italic, elite, double-width, or condensed mode.

SPELL CHECKER AND MAILMERGE FOR APPLEWORKS

Now... the luxury of a spelling checker and mailmerge for only \$49.95!

Spellworks was written exclusively for Appleworks... it fits Appleworks like a glove. Typing and spelling errors are a thing of the past when you use Spellworks!

...I am impressed by Spellworks, not only because of the errors it detects, but also for the number of errors which it does not detect. By this I mean that it has a powerful vocabulary, and it recognizes a large number of variations of words so that it does not incorrectly call errors. The program is easy to use. I didn't even have to use the manual which came with the program. Good job and keep up the good work

*Manager, Electrical Engineering Kenneth McCuen
Solitec, Inc., Santa Clara, CA*

If you've got Appleworks, you need Spellworks. It's a steal — spelled s-t-e-a-l!

- Utility that merges Appleworks Data Base with Appleworks Word Processor.
- 90,000 Words
- Checks 10 words per second
- Word count 10 per second
- All on one diskette!

Advanced Logic  Systems, Inc.

1195 E. Arques Avenue • Sunnyvale, CA 94086 • 408/730-0307

ONLY \$49.95!

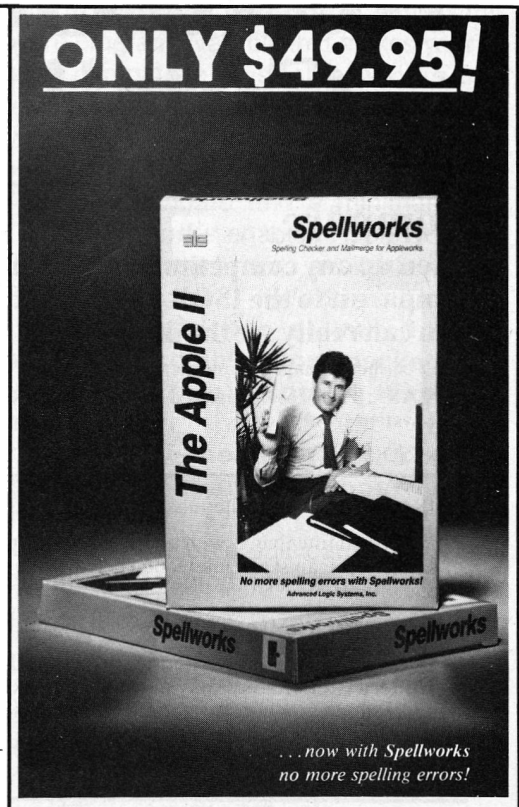

Besides control commands and microcommands, Word Processor uses embedded commands to help you set up your page layout (margins, justification, line spacing, page numbering, headers, and footers). Instead of the dot commands you may know from Apple Writer, you use exclamation-mark commands. Most are mnemonic: !LM5 sets your left margin at column 5, for instance.

So many commands! A large number of commands is the price you pay for the many features Word Processor offers. They're not that difficult to learn, though, and Spinnaker includes a Quikstart card you can keep near your computer, for times when your memory needs a boost.

Printing Problems

If you consider purchasing Word Processor, make sure it can work with your printer. It supports many popular dot-matrix models—the Apple ImageWriter, Scribe, and Dot Matrix, Epson RX and FX, Gemini 10X, Centronics, and Okidata. Word Processor is sup-

posedly compatible with the Brother series of letter-quality printers, as well, but my Brother HR-10 wouldn't operate. I tried the Universal printer option, but that didn't work, either.

I called Spinnaker and explained that the printed page looked like abbreviated nonsense. The customer-service people told me to simply "change the alphabet" by using a Word Processor feature that lets you define keys as foreign-language characters. I fixed the problem myself, by using the Apple ProDOS Utilities to set the serial port on my //c before booting Word Processor.

If you own a basic Apple system and are looking for an easy-to-use word processor, Spinnaker's release may serve your needs. Just don't forget that Word Processor may not be ideal for *all* your needs. ■

*Cynthia E. Field
Wakefield, RI*

Editor's note: Cynthia found the documentation that accompanied Word Processor an "embarrassment," and

Andrea Werboff at Spinnaker agreed: "Some misprinted documentation was shipped, and some early versions. We apologize for the error and ask that customers with problems please call." The new documentation, which we at inCider have checked, is complete.

Copy That Carefully

ECHO PLUS

Agranat Systems, 10 Winthrop Circle, Weston, MA 02193

Copy utility; any Apple II, two drives recommended
\$59.95 (plus \$5 shipping and handling)

Ease of setup	■ ■ ■ ■
Ease of use	■ ■ ■ ■
Documentation	■ ■ ■ ■ ■
Support	■
Overall	■ ■ ■ ■

The time to think about purchasing a copy utility is *before* your copy-pro-

We've Got Guts!!

Compare

Open up any competitor's model and compare it to the ISOBAR® photo . . .

You can really see the difference!

Don't be short changed by inexpensively designed "protection"!

ISOBAR®: The Most Advanced Power Line Filter to Protect Your Computer. . . And the ONLY surge suppressor to protect your system from itself!

Only ISOBAR® gives you:

1. 18 active electronic filtering components.
2. Individual filter banks with multiple filtering components to safeguard against any interaction between the C. P. U. and printer.
3. Superior RFI/EMI noise suppression and rejection.
4. U.L. listed, AC surge suppressor with full recognition by Underwriters Laboratory not just as an extension cord or spike suppressor but also as an electronic noise suppressor.
5. Exclusive "CASCADE DESIGN" to allow you to choose the level of protection you need.

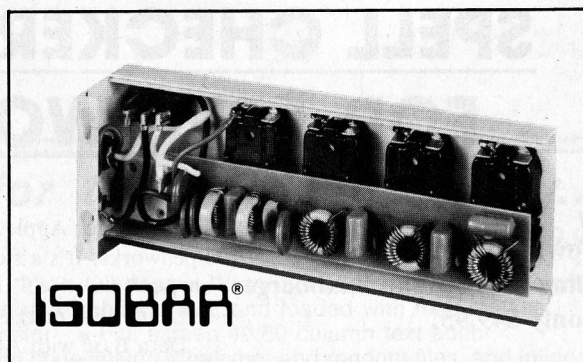

What does full ISOBAR® protection cost?

4 Models with retail prices starting at just \$48.00

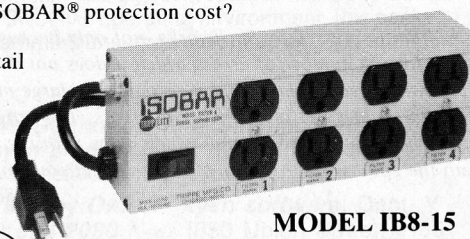

MODEL IB8-15



Call 1-312-329-1777 Est. 1922
500 North Orleans St., Chicago, IL 60610

"THE POWER PEOPLE"

tected disk goes south on you in the middle of a data-base session, just when you can't afford to wait a couple of weeks for a replacement disk. Echo Plus, descendant of the very efficient Echo 1.0, offers many additional features that will make backing up your copy-protected software even easier. The merits of the program may not warrant trading in your present copy program, but first-time buyers should give it serious consideration.

The most unusual feature of Agranat's latest offering is its automatic-copy mode: Echo Plus analyzes the disk being copied and changes its copy parameters to match those it determines will most likely provide a successful copy. Consequently, you can copy many software programs without setting any parameters.

Echo Plus also provides other sophisticated features. A track editor, for example, lets you examine and modify individual bytes on a disk, and the program's nibble counter compares

the number of bits per track on the original and target disks. An examination mode helps you determine the type of copy protection being used, and a disk-drive speed analyzer lets you check or adjust the speed of both the source and target drives.

The documentation supplied with Echo Plus is well written and well suited to its task. In addition to describing the use and purpose of each of the program's features, the manual provides a 12-page section describing how information is stored on a floppy, how a normal disk is formatted, and how several of the more popular copy-protection schemes work. The manual is also nicely organized, separating advanced features from more routine ones.

I had no problems with the program. If you do, though, you can get assistance only "through the mail," as the manual does not provide a number for telephone support. Another odd point about Echo Plus is that the

program is not only copy protected, but is protected so well that you can't use it to make a back-up copy of itself. Agranat does provide a single back-up disk to purchasers for \$15, however. If the program isn't crucial to your operation, you can replace a defective or damaged disk for \$5 upon returning it to the company.

Overall, Echo Plus is a darned good product. The manual explains its various features well, and the program's automatic mode sets it apart from its competitors. ■

*Timothy P. McDonough
Springfield, IL*

Editor's note: Ian Agranat reminds readers that although users cannot call Agranat Systems, the company is eager to provide customer support and will quickly respond by phone to written queries. In addition, Echo Plus is now officially called Agranat Systems Copy Program.

Save Hours! AppleWorks Templates

Accountant Track your personal cash, check & credit card transactions. Allows split transactions, user-defined categories. Reports: checkbook/credit card reconciliation, monthly/year to date/annual budget, taxable income by category, tax deductions by category. Flexible & easy to use.

Accounts Payable Similar to Accountant but for a small business.

Accounts Receivable Records buyer, PO#, order & ship date, item, charges, salesperson, payments, maintains current balance & more. Reports include current accounts receivable, overdue accounts, shipping & mailing labels. Can track inventory and aid marketing analysis. Even prints invoices and bills on standard forms! Easily customized.

Payroll Tracks information for hourly, daily, weekly or monthly employees, including pay rate, regular & overtime hours or days, vacation & sick time, other earnings, gross earnings, state and federal taxes, 1986 FICA, other deductions, net pay, reimbursements. Quarterly, year-to-date & end-of-year totals calculated.

Financial Calculator Calculates simple & compound interest, present value of a future payment or annuity, future value of an annuity (eg. IRA), monthly loan payments, treasury security & bond yields, 10-year loan amortization schedules & others.

Investment Portfolio Summarizes stocks, mutual funds, bonds, CDs. Tracks security by name, price, commission, value, yield, gain/loss, dividend/coupon payments, capital gains status and original and current portfolio value.

REQUIRES: AppleWorks, Apple //c or //e with 128K RAM, 1 disk drive, 80 column monitor. Second disk drive, 132 column printer and keypad optional.

\$29⁹⁵ each

Applied Scientific

416 Arnold, Bozeman, Mt. 59715 (406) 586-1157

TO ORDER: Send check or MO payable to Applied Scientific. VISA/MC: Send number and expiration date and add 5%. Phone orders with bankcards welcomed. Sorry no COD. Complete satisfaction or return disk for refund.

Apple, Apple //c, Apple //e and AppleWorks are trademarks of Apple Computer, Inc. Templates (c) 1986 by R.J. Flaherty.

APPLE® //+ OWNERS...NOW YOU CAN RUN APPLEWORKS!

For all the thousands of Apple //+ owners who've been unable to run AppleWorks, Davka comes to the rescue with **ItWorks™**. **ItWorks** is simply the best software program available that makes your //+ AppleWorks compatible. Just slip **ItWorks** into the disk drive, and your trusty //+ will be able to smoothly run Apple's top-rated integrated software program. **ItWorks** will run with any //+ outfitted with an 80-column board and a minimum 64k memory. In fact, **ItWorks** enables AppleWorks to work with most memory boards available for the //+,—128k,256k, and more! **ItWorks** is available for only **\$39.50**. And, for a limited time, we're selling a combination package of **ItWorks** and **AppleWorks** (newest version—1.3) for just **\$229!** Here's another special value—a genuine Apple 256k memory expansion board and **Itworks** for just **\$239!** To order, call 1-800-621-8227. Major credit cards accepted. All prices plus \$2 shipping. Dealer inquiries welcome.

Davka Corporation
845 N. Michigan Ave.
Chicago, IL 60611

ITWORKS WORKS WITH FRANKLINS, TOO!
Apple is a registered trademark of Apple Computer, Inc.

Circle 144 on Reader Service Card.

CLASSIFIEDS

Digitizers



COMPUTER EYES

- Make custom T-Shirts
 - Print computer portraits
 - Join "free" public domain ART GALLERIES
 - Capture real world images
 - Digitize video signals from: Video Tape Recorders (VCR's), Video Cameras, etc.
 - Hundreds of practical applications
- YES, I want my computer to "see"
YES, Send me ComputerEyes as follows:

Apple ComputerEyes 109.00
Software interface to:

- Print Shop 12.00
Double HiRES (Ile), (Ilc) 12.00
Newsroom 12.00
Panasonic/Ikegami Commercial grade B/W video cameras ... 159.00
Special Hookup cabling with instructions 19.00
UNDERWARE ribbons to make custom heat iron-on transfers for T-shirts, scarves, etc 12.00
Color Pens 12.00
For VISA/MASTER CHARGE ORDERS, Call Toll FREE: 1-(800) 523-2445, x48 (PA Residents call 800-346-7511, x48) or Send Check/Money Order and all inquiries to:

HAL SYSTEMS

P.O. Box 293
Scotch Plains, NJ 07076

Please Note:
Prices include shipping & handling, (continental USA).
One year parts & labor warranty.
For COD orders, add \$5.00
NJ residents add 6%
AVAILABLE for APPLE, ATARI, C-64, AND IBM.
****Dealer Inquiries Invited****

Publications

MICROCOMPUTER BOOKS

Selected Apple II titles include:

- *Apples for Teachers \$12.95
- *Apple Logo for Kids \$8.95
- *Apple II Basic Programs in Minutes \$11.95
- *Basic Apple Basic \$15.95
- *Data Base Management \$13.95
- *Inside the Apple IIc \$17.95
- *Inside the Apple IIe \$17.95
- *Mastering Appleworks \$13.95
- *Multiplan Models \$14.95
- *Visicalc Models for Business \$15.95
- *1001 Things to Do With Your Apple \$8.95

Shipping/Handling extra. MC/VISA/AE. Send for FREE Directory.

MICRO BOOKS

P.O. Box 4068
W. Richland, WA 99352
(800) 547-9755 Ext. 8
(509) 967-5084

Software

DESIGN YOUR OWN LABELS

For disks, name badges, video cassettes, photos, personal property, slides, parts, home canning, advertising, and more. Set height, width & lines-per-inch, then use our unique on-screen edit system to design a label. Edit lines and set formats until it's just right, then print 1 or 1000 copies. Add special "fill-in" fields and PRO LABEL will prompt for new data each time the label's printed. Do serial numbers. Use our prestored designs or make new ones. Requires 128K IIe/IIc & 1 drive. Program, user guide, and 100 free labels: \$19.95 + \$1 shpg. CHK/MC/VISA

PRO LABEL/AP

16 E. Main/P.O. Box 631
Marshalltown, IA 50158
1-800-634-5463

SPEED-UP HOME ACCOUNTANT

Speed up file processing 4-60 times, search 100 times faster, load report program in 40 vs 240 seconds, go directly from program to program, prompts you when splitting transactions, change check-books with a single keystroke, PLUS MORE. The 64K version supports hard disks, ramdisks, 120 categories, prints reports on 80 column card, etc. VISA/MC Accepted. Satisfaction Guaranteed. DOS 3.3 Only. \$19(48K)/\$24(64K) Plus \$2.50 Shipping/Handling

SOFTWARE SOLUTIONS

5516 Merritt Circle
Edina, MN 55436
For Orders Only 1-800-835-2246
Ext. 131

OUTLINER DEL CONDE

Develop outlines, \$39.95: intro price, quantity discounts. Enter ideas as they pop into your mind, then organize them quickly. Ideas can be gathered, split, moved, copied, erased, inserted, appended, and raised/lowered in importance; text processing too. For II+, e, c, U/L case on e/c. 48K, 1 drive. Orders & inquiries to:

DEL CONDE VENTURES

41 Forrest Road
Randolph, NJ 07869

Spreadsheet

APPLEWORKS SUPER GRAB BAG

Why pay more but get less? Send for SUPER GRAB BAG of professional-quality AppleWorks or SuperCalc3a spreadsheet templates and forms: Taxes, Buying a House or Income Property, College Fund, Shopping/Camping lists, Expert System, more. Easy to customize. Save hours of typing, learn new techniques. Send only \$12 ppd plus \$2 S/H. WI add 5%.

PETE PETIT'S SUPER GRAB BAG

1344 N. 31st St.
Milwaukee, WI 53208
(414) 933-4627

Hardware

NEW APPLE PERIPHERALS

Ile 64K/80 Column Bd. \$39. Joystick II/IIe/IIc specify \$14.95. Mouse or Easy Pad Graphic Tablet w/software \$49.95. Cooling Fan II/IIe \$24.95. Add shipping \$3. COD \$2. Phone or Write for complete ill. price list.

NEXO DISTRIBUTION

8824 Golf Drive
Spring Valley, CA 92077
(619) 589-7928

Games

THE GODS HATE MAGICSOFT

They said it couldn't be done. We did it. Now, YOU can experience it. EXODUS CONSTRUCTION SET—The ONLY Ultima III SCENARIO editor \$28.50, (includes LAVALITE WORLD—A harsh new U3 scenario), WIZARDS WORKBENCH—The ONLY Wizardry I-III SCENARIO editor \$34.99, WIZI-SCOUT—inside scoop on all monsters/items \$20, ATOMIC WASTELAND—A NEW Wizi-scenario set in the future \$20. Call 800-628-2828 ext. 5202 Now to order (VISA/MC) or send CHECK, MO. FAST delivery. Money back Guarantee.

MAGICSOFT

P.O. Box 908-I
Danville, CA 94526-0908
(415) 820-0711

Supplies

DISK SALE

SS/DD 35-trk for the Apple w/sleeve & label-10/\$5.80, bulk-100/\$45. Standard SS/DD w/sleeve & label-10/\$7.50, bulk-100/\$59. DS/DD w/sleeve & label-10/\$8.50, bulk-100/\$67. PREMIUM QUALITY, LIFETIME WARRANTY! Money back satisfaction guarantee. Min order \$20. Send check or pay by MC/VISA/AE. \$3, shipping, + \$2 if COD.

UNITECH

201 Hurlley St.
Cambridge, MA 02141
(800) 343-0472
In Mass. (617) 864-8324

STATTUS REPORT

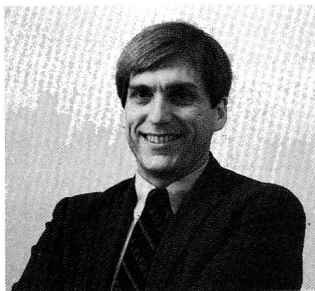

Help Wanted

by Paul Statt, *inCider* staff

I need help. My friends laughed when I told them I had been promoted to technical editor at *inCider*. "You majored in German, not Pascal," they smirked. "You're a better first baseman than programmer. You're going to need help."

Guilty as charged—I can't touch-type in assembler any better than I can in English. So I need—and get—a little help from my friends. And at the risk of making my job obsolete and shrinking my paycheck, I'm willing to pass a little help along to you.

This wisdom was first passed to me by Bob Ryan, sometime *inCider* tech editor and now with *AmigaWorld*. Esoteric cults prefer the guild system to college, anyway—an apprenticeship at the motherboard of a master.

"When someone asks a question you can't answer," Bob mumbled, "look it up in Sather's book."

Jim Sather's book—and mission in life—is ***Understanding the Apple //e*** (Quality Software, 21601 Marilla Street, Chatsworth, CA 91311, 818-709-1721, \$22.95). As Steve Wozniak says in the introduction, "Anyone who is at all concerned about the workings of the Apple //e will benefit from this book, as will students and programmers who have a need for reliable material."

I might have said it better, but whom would you believe, a German major or Steve Wozniak?

Sather takes care of memory management and the //e input/output routines in succinct style—reason enough to own *Understanding the Apple //e*, because those two topics are critical to understanding memory expansion and new storage media. Jim tells you what you need to know about //e hardware.

To solve software problems, you need common sense and patience. If all else fails, read the documentation—or get ahold of a dependable reference.

For instance, for AppleWorks troubles, I first consult the same source I look to for help with ProDOS and DOS 3.3. My source is reliable and witty. And ***Open-Apple*** comes every month.

Open-Apple (P.O. Box 7651, Overland Park, KS 66207, \$24 per year) is a tidy

newsletter, written, edited, and obviously loved by Tom Weishar, former author of the "DosTalk" column in *Softalk*. *Open-Apple* is indispensable. Weishar explains what you need to know and doesn't bore you with what you don't. For instance, his description (April 1985) of the enhanced //e, and how it is and isn't compatible with earlier Apples, gives me all the information I need on that topic. The greatness of *Open-Apple* is that Weishar explains, at the same time, how machine-language programmers get text on the screen.

Weishar is a damned good writer. That's half the pleasure of his trim monthly mis-sive. The other half is the part devoted to readers' problems. Don't settle for a mere subscription: Spring for a complete set of back issues (a little more than a year's worth now) for \$28, because chances are that Tom has already solved your problem.

I'm no machine-language programmer. But you don't have to compose symphonies to enjoy listening to Beethoven, even in a "technical" way—that is, to appreciate that genius' "technique." PEEKs and POKEs are an easy way into the 6502 for outsiders like me. That's why every Apple owner should get a Beagle Bros **Peeks, Pokes and Pointers** chart (Beagle Bros, 4315 Sierra Vista, San Diego, CA 92103, 619-296-7636, free with purchase).

Another good source, and an indicator of Apple Computer's corporate sanity, is **Addison-Wesley Publishing**. All Apple **Technical Reference** manuals, which Apple used to attempt to sell through dealers, are now available from Addison-Wesley. The books are cheaper now and easier to get—at bookstores or directly from Addison-Wesley, One Jacob Way, Reading, MA 01867, (800) 238-3801.

You can pick up the *Applesoft Tutorial* (with disk), \$29.95; the *Applesoft Reference Manual*, \$22.95; *Basic Programming with ProDOS* (with disk), \$29.95; *ProDOS Technical Reference Manual*, \$29.95; and the *Apple //e and //c Technical Reference Manuals*, \$24.95 each. You'll need all these if you want to be a tech editor—and not be embarrassed by your pals' giggling.

From you, dear reader, I ask only for letters, questions, and problems. And stop giggling. ■

"I'm no machine-language programmer. But you don't have to compose symphonies to enjoy listening to Beethoven."

APPLE HARD DISKS
 APPLE II+, APPLE IIe, APPLE III
Systems Starting at \$595.00

ProDOS MOUSE DESK - INSTALLED FREE!
 Very Fast Read/Write, Auto Boots, Compatible
 with Extended Memory and Speed Up Cards.

"QUICK" EXTERNAL 5 1/4" - ProDOS/SOS/NovoComp*

	Now Only	Reg. Price
10mb Complete System @	\$ 595.00	\$ 995.00
16mb Complete System @	\$ 695.00	\$1095.00
20mb Complete System @	\$ 795.00	\$1159.00
40mb Twin 20 Drives @	\$1295.00	\$1795.00

"QUICK" COMPACT 3 1/2" - ProDOS/SOS/NovoComp*

	Now Only	Reg. Price
10mb Complete System @	\$ 795.00	\$1159.00
20mb Complete System @	\$ 995.00	\$1395.00

***NovoComp Apple II Hard Disk Utility Software**

Variable size partitions, any one or all systems:

DOS 3.3, Pascal 1.2, ProDOS 1.1.1, CP/M @ \$150

90 Day Warranty Included - Add'l Year @ \$ 50

Delivery via UPS insured Ground @ \$ 15

Money Back if performance not satisfactory

CMC Computer Systems Phone: 714/835-2462
1514 East Edinger #H Santa Ana, CA 92705

Circle 257 on Reader Service Card.

**WE TURN APPLES INTO GOLD WITH A
 LITTLE ALCHEMY AND LOTS OF ENGINEERING**

SINCE 1981

RGB CARDS

APPLE //E AND //+ **COLORMASTER \$99.**
 & FRANKLIN 2000: **KALEIDOSCOPE // \$139.**

FRANKLIN 1000, 1200: **COLORMASTER \$119.**
KALEIDOSCOPE // \$149.

Cards plug into slot 7. Can be interfaced with //+
 80 column card, or //e 80 column/RAM card.

Compatible with all RGB monitors.
 Cable and connector supplied, + much more.

APPLE //C RGB: \$119.

SONY CPD 1310 super hi-res 13" RGB monitor: \$385.

TELEMAX, INC.

P.O. BOX 339
 WARRINGTON, PA 18976 (215) 343-3000

TOLL FREE: 950-1088, wait for tone,
 then dial **TELEMAX** (touch tone)

**RGB VIDEO DISPLAY INTERFACE
 PRODUCTS FOR IBM-PC & APPLE**

Circle 252 on Reader Service Card.

**P-tral:
 BASIC to Pascal
 Translation Software**

P-tral is the user-friendly translation
 software that converts Applesoft BASIC
 programs to Apple Pascal.

- Translates any business, scientific,
 graphics and game software from source.
- Translation results approach 100%.
- Translates any sized program—
 Large or Small.
- Essential compile directives generated.
- Version 1.0 \$179.00.

REQUIREMENTS: 64/128K RAM, Dos 3.3
 80-column card/Apple II, IIe, IIc
 Apple Pascal 1.1 or 1.2

To order or request more information
 contact **WOODCHUCK INDUSTRIES**
 340 West 17th Street, New York, NY 10011
 (212) 924-0576 / (212) 206-6490

Circle 174 on Reader Service Card.

INDEX TO ADVERTISERS

Reader Service	Page	Reader Service	Page
61	Advanced Logic Systems	University Microfilm . . .	119
		Foreign Dealers	119
23	Advanced Logic Systems	114	Instant Software
		253	Interlude
*	Alf Products	157	Int'l Apple Core
*	Applied Engineering	91	Kyan Software
	2, 3,	28	Legend Industries
	31, 53, 61, 63,	251	MGR Software
	65, 67, CIII	241	Manzanita Software Systems
255	Applied Scientific		39
243	Applied Technology Labs	248	Meacom
	28	208	Micro City
222	AST Research	130	Microsparc
229	Beagle Bros	110	Northeastern Software
179	Beagle Bros	192	Norwich Data Services
*	Business Computers of Peterborough	120	Orange Micro
	18, 19	247	PM Software
*	CH Products	133	Pinpoint Publishing
257	CMC Computer Systems	249	Princeton Graphic Systems
	104	49	Professor Jones
233	Cauzin Systems	128	Programs Plus
	54, 55,	16	Quinsept
	56, 57, 58, 59	41	Quorum Int'l Unltd.
60	Central Point Software	214	Rocky Mountain Medical
*	Cheatsheet Products	250	114
227	Checkmate Technology	84	Sensible Software
	20	85	Sensible Software
103	Classified Ads	242	Sensible Software
78	Clayton & Associates	143	Silicon Express
124	Coit Valley Computers	*	Southern California Research Group
	25	239	27
124	CompuServe Information Services	156	Styleware, Inc
	41	252	Sublogic
76	Computer Learning Center	252	Telemac Corp.
	96, 97	190	Telstar (Zoom Modems)
163	Core Concepts	258	TRIPP LITE
*	Covox	15	Uptime
144	Davka	264	Utilico Microware
184	Digital Visions	135	81
108	Diversified Software		Vilberg Bros Computing
201	Epyx Computer Software	72	114
	107		Wiley Professional Software
245	Firebird	174	52
146	Golem Computers	270	104
254	H&M Disk Drive Systems		Writing Software Int'l Ltd.
	83		35
	inCider Magazine Subscriptions		
	64		
	hotCider		
	80		
	hotCider Back Issues		
	118		
	Moving		
	119		
	Jesse Jones		
	88		
	Mailing List		
	116		

For further information from our advertisers, please use the Reader Service card.

Advertising Sales: East Coast Office (603) 924-7138
 West Coast Office (415) 328-3470

*This advertiser prefers to be contacted directly.

GAME ROOM

by Brian J. Murphy

In *Game Room*, Brian Murphy tells us what's new in the world of Apple games. Look here for inCider's scoop on the latest fun.

inCider's Ratings

- ★★★★ Excellent
- ★★★ Above average
- ★★ Good enough
- ★ Not up to standards
- ☆ The empty set

It's nice to report that George Lucas' foray into home-computer games is still, for the most part, successful. A few months ago I took a long look at *Rescue on Fractalus* (see the January 1986 *Game Room*, p. 114) and liked what I saw. Since then, I've acquired three more Lucasfilm games. All have a science-fiction or fantasy theme. One is excellent, one is quite good, and one is just so-so. Let's begin with the best of the bunch.

Ballblazer

★★★★

Epyx Computer Software
1043 Kiel Court
Sunnyvale, CA 94089
Any 64K Apple II,
joystick optional
\$29-\$39 (dealer-determined)

Ballblazer is a welcome treat. It's an original game with fast action and high tension. It demands a cool head, hair-trigger reflexes, and an alert mind.

You pilot a ground-skimming *rotofoil*—a real triumph of 31st-century technology that uses force fields to capture and shoot the "ball," a glob of energy called a

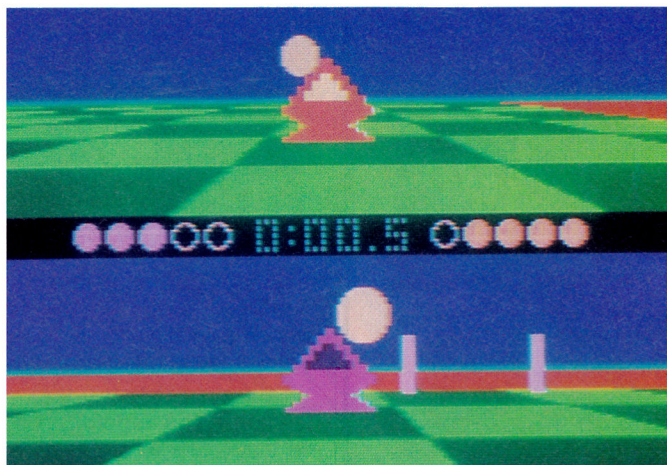

Photo 1: Aim for the goalbeams in *Ballblazer*.

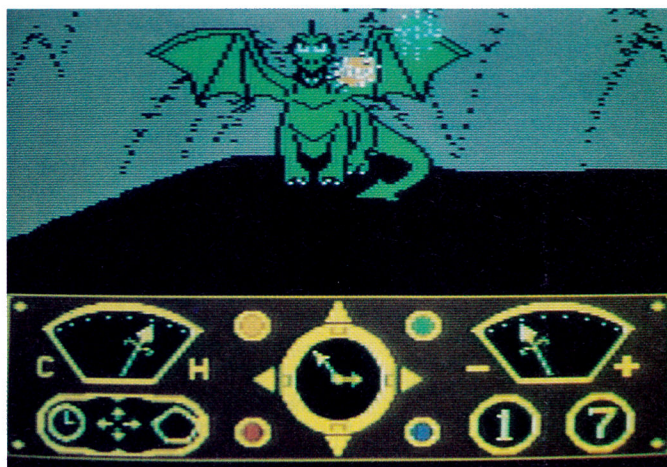

Photo 2: A dragon awaits you in *The Eidolon*.



Photo 3: Flying saucers harass you in *Koronis Rift*.

plasmorb. The car zips over a checkerboard playing field that's 275 meters long by 105 meters wide.

The field is so large that the moving goal at either end is sometimes lost over the horizon. It's a good thing this game isn't real, because the g-forces an actual player would pull to travel these distances would be brutal. As it is, the lightning-quick action on screen is dizzying and disorienting enough.

All you have to do is shoot the plasmorb between the goalbeams to score a point. At a certain distance from the goal, your shot is worth two points. Each time you score a goal, the space between the goalbeams shortens, making subsequent scores more difficult. Also making the play a bit more challenging is a second player (human- or computer-controlled), who's desperately trying to steal the plasmorb and score a goal at the other end of the field. Soccer players will feel right at home.

A split-screen color graphic shows the view from your rotofoil and from the other participant's. Good players will keep an eye on both, to recognize opportunities to steal the plasmorb and to watch for attempted thefts by the opposition. It's disorienting at first, but you'll take pleasure in the technique as your abilities develop. As you improve, you can take on "droid" opponents of increasing skill and determination. At the highest levels of competition, the challenge to just stay in the game, much less win, is almost overwhelming.

Ballblazer offers pure play and pure fun. The graphics are great and the animation outstanding. The

**It Talks!
It Recognizes!
It Writes Music!**
and more . . .

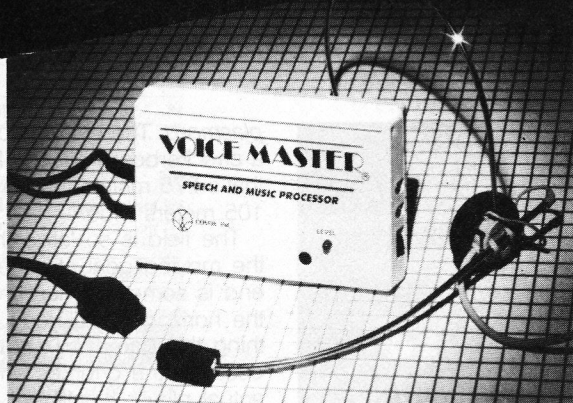

THE AMAZING VOICE MASTER®
Speech and Music Processor

Your computer can talk in your own voice. Not a synthesizer but a true digitizer that records your natural voice quality—and in any language or accent. Words and phrases can be expanded without limit from disk.

And it will understand what you say. A real word recognizer for groups of 32 words or phrases with unlimited expansion from disk memory. **Now you can have a two way conversation with your computer!**

Easy for the beginning programmer with new BASIC commands. Machine language programs and memory locations for the more experienced software author.

Exciting Music Bonus lets you hum or whistle to write and perform. Notes literally scroll by **as you hum!** Your composition can be edited, saved, and printed out. You don't have to know one note from another in order to write and compose!

Based upon new technologies invented by COVOX. One low price buys you the complete system—even a voice controlled black-jack game! In addition, you will receive a subscription to COVOX NEWS, a periodic newsletter about speech technology, applications, new products, up-dates, and user contributions. **You will never find a better value for your computer.**



ONLY \$89.95 includes all hardware and software.

Available from your dealer or by mail. When ordering by mail add \$4.00 shipping and handling (\$10.00 foreign, \$6.00 Canada).

The Voice Master is available for the Commodore 64, 128, Apple IIc, IIe, II+, and Atari 800, 800XL, 130XE. Specify model when ordering. (Apple II+ owners must have joystick adapter. Available from Covox at only \$9.95.)

Apple IIe and II+ owners: Enhance speech quality and music capabilities with optional Sound Master hardware card. Installs in slot 4 or 5. Available separately for \$39.95 with demo software, or order with Voice Master for only \$119.95 (saves \$10 when ordered separately).

For telephone demo, additional information, or prompt service for credit card orders,

 **CALL (503) 342-1271** 

Call or write today for FREE audio demo cassette tape and brochure.



COVOX INC. (503) 342-1271
675-D Conger Street, Eugene, OR 97402
Telex 706017 (AV ALARM UD)

Game Room

sensation of flying along a playing field miles long is compelling. Ballblazer is so realistic you can easily immerse yourself in it for hours and hours. It's the first arcade game I've been able to recommend wholeheartedly in a long time—this is real arcade addition you shouldn't pass up.

The Eidolon

★ ★
Epyx Computer Software
Any 64K Apple II,
joystick required
\$29-\$39 (dealer-determined)

Fantasy is definitely the theme of **The Eidolon**, a title that refers to a sort of interdimensional, mind- and magic-powered traveling machine built by a certain Dr. Josef Vincent Agon back in the 1850's. Behind the controls you travel into a realm of caverns filled with bizarre creatures, roaming fireballs, and trolls. As you complete the exploration of one level, you're admitted to the next (once you've discovered the secret of the guardian dragon). After finishing seven levels or so, the secret of the entire game awaits you.

I know it all sounds very old-hat. That's because it is—the plot isn't significantly different from that of any of dozens of adventures and role-playing fantasies we've all seen before. The level of challenge is good, but you play the game wondering if this trip is really necessary.

The Eidolon is enjoyable in some respects. I like the point of view in the graphics—through the windscreen of the Eidolon as it travels the cave, rather than a representation of a machine traveling a maze, a la Temple of Apshai. It's also fun trying to figure out the best way to cope with the various creatures you encounter. But, as I asked before, is this trip necessary? Not really.

Koronis Rift

★ ★ ★
Epyx Computer Software
Any 64K Apple II,
joystick required
\$29-\$39 (dealer-determined)

Koronis Rift is a variation on the game system of Rescue on Fractalus. In the earlier game you skimmed a toxic planetscape in search of downed pilots, while hostile flying saucers harass you. In this adventure you skim a radioactive planetscape in search of ancient technological artifacts, while—you guessed it—hostile flying saucers harass you. Sound familiar?

In all fairness, the two games aren't completely identical, and the differences make Koronis Rift well worth your attention. Your ship comes with a robot to evaluate the modules you collect. He'll help you decide whether to keep them as a commodity to pile up points, or to integrate them into your ship's systems to improve its performance on the prow and in combat. These devices may include weapons, sensors, propulsion units, energy generators, or shields. Some of the modules drain power from your ship's systems and bring you to a halt. Others work only under certain conditions. Be careful choosing the alien devices you want to use.

Twenty rifts full of these hidden marvels await your search. This will prepare you for the final showdown with the enemy saucer base.

Aside from its similarity to Fractalus, Koronis is an outstanding science-fiction adventure. It's thoroughly engrossing—an excellent introduction to the genre. ■

Brian Murphy is anxious to learn what you think of the current state of computer games. Write him at inCider, 80 Pine Street, Peterborough, NH 03458, and let him know your opinion.

22 FAST-PACED, EXCITING EVENTS. GO FOR THE GOLD!

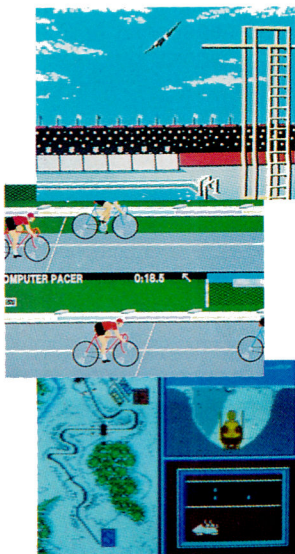

SUMMER GAMES.®

Want some great play action? This award winning best seller brings you eight great events, including Swimming, Diving, Track, Gymnastics, and more. Compete against world records. Or get together with a group of up to eight for some good competitive *fun*. Realistic, graphics and *action* will challenge you again and again to *go for the gold*.

SUMMER GAMES II.™

You asked us for more great events. Here they are. Rowing, Triple Jump, Javelin, High Jump, Fencing, Cycling, Kayaking, even Equestrian. Like SUMMER GAMES, you get spine tingling *action and challenge* for one to eight players. These aren't just games. They're *the games*. And you're the star.

WINTER GAMES.™

You've got to see the graphics, and *feel* the knot in your stomach as your bobsled careens along the walls of the run

to know why people are wild over WINTER GAMES. Seven events give you a variety of action—from the endurance of the Biathlon to the timing of the Ski Jump, and more.

What are you waiting for?

Play your favorite events over and over. Play all 22. Set up teams. Challenge your friends. These great action-strategy games are sure to be the stars of *your* collection.

At your local Epyx dealer.

	APPLE	MAC	ATARI	C64/128
Summer Games	✓		✓	✓
Summer Games II	✓			✓
Winter Games	✓	✓		✓



EPYX
COMPUTER SOFTWARE

1043 Kiel Ct., Sunnyvale, CA 94089

Strategy Games for the Action-Game Player®

NEW PRODUCTS

edited by Paul Statt

Hardware

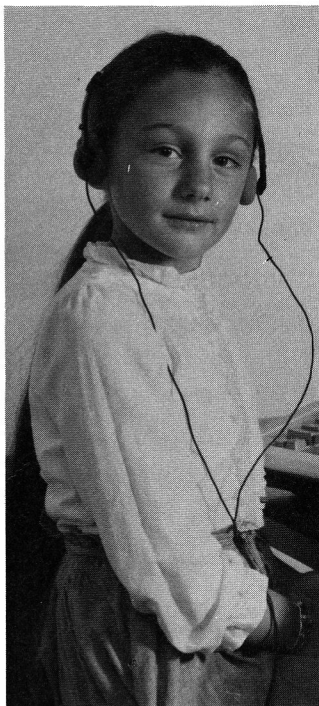

The LittleJack headphone lets kids study—and gives parents peace and quiet.

Quiet Please

LittleJack, a **telephone headset** for the Apple II, II Plus, and IIe, lets children, gamers, and musicians work or play at the keyboard without disturbing teachers, parents, or co-workers. LittleJack installs in minutes, and at \$24.95, also makes an inexpensive stereo hookup. An adapter that allows eight listeners at once is no extra charge, from Educational Software Review, 1400 Shattuck Avenue, #774, Berkeley, CA 94709, (415) 528-2788. For more information circle number 351 on the Reader Service card.

More Equal

The EquiDisk+ subsystem for the Apple II Plus and IIe **increases data storage to 737 kilobytes on a 5¼-inch disk**. You get the storage capacity of a hard disk and the convenience of floppies. EquiDisk+ drives hold five times the data of standard Apple drives and work at twice the speed. And Apple CP/M users are no longer limited to Apple-disk-format CP/M software—the EquiDisk+ can access CP/M with an alternate format. The controller card, high-capacity drives, and startup, format, and copy software sell for \$679, from H&M Disk Drive Services, 1101 East Pacifico, Anaheim, CA 92805, (714) 385-1146. For more information circle number 350 on the Reader Service card.

Nice Network

GCM GridNet, a new **local-area network**, uses a building's existing AC-power wiring in place of cumbersome cables to bring error-free data transmission and reception to users who need more than one Apple. GridNet offers all the advantages of electronic mail, peripheral sharing, and software savings without the headaches of electrical interference. Connect the network with your Apple's RS-232C or parallel interface to the GridComm GC-1400 (\$549) or GC-1100 (\$449), and plug into any AC outlet: instant network. From GridComm, 20 Old Ridgebury Road, Danbury, CT 06810, (203) 790-9077. For more information circle number 370 on the Reader Service card.

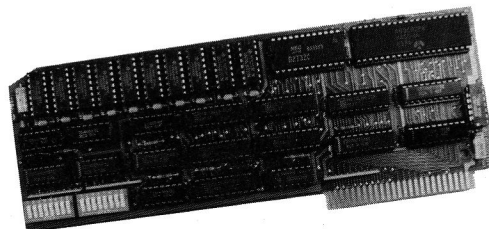

AE's Transwarp accelerates Apple software.

Shades of Gray

The ImageWorks card gives the Apple II series a **full gray-scale display** for graphics-image processing. The ImageWorks image store is 256 lines by 256 columns, with 256 levels of gray for pictures of near-photographic quality. The ImageWorks card contains its own 64K of random-access memory so that the image doesn't squander any of your Apple's RAM. ImageWorks can help display any digitized-image information, and a color option adds up to 256 colors, as well as a video-image-capture option. ImageWorks sells for \$195, the capture and color cards \$95 each, from Redshift Limited, 2727 Midtown Court #7, Palo Alto, CA 94303, (415) 322-7536. For more information circle number 352 on the Reader Service card.

Timewarp Again

Applied Engineering's Transwarp **accelerator card** makes Apple software run 3½ times faster. The accelerator works with all Apple II Plus and IIe software, including AppleWorks, SuperCalc3a, and VisiCalc, as well as with all standard peripheral cards. Transwarp accelerates both banks of memory in a 128K Apple, and complements the huge RamWorks AppleWorks files AE makes possible with faster, more convenient access. Transwarp needs no additional software and fits any slot; you can easily disable its operation with the escape key. Transwarp is priced at \$279, from Applied Engineering, P.O. Box 798, Carrollton, TX 75006, (214) 241-6060. For more information circle number 359 on the Reader Service card.

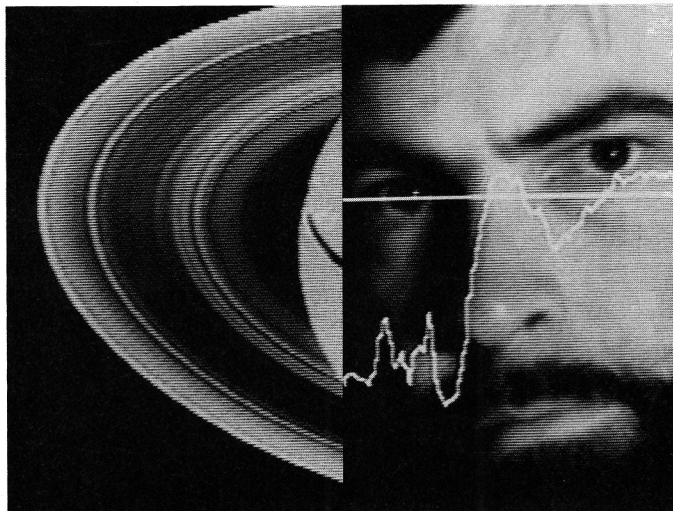

ImageWorks lets you paint in 256 colors or shades of gray.

Software

Food for Thought

ThinkWorks brings AppleWorks aficionados **AppleWorks-compatible outlining power**. ThinkWorks works by itself or with Apple's integrated package. You construct outlines in the standard form—with indenting, labeling, and paragraphing—and integrate them into an AppleWorks word-processor file. You can even merge outlines with ThinkWorks, or pull parts from one outline into another. Outline power for \$125, from MegaHaus, 5703 Oberlin Drive, San Diego, CA 92121, (619) 450-1230. For more information circle number 362 on the Reader Service card.

Sign of the Times

The Micro-Interpreter II is a **computerized animated vocabulary of American Sign Language**. More than 2100 words can be converted into animated American Sign Language—the signs were developed from 5000 photographs of speakers of ASL. No knowledge of ASL or programming is needed. Simple key commands let you stop motion, repeat signs, slow the speed, and so on. Words are grouped into families such as Health and Recreation, Religion, and Verbs. You can order individual disks or the complete package of 16 at prices of \$29.95 to \$49.95 each, from Microtech Consulting, P.O. Box 521, Cedar Falls, IA 50613, (319) 277-6648. For more information circle number 361 on the Reader Service card.

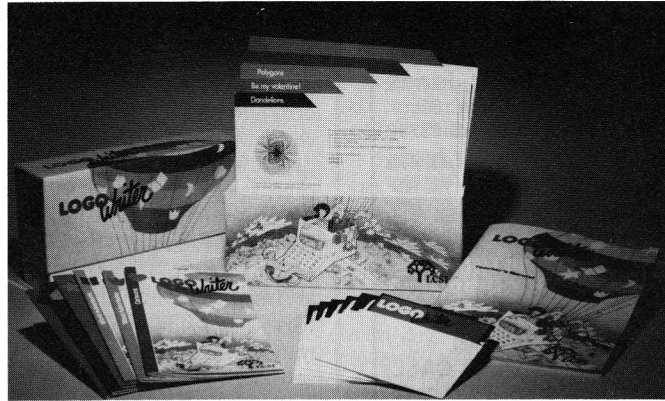

LogoWriter includes word processor, Logo, and extra materials.

Think It Out

The all-new Out-Think is a low-cost **outline processor** for CP/M computers. Out-Think lets you classify text into a familiar outline structure, then access and alter the text based on that structure. You can hide or highlight details as you like, or concentrate on the forest amidst the trees. Out-Think's full-screen text editor lets you control the text you insert or edit in your outline. Copy and move functions are supported, along with a host of other features, for \$49.95, from Kamasoft, 2525 Southwest 224th Avenue, Aloha, OR 97006, (503) 649-3765. For more information circle number 358 on the Reader Service card.

Roll Your Own

Gary Kitchen's GameMaker: The Computer Game Design Kit helps you **create your own computer games** without sophisticated programming languages or man-years of your time. Using a joystick, the "designer" selects from a menu of commands to create and animate charac-

ters and draw backgrounds. Sound effects and music can be included. Saving your masterpieces to blank disks for gifts—or sales—is easy. GameMaker costs \$39.95, from Activision, 2350 Bayshore Frontage Road, Mountain View, CA 94043, (415) 960-0410. For more information circle number 356 on the Reader Service card.

School Graphics

The Low Resolution Graphic Plotter lets students beginning computer programming and logic **create exciting graphics images and print them in low resolution** on the Apple II series. It's easy to use, and you can produce a full-page color-graphic design in about a minute. Almost all popular printers, including the new Apple ImageWriter II and Epson FX85, support the Low Resolution Graphic Plotter. The cost is an affordable \$39.95, from Burke Software, P.O. Box 515, Park Ridge, IL 60068, (312) 823-1357. For more information circle number 355 on the Reader Service card.

Playing War

Strategic Simulations has two new **simulations of historic battles and campaigns**: Nam (\$39.95), by Roger Damon, puts you into the thick of any of six vicious battles in the jungles of Southeast Asia; and BattleGroup (\$59.95), a sequel to Kampfgruppe, by Gary Grigsby, follows the Allied armies battling Hitler's forces in every major engagement from North Africa in 1943 through the war's climax in Germany. Three new **fantasies** demonstrate SSI's commitment to the genre: Phantasie II (\$39.95) takes you to the Isle of Ferronrah to fight Mikademus the Dark Lord; Rings of Zilfin (\$39.95) uses strong animated graphics to help you seek the missing rings and destroy the evil forces of Dragos; or you can wrest the pilfered Wizard's Crown (\$39.95) from behind enchanted walls in the fallen city of Arghan. All from Strategic Simulations, 883 Stierlin Road, Building A-200, Mountain View, CA 94043, (415) 964-1353. For more information circle number 357 on the Reader Service card.

Product descriptions contained in this section are based on information supplied to us by the respective manufacturers. These announcements are provided solely as a service to our readers and do not constitute endorsement by inCider of any given product.



PROFESSIONAL HANDICAPPING SYSTEMS



• PRESENTED BY PROFESSOR JONES •

GLD. Thoroughbred "Gold" Edition™

A "Full" featured thoroughbred analysis designed for the professional and the serious novice.
\$159.95 complete



EGLD. Enhanced "Gold" Edition™

"Gold" Edition with complete Master Bettor™ system integrated onto the same disk. This powerful program will transfer all horses and scores to the bet analysis with a "single keystroke."
(Master Bettor™ included) \$199.95 complete

GLTD. Limited "Gold"™

Enables Professional Handicappers to assign specific values to the racing variables they feel are important. Create program weight based on a particular track and line tune it for maximum win percentage. This program is designed for "ease of use". The user needs no programming experience.
(contains integrated Bettor™) \$299.95 complete



GD. Gold Dog Analysis™ \$149.95

The ONLY professional greyhound analysis available that evaluates ALL variables.
w/integrated Bettor \$199.95
Limited Version \$299.95

MHH. Master Harness Handicapper™



Professional software designed to provide a thorough analysis of all trotter and pacer races in the United States and Canada.
complete \$159.95
w/integrated Bettor \$199.95
Limited \$299.95

Professor Pix Football™

Complete STATISTICAL ANALYSIS on Data Base allowing "Designated" previous games to be evaluated.
Statistical Series \$99.95
w/Win-Loss Power Ratings \$149.95

NBA. Basketball™

NBA \$99.95 w/college \$129.95
w/power ratings \$149.95

LOT. Lottery Analysis™

Statistical comparison program designed to detect subtle patterns in winning numbers and digits.
Lottery (3-4 digit) \$79.95
w/Lotto (Max. 99 Digit) \$99.95

PC-3 Portable Computer (4k) w/choice of Thoroughbred, Greyhound or Trotter™ \$249.95 (includes portable computer & program.)

M-100 Portable (32k) w/choice of Thoroughbred, Greyhound, or Trotter and Master Bettor. \$649.95
(Includes portable computer and program.)

FREE CATALOG!

Circle 49 on Reader Service Card.

★★★★★

"Your BEST BET in handicapping software..."

Reviewed by: Whole Earth Software Guide
Corona Data Systems

Prof. Jones
1940 W. State
Boise, ID 83702



AMEX

48 HR. FREE SHIPPING

CALL
(208) 342-6939

TERMS: Free shipping all software. Add \$6.00 hardware/\$6.00 C.O.D. / UPS Blue \$6.00/Out of Country \$9.00/ID Residents 4%+3 weeks personal checks/Cash price only. add 2% Visa, MC, AMEX. Prices subject to change.

NEW PRODUCTS

The Last Word

LogoWriter is a **programmable word processor** for schools that lets children learn to program and to use applications, as well. Developed by Logo Computer Systems and Seymour Papert, creators of the original Logo language, LogoWriter is a powerful word processor and programming language. Children can write with it, draw with it, make music, and program: Each of LogoWriter's parts augments and simplifies the others. Best of all—for teachers with moral scruples and schools with tiny software budgets—a true-site license for LogoWriter, permitting unlimited copies in each school, costs only \$395 and includes extensive support materials. From Logo Computer Systems, 9960 Côte de Liesse Road, Lachine, Quebec, Canada, H8T 1A1, (514) 631-7081. For more information circle number 364 on the Reader Service card.

Strong Silent Type

Typing Made Easy is a **complete touch-typing course**. It has all the strengths of a conventional typing course coupled with the real advantages of the Apple computer. Eight lessons teach the keys a few at a time. You keep practicing keys you've already mastered while continuously learning new keys—as well as posture and other good habits. Best of all, you see nothing on screen until you complete the drill. Typing Made Easy costs \$59.95, from QED Information Sciences, P.O. Box 181, Wellesley, MA 02181, (617) 237-5656. For more information circle number 360 on the Reader Service card.

New Tricks

Quality Software's Bag of Tricks 2 is a completely new set of **disk-utility programs** that brings Apple II users all the programs of the original and more. For instance, ProDOS—not supported by the original—is fully covered in Bag of Tricks 2, as are 3½-inch floppies, hard disks, and RAM disks. Damaged disks can be repaired, lost directories restored, and disk data analyzed and modified. The 150-page manual contains useful examples and tutorials. Read and use the latest work of Don Worth and Peter Lechner, authors of *Beneath Apple DOS* and *Beneath Apple ProDOS*, for \$49.95 (5¼-inch disk) from Quality Software, 21601 Marilla Street, Chatsworth, CA 91311, (818) 709-1721. For more information circle number 363 on the Reader Service card.

Apple LaserWriter

Don Lancaster's LaserWriter/Apple Writer Utilities give you **superb //e text and graphics**. Apple desktop publishers will enjoy the automatic formatting, boxes and fancy borders, daisy-wheel changers, envelope and label routines, fast form letters, grids and rulers, hires converters, and numerous other features all available from Apple Writer. Who needs a Mac? Apple Writer does it all better and faster. The LaserWriter/Apple Writer Utilities retail for only \$39.95, from Synergetics, 746 First Street, Thatcher, AZ 85552, (602) 428-4073. For more information circle number 354 on the Reader Service card.

DIGITAL VISION

COMPUTEREYES™

VIDEO IMAGES ON YOUR COMPUTER!

Finally—an inexpensive way to capture real-world images on your computer's graphics display! COMPUTEREYES™ is an innovative slow-scan device that connects between any standard video source (video tape recorder, video camera, videodisk, etc.) and your computer. Under simple software control, a b/w image is acquired in less than six seconds. Unique multi-scan modes also provide realistic grey-scale images. Hundreds of applications!

Package includes interface module, complete easy-to-use software support on disk, owner's manual, and one year warranty all for \$129.95 plus \$4.00 S&H (USA).

Also available as a complete package including:

- COMPUTEREYES™
- Quality b/w video camera
- Connecting cable

for only \$399.95 plus \$9.00 S&H.

Demo disk available for \$10.00 postpaid (refundable).

See your dealer or order direct. Mass. residents add 5% sales tax. Mastercard, Visa accepted. To order, or for more information, write or call:



ONLY \$129.95

Available for:

- Apple II series
- Commodore 64/128
- Atari 800/800XL/65XE/130XE

DIGITAL VISION, INC.

14 Oak Street — Suite 2
Needham, MA 02192
(617) 444-9040, 449-7160

Product Updates

● Speaking of **Newsroom**: Scholastic Software (730 Broadway, New York, NY 10003, 212-505-3000) sells a **school edition** of the popular word processor and graphics combo for \$74.95.

● A new software technology—you saw it on the cover of the *Scientific American* "Software" special issue in September 1984—is being developed for the Apple II series. "**Grasp**" technology, developed by VPL Research in Palo Alto, California, is a visual programming language operated by a glove-input device. Grasp technology uses pictures, sound, and animation to create visual effects in real time. Curious? Call Share-Data, 7122 Shady Oak Road, Eden Prairie, MN 55344, (612) 829-0409.

● It's true: **UCSD Pascal**—with lots of improvements—is now to be had at Pecan Software Systems, 1410 39th Street, Brooklyn, NY 11218, (718) 851-3100. Forget SofTech Microsystems—this is the true-blue real-McCoy p-system Pascal.

● Manzanita has released the **Accounts Receivable Works** (\$395) and has announced that BusinessWorks works with all kinds of RAM cards—Applied Engineering, AST, and Apple—and the ever-popular Pinpoint. One Sierra Gate Plaza, Suite 200-A, Roseville, CA 95678, (916) 781-3880.

● Need **RamWorks** help? Applied Engineering's new tech-support number is (214) 241-6069. Sales are still at P.O. Box 798, Carrollton, TX 75006.

● How about an animated murder mystery that stars some heavies—and heroes—from classic films of the Forties, and can be played over and over again? Intrigued? Call Kinematation at (603) 924-3076 in Peterborough, New Hampshire, and ask about **Intrigue**.

● The **SwyftCard** is growing up. Not only does Information Appliance have a new address (1014 Hamilton Court, Menlo Park, CA 94024, 415-328-5166), but it's produced a baby sibling for the SwyftCard—**SwyftCard //c**.

● The latest **Let's Talk** from Russ Systems (320 Dufour Street, Santa Cruz, CA 95060, 408-427-1540) offers an AppleWorks data-base search and networking capability for up to 63 users.

● Logo fans tired of high tech, try this high-touch turtle: a soft, cuddly **turtle hand puppet** that obeys all your commands. \$19 for a pettable pair. K-12 MicroMedia, 6 Arrow Road, Ramsey, NJ 07446, (800) 922-0401.

● Pinpoint now pops a **spelling checker** into AppleWorks—you get a 55,000-word dictionary, as many as ten alternative spellings, and instant re-formatting in AppleWorks. Pinpoint and the Spelling Checker are \$69 each. Take both for \$125, and some of the nicest people in the Apple world will throw in the \$20 RAM-enhancement kit at no cost. From Pinpoint Publishing, P.O. Box 13323, Oakland, CA 94661, (415) 654-3050.

● Still think Springboard's **Newsroom** is a printing press for kids? Well, it is, but check out the **Clip Art Collection, Volume 2**, with 800 illustrations designed for publications in businesses large and small—medicine, accounting, finance, computers, and lots of serious stuff. From Springboard Software, 7807 Creekridge Circle, Minneapolis, MN 55435, (612) 944-3915.

● Star Trekkers befuddled by the microcomputer game of that name might be beamed up by the helpful **Star Trek Hints** offered by Simon & Schuster, 1230 Avenue of the Americas, New York, NY 10020, (212) 245-6400.

APPLE(II+)WORKS™ PLUS-WORKS™

It really Works!!

PLUS-WORKS not only allows you to have all features of AppleWorks™ on an Apple II™, II+ or compatible, but our extended memory versions give you capabilities far beyond the standard IIe/c versions. Its great for expansion on the Apple IIe as well.

Compare these features with other AppleWorks patch programs

- Copyable - make backups, transfer to hard disk
- Up to 1 megabyte of desktop space available
- Database expansion to more than 4,200 records
- All IIe control codes available to printer with any keyboard
- Supports Franklin computers and all full ASCII keyboards
- Supports all major 80 column cards
- Permanent and dynamic ram disk features
- All versions of AppleWorks supported, even V1.3
- Optional patch to help with printer problems

• **PLUS-WORKS** - \$19.95 plus \$3.00 ship/hand. Requires AppleWorks, 64K Apple II+ or compat, 80 col card and shift key mod. Maximum desktop 10K. Upgrade to XM for \$30.00 Special Laser 3000 10K only version available (Plus-Works-L)

• **PLUS-WORKS-XM** - \$49.95 plus \$3.00 ship/hand. Requires same as above with legend, saturn, or compatible ram card (Big board, know drive, prometheus, etc), Apple's memory card, Microtek, Orbital, PCPI & Micropro CP/M, IBS AP33, or Apple IIe with peripheral slot ramcard. Special Basis 108 version available (PLUS-WORKS-XMB)

PLUS-WORKS-XM & 256K Apple mem card (expandable to 1 meg) - \$295.00

MC/Visa add 4%

Orders only 1-800-221-3826

Information & NJ residents call 516-922-9584

or send check or money order to:

Norwich Data Services Ltd.
PO Box 356 • E. Norwich, NY 11732

NYS residents add sales tax

Apple & Appleworks are trademarks of Apple Computer Corp.
PLUS-WORKS is a trademark of Norwich Data Services Ltd.

HAVING TROUBLE REMEMBERING ALL THE COMMANDS FOR YOUR PROGRAMS??

YOU NEED

LEROY'S CHEATSHEET®

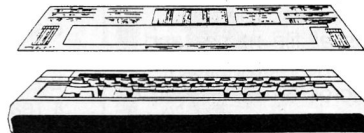

KEYBOARD OVERLAYS FOR THE
Apple® IIe & IIc

THE QUICK AND EASY SOFTWARE DOCUMENTATION

Forget about constantly referring back to the manual for operating commands. Discover all the "special" commands buried in the manuals. LEROY'S CHEATSHEETS are sturdy plastic laminated help sheets designed for use with popular software, hardware and languages for APPLE IIe & IIc computers. Commands are grouped together for logical use. You learn and use your programs faster and easier.

IIe Cheatsheets are **DIE CUT** overlays designed to fit over the keyboard

only
\$5.95
each

IIc Cheatsheets are 7 x 10 1/2 reversible plastic laminated reference cards

With LEROY'S CHEATSHEETS® you will never have to hunt for a command again.

APPLEWORKS
APPLE WRITER II (ProDOS)
BASIC (Dos 3.3)
BASIC (PRODOS)
BLANKS (SET OF 3)
FLIGHT SIMULATOR II
FOR THE BEGINNER (DOS 3.3)
GRAPPLER +
LOGO (APPLE)
LOGO (TERRAPIN)
MULTIPLAN
PRACTICALC II
SCREENWRITER II
SPEEDSCRIPT
SUPERBASE
VISICALC

IMAGewriter
EPSON RX & FX 80
GEMINI 10X & 15X
OKIDATA 92 & 93

IIe (overlay) IIc (card)

QTY. _____ X \$ 5.95 = \$ _____

SHIPPING \$ 1.00*

* U.S. & CANADA \$1.00 (PA. ONLY)
FOREIGN ORDERS \$3.00
CHECK, M.O., MC/VISA
U.S. FUNDS NO C.O.D. TOTAL \$ _____

MC/VISA # _____
EXPIRATION DATE _____
NAME _____
ADDRESS _____
CITY _____
STATE _____ ZIP _____

CHEATSHEET PRODUCTS INC.
P.O. Box 111368 Pgh., PA 15238
(412) 781-1551 5cldr

CIRCLE YOUR CHOICE

HINTS/TECHNIQUES

Apple users know that there's always an easier way to get the job done. A shortcut here, an elegant twist there. That's what *Hints/Techniques* is all about. It's an information swap for readers who want to share their programming pointers, DOS tips, hardware secrets, AppleWorks applications, WPL enhancements, and all those other insights that make you go "Aha!" in the night. So read on and see if you don't find just the solution you've been looking for.

ProDOS Cataloger

by Ed Verdelotti

Cataloging all your ProDOS program disks in a master file is one boring, laborious task. If you've got better things to do with your time, let ProDOS Filer rescue you. ProDOS Filer reads the file names in the volume directories—and subdirectories—of your program disks and stores them in text files. Then it merges and sorts *all* file names and places them into one master file, which you can scroll on the screen or send to your printer to create a disk catalog.

Before ProDOS Filer will work properly, you must do two things to the disk on which you plan to save the **Program listing:** Rename the volume /CATALOG/ and create a directory called VOLUMES by using the command CREATE/CATALOG/VOLUMES. (Refer to the *ProDOS User's Manual* for information about renaming volumes and creating directories.) To use different volume and directory names, make the appropriate changes in the string variables in line 170. This is important because the program as it stands looks for /CATALOG/VOLUMES before it saves or retrieves files.

You can use the program with one or two drives without any modification. If your system has only one drive,

Table 1. ProDOS Filer menu options.

Option	Description
1	Catalog a disk
2	Read a disk catalog
3	Update master file
4	Read master file
5	Print master file
6	Delete a disk catalog
7	Exit program

ProDOS Filer prompts you when you need to change disks. If you have a two-drive system, it's best to leave the /CATALOG/ disk in drive 2 after you load the program.

Program Options

Table 1 illustrates the program's menu options; Table 2, the corresponding program lines. The subdirectory VOLUMES is initially empty, so your first step is to use option 1 to read the directories of the ProDOS disks you want to catalog. The program prompts you to put the disk to be cataloged into drive 1. Then, after it reads the disk's directories, it prompts you to insert the /CATALOG/ disk into drive 1 (unless it has already found that disk in drive 2). Repeat

Table 2. ProDOS Filer line descriptions.

Lines	Function
100-190	Initialize
200-340	Program menu
350-710	Read disk catalogs
720-970	Read volume directories
980-1180	Read subdirectories
1190-1360	Save disk catalogs
1370-1440	Delete disk catalogs
1450-1650	Update master file
1660-1860	Sort routine
1870-2070	Display master file
2080-2260	Print master file
2270-2350	Error trapping

this process until ProDOS Filer has cataloged all your ProDOS volumes.

Once you've created this master file, you can do several things. First, you can read the file names from any of the individual volumes—simply select option 2. ProDOS Filer catalogs the VOLUMES directory and asks which volume you want to read, then scrolls on screen the file names contained on that volume and lists any subdirectory names after the file name and type.

With option 3, you can update the master file. The program loads the file names of all the volumes into an array that will hold up to 500 files, then sorts them and saves the sorted files in MASTER.FILE.

Option 4 lets you read the master file. ProDOS Filer displays 21 sorted file names at a time on your screen until it has scrolled through the entire master file. You can then scroll again or exit the routine. Along with the file name and type, the program displays the file's volume (and subdirectory if applicable).

If you want a hard-copy catalog of your master file, choose option 5. The program doesn't use any unique printer codes, so the printer routine is as compatible as possible with the various printer/interface configurations. The program assumes your printer interface is in slot 1. If it isn't, change the slot number in line 2150. At six lines per inch, ProDOS Filer prints a two-line header, 60 file names, and four blank lines (see the **Figure**). It then repeats the header at the top of the next page and prints the next 60 file names.

Option 6 deletes any volumes you no longer use. When you type in the name of the file, the program removes it from the VOLUMES directory. It isn't necessary to delete a volume you're updating with option 1,

Program listing. ProDOS Filer.

```

100 REM =====
110 REM *** PRODOS FILER ***
120 REM BY ED VERDELOTTI
130 REM 5/1/85
140 REM =====
150 REM <<===== MENU =====>>
160 PRINT CHR$(21);D$ = CHR$(4)
170 VOL$ = "/CATALOG/";DIR$ = "VOLUMES"
180 DIM A$(75),L$(50),SD$(25),MF$(500)
190 ONERR GOTO 2280
200 TEXT : HOME :MF = 0
210 FOR I = 1 TO 40: PRINT "=";: NEXT I
220 HTAB 14: INVERSE : PRINT "DISK FILER MENU": NORMAL
230 FOR I = 1 TO 40: PRINT "=";: NEXT I: PRINT
240 VTAB 6: HTAB 10: PRINT "(1) = CATALOG A DISK"
250 PRINT : HTAB 10: PRINT "(2) = READ A DISK CATALOG"
260 PRINT : HTAB 10: PRINT "(3) = UPDATE MASTER FILE"
270 PRINT : HTAB 10: PRINT "(4) = READ MASTER FILE"
280 PRINT : HTAB 10: PRINT "(5) = PRINT MASTER FILE"
290 PRINT : HTAB 10: PRINT "(6) = DELETE A DISK CATALOG"
300 PRINT : HTAB 10: PRINT "(7) = EXIT PROGRAM"
310 PRINT : HTAB 10: PRINT "ENTER SELECTION (1-7)-> ";: GET
A$
320 A = VAL (A$): IF A < 1 OR A > 7 THEN 240
330 ON A GOTO 730,360,1460,1880,2090,1380,340
340 PRINT D$"PREFIX";VOL$: HOME : END
350 REM <<===== SEE DISK FILES =====>>
360 PRINT
370 PRINT D$"PREFIX";VOL$:DIR$
380 TEXT : HOME :T = 0
390 PRINT D$"CAT"
400 INPUT "READ WHICH CATALOG (E=EXIT) ?";N$: IF ASC (N$) <
65 OR ASC (N$) > 90 THEN V = PEEK (37): VTAB V: CALL -
868: GOTO 400
410 IF N$ = "E" THEN 200
420 IF N$ = "MASTER.FILE" THEN 1880
430 PRINT D$"VERIFY";N$
440 HOME : VTAB 2:B$ = ""
450 SP$ = ""
460 PRINT D$"OPEN ";N$
470 PRINT D$"READ ";N$
480 INPUT PR$: INPUT FMAX
490 FOR I = 1 TO FMAX
500 INPUT A$(I)
510 IF A$(I) = CHR$(13) THEN I = FMAX GOTO 520
520 NEXT I:B$ = ""
530 FOR I = 1 TO 40: GET A$:B$ = B$ + A$: NEXT I
540 PRINT D$"CLOSE"
550 IF MF = 1 THEN RETURN
560 PRINT PR$;" ";FMAX;" FILES";: HTAB (25): PRINT "SUBDIRE
CTORY"
570 FOR I = 1 TO 40: PRINT "-";: NEXT I
580 POKE 34,3: PRINT
590 FOR I = 1 TO FMAX
600 T = T + 1
610 A = 21:SP$ = " ": IF LEFT$(A$(I),1) = "*" THEN A = 22:S
P$ = " "
620 Y = LEN (PR$):A$(I) = LEFT$(A$(I),20) + SP$ + MID$(A
$(I),A + Y,14)
630 IF I < 10 THEN PRINT " ";
640 PRINT I;"::": IF LEFT$(A$(I),1) < > "*" THEN PRINT "
";
650 PRINT A$(I)
660 IF T = 18 THEN PRINT "ANY KEY TO CONTINUE": GET A$:V =
PEEK (37): VTAB V: CALL - 868:T = 0
670 NEXT I
680 PRINT : PRINT SP$
690 PRINT "ANY KEY TO CONTINUE 'E' TO EXIT";: GET A$
700 IF A$ = "E" THEN 200
710 GOTO 380
720 REM <<===== SAVE DISK CATALOG =====>>
730 HOME : VTAB 10: HTAB 5: PRINT "PUT DISK TO CATALOG IN DR
IVE #1"; CHR$(7)
740 VTAB 20: INVERSE : PRINT " ANY KEY TO CONTINUE OR 'E' TO
EXIT ";: NORMAL : GET A$
750 IF A$ = "E" THEN 200
760 PRINT D$"PREFIX,D1": PRINT
770 PRINT D$"PREFIX"
780 HOME : VTAB 8
790 INPUT "VOLUME NAME";PR$: HTAB 15: INVERSE : PRINT PR$: NORMAL
: PRINT
800 A$ = MID$(PR$,2, LEN (PR$) - 2)
810 HTAB 5: PRINT "CATALOGING VOLUME : ";A$: PRINT
820 FMAX = 0:N = 1
830 PRINT D$"OPEN";PR$,"TDIR"
840 PRINT D$"READ";PR$
850 INPUT L1$: REM READ NAME
860 INPUT L2$: REM READ TITLE

```

Listing continued.

FREE?DISKETTES

SAVE MONEY! Apple II series users can use the diskette flip side, if another "write enable" notch is correctly made.

TOP NOTCH by QUORUM quickly SOLVES that PROBLEM.

It's like FREE DISKETTES!

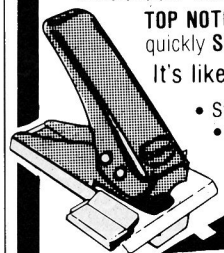

- Stainless Steel Guide
- Easy Leverage Handle
- Clippings Catcher
- Square Notch Cut
- Black Finish

Lifetime Warranty

Awarded the only A+ GRADE in a comparison test published by the INTERNATIONAL APPLE CORE.

"The best I've found..."

IAC Reviewer

Certifix™

BE SAFE! The flipside of a single sided disk may have flaws. Any disk is CERTIFIED 100% ERROR FREE with CERTIFIX. IT "LOCKS OUT" BOTH DOS 3.3 & ProDOS DISK FLAWS.

- LOCKS OUT ProDOS & DOS 3.3 FLAWS
- SAVES STATUS REPORT ONTO DISK
- AUTOMATIC ProDOS/3.3 FORMATTING
- CREATE 40 trk DISKS & SYSTEM MASTER
- RECORDS TEST DATE onto disk
- NOT COPYPROTECTED

FREE CERTIFIX BONUS PROGRAMS

- Undelete DOS 3.3 files
 - Test and Adjust Disk Drive Speed
- Prevent Data Loss!
CERTIFY & FIX every disk with CERTIFIX!



Get THE BEST!

Ask our Customers;

U.S. National Bureau of Standard
TRW • IBM • Digital Research • AT&T
U.S. Naval Weapons Research Center
Alcoa • Rockwell International
General Electric Corporation

FREE!

64 Write Protect Tabs
32 Diskette Labels
If you get the
DISKETTE FLIP-KIT
which contains
TOP NOTCH and CERTIFIX

100% Money Back
Satisfaction Guarantee!

DISKETTE FLIP-KIT only \$29.95
TOP NOTCH is \$14.95
CERTIFIX is just \$24.95
Add \$2 s/h • CA add 6.5% tax

For your nearest dealer
or to order direct.

CALL TOLL FREE
1-800-222-2824
In CA: 1-800-222-2812
From 8 am - 5 pm PST



Dealers Invited

QUORUM INTERNATIONAL, Unltd.
INDUSTRIAL STATION P O BOX 2134 IC
OAKLAND, CA 94614

Enhance AppleWorks™

DMP Utilities lets you use new character typefaces with AppleWorks. Now you can get Italics, Greek, Symbols, the highest quality typeface we've ever seen, and many other fonts, all from within AppleWorks!!!

24 Imagewriter Fonts 20 Epson FX/JX Fonts

DMP Utilities includes menu-driven software to download the character sets, and to eliminate printer control problems forever. You also get a character editor (full descender, proportional ability) and a program to convert some of the many hi-res character sets for printer use.

DMP Utilities is supplied on DOS 3.3, unlocked, and includes a 67 page User's Manual. Because the fonts are downloaded, they work with any program, not just AppleWorks. Our no-risk warranty provides you a full refund if you're not happy with the programs. The Utilities costs \$50 (+\$2 p/h). MC/Visa gladly accepted

DMP Utilities works *ONLY* with Apple DMP, Imagewriter I or II, and Epson FX or JX printers.

*Apple Imagewriter Trademark of Apple Computer, Inc.
Epson is a Trademark of the Epson Corp.*

Vilberg Brothers Comp. Inc.
4201 Hegg Avenue
Madison, WI 53716
(608) 221-0842

Circle 135 on Reader Service Card.

The Best Ever Assembled! MERLIN PRO

The most popular macro assembler
for the 128K Apple IIe and IIc

2 Disks: DOS 3.3 and ProDOS
2 Editors: Standard & Full Screen
Supports 6502, 65C02 and 65802
Relocating Linker & Macro Library
Sourceror - a symbolic disassembler
Commented Applesoft source listing
Unprotected & hard disk compatible
One powerful package,
One easy price **\$99.95**

ASSEMBLY LINES: THE BOOK by Roger Wagner

Designed for the novice, this book
teaches Apple assembly language
programming in plain English.

Disk access routines
Simple math operations
Reading and writing files
Keyboard and screen techniques
Sound generation routines
6502 command reference section
Let this best-seller
get you up and running. **\$19.95**

See your Apple dealer or call

Roger Wagner
PUBLISHING, INC.

1-800-421-6526 Ext. 193
In CA call 619-562-3670

More info available on request

Apple is a trademark of Apple Computer, Inc.

HINTS/TECHNIQUES

since the program deletes the old file and replaces it with the updated file.

Additional Notes

As written, ProDOS Filer disregards any system files (SYS) it finds on your disks. To include system files in your catalog, delete line 920.

To stay within the limits of the 40-column screen, the program hyphenates any combinations of volume and subdirectory names that would cause a line to exceed 39 characters.

So stop procrastinating—cataloging's easy with ProDOS Filer. ■

Write to Ed Verdelotti at 216 Missimer Lane, Vinton, VA 24179.

Got a hint of your own? inCider would like to see it. If we can use it in Hints/Techniques, we'll buy it from you. Send your tip to inCider, 80 Pine Street, Peterborough, NH 03458.

Figure. One page of a printed master catalog.

FILE NAME	TYPE	VOL.DIR./SUBDIR.	NOTES
ADDRESS	BAS	/EXAMPLES/PROGRAMS	
*APA	BIN	/UTILITY/	
*APA	BIN	/EXAMPLES/EXTRAS	
APPLESOFT	TXT	/EXAMPLES/PROGRAMS	
APPLESOFT	TXT	/VISI.DATA/	
APPLESOFT.PROG	BAS	/EXAMPLES/DIRECTO-	
APPLESOFT.VARS	VAR	/EXAMPLES/DIRECTO-	
ASSEMBLY	TXT	/VISI.DATA/	
BINARY	BIN	/EXAMPLES/DIRECTO-	
BLACK.BOOK	TXT	/EXAMPLES/DATA	
CATALOG	TXT	/EXAMPLES/PROGRAMS	
*CONFIG.GPLE	BAS	/UTILITY/	
DIRECTORY	DIR	/EXAMPLES/DIRECTO-	
DISCARD	TXT	/UTILITY/	
DISK.FILER	BAS	/UTILITY/	
*ESCAPE.PRINTER	BIN	/UTILITY/	
ESCAPE.SAVE	BAS	/UTILITY/	
FILE.SAVER	BAS	/VISI.DATA/	
GAMES	TXT	/VISI.DATA/	
GET.FILES	BAS	/VISI.DATA/	
GET.TEXT	BAS	/EXAMPLES/PROGRAMS	
*GPLE	BIN	/UTILITY/	
GRAPHICS	TXT	/VISI.DATA/	
HARDWARE	TXT	/VISI.DATA/	
*HELP	BIN	/EXAMPLES/	
*HELPSCREENS	TXT	/EXAMPLES/	
LISTFILE	TXT	/EXAMPLES/DATA	
MAKE.TEXT	BAS	/EXAMPLES/PROGRAMS	
MEM.FILLER	BAS	/UTILITY/	
MENU	BAS	/UTILITY/	
MISC	TXT	/VISI.DATA/	
PICTURE	BIN	/EXAMPLES/DATA	
POKER.EXEC	TXT	/EXAMPLES/DATA	
*POSTAGE.RATES	BAS	/EXAMPLES/EXTRAS	
*PRODOS.FILER	BAS	/CATALOG/	
PROGRAMS	TXT	/VISI.DATA/	
*READ.DIRECTORY	BAS	/EXAMPLES/EXTRAS	
REF.1	TXT	/VISI.DATA/	
REF.FILE.1	TXT	/EXAMPLES/	
REFERANCE	TXT	/EXAMPLES/PROGRAMS	
REFERENCE	TXT	/EXAMPLES/DATA	
REFERENCE	BAS	/EXAMPLES/	
RELOC.CODE	REL	/EXAMPLES/DIRECTO-	
*REMOVE.GPLE	BIN	/UTILITY/	
*RRC	BIN	/UTILITY/	
SCREEN	BIN	/UTILITY/	
SHOWOFF.EXEC	TXT	/EXAMPLES/DATA	
SOFT.REV	TXT	/VISI.DATA/	
SORT.PROGRAM	BAS	/EXAMPLES/	
SORTED.TEXT	TXT	/EXAMPLES/	
SPLT.SCREEN	BIN	/UTILITY/	
STARTUP	BAS	/UTILITY/	
*STARTUP	BAS	/CATALOG/	
STARTUP	BAS	/VISI.DATA/	
*STARTUP	BAS	/EXAMPLES/	
SYSTEM.PROGRAM	SYS	/EXAMPLES/DIRECTO-	
TC	TXT	/VISI.DATA/	
TEXT	TXT	/EXAMPLES/DATA	
TEXT	TXT	/EXAMPLES/DIRECTO-	
TEXT.GEN	BAS	/EXAMPLES/	

Listing continued.

```
870 INPUT L3$: REM READ BLANK LINE
880 FOR I = 1 TO 50
890 INPUT L$(I): IF L$(I) = "" THEN I = 50: GOTO 940
900 L$(I) = LEFT$(L$(I),20) + " " + PR$: REM READ FILES
910 IF MID$(L$(I),18,3) = "DIR" THEN GOSUB 1170:SD$(N) =
MID$(L$(I),2,X):N = N + 1: GOTO 890
920 IF MID$(L$(I),18,3) = "SYS" THEN 890
930 FMAX = FMAX + 1
940 NEXT I
950 INPUT L5$: REM READ BLOCK COUNT
960 PRINT D$"CLOSE"
970 ON MF GOTO 1190
980 IF N < 2 THEN 1190
990 FOR T = 1 TO N - 1
1000 F = FMAX + 1
1010 IF LEFT$(SD$(T),7) = DIR$ THEN 1150
1020 PRINT D$"OPEN";SD$(T),"TDIR"
1030 PRINT D$"READ";SD$(T)
1040 INPUT L1$
1050 INPUT L2$
1060 INPUT L3$
1070 FOR I = F TO F + 25
1080 INPUT L$(I): IF L$(I) = "" THEN I = F + 25: GOTO 1120
1090 L$(I) = LEFT$(L$(I),20) + " " + PR$ + SD$(T)
1100 REM X = LEN(L$(I)): IF X > 39 THEN L$(I) = LEFT$(L
$(I),39) + "-"
1110 FMAX = FMAX + 1
1120 NEXT I
1130 INPUT L5$
1140 PRINT D$"CLOSE"
1150 NEXT T
1160 GOTO 1190
1170 FOR T = 1 TO 16:B$ = MID$(L$(I),1 + T,1): IF B$ = " "
THEN X = T - 1:T = 16
1180 NEXT T: RETURN
1190 N = 1
1200 PRINT D$"PREFIX";VOL$;DIR$
1210 N = 0: IF "/" + A$ = VOL$ + DIR$ THEN 1290
1220 HTAB 8: PRINT "SAVING "A$;" TO DISK"
1230 PRINT D$"OPEN";A$
1240 PRINT D$"CLOSE";A$
1250 PRINT D$"DELETE";A$
1260 PRINT D$"OPEN";A$
1270 PRINT D$"WRITE";A$
1280 PRINT PR$: PRINT FMAX
1290 FOR I = 1 TO FMAX: PRINT L$(I): NEXT I
1300 IF MF = 1 THEN RETURN
1310 PRINT L5$
1320 PRINT D$"CLOSE"
1330 HOME: VTAB 8: HTAB 9: PRINT " CATALOG ANOTHER DISK ? "
1340 VTAB 11: HTAB 14: PRINT "ENTER (Y/N) ";: GET A$: IF A$ =
"N" THEN 200
1350 IF A$ < > "Y" THEN 1330
1360 GOTO 720
1370 REM <<===== DELETE A VOLUME FILE =====>>
1380 PRINT D$"PREFIX";VOL$;DIR$: TEXT: HOME
1390 PRINT D$"CAT"
1400 INPUT "ENTER VOLUME TO DELETE (E=EXIT) ? ";N$: IF ASC
(N$) < 65 OR ASC(N$) > 90 THEN V = PEEK(37): VTAB V:
CALL - 868: GOTO 190
1410 IF N$ = "E" THEN 200
1420 PRINT D$"VERIFY";N$
1430 PRINT D$"DELETE";N$
1440 GOTO 200
1450 REM <<===== UPDATE MASTER FILE =====>>
1460 HOME: MF = 1
1470 PRINT D$"PREFIX";VOL$;DIR$
1480 PRINT D$"OPEN MASTER.FILE"
1490 PRINT D$"CLOSE MASTER.FILE"
1500 PRINT D$"DELETE MASTER.FILE"
1510 GOSUB 770: HOME
1520 L = FMAX:FMAX = 0:N = 0:P = 0:SP$ = " "
1530 VTAB 2: HTAB 10: PRINT "UPDATING MASTER FILE"
1540 FOR I = 1 TO 40: PRINT "-";: NEXT I
1550 FOR F = 1 TO L
1560 N$ = L$(F): IF MID$(N$,18,3) < > "TXT" THEN 1650
1570 N$ = LEFT$(N$,15): HTAB 15: PRINT N$
1580 GOSUB 450
1590 FOR I = 1 TO FMAX
1600 IF LEFT$(A$(I),1) < > "*" THEN A$(I) = " " + A$(I)
1610 Y = LEN(A$(I)): IF Y > 39 THEN A$(I) = LEFT$(A$(I),3
8) + "-"
1620 MF$(N + I) = A$(I)
1630 IF I + N = > 500 THEN N = N + I:F = L:I = FMAX: PRINT
"CATALOG FULL": FOR I = 1 TO 1000: NEXT I: GOTO 1650
1640 NEXT I:N = N + FMAX
1650 NEXT F:FMAX = N
1660 REM <<===== SORT ROUTINE =====>>
1670 I = 1
1680 I = 2 * I: IF I < = FMAX THEN 1680
```

Listing continued.

And your Earls and Viscounts. If you've got royal ancestors, we have the noble software that can help you trace them down.

Family Roots and your Apple, IBM, Commodore, Kaypro*, and many others, offer individual and group sheets, charts, name indices, general search and text

Put up your dukes!

capabilities. Adapts to most disk drives, printers, and screens. You get more utility programs, plus lots of personal control. A comprehensive (new) manual is included.

All for just \$185.

Write or call today for more information and a free brochure.



Quinsept, Inc.

P.O. Box 216
Lexington, MA 02173
(617) 641-2930

American Express,
Visa, and MasterCard
gladly accepted.

* Trademarks for Apple
Computer Inc., International
Business Machines, CBM, Inc.
and Digital Research.

Circle 16 on Reader Service Card.

WITHOUT UNIDOS,TM YOUR UNIDISKTM JUST WON'T RECOGNIZE AN OLD FRIEND.

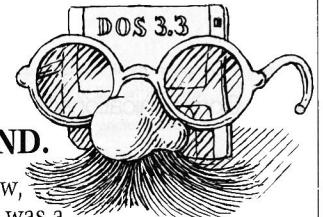

Until now, DOS 3.3 was a stranger to your Apple UniDisk 3.5. But no more!

UniDOS is DOS 3.3 for your UniDisk. It lets your UniDisk function as a dual 400k disk drive system while you work with your favorite DOS 3.3 programs and data.

Introduce UniDOS to your UniDisk right away. At \$35.00 they'll become fast friends.

meacom

P.O. Box 272591, Houston, TX 77277
(713) 526-5706, Telex: 4945935

VISA and MC accepted. UniDOS is written by David Hemmo and Marc Moini. For Macintosh Owners: Meacom also offers Mac + II, an AppleIIe emulator (128k, 80 column) for your 512k Mac or MacPlus. UniDisk 3.5 and Macintosh are trademarks of Apple Computer, Inc. UniDOS is a trademark of Meacom.

ATTENTION

We occasionally make our mailing list available to other companies or organizations with products or services which we feel might be of interest to you. If you prefer that your name be deleted from such a list, please fill out the coupon below or affix a copy of your mailing label and mail it to:

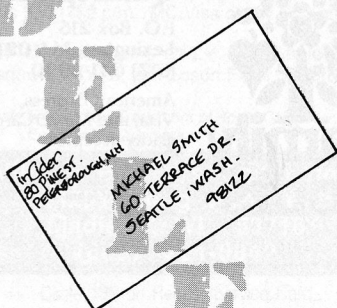

C.W. Communications/Peterborough
inCider
PO Box 911
Farmingdale, NY 11737

Please delete my name from mailing lists sent to other companies or organizations.

name _____
address _____
city _____ state _____ zip _____
inCider

Listing continued.

```

1690 I = INT ( I / 2 ) : IF I = 0 THEN 1780
1700 HOME : VTAB 10 : HTAB 12 : PRINT "SORTING ";FMAX;" FILES"
1710 FOR F = 1 TO FMAX - 1
1720 A = F
1730 L = I + A : IF L > FMAX THEN 1760
1740 IF MID$( MF$(A),2,14) > MID$( MF$(L),2,14) THEN A$ =
MF$(A) : MF$(A) = MF$(L) : MF$(L) = A$ : A = A - 1 : IF A > 0 THEN
1730
1750 VTAB 14 : HTAB 10 : PRINT "PASS ";P;" SORTS/PASS ";F
1760 NEXT : P = P + 1
1770 GOTO 1690
1780 HOME : VTAB 10 : HTAB 10 : PRINT "SAVING MASTER FILE"
1790 PRINT D$"OPEN MASTER.FILE"
1800 PRINT D$"WRITE MASTER.FILE"
1810 PRINT PR$: PRINT FMAX
1820 FOR I = 1 TO FMAX
1830 PRINT MF$(I)
1840 NEXT I
1850 PRINT D$"CLOSE"
1860 GOTO 200
1870 REM <<===== SEE MASTER FILE =====>>
1880 PRINT D$"PREFIX";VOL$;DIR$
1890 PRINT D$"VERIFY MASTER.FILE"
1900 HOME : PRINT D$"OPEN MASTER.FILE"
1910 PRINT D$"READ MASTER.FILE"
1920 INPUT PR$: INPUT FMAX
1930 FOR I = 1 TO FMAX
1940 INPUT MF$(I)
1950 NEXT
1960 PRINT D$"CLOSE"
1970 IF PR = 1 THEN RETURN
1980 HOME : L = 0
1990 FOR I = 1 TO FMAX
2000 IF LEFT$( MF$(I),1) < > "*" THEN PRINT " ";
2010 PRINT MF$(I)
2020 L = L + 1
2030 IF L = 21 THEN HTAB 10 : INVERSE : PRINT "ANY KEY TO CO
NTINUE" : NORMAL : GET A$:V = PEEK (37) : VTAB V : CALL -
868 : L = 0
2040 NEXT I : PRINT : HTAB 10 : PRINT "***** ";FMAX;" FILES **
***" : PRINT
2050 INVERSE : PRINT "* END OF LIST * SCROLL AGAIN? (Y/N) " :
NORMAL : GET A$
2060 IF A$ = "Y" THEN 1980
2070 GOTO 200
2080 REM <<===== PRINT MASTER LIST =====>>
=>>
2090 PRINT D$"PREFIX";VOL$;DIR$
2100 PRINT D$"VERIFY MASTER.FILE"
2110 HOME : L = 0 : PR = 1 : GOSUB 1900
2120 SP$ = " " : REM 20 SPACES
2130 VTAB 10 : HTAB 13 : INVERSE : PRINT " PRINTER ON 11 " : CHR$
(7) : NORMAL
2140 VTAB 12 : HTAB 10 : PRINT "ANY KEY TO CONTINUE" : GET A$
2150 PRINT D$"PR#1" : REM ACTIVATE PRINTER (SLOT #1)
2160 PRINT " FILE NAME TYPE VOL.DIR./SUBDIR. NOTE
S"
2170 FOR I = 1 TO 79 : PRINT "-"; : NEXT I : PRINT
2180 IF L > 1 THEN L = 0 : RETURN
2190 FOR F = 1 TO FMAX
2200 L = L + 1
2210 IF LEFT$( MF$(F),1) < > "*" THEN MF$(F) = " " + MF$(F)
)
2220 P = 39 - LEN ( MF$(F) ) : IF P > 1 THEN MF$(F) = MF$(F) +
LEFT$( SP$,P)
2230 PRINT " ";MF$(F);"
": REM 37 ' '
2240 IF L > 59 THEN PRINT : PRINT : PRINT : PRINT : GOSUB 2
160
2250 NEXT
2260 PRINT D$"PR#0" : PR = 0 : GOTO 200
2270 REM <<===== ONERR ROUTINES =====>>
2280 PRINT D$"CLOSE" : HOME
2290 IF PEEK (222) = 6 AND N = 1 THEN HOME : VTAB 10 : HTAB
7 : PRINT "INSERT CATALOG FILER DISK " : VTAB 15 : HTAB 10 :
PRINT "ANY KEY TO CONTINUE"; : GET B$ : GOTO 1200
2300 IF PEEK (222) = 6 THEN VTAB 10 : HTAB 10 : PRINT " PATH
NOT FOUND " : FOR I = 1 TO 1500 : NEXT I : GOTO 190
2310 IF PEEK (222) = 7 THEN HOME : VTAB 10 : HTAB 7 : PRINT
"NO SUBDIRECTORY PATH FOUND" : VTAB 15 : HTAB 10 : PRINT "A
NY KEY TO CONTINUE"; : GET B$ : GOTO 190
2320 IF PEEK (222) = 8 THEN HOME : VTAB 10 : HTAB 7 : PRINT
"NO DISK FOUND IN DRIVE #1 " : VTAB 15 : HTAB 10 : PRINT "A
NY KEY TO CONTINUE"; : GET B$ : GOTO 190
2330 IF PEEK (222) = 13 THEN VTAB 10 : HTAB 10 : PRINT "NOT
A TEXT FILE " : FOR I = 1 TO 1500 : NEXT : GOTO 190
2340 IF PEEK (222) = 53 THEN VTAB 10 : HTAB 10 : PRINT "ILLE
GAL QUANTITY " : FOR I = 1 TO 1500 : NEXT : GOTO 190
2350 PRINT "ERROR # " : PEEK (222) ; "AT LINE # " : PEEK (218) +
PEEK (219) * 256 : END

```

End of listing.

What you should know about the International Apple Core.

If you're like most Apple users, you don't realize the many benefits of an IAC membership. Or what it can do for you and your computer.

So what's an IAC?

International Apple Core™ is a non-profit organization of Apple users and user groups and has been serving Apple users since 1979. We are dedicated to providing education, information and support to users of Apple technology.

The International Apple Core is comprised of thousands of individual members and hundreds of user group members. Get together with your fellow members and share information on new applications, keep up on Apple events, receive specialized training, or learn the latest on new software and hardware products.

If you'd like to join a local users group we can help you find one. Want to start a users group in your area? IAC can help.

Support for your Apple and you.

Understand your computer better with such books as *Beneath Apple DOS*, *Beneath Apple PRO-DOS*, and *Universal File Conversion*, all discounted to members.

Interested in computer insurance to protect your hardware, software, and even your data? IAC can help you obtain coverage through "Data Security Insurance".

Discounts on hundreds of public domain software programs, as well as selected commercial software products.

Information, please.

IAC provides many sources of information. Your \$30 yearly membership fee brings you IAC's newsletter "IAC Express", discounts on our many products, access to IAC's BBSs and a 12-issue subscription to *Nibble* magazine devoted to Apple systems and compatibles. *Nibble* magazine features more than \$50 dollars worth of ready to run Apple programs in each issue. The programs focus on home, business, education and entertainment. *Nibble* also features new products, reviews, tips and techniques for learning more about your Apple and having fun doing it!

As a member, you may subscribe to our Disk of the Month (DOM); \$60 will bring you a one year subscription. The DOM is a disk of public domain software which is mailed directly to your home each month with themes such as utilities, education, games, or a potpourri of different programs.

A membership That pays you.

As a member of the IAC you nearly get paid with what you will save. By joining you will save almost 20% on our AppleWorks Mailing Program which is used to create automated form letters from your AppleWorks database and word processing files.

Discounts on books, public domain software, and even *IACcalc* spreadsheet for under \$40.00.

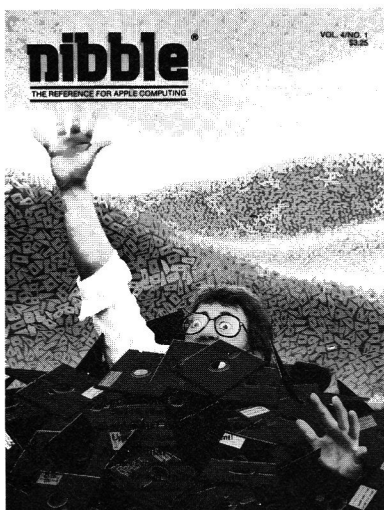

Circle 157 on Reader Service Card.

Apple, Apple II, Apple III and SOS are registered trademarks of Apple Computer, Inc.

International Apple Core is Licensed by Apple Computer, Inc. to use certain of the latter's trademarks.

IACcalc and 3Pak are trademarks of International Apple Core. CP/M is a registered trademark of Digital Research.

Nibble is a registered trademark of microSPARC, Inc.

Get an education.

You'll receive many educational benefits from our software programs. You'll receive 20% off our 3PaK™ series of theme packaged programs which includes Educational, Financial, Games and the popular Logo. We have an Applesoft Tutorial and Education disk which is great for children.

Educational books are available to members at discounts of up to 20% off the cover price, with such titles as *Understanding the Apple //*, *Understanding the Apple //e*, *Bag of Tricks* and more.

Invite your friends and save.

IAC offers user groups a special package. For \$90 your group receives a full year IAC membership, IAC Express, all members of your group will have access to our BBSs, a subscription to *Nibble* for your group's library, and also a subscription to our DOM (disk of the month). Your group will be listed among the other hundreds of IAC user groups so that other local IAC members and Apple users will be able to locate you easily.

Individually or as a group you can't lose. So fill out the membership coupon below now, and don't forget to ask for our product catalog.

Membership Application

Individual Memberships

\$30 USA Individual
\$40 Canada
\$75 Elsewhere

Name _____
Address _____
City _____
ST/Zip _____ Country _____
Phone # _____

All memberships include a 12-month subscription to *Nibble* magazine. Please allow 6-8 weeks for delivery of your first *Nibble*.



**INTERNATIONAL
APPLE CORE™**

International Apple Core
Membership Dept. 1-04
2278 Trade Zone Blvd.
San Jose, CA 95131 (OR phone) (408)-262-9419

User Group Memberships

\$90 USA Group package
\$155 User Group package elsewhere
____ I'm already a *Nibble* subscriber,
Please extend my existing subscription.

Payment enclosed (US funds drawn on a US bank only)

____ VISA ____ Mastercard

Exp. Date _____

Card # _____

Signature _____

The Sequel to an Exciting Software Premiere...

hotCider VOLUME II

More Of The Very Best Ready-to-run Apple II* Programs From inCider

Available now... a second incredible collection of *inCider* magazine's best programs. **hotCider Vol. II!**

Get a dozen ready-to-run programs for the Apple II on a high-quality, menu driven floppy disk. Programs for business, home management, education, entertainment, and graphics! No tedious typing or debugging to worry about! And it comes complete with its own documentation booklet.

What A Menu!

Just like the exciting Vol. I, *hotCider Vol. II* is loaded with all-time *inCider* favorites:

"Should I Trade?"—Tells you the Real cost of buying a new car.

"Low-Res to Hi-Res"—Shows you how to easily convert your lo-res pictures to hi-res.

"Modem Battleship"—Dial up a friend and use your modem to play this latest version of Battleship.

Plus, more utilities, games, and educational programs!

Vol. I— Still Available!

If you haven't ordered your *Volume I* yet, the premiere issue of *hotCider* is still available in limited quantities!

Enjoy such standouts as;

"VisiData"—A list handler that works like a spreadsheet.

"Poster Printer"—Say anything in a BIG way with your printer.

"Doing Windows"—Learn how to create Macintosh-style windows on your Apple II.

hotCider Vol. I also gives you three previously unpublished *bonus programs*, including "Cider Zap" (a full-fledged editing utility)!

Easy To Use, Easy To Order

There's no easier way to build a versatile software library than with *hotCider Vol. I and Vol. II*. To order your copies, return the coupon or attached card, or call **1-800-258-5473**. In NH, dial 1-924-9471.

YES! I want the very best ready-to-run programs from inCider.

Send me hotCider on disk for \$21.47**.

- hotCider Vol. II hotCider Vol. I
 Payment enclosed AE Visa MC

Card # _____ Exp. date _____

Signature _____

Name _____

Address _____

City _____ State _____ Zip _____

* Apple and the Apple logo are registered trademarks of Apple Computer, Inc.
 ** Prices include postage and handling. Foreign airmail please add \$1.50 per item.
 US funds drawn on US banks only. **5-86BI**

hotCider • 80 Pine Street • Peterborough, NH • 03458



inCider

inCider magazine is published monthly by CW Communications/Peterborough, Inc. Entire contents copyright 1986 CW Communications/Peterborough, Inc. No part of this publication may be reprinted, or reproduced by any means, without prior written permission from the publisher. All programs are published for personal use only. All rights reserved.

inCider is a member of the CW Communications/Inc. group, the world's largest publisher of computer-related information. The group publishes over 50 computer publications in more than 20 major countries. Nine million people read one or more of the group's publications each month. Members of the group include: ARGENTINA'S *Computerworld/Argentina*; ASIA'S *Asian Computerworld*; AUSTRALIA'S *Computerworld Australia*, *Australian PC World*, and *Macworld*; BRAZIL'S *DataNews* and *PC Mundo*; CHINA'S *China Computerworld* and *China Computerworld Monthly*; DENMARK'S *Computerworld/Danmark*, *PC World*, and *Run* (Commodore); FINLAND'S *Mikro*; FRANCE'S *Le Monde Informatique*, *Golden* (Apple), *OPC* (IBM), *Theoreme*, and *Distributive*; GERMANY'S *Computerwoche*, *Infowelt*, *PC Welt*, *Computer Business*, and *Run*; ITALY'S *Computerworld Italia* and *PC Magazine*; JAPAN'S *Computerworld Japan*; MEXICO'S *Computerworld/Mexico*; THE NETHERLANDS' *Computerworld Netherlands* and *PC World*; NORWAY'S *Computerworld Norge* and *PC Mikrodata*; SPAIN'S *Computerworld Espana*, *PC World*, and *Commodore World*; SWEDEN'S *ComputerSweden*, *Mikrodata*, and *Svenska PC World*; SWITZERLAND'S *Computerworld Schweiz*; THE UNITED KINGDOM'S *Computer News*, *PC Business World*, and *Computer Business*; VENEZUELA'S *Computerworld Venezuela*; THE U.S.'S *AmigaWorld*, *Computerworld*, *inCider*, *InfoWorld*, *MacWorld*, *Micro Marketworld*, *PC World*, *Run*, *80 Micro*, *Focus Publications*, and *On Communications*.

Problems with Advertisers: Send a description of the problem and your current address to *inCider*, Route 101 and Elm Street, Peterborough, NH 03458, attn. Rita Rivard, Customer Service Manager. If urgent, call (800) 441-4403.

Problems with Subscriptions: Send a description of the problem and your current and/or most recent address to: *inCider*, Subscription Department, P.O. Box 911, Farmingdale, NY 11737. Or call (800) 645-9559, (800) 732-9119 in New York, between 9 a.m. and 5 p.m. E.S.T., Monday through Friday. If you have a problem with payment, please have your mailing label and your cancelled check or credit card statement in front of you.

Change of Address: Send an old label or a copy of your old address and new address to: *inCider*, P.O. Box 911, Farmingdale, NY 11737. Please give eight weeks' advance notice.

Microfilm: This publication is available in microform from University Microfilms International. United States address: 300 North Zeeb Road, Dept. P.R., Ann Arbor, MI 48106. Foreign address: 18 Bedford Row, Dept. P.R., London, WC1R4EJ, England.

Dealers: Contact Raino Wirein, Direct and Newsstand Sales Manager, *inCider*, Route 101 and Elm Street, Peterborough, NH 03458. Call (800) 343-0728.

Back Issues: Send \$3.50, plus \$1.00 postage for each copy to *inCider*, Back Issues Dept., Route 101 and Elm Street, Peterborough, NH 03458. For ten or more copies postage is a blanket \$7.50. To order by telephone using VISA, MasterCard or American Express call (800) 258-5473 from outside New Hampshire, or 924-9471, ext. 136, within New Hampshire.

Submissions: We're always looking for first-class manuscripts at *inCider*. We'll consider publication of any material for the Apple. Guidelines for budding authors are available—just address an envelope to yourself and include it with your request. Mail manuscripts, queries, or requests for writers' guides to: *inCider* Editorial Offices, 80 Pine Street, Peterborough, NH 03458.

COMING ATTRACTIONS

- **Beginners' Luck:** Did you get a //c for Christmas? Find out what beginners can do with their new Apples.
- **Ten good reasons not to buy a computer and ten great reasons—some exciting products—to buy one**
- **Bulletin-board systems:** Profiles of their use in business and education
- **Hints/Techniques:** A tip for keyboard control and a program that converts binary to text files
- **Reviews:** Flipster, Equations, Blankenship BASIC, the Kache Board, and more

ATTENTION. . . Foreign Computer Stores. . . Magazine Dealers. . .

You have a large technical audience that speaks English and is in need of the kind of microcomputer information that CW/Peterborough provides.

Provide your audience with the magazine they need and make money at the same time. For details on selling **80 MICRO**, **inCider**, **RUN**, and **AmigaWorld** contact:

Sandra Joseph
World Wide Media
386 Park Ave., South
New York, N.Y. 10016
Phone (212) 686-1520
Telex-620430

This Publication is available in Microform.

University Microfilms International

Please send additional information
for _____

Name _____

Institution _____

Street _____

City _____

State _____ Zip _____

300 North Zeeb Road, Dept. P.R., Ann Arbor, Mi. 48106

MOVING? PROBLEM?

Get help with your subscription by
calling our new toll free number:

1-800-645-9559*

between 9 a.m. and 5 p.m. EST,
Monday-Friday.

If possible, please have your mailing
label in front of you as well as your
cancelled check or credit card state-
ment if you are having problems with
payment.

If moving, please give both your old
and new address.

*New York State residents call
1-800-732-9119.



5 1/4" DS/DD with hub ring and sleeve,
factory warranted, packaged in 50's.
Shipping Extra. Quantity 50, 85¢ each.

The same
low price
our volume
copying
customers pay!
75¢ each
Qty. 100

We sell 3 1/2" & 5 1/4" disks—all
types, major brands. Call toll free:

1-800-321-4668
in Colorado, 303-234-0871

VISA, MASTERCARD, OR COD ACCEPTED

ALF 1315-F Nelson St.
Denver, CO 80215

EDITORS' CHOICE

Homework Helpers: Tools for Learning

When your youngster gets bogged down in math problems and composition, two new programs from Spinnaker can answer your cry for help. A student can use **Homework Helpers** throughout several grades, and in a number of subjects.

Homework Helper: Math Word Problems is the first in what promises to be a series from Spinnaker. You remember word problems: "Kevin can run two meters farther than Jim each second. They live six kilometers apart. If they run toward each other, it takes them ten minutes to meet. How fast does each boy run?"

Word problems were the worst—impossible to understand. But word problems are also the best—maybe the only—link in high-school algebra to what theoretical mathematicians call reality. Word problems intimidate young people, and timid people turn away from math. And they grow up to not understand loans or household finance.

Teachers and parents agree, after hours with a student who "doesn't get it," that he or she usually needs to be prodded continually into putting the information from the problem—numbers, times, speeds, and ages—into a grid, then into an equation. "I can solve the equation," the youngster always says.

Homework Helper does what you or a tutor would do: asks kids the right questions, draws a box to organize the information, asks what the key words in the problem are.

Helping sounds easy. It isn't. It's a good job for your Apple, because the computer is endlessly repetitive, and infinitely patient. Homework Helper is less likely than you are to scream in dismay, "No! Put the number of dimes *first*," after 30 word problems.

Homework Helper is no panacea—your child has to be able to read, and know some basic arithmetic. But the program actually helps the student solve the problem without solving it *for* him or her.

"Homework Helper is a tool for learning," technical editor Paul Statt, a former math teacher, says. "It's a very workmanlike tool without frills, or bells and whistles or exploding balloons. It does a job people hate, and does it better than any person could. That's what I expect from a computer."

Managing editor and mother Dawn Matthews appreciates a "break from the homework battleground." Of course, *The A-Team* is another sort of truce, but Dawn likes Homework Helper because "it encourages logical thinking."

Homework Helper: Writing is a companion product that helps students put words on paper. It asks questions like "What are you trying to say?" and "To whom are you talking?" and walks kids through writing the same patient way Word Problems handles math.

Homework Helper: Math Word Problems and Homework Helper: Writing are priced at \$49.95 each, and are available now from Spinnaker Software, One Kendall Square, Cambridge, MA 02139, (617) 494-1200. ■

Editors' Choice singles out one product each month that the inCider editors feel is a significant addition to the Apple II family of products.

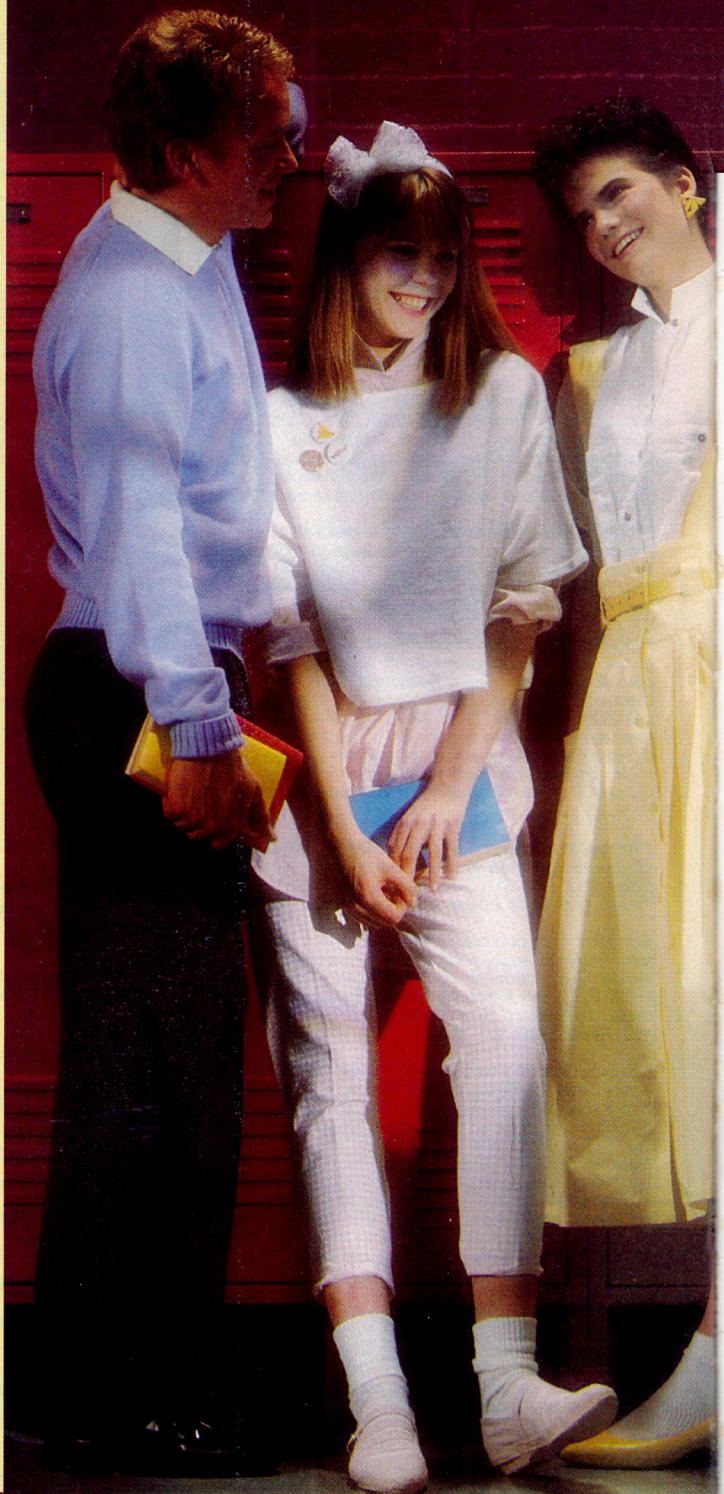

Let's compare ApplesTM to ApplesTM.



An Apple IIc



An Apple IIc with Z-RAM

The Apple IIc on the right works exactly the same as the Apple IIc on the left. Almost. The Apple on the right has a powerful memory expansion coprocessing card called Z-RAM. From Applied Engineering. Which means the Apple on the right can completely load AppleWorks into RAM—and then run it up to thirty times faster than the Apple on the left.

Z-RAM also acts as a solid-state disk drive. Which means the Apple on the right will load and store programs up to 30 times faster. And, our included RAM disk is compatible with Applesoft, PRO-DOS, DOS 3.3, PASCAL and CP/M.

Turbo Charged AppleWorks.

Even a 256K Z-RAM can completely load AppleWorks into RAM. With Z-RAM, the moment your fingers touch the keyboard AppleWorks responds. A 256K Z-RAM lets your IIc run AppleWorks up to 30 times faster, increases available desktop to 235K and maximum number of records from 1,350 to over 15,000, quadruples the number of lines allowed in the word processor, provides a print spooler, and auto-segments large files so they can be saved on two or more disks. A 512K Z-RAM boosts AppleWorks desktop to an incredible 425K.

Take a closer look.

There's more. Z-RAM has a built-in high speed Z-80B microprocessor that allows you to run CP/M programs. Which means you now have access to the single largest body of software in existence, including popular packages like WordStar, dBase II, Turbo PASCAL and Microsoft BASIC. A 16 bit option is also available.

And still more. Z-RAM is compatible with all IIc software and hardware, installs easily in just ten minutes with a screwdriver (slightly longer without), is available with 256K or 512K of additional memory (a 256K Z-RAM can be upgraded to 512K at

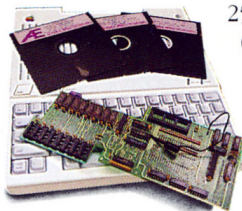

any time). Z-RAM is easily handled by the IIc power supply with our patent pending power saving design.

The only thing better than that would be a recommendation from Steve Wozniak.

"I recommend Applied Engineering products wholeheartedly!" (Of course, Steve's IIc has a Z-RAM installed.)

Steve Wozniak, the creator of Apple Computer



For fast response.

Z-RAM comes complete with simple instructions, RAM disk software, Z-80 operating system, CP/M manual. And a five year "hassle free" warranty. Make a good Apple great. With 256K Z-RAM "384K total" (\$329); with 512K "640K total" (\$389); 16 bit option may be added later (\$89).

If you want to run CP/M software, but don't need more memory, we suggest our Z-80c card. The Z-80c has no memory expansion ports and is priced at only \$159.

Call 214-241-6060 TO ORDER TODAY. 9 a.m. to 11 p.m. Seven days, or send check or money order to Applied Engineering. MasterCard, Visa and C.O.D. welcome. Texas residents add 5% sales tax. Add \$10.00 outside U.S.A.

AE Applied Engineering
P.O. Box 798, Carrollton, TX 75006
(214) 241-6060

Only the Hayes® Transet 1000® can get you out of this one.

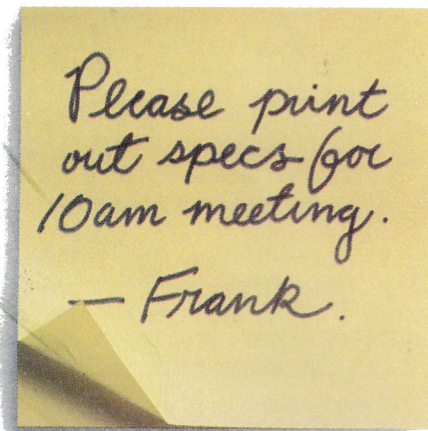
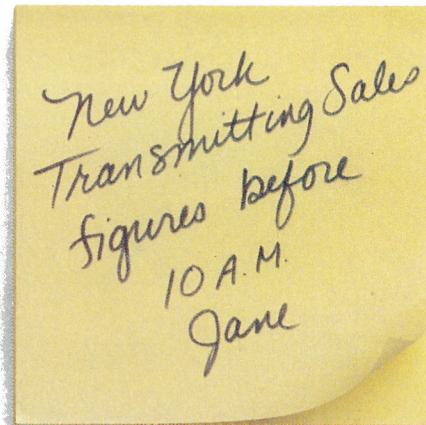
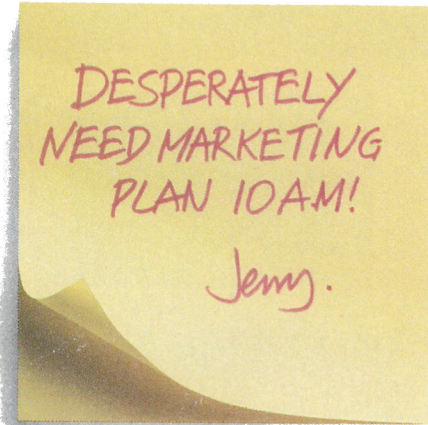

© 1986 Hayes Microcomputer Products, Inc.

Now your PC can do three things at once instead of making you wait while it does one thing at once.

We call it *triple tasking*®.

It means you can work with your PC while the Transet 1000 receives your electronic mail and runs your printer for you simultaneously.

Three jobs at once. No waiting.

When you're away from your desk, or at night while your PC is turned off, Transet 1000 serves as an electronic mailbox.

Because it has its own independent 128K or 512K memory.

To get the messages that come in through the night, you can call them up on your PC. Access them through a remote modem if you're away from the office.

Or even have them waiting for you in hard copy.

By now it's dawning on you

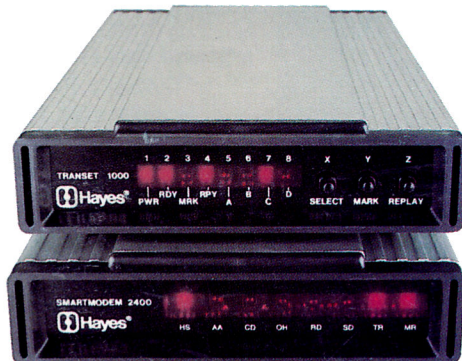

that Transet 1000 can make your PC about three times as productive as it is now. Which is no small statement.

You've also figured out it's more than just a print buffer. More than just a communications buffer. And probably costs a lot. Right?

Wrong!

It costs only \$399* for the 128K model which stores up to 90 pages. And only \$549* for the 512K version with up to 360 pages of storage.

For more information and specifications, contact your authorized Hayes dealer. Or Hayes directly at (404) 441-1617.

Hayes Microcomputer Products, Inc., P.O. Box 105203, Atlanta, Georgia 30348.

Hayes®

Say yes to the future with Hayes.

*Manufacturer's estimated retail price.

Circle 51 on Reader Service Card.