

incider

A CWC/I PUBLICATION

USA \$2.95 / Canada \$3.95
April 1986

Tax Time

HOW MUCH DO YOU OWE?

Seven Tax Programs
to Save Money;
Make Filing Easier

DO DRILLS MAKE DRONES?

Thought Provoking Software
For the Classroom

THE MAGIC MOUSE

A New World for the II

APPLEWORKS:

Price Quotes Made Easy

REVIEWS:

-  Instant Pascal
-  Personal Financial Planner



"Pinpoint makes AppleWorks™ better than my Macintosh."

It gives me the flexibility of Mac-like desk accessories and the ability to add the features AppleWorks 'forgot.'"

*Michael Fischer, Columnist, Bay Area Computer Currents.
Author, 65816 Assembly Language Programming, 1986, Osborne McGraw-Hill.*

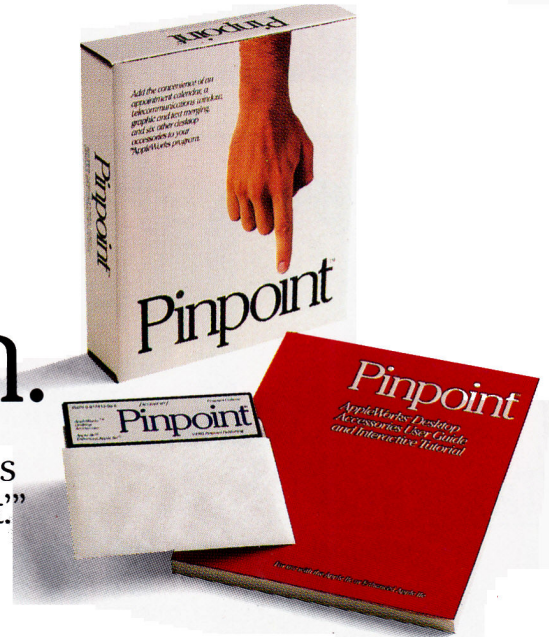

PINPOINT™ DESKTOP ACCESSORIES Now you can address an envelope, call a friend, schedule an appointment, search online databases, send or receive electronic mail, merge pictures and text, jot down notes, calculate numbers, or pop-up an electronic typewriter. Without missing a beat. Or a byte. These handy desktop timesavers "pop-up" via windows from inside AppleWorks and other selected ProDOS™ programs. Eight powerful applications in one high-performance package. **\$69.**

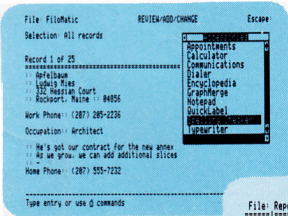

Up to 16 Accessories. Add new accessories anytime. Like the SPELLING CHECKER, or the powerful INFORMATION ENGINE™ for desktop reference publishing on floppy disks or CD-ROM — encyclopedias, user guides, directories and courseware.

Find misspellings, suggest correct, edit, and reformat. Instantly check any word, paragraph or document, spreadsheet or database entry. Even edit your work on the fly!

SPELLING CHECKER Pop it up and quickly check individual words, paragraphs, or entire documents without leaving AppleWorks behind. Poof! Check for misspellings from a 55,000 word dictionary and an unlimited personal dictionary. It

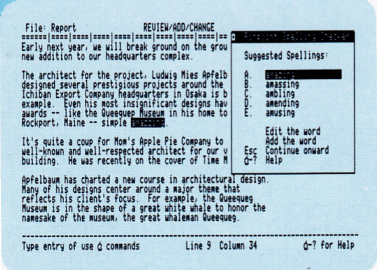

suggests up to 10 alternative spellings, corrects words in place, and reformats as it corrects. You can even edit words it finds yourself. Absolutely the quickest most convenient way to produce letter-perfect documents. **\$69.**

YES, I WANT TO GIVE MY APPLE II THE WORKS.

Order both Pinpoint and Spelling Checker NOW! We'll supercharge your RAM card with the \$29 RAM Enhancement Kit FREE! **\$125**

- \$69 PINPOINT Desktop Accessories.
- \$69 Spelling Checker. Requires Pinpoint.

Pinpoint's software requires an Enhanced Apple IIe with 128K, or Apple IIc. We recommend two floppy disk drives, a UniDisk 3.5, hard disk, or RAM drive.

Name _____
 Address _____
 City _____
 State/Zip _____
 Telephone _____
 Payment: VISA MC Check
 Credit Card # _____
 Credit Card Expir. Date _____
 Add \$3.00 shipping. CA residents add 6.5% sales tax.

Box 13323, Oakland, CA 94661, (415) 654-3050

Pinpoint

National 800-227-6703
 California 800-632-7979

Break the 128K barrier. For top performance use Pinpoint Accessories with your RAM card from Apple, Applied Engineering, AST or Checkmate. The RAM Enhancement Kit lets you do even more.

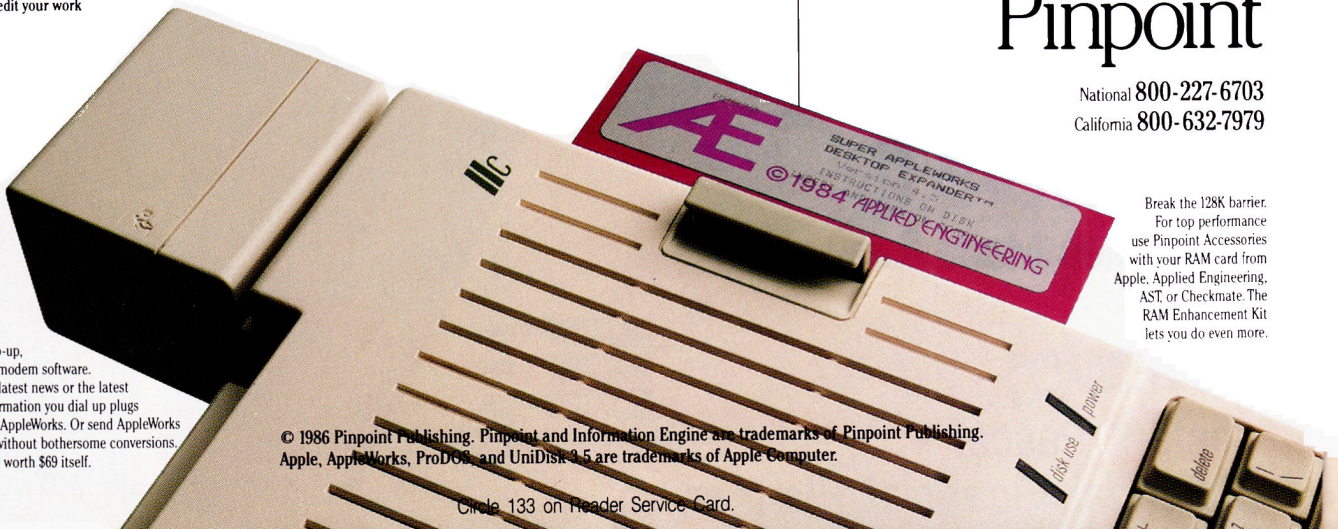

Includes pop-up, auto log-on modem software. Capture the latest news or the latest recipes; information you dial up plugs directly into AppleWorks. Or send AppleWorks documents without bothersome conversions. Convenience worth \$69 itself.

© 1986 Pinpoint Publishing. Pinpoint and Information Engine are trademarks of Pinpoint Publishing. Apple, AppleWorks, ProDOS, and UniDisk 3.5 are trademarks of Apple Computer.



Another Great Simulation from Sid Meier – Author of F-15 Strike Eagle

Now he takes you from the cold, thin air and limitless space of F-15 Strike Eagle down into the dark depths of the Pacific Ocean inside an American World War II submarine for a realistic, action-filled simulation —

SILENT SERVICE

Enhanced With
Mockingboard
Great Sounds
and Actions Together!
In the (A,B,C)

Thrill to the initial sighting of the enemy's strike force in your periscope as their ships come into your range. But watch out — the enemy's escorts have just sighted you. You're the **hunter** — but suddenly — you've become the **hunted!**

As Commander, you must sink their ships and keep your submarine from being destroyed — if you can. Will you select a quiet patrol sector in the Marianas Islands or choose the dangerous waters off the coast of Japan? Is a submerged daylight periscope attack best or do you charge in on the surface at night using only radar bearings to guide you? Do you fire a spread of your precious torpedoes or can you close the range and pick off the enemy with a single torpedo shot? These decisions and many more are yours to make as you take your place among the elite ranks of the **SILENT SERVICE!**

It's **exciting** — and it's **fun**. It's another great Micro Prose simulation — and it's called **SILENT SERVICE**. Look for it now on your dealer's shelves.

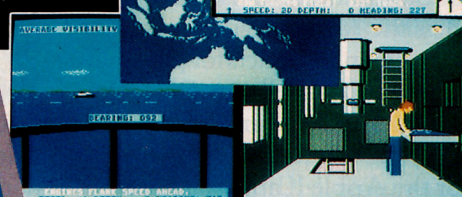

FIVE AUTHENTIC BATTLE STATION SCREENS

Silent Service is available for Commodore 64/128, Apple II Family, Atari XL/XE, IBM PC/PC Jr. computers for a suggested retail of only \$34.95. Available soon for Macintosh for a suggested retail of only \$39.95. Call or write for more information or MC/VISA orders.

COMMODORE, APPLE, ATARI, IBM, and MACINTOSH, are registered trademarks of Commodore Business Inc., Apple Computer Inc., Atari Inc., and International Business Machines Inc., respectively.

Photo courtesy Baltimore Maritime Museum
Circle 206 on Reader Service Card.

Try These Other Real Life Simulations

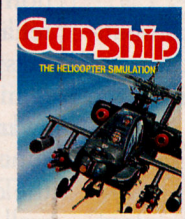

Daring Attack Helicopter Action in the AH-64 Apache!



Thrilling Decathlon of aerobic events in your own personal jet!!

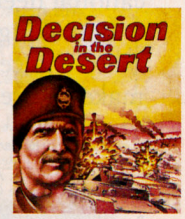

You are in command — North Africa 1940-1942

MICRO PROSE

SIMULATION • SOFTWARE

120 LAKEFRONT DRIVE • HUNT VALLEY, MD 21030 • (301) 667-1151



Why The Biggest Names In Sof AST's SprintDisk™ Memory

AST and leading software manufacturers are working together to break new ground, establish new standards and provide new solutions that enhance the power of your Apple II for your serious business and educational needs.

In making their hardware compatibility choices — choices that can make or break their companies — the

*The most current versions
SprintDisk, SprintCache trademarks and SixPakPlus registered trademark of AST Research, Inc. Apple registered trademark and Apple II, Macintosh, AppleWriter II, AppleWorks and ProDOS trademarks of Apple Computer, Inc. BusinessWorks is a trademark of Manzanita Software Systems. MouseWrite is a trademark of Roger Wagner Publishing, Inc. Dollars and Sense is a trademark of Monogram. BPI and BPI Systems are trademarks of BPI Systems, Inc. Sensible Speller is a trademark of Sensible Software, Inc. Mouse Calc and Mouse Desk are trademarks of Version Soft. SuperCalc 'a is a registered trademark of Sorcim/IUS Micro Software, A Division of Computer Associates International, Inc. PFS: Write, PFS: Plan, PFS: Report, PFS: File and PFS: Graph are registered trademarks of Software Publishing Corporation. Catalyst is a trademark of Quark Incorporated. ReportWorks registered trademark of Megahouse Corporation. Pinpoint is a trademark of Pinpoint Publishing and Virtual Combinatics, Inc. Managing Your Money registered trademark of Micro Education Corporation of America.
Copyright ©1986 AST Research, Inc. All rights reserved.

software leaders look to AST, the hardware leader with the proven track record. So should you.

AST is the world's leading supplier of enhancement products for personal computers with a well-earned reputation for outstanding quality and reliability. We offer a full-line of products for the Apple II and Macintosh™ families. And you've heard of our award-winning SixPakPlus® multi-function card for the IBM PC — the defacto industry standard with well over 500,000 shipped.

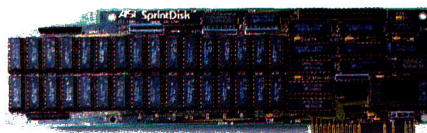

**Introducing SprintDisk:
Up To 2 MB Of Memory
Expansion And All The
Software Compatibility,
With None Of The
Modifications.**

The new generation memory card is here, now you can break the 64K barrier with all the software compatibility you need. Designed for use as a rapid-access, mass-storage device, SprintDisk provides up to 2 Megabytes of desktop workspace for your spreadsheets, word processing documents and databases.

Good-bye Software Patches.
With SprintDisk you can take advantage of expanded memory while saying "good-bye" to the hassles of modi-



Software Are 100% Compatible With Expansion For The Apple II.™

fications. All your favorite applications software* (those illustrated above and more) are completely, automatically and immediately compatible. Of course, SprintDisk is ProDOS,™ DOS 3.3 and Pascal 1.3 compatible.

The Speed of AST's SprintCache™ Buffer. We include exclusive utility software – we call it SprintCache – so if you are using multiple storage devices, you can also use SprintDisk as a caching buffer. It allows you to cache up to fourteen floppy, hard-disk or tape drives for higher performance and greater productivity.

Hardware Facts. SprintDisk is compatible with the Apple II Memory



Expansion board. It's fully socketed and user-upgradeable with 256 Kb chips. And it comes with its own RAM diagnostic software.

The Quality, Service and Support of an Industry Leader.

AST's worldwide reputation is built on quality. SprintDisk features the highest-quality four-layer construction and undergoes extensive testing and comprehensive burn-in procedures for the ultimate in reliability – AST has the lowest product failure rate in the industry. And don't forget our two-year warranty, world-renowned service and customer support.

For more information call (714) 476-3866 or circle the reader service below.

FEATURES

SprintDisk

- Up to 2 MB Total Memory
 - 256 Kb to 1.0 MB on mainboard
 - Up to 1.0 MB additional memory on piggyback card
- Apple II Memory Expansion board compatible
- SprintCache for fast, user-transparent disk/tape caching
- ProDOS, DOS 3.3 and Pascal 1.3 compatible
- No application software modifications necessary
- Fits any I/O slot except #3 in II, II+ or IIe
- Fully socketed and user-upgradeable

AST
RESEARCH INC.



A computer store's service at mail-order prices.

Because we're both.

Our commitment to service is why so many private individuals, schools and Fortune 1000 companies choose Micro City. If in the Chicago area, please visit our retail store at 24W500 Maple Ave., Naperville, IL 60540.



| DISKETTES | |
|---|--------|
| GENERIC | |
| Top Quality DS DD, 100% Certified, With Sleeve & Hub Ring, Each | .95¢ |
| VERBATIM | |
| SS DD Box of 10 | 17.00 |
| Disk Drive Head Cleaning Kit | 8.95 |
| Cleaning Disquettes—10 | 12.00 |
| 3 1/2" SS DD Box of 10 | 26.95 |
| DISK DRIVES | |
| MITSUBA | |
| Super 5 Direct Slim Drive, II+, //e (Year Warranty) | 145.00 |
| Super 5 Direct Slim Drive, //c (Year Warranty) | 149.00 |
| Super 5 Drive for Macintosh (Year Warranty) | 249.00 |
| Disk Drive Controller for 2 Drives, II+, //e | 45.00 |
| PACE | |
| AP-50 Full Height, Shugart Mechanism, II+, //e | 135.00 |

| GENERAL HARDWARE | |
|--|--------|
| ALL WITH 90 DAY WARRANTY, 14 DAY SATISFACTION GUARANTEE | |
| 16K Ram Card, II+ | 39.00 |
| 2.80 Card for II+, //e (Hardware Only) | 42.00 |
| Cooling Fan, 2 Outlets, Surge Protection, II+, //e | 29.00 |
| Replacement Keyboard, II+ | 69.00 |
| Computer Case, II+, Case with Built-in Numeric Keypad, II+ | 119.00 |
| RF Modulator | 19.00 |
| Power Strip with Surge Protection, 6 Outlets | 19.00 |

| MISCELLANEOUS HARDWARE | |
|---|--------|
| ADVANCED LOGIC SYSTEMS | |
| Z Engine (Z-80 with Software), II+, //e | 129.00 |
| AST | |
| Multifunction Board (2 Serial Ports, Clock/Cal) | 149.00 |
| CH PRODUCTS | |
| Mach II Joystick II+ | 38.00 |
| Mach II Joystick, //e | 38.00 |
| Mach III Joystick with Firebutton, II+ | 45.00 |
| Mach III Joystick with Firebutton, //e | 45.00 |
| Paddlestick, II+ | 45.00 |
| Paddlestick, //e | 45.00 |
| CHECKMATE TECHNOLOGY | |
| MultiRam //e 64K | 129.00 |
| MultiRam //e 128K | 149.00 |
| MultiRam //e 256K | 169.00 |
| MultiRam //e 512K | 199.00 |
| MultiRam //e 768K | 219.00 |
| MultiRam CX 256K | 239.00 |
| MultiRam CX 512K | 269.00 |
| MultiRam CX with 16 Bit Installed, 256K | 339.00 |
| MultiRam CX with 16 Bit Installed, 512K | 369.00 |
| KENSINGTON MICROWARE | |
| System Saver Fan, II+, //e | 65.00 |
| KOALA TECHNOLOGIES | |
| Koala Pad Plus with Software, //e, //c | 69.00 |

| Adapter to use Koala Pad with II+ (by Suncom) | 5.95 |
|--|--------|
| Gibson Light Pen | 149.00 |
| MacVision Digitizer for Mac | 179.00 |
| MacKAT for Mac | 149.00 |
| MICROTEK | |
| Magnum 80 me, 80 Col., 64K //e | 99.00 |
| Dumpling GX Graphics Printer Interface, II+, //e | 79.00 |
| MITSUBA | |
| 80 Col., 64K //e | 89.00 |
| MOUSE SYSTEMS | |
| A+ Mouse for //c, Mac (Optical Mouse) | 89.00 |
| N-2 Parallel A-B Switchbox | 59.00 |
| ORANGE MICRO | |
| Grappler + Graphics Printer Interface, II+, //e | 89.00 |
| Buffered Grappler +, 16K | 149.00 |
| Grappler C for //c | 99.00 |

| PRACTICAL PERIPHERALS—ALL WITH 5 YEAR WARRANTY | |
|---|--------|
| GraphiCard, Graphics Printer Interface, II+, //e | 79.00 |
| PrinterFace Printer Interface, II+, //e For Modem or Printer | 59.00 |
| II+, //e | 109.00 |
| Switchport //c, Serial to Parallel Converter | 89.00 |
| Microbuffer II+ Printer Interface Cards, II+, //e—includes both serial and parallel cables. Provides excellent buffer capability. | |
| 16K | 135.00 |
| 32K | 145.00 |
| 64K | 165.00 |
| Pro Clock, II+, //e | 109.00 |
| Microbuffer In-Line External Buffer 32K (Specify Parallel or Serial) | 189.00 |
| 64K (Specify Parallel or Serial) | 219.00 |
| 128K (Specify Parallel or Serial) | 259.00 |
| 256K (Specify Parallel or Serial) | 289.00 |
| Microbuffer/Epson (Buffer Mounts Inside Epson Printers) | |
| 16K Parallel | 115.00 |
| 32K Parallel | 135.00 |
| 64K Parallel | 175.00 |
| 8K Serial | 115.00 |
| 16K Serial | 125.00 |
| 32K Serial | 145.00 |
| QUADRAM | |
| eRam 80, 80 Col., 64K, //e | 109.00 |
| MultiCore w/No Memory, II+, //e | 179.00 |
| MultiCore w/256K | 299.00 |
| Ext. Multifunction Card for II+, //e | 189.00 |
| Pro Dos Clock/Cal, II+, //e | 75.00 |
| SUNCOM | |
| //e, II+ Joystick Adapter | 5.95 |
| SWEET MICRO | |
| Mockingboard A Music Synthesizer | 89.00 |

| Mockingboard B Speech Upgrade | 79.00 |
|--|--------|
| Mockingboard C Music + Speech | 139.00 |
| Mockingboard D for //c | 149.00 |
| TITAN | |
| 64K Ram Card, II+, //e | 159.00 |
| 128K Ram Card, II+, //e | 199.00 |
| Accelerator //e, II+, //e | 219.00 |
| VIDEO 7 | |
| Color Enhancer //e (RGB Adapter) | 132.00 |
| Color Enhancer //c (RGB Adapter) | 99.00 |
| Amdek AC-1100 Cable (Connects Video 7 Color Enhancer //e or //c to IBM Compatible RGB Monitor) | 15.95 |
| Slot 7 RGB Adapter for II+ | 119.00 |

| MODEMS | |
|--|--------|
| HAYES | |
| Smartmodem 300 (External Modem) | 145.00 |
| Smartmodem 1200 (External Modem) | 385.00 |
| Smartmodem 2400 (External Modem) | 619.00 |
| Micromodem //e with Software | 145.00 |
| Smartmodem 300 with Software, //c | 165.00 |
| NOVATION | |
| Apple CAT II with Software, II+, //e (300 Baud) | 187.00 |
| 212 Apple CAT Upgrade | 217.00 |
| 212 Apple Cat System (1200 Baud) | 349.00 |
| Expansion Module for Apple Cat | 29.95 |
| Smart Cat Plus 1200 Baud with Software, Mac | 299.00 |
| 2400 Professional Modem with Software, Mac | 519.00 |
| J-CAT | 89.00 |
| PROMETHEUS | |
| Promodem 1200 External | 289.00 |
| Promodem 1200A with Software, II+, //e | 259.00 |
| Transportable Modem //c with Software (300 Baud) | 139.00 |

| MONITORS | |
|---------------------------------------|--------|
| C-ITOH | |
| CM-1000 RGB & Composite, Green Switch | 359.00 |
| Cable for Apple II+, //e | 27.00 |
| ZENITH | |
| ZVM-1220 Amber | 109.00 |
| ZVM-1230 Green | 109.00 |

| PRINTERS | |
|------------------------|--------|
| EPSON | |
| LX-80 | 229.00 |
| Tractor for LX-80 | 29.95 |
| LX-90 with PIC for //c | 289.00 |
| LQ-800 | 595.00 |
| LQ-1000 | 729.00 |
| FX-85 | 359.00 |
| FX-286 | 539.00 |
| JX-80 Color Printer | 329.00 |
| DX-10 Daisy Wheel | 239.00 |

Publisher Terri Hamilton
Editor in Chief Deborah de Peyster
Managing Editor Dawn F. Matthews
Senior Editor Eileen T. Terrill
Review/New Products Editor Paul Staff
Copy Editor Robin Florence
Assistant Editor Lufe Low
Proofreader Peter Bjornsen
West Coast Editor Wendy Lea McKibbin (415) 328-3470
Field Editor Babs Cringely

Advertising

Sales Manager/Northeast Paul Boule (800) 441-4403 (603) 924-7138
Sales Representative Fiona Davies (800) 441-4403
Southeast and Central Sales Representative Donna Pomponi 1060 Marsh Road Menlo Park, CA 94025 (415) 328-3470 (800) 344-4636 in CA
Sales Manager/Northwest Sanford L. Fish 1060 Marsh Road Menlo Park, CA 94025 (415) 328-3470 (800) 344-4636 in CA
Advertising Coordinator Kim Labbe (800) 441-4403
Marketing Services Manager Michael Duran

Design

Art Director Donna Wohlfarth
Production Supervisor Phyllis Pittet
Ad/Graphics Production Rosemary Gibson

Graphic Services

Graphic Services Manager Dennis Christensen
Manufacturing Manager Susan Gross
Typesetting Supervisor Linda P. Canale
Typesetter Nancy Salwen

CW Communications/Peterborough

President/CEO James S. Povec
Vice President/Finance Roger Murphy
Assistant General Manager Matt Smith
V.P. of Planning and Circulation William P. Howard
Circulation Manager Frank S. Smith
Direct & Newsstand Sales Manager Raino Wirein (800) 343-0728
Director of Credit, Sales, and Collection William M. Boyer
Executive Creative Director Christine Destrempe
Founder Wayne Green

inCider's BBS (bulletin-board system)
 On line 24 hours: (603) 924-9801

inCider (ISSN #0740-0101) is published monthly by CW Communications/Peterborough, Inc., 80 Pine Street, Peterborough, NH 03458. Phone: (603) 924-9471. Second-class postage paid at Peterborough, NH, and additional mailing offices. (Canadian second class mail registration number 9590.) Subscription rates in U.S. are \$24.97 for one year, \$38.00 for two years and \$53.00 for three years. In Canada and Mexico, \$27.97—one year only, U.S. funds drawn on a U.S. bank. Nationally distributed by International Circulation Distributors. Foreign subscriptions (surface mail), \$44.97—one year only, U.S. funds drawn on a U.S. bank. Foreign subscriptions (air mail), please inquire. **Postmaster:** Send address changes to inCider, Subscription Services, P.O. Box 911, Farmingdale, NY 11737. (Send Canadian changes of address to: inCider, P.O. Box 1051, Fort Erie, Ontario L2A 5N8.)

1-800-548-8244 (ORDERS ONLY)

312-355-9726

(INQUIRIES, ILLINOIS ORDERS,

CUSTOMER SERVICE & ORDER STATUS)

HOURS: MON.—FRI. 9:30-5:30, SATURDAY 10-4

TERMS: Check, Money Order, VISA, MasterCard or American Express. Please add 2% for credit card purchase. Personal checks allow 2 weeks to clear. Illinois residents add 6.25% sales tax. Prices subject to change. **SHIPPING/HANDLING:** Within Continental U.S. add \$2.50 per shipping carton. For APO, FPO, Alaska, Hawaii & Foreign add 5% (min. \$5.00). Please call for freight charges on large P.O.'s. Orders totaling \$25 or less add \$3.00 handling charge. **RETURNS:** An RMA Number must be obtained before any merchandise is returned. Defective goods returned to Micro City will be repaired or replaced at the discretion of the manufacturer. We can not guarantee machine compatibility. Non-defective merchandise returned will be charged a 10% restocking fee, with the exception of generic products. All returns must be complete units in original packaging.

PURCHASE ORDERS WELCOME FROM SCHOOLS AND WELL-RATED COMPANIES
DEALER INQUIRIES INVITED



A Division of Pace Systems, Inc.
 24W500 Maple Ave., Naperville, IL 60540

Photo & Illustration Credits: Cover, pages 44, 45, 47, 67, Eric S. Fordham, Professional Photographic Services Inc.; page 112, Frank Cordelle; pages 56, 57, 67, Chris Demarest; page 52, Carl Wesley; pages 94, 97, KAHANA/SHOOTING STAR.

ON THE COVER

44 Tax Time Can Mean Returns

by Martin A. Blumenthal
Reviews of seven tax-software packages, including one that works with AppleWorks and one that uses Multiplan files

50 Do You Know Where Your Money Is?

by Deborah de Peyster
Tips on buying financial-planning software from Manzanita CEO Jack Moore

ARTICLES

52 Do Drills Make Drones?

by Wendy Lea McKibbin
A look at the shift in schools toward using software that teaches critical-thinking skills

56 The Magic of the Visual Interface

by Cynthia E. Field
inCider looks at the new Mac-like software for the Apple II

67 The Taming of the Screen

by Bill O'Brien
How to update your Applesoft programs with Mac-like screen options



TUTORIALS

AppleWorks in Action 76
Preparing a Price Quote with an AppleWorks Spreadsheet
by Ruth K. Witkin

Right of Assembly 87
Branching Out
by Roger Wagner

Note: Applesoft Adviser, by Dan Bishop, will return in May with Enhancing Your Applesoft Bar Builder.

Downloaded from www.Apple2Online.com

DEPARTMENTS

inCider's View 6
Apple Sees the Light
by Deborah de Peyster

Letters 10

News Line 16
Mindscape's Latest; A Fair Shake for Women and Minorities; Trade In and Upgrade; Actions Speak Louder than Words; A Strategic Alliance?; Calendar

Apple Clinic 21
Patch Central; Scribe Information; Apple //c Modem Problems; Blooming Monitor; Another Clobbered Disk; Apple //c Keypad; 256K RAM Chips
by Jim Sather

Reviews 30
Instant Pascal; Kid Pro Quo; Your Personal Financial Planner; Transet 1000; LiveWire

Extract 93
A summary of inCider reviews and product ratings from the past four months

Game Room 94
Perry Mason; Star Trek: The Kobayashi Alternative; Temple of Apsai Trilogy
by Brian J. Murphy

Status Report 100
Interfaces
by Paul Statt

New Products 102
Hints/Techniques 106
Super Startup

Coming Attractions 108

Reader Services 108

Editors' Choice 112
ImageWriter II: The Poor Man's Laser Printer

INCIDER'S VIEW

Apple Sees the Light



“Apple is once again returning to its Apple II roots with a fervor perhaps never seen before. It has been reborn.”

by Deborah de Peyster

Let's talk about being born again. It happens in religion—people leave their faith, see the error of their ways, and return to their faith with renewed vigor. But we've just discovered that it happens in business, too. Actually, it happened to Apple Computer Inc., and we're glad.

During the past two years Apple lost faith in the power of the Apple II. While there was always a hard-core group of people at the company who believed in the Apple II (sort of like priests shouting their messages to the straying masses), no one listened. Under the dominance of Steve Jobs, who loved the Macintosh, the Apple II people became excommunicants. It seemed that the only thing anyone at Apple wanted to talk about was the Macintosh.

New Apple II development suffered—in fact, new products were cancelled; Steve Wozniak, the key Apple II engineer and evangelist, left the group; and one might say a general sense of **Apple II despair** was felt by all.

But things have changed. Apple has seen the error of its ways. The leader of the new Macintosh sect, Steve Jobs, was ousted. **Macintosh fervor has subsided**; the company has undergone a major reorganization; and Apple realized that the Apple II—particularly in education—is one of its greatest strengths. Apple is once again returning to its Apple II roots with a fervor perhaps never seen before. It has been reborn, and with new zeal is intent on *showing* its new commitment rather than just stating it.

And what this means to the masses Apple serves, particularly those in education, is a **better future**. A new policy to return old Apple and other brand-name computers for credit toward new Apple IIs, dedicated retailers who understand educators' needs, a promise of networks for the classroom before the end of the year, and new, more powerful computers are among Apple's programs this year that show its commitment to the II in education.

Another priority this year will be developing **programs for special education**. Apple president John Sculley says, “There

may be no other group in society for whom our computers promise more potential for independence and increased participation than the disabled community.” Apple plans to increase the awareness of, access to, and third-party development of disability-specific solutions in 1986.

And if Del Yocam, Apple's executive vice president of product operations, has his way, educators will be seeing some good **curriculum-based software** either from Apple or from independent companies.

Says Sculley, “Let us be clear in our commitment to education: We will always provide ways to enhance the Apple technology you have. We are serious about keeping your loyalty and partnership. . . . Education is our foundation. Our commitment to education will remain as solid as it is today.”

Interestingly, what often prompts a **rebirth** of such large proportions is an all-too-close view of hell. In the case of Apple Computer, the same is true. Last year Apple caught a glimpse of its own type of hell—the possibility of failure. Its last several major product introductions—Apple Lisa, a revised Lisa called the Macintosh XL, and the Macintosh itself—were startling disappointments. In the case of the Lisa and the XL, they were failures. Apple also lives constantly in the shadow of IBM, and lives every day with the knowledge that IBM is gunning for the education market that Apple holds so dearly.

Couple the possibility of failure with the knowledge that IBM is lurking in the shadows to take advantage of its slightest weakness, and you have real fear—possibly a glance at what we'll call **business hell**. Apple has roughly 60 percent of the education market, and that figure reflects only about one computer per classroom. Apple's stated goal is a computer on every desk. So the potential for growth is tremendous and success is inevitable, *if* Apple keeps or improves on its market share.

Thus Apple took decisive action—it finally saw the light—and we think none too soon. We're looking forward to more signs of commitment from Apple toward the Apple II, and we welcome its newfound faith in the product. ■

RamWorks II™

Up to 5,000,000 bytes to feed the biggest appetites.



*Now expand your Apple IIe to an incredible
5 megabytes of usable RAM!*

First came RamWorks. The IIe expansion card that became the unquestioned industry standard. Now Applied Engineering has done it one better ... with RamWorks II — a card so advanced, so powerful, we challenge you to find *anything* it doesn't offer.

RamWorks II makes a single Apple go a miraculously long way. With all the additional memory you'll need to feed even the hungriest of programs. And with the included RamDrive™ software, even older programs can use RamWorks II memory.



"I wanted a memory card for my Apple that was fast, easy to use, and very compatible, so I bought RamWorks."

*Steve Wozniak
Inventor of Apple Computer*

Now AppleWorks works even better.

You can choose versions of RamWorks II ranging in power from 64K all the way up to a whopping 5 megabytes. Even a 256K RamWorks II gives you over 200K of additional usable AppleWorks desktop.

With a 256K or larger card, AppleWorks will automatically load itself into RamWorks II, dramatically increasing AppleWorks' speed and power by eliminating the time required to access disk drive 1. So you can switch from word processing to spreadsheet to database management at the speed of light.

Only RamWorks II eliminates AppleWorks' internal memory limits, increasing the maximum number of records available from 1,350 to over 15,000. Only RamWorks II increases the number of lines permitted in the word processing mode. And only RamWorks II (256K or larger) offers a built-in printer buffer, so you won't have to wait for your printer to stop before returning to AppleWorks. RamWorks II even expands the clipboard. And auto segments large files so they can be saved on two or more disks.

The most compatible, most expandable card available.

RamWorks II is compatible with more off-the-shelf software than any other RAM card, as well as *all* software written for Apple cards, and software written for most other RAM cards too! It's also compatible with all hardware add-ons like Profile and Sider hard disks.

As your needs grow, so does RamWorks II. It's designed to accommodate future advances in 16 and 32 bit microprocessors. A connector allows coprocessor cards to access up to 5 MEG of memory. RamWorks II is expandable to 1 MEG on the main card (more than most will ever need) ... but if you do ever need more, a low-profile (no slot 1 interference) memory expansion connector allows you to add 512K, 2 MEG or 4 MEG of extra memory without wasting another slot.

And now, in living color ...

For only \$129, you can add RGB color for unsurpassed, super high-resolution color graphics and sharp 80 column text. *Without* wasting another slot — because our RGB option plugs right into RamWorks II (or original RamWorks) without slot 1 interference, and attaches to any Apple compatible RGB monitor (RGB option not necessary with a composite monitor). Order it now — or add it later.

Even corrects mistakes.

If you bought some other RAM card that's not being recognized by your programs, and you want RamWorks II, you're in for a nice surprise. Because all you have to do is plug the memory chips on your current card into the expansion sockets on RamWorks II to recapture most of your investment!

RamWorks II Prices:

with 64K (\$179), with 256K (\$219), with 512K (\$269), with 1 MEG (\$369), with 1.5 MEG (\$539), with 3 MEG (CALL), with 5 MEG (CALL), RGB option (\$129) (can be added later), 16 bit option (\$89) (can be added later).

It's time you let *your* Apple handle a lot of big appetites. Order RamWorks II today ... with 15-day money back guarantee *and* our "no hassle" five-year warranty. Call 9 a.m. to 11 p.m. 7 days, or send check or money order to Applied Engineering.

MasterCard, VISA and C.O.D. welcome. Texas residents add 5½% sales tax. Add \$10.00 outside U.S.A.

AE Applied Engineering
The Apple enhancement experts.

P. O. Box 798, Carrollton, TX 75006

(214) 241-6060

Introducing the World's

An Apple //e with the Checkmate Technology MultiRam™ provide 6 Megabytes of RAM. No other card even comes

Battery backup protects RAM data!

Built-in port allows up to 2 megabytes of battery-powered RAM to retain files and programs in memory for up to 10 years. Just load your programs (such as AppleWorks) once and you won't need the disk again for 10 years.

RGB Apple Video Output

MultiRam™ RGB provides full-color RGB Apple video output.

100% Apple compatible

This card doesn't even take up an expansion slot! It takes the place of the standard 80 column card in the auxiliary slot.

Built-in 65C816 CPU Port

The MultiRam™ RGB Card has a 65C816 CPU Port allowing the //e to run all existing Apple programs as well as incredibly powerful 16-bit software such as the Lotus 1-2-3 workalike, VIP Professional. This CPU can directly address up to 16 Megabytes of RAM.

AppleWorks power!

Imagine a desktop measured in Megabytes allowing huge databases and spreadsheets. Load AppleWorks completely into RAM for instant response.

ProDOS memory partitioning

The MultiRam™ RGB's memory can be partitioned to create directories and subdirectories, thereby eliminating the need for a second disk drive for many programs. The optional battery RAM can be used as extra memory or as a super fast disk drive that is reliable even if the power is interrupted. The battery backup allows you to keep the most commonly needed programs and files in memory, ready for instant use.

Memory Capacity

The MultiRam™ RGB Card comes with 64K of DRAM and can be expanded up to 1 megabyte. Optional Static RAM can add up to 2 megabytes. Optional MultiRam + Card can add an additional 3 megabytes. A fully expanded MultiRam RGB Card provides 6 megabytes of memory.

5-Year Warranty

The MultiRam™ RGB is made in the U.S.A. and backed by a 5-year warranty.

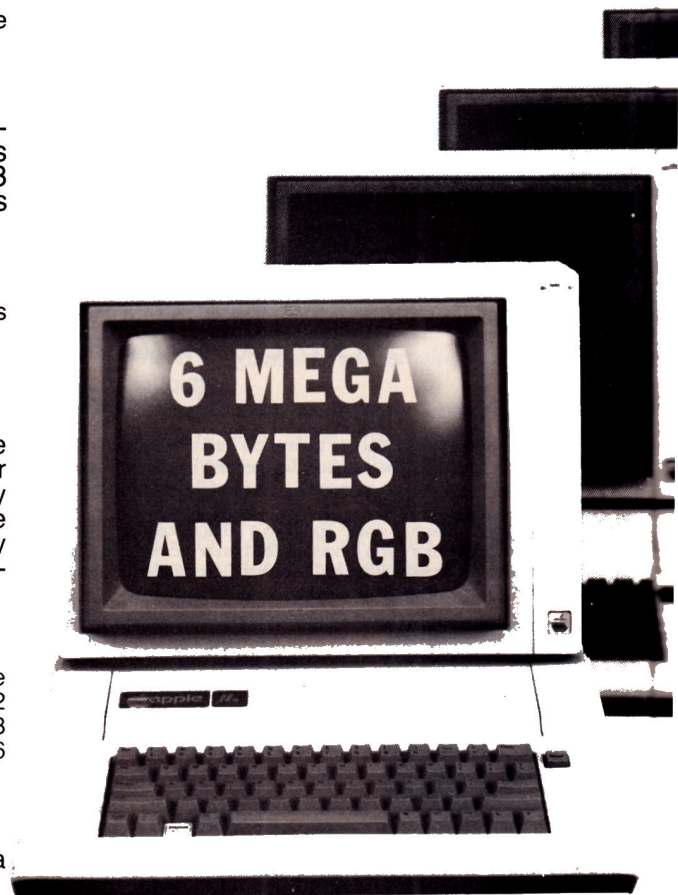

\$50 REBATE

Buy a Checkmate Technology MultiRam™ RGB Card before May 1, 1986 and send us your warranty card and a working RAM card (from any manufacturer) for the Apple //e with at least 8 256K chips installed. We will send, directly to you, a check for \$50.00

MultiRam is a trademark of Checkmate Technology, Inc. Lotus 1-2-3 is a trademark of Lotus Development Corp. App

Biggest & Fastest Apple

RGB Card can be expanded to
close to providing that kind of memory.



MultiRam™ RGB with 64K RAM

\$199.95

**Suggested
Retail Price**

SPECIAL LIMITED OFFER ON LOTUS 1-2-3 WORKALIKE Get VIP Professional and MultiRam™ EX Card For \$319.95

Unleash the tremendous 16-bit computing power of the 65C816 CPU with VIP Professional, a Lotus 1-2-3 workalike. VIP Professional gives the Apple //e the kind of power and speed essential in business, scientific and educational applications. For a limited time VIP Professional is available with a MultiRam™ EX card for just \$319.95 (suggested retail price). See your computer dealer today and move up to 16-bit computing. The MultiRam™ card allows you to run all existing Apple //e software as well as 16-bit programs such as VIP Professional.

Dealer Hotline 800-325-7347

Checkmate Technology, Inc.

509 South Rockford Drive • Tempe, Arizona 85281-3021
(602) 966-5802 U.S.A. MCI Telex: 6502788652
(800) 325-7347

IN CANADA CONTACT E.D.P. MARKETING (403) 482-3014



Apple //e and AppleWorks are trademarks of Apple Computer. VIP Professional is a trademark of VIP Technologies.

Dazzling Service

I must take exception to Robert Jackson's comments about Dazzle Draw from Broderbund Software (October 1985, Letters, p. 8). He complained about the incompatibility of the program with RGB monitors.

There are, in fact, two versions of Dazzle Draw. The first is designed for the majority of users, people who have monochrome or composite monitors, and it states that on the label on the front of the box. The other version is designed for RGB use and is available directly from Broderbund.

I purchased the program last June and ran into the same problems Mr. Jackson described. I also have the AppleColor card and the Apple Color 100 monitor. I wrote to Broderbund's customer-support people to advise them of my problem and received a response in less than five days. Following their instructions, I returned my original disk and requested the RGB version. The new disk arrived in less than a week. Service this fast is rare these days.

There are some compensations made in the RGB version in order to fully utilize the RGB capabilities, but not enough to really notice when using the program. I agree that Dazzle Draw is an outstanding program, and I'm more than pleased by the outstanding support Broderbund provides its customers.

CW2 Robert L. Arms
302 Hayes Circle
Fort Ord, CA 93941

Better for Education

Spinnaker Software's BetterWorking spreadsheet received a negative review in your September 1985 issue (p. 75), but much can be said on the positive side.

Business users with traditional spreadsheet involvement may well find the BetterWorking spreadsheet doesn't measure up to VisiCalc or others of that genre. But for educa-

tional applications, BetterWorking is a gem! Kids don't particularly care if the program is partially incompatible with VisiCalc files, or if you name a cell 3A or A3. And if they want word-processing power, they know enough to use a word processor.

The most exciting aspect of BetterWorking for classroom use is a built-in random-number generator. Teachers and students can model dice throwing or coin-flipping experiments, and many other simple or compound probability problems.

I've worked with many fifth- and sixth-graders using BetterWorking, and they love it!

John C. Russell
Natrona County School District, No. 1
970 North Glenn Road
Casper, WY 82601

Right On, Assembly

First of all, let me begin by saying that my once-a-month "fix" of *inCider* is truly not enough for an Apple fanatic like myself. I was frustrated with other Apple-oriented publications. They all seemed to assume that each reader has the benefit of ten years of computer experience.

It's maddening to start reading a piece and then have to play catch-up once you get beyond the introductory paragraph. Well, *inCider*, you've found a gem in Roger Wagner.

This gentleman has hit a responsive chord with his empathy and understanding for slower, but sincerely interested, beginners like myself. For example, after reading all the how-to's for program listings, tutorials, and so on, I found that only Roger Wagner was able to explain in one sentence the difference between machine language and assembly language.

I used to go crazy looking at assembly-language listings and wondering how I could make my computer generate them with proper mnemonics and format.

Mr. Wagner, *you* are a teacher! Your style is a breath of fresh air in

the inadequate, confusing, and overly technical climate of other computer-language tutorials. I'll be avidly looking forward to your future tutorials.

Stan Rivera

FORTH Is Here

In the December 1985 issue (Letters, p. 8), a reader inquired about FORTH for the Apple. FORTH is available in the public domain for the staggering price of only \$2.50 (plus an extra \$2.50 for the tutorial disk). Anyone interested should contact The Big Red Apple Club, 1105 South 13th, #103, Norfolk, NE 68701.

Bill Watson
430 Ridge Road
Wilmette, IL 60091

More User Groups

The Dubai Apple Tree Association is an Apple computer user group located in the Arabian Gulf. Although the club is based in Dubai, members come from all over the United Arab Emirates. The D.A.T.A. currently has 120 members and features Macintosh, CP/M, BASIC programming, and adventure-gaming special-interest groups.

David L. Rodrick
Dubai Petroleum Company
P.O. Box 2222
Dubai
United Arab Emirates

The Orange Apple Computer Club would like to thank you for your excellent series of articles on user groups in the September 1985 issue. We feel it's very important to become actively involved in your local user group to get the most out of your computer.

We have more than 1000 members from all over Southern California. The computer knowledge of our members varies from that of certified Apple developers to beginners who may not yet have purchased a computer system.

Our Apple SIGs are worth so much, we couldn't put a price on them.

Until April 30, we're waiving our \$49.95 registration fee to introduce you to the SIGs that could be priceless.

Join The Source today, and you'll get direct access to many other Apple® personal computer users through our new Apple and Macintosh™ Special Interest Groups at special SIG rates.*

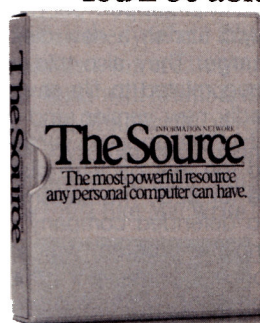

You'll be able to download and distribute high-quality public domain software. Find the best buys on the Apple personal computer market with our national bulletin boards.

Solve your toughest computing problems with help sessions from computer experts. And share your experiences with other Apple users from many different professions.

All of which will make you wonder how you ever got along without us.

And your membership will also include all the other useful services of The Source. Such as stock quotes and portfolio management, electronic mail, our online encyclopedia, and the Official Airline Guide.®

Plus there's a tutorial, *free-of-online charges*, that gives you unlimited time to master the system.

But you have to act now to take advantage of our free membership offer. So call **1-800-336-3366**** and

give our representative this claim number, 78ABV22. Or mail the coupon today.

Because joining The Source is smart. But joining The Source and our new Apple SIGs for free is ingenious.

Special Free Offer!

The Source INFORMATION NETWORK SM

The most powerful resource any personal computer can have.

Send no money. To sign up, just mail this coupon. Or call The Source toll-free at 1-800-336-3366 and give our representative this claim number 78ABV22.

- YES. I want to join The Source and take advantage of your free membership offer.
- Send my new SourcePak Manual (shown) for the reduced rate of \$12.95 plus postage and handling, charged to credit card below (retail price: \$19.95).

Please bill my future online charges to:

Visa Master Card American Express

Credit card # _____
(must be provided)

Expiration date _____

Name _____

Address _____

City _____ State _____ Zip _____

Signature _____

Mother's maiden name _____
(For verification)

PC type _____

Phone (day) _____ (evening) _____

Offer expires April 30, 1986.

MAIL TO: The Source, PO Box 1305, McLean, VA 22102

*Online rates as low as 10¢/minute. \$10 monthly minimum applies. **In Virginia, call 703-821-6666.

The Source is a service mark of Source Telecomputing Corp., a subsidiary of The Reader's Digest Association, Inc. Apple is a registered trademark of Apple Computers, Inc. Macintosh is a registered trademark of McIntosh Laboratory, Inc. © 1986 Source Telecomputing Corporation.

FREE? DISKETTES

SAVE MONEY! Apple II series users can use the diskette flip side, if another "write enable" notch is correctly made.

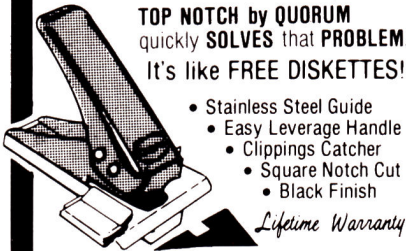

TOP NOTCH by QUORUM quickly **SOLVES** that **PROBLEM.** It's like **FREE DISKETTES!**

- Stainless Steel Guide
- Easy Leverage Handle
- Clippings Catcher
- Square Notch Cut
- Black Finish

Lifetime Warranty

Awarded the only A+ GRADE in a comparison test published by the **INTERNATIONAL APPLE CORE.** "The best I've found..."

IAC Reviewer

Certifix™

BE SAFE! The flipside of a single sided disk may have flaws. Any disk is **CERTIFIED 100% ERROR FREE** with CERTIFIX. IT "LOCKS OUT" BOTH DOS 3.3 & ProDOS DISK FLAWS.

- LOCKS OUT ProDOS & DOS 3.3 FLAWS
- SAVES STATUS REPORT ONTO DISK
- AUTOMATIC ProDOS/3.3 FORMATTING
- CREATE 40 trk DISKS & SYSTEM MASTER
- RECORDS TEST DATE onto disk
- NOT COPYPROTECTED

FREE CERTIFIX BONUS PROGRAMS

- Undelete DOS 3.3 files
- Test and Adjust Disk Drive Speed

Prevent Data Loss!

CERTIFY & FIX every disk with CERTIFIX!

Get THE BEST!

Ask our Customers:

U.S. National Bureau of Standard
TRW • IBM • Digital Research • AT&T
U.S. Naval Weapons Research Center
Alcoa • Rockwell International
General Electric Corporation

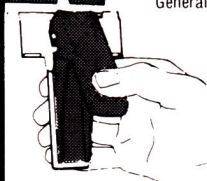

FREE!

64 Write Protect Tabs
32 Diskette Labels

If you get the
DISKETTE FLIP-KIT
which contains

TOP NOTCH and **CERTIFIX**

*100% Money Back
Satisfaction Guarantee!*

DISKETTE FLIP-KIT only \$29.95

TOP NOTCH is \$14.95

CERTIFIX is just \$24.95

Add \$2 s/h • CA add 6.5% tax

For your nearest dealer
or to order direct

CALL TOLL FREE

1-800-222-2824

In CA: 1-800-222-2812

From 8 am - 5 pm PST



Dealers Invited

QUORUM INTERNATIONAL, Unltd.
INDUSTRIAL STATION, P.O. BOX 2134 1C
OAKLAND, CA 94614

LETTERS

Unfortunately, you printed our old address. Our new address is Orange Apple Computer Club, 24522 Trabuco Road, Building 105, Suite 251, El Toro, CA 92630.

Thank you for continuing to publish an excellent magazine.

Linda Kay Butterworth
OACC Secretary

Fest Frustration

I've had a most aggravating experience, to the point that I feel it needs airing beyond the one it got at the last meeting of my user group, The Original Apple Corps.

I recently attended what was touted as an Applefest at the Long Beach Convention Center. Once inside, I found I had not come to an Applefest as such, but a Macfest instead. I was only able to find three or four Apple IIe's and about a dozen or less IIc's among those who had set up booths. All the remaining booths in that vast hall were occupied by Macs and only Macs.

There are only two possible conclusions I can draw from this experience. First, the Apple II family, which has been from year one, and in fact still is, the bread-and-butter of Apple Computer is now considered an embarrassment to that firm, and is to be frozen out by the firm's directing its resources nearly exclusively to the Mac, in hopes that Apple II owners will abandon their units and purchase Macs in their place.

The other is that maybe Apple had nothing to do with the "Macfest" (although I was given to understand it was sponsored by Apple), and the near total predominance of the Mac at the expense of all other Apple products was the work of local organizers. If this is the case, then where was the "truth in advertising" that would have saved me (and many others) the price of two admissions, a tank of gas, and, most importantly, an irreplaceable day of my time? All that would have been necessary was a simple statement in the promotional material such as "featuring Macintosh," or something similar. The word Applefest means *all* Apple products.

Please understand I have nothing against the Mac or those who use it. I do object to its being pushed to the exclusion of all other Apple products. When I brought this up at the user group meeting, I found that nearly everybody agreed with me. This sentiment seems to be representative of

Apple owners as a whole. I hope this reaches someone with the interest or authority to do something about the sort of situation allowed to take place at Long Beach.

Lee F. Bishop, Jr.
533 20th Street
Santa Monica, CA 90402

Cold War

Yesterday I purchased a copy of SpellWorks, newly arrived at a local dealer, for \$49.95. Although no back-up or mention thereof is included, it turns out to have a sophisticated copy scheme. When I attempted to make a routine back-up copy, one side of the original disk refused to boot. The problem with complicated copy-protection schemes like that is that they are fragile.

I called the Advanced Logic Systems customer-support people, who said they'd furnish a new disk at no extra charge. They also told me there was a bug related to file saving in my supposedly new version and they would ship the updated version. They informed me that back-up disks are available for \$25! The salesman I talked to defended company policy by saying the program was a "steal" at the price. I agree, but I think the end user is the victim. I suggest users avoid this software like the plague—or at least until someone discovers how to deprotect it and passes the information along. Obviously, I have no idea whether or not the program is a good one.

I have absolutely no sympathy for software publishers who moan and groan about piracy. It's interesting that we don't hear the same sanctimonious complaints from companies who sell unprotected software. Maybe they're too busy hauling their profits to the bank. Piracy, indeed—cold war is more like it.

Donald L. Schubert, Ph.D.
4926 La Cuenta Drive
Suite 103B
San Diego, CA 92124

inCider welcomes readers' comments regarding articles, letters, or other topics of interest. We reserve the right to edit letters for clarity, style, and space. Please address your correspondence to Letters, inCider, 80 Pine Street, Peterborough, NH 03458.

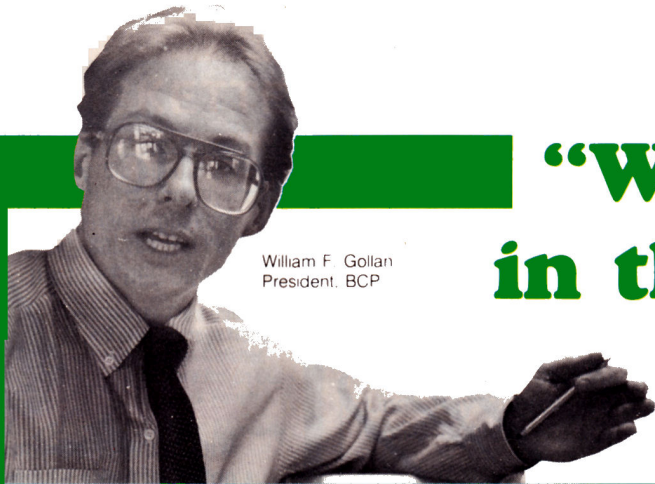

William F. Gollan
President, BCP

"We will match in this issue, our and shipping,

We'll support, service and warranty everything we sell and stand behind it 100%.

| MODEMS | | PRINTERS DOT MATRIX | | BUSINESS SOFTWARE | | UTILITIES & LANGUAGES | | |
|----------------------------|--------|--------------------------|--------|--------------------------------------|--------|-----------------------------|-------|-------|
| D.C. Hayes | | Citizen | | Sensible Software | | Mindscape | | |
| Smart 300 1lc w/sc & cable | 169.95 | MSP 120D | 209.95 | Bookends | 84.95 | Mister Pixel's | | |
| Micro Modem 11c w/sc | 144.95 | MSP 10 160 | 279.95 | Sensible Speller IV | 74.95 | Cartoon Kit | 23.95 | |
| Smart 1200 | 379.95 | MSP 15 160 | 379.95 | Graphics Dept. (New) | 74.95 | Paint Set | 23.95 | |
| Smart Modem 2400 | 589.95 | MSP 20 200 | 359.95 | Sensible Grammar | 69.95 | Color Me (Main) | 23.95 | |
| Transit w/128k | 289.95 | MSP 25 200 | 519.95 | | | Rainbow Britie | 9.95 | |
| Prometheus | | Epson America | | Sierra On Line | | Shirt Tales | | 9.95 |
| Pro 1200 | 299.95 | LX 80 | 249.95 | Homeword + (New) | 47.95 | Homeword Speller | 34.95 | |
| Pro 1200 A w/sc | 289.95 | LX 80 F/T | 279.95 | Home Word Filer | 47.95 | Hugga Bunch | 9.95 | |
| Pro 300C | 139.95 | FX 85 | 379.95 | Screenwriter Pro | 84.95 | Tink Tonk | 9.95 | |
| | | FX 286 | 539.95 | Software Publishing | | Penguin Software | | |
| PERIPHERALS | | LQ 800 | 579.95 | PFS:1st Success | 149.95 | Cat Graphics | 24.95 | |
| Amdek | | LQ 1000 | 699.95 | PFS:Write, Graph, Report & Plan (ea) | 74.95 | Complete Graphics System | 54.95 | |
| 300 G 12" Green | 119.95 | LQ 1500 | 919.95 | | | Graphics Magician | 42.95 | |
| 300 A 12" Amber | 124.95 | Okidata | | Sorcim/IUS | | Magic Paintbrush | | 24.95 |
| Color 300 Composite | 224.95 | ML 192 | 354.95 | Super IIIA | 109.95 | Pinpoint | | |
| Color 500 RGB | 259.95 | ML 192 Image. | 379.95 | Word Perfect | 84.95 | Pinpoint Toolkit | 44.95 | |
| Color 600 RGB | 389.95 | ML 193 | 489.95 | Spellchecker | 21.95 | Pinpoint Ram Exp. | 13.95 | |
| DVM III RGB Int. | 124.95 | ML 193 Image | 559.95 | United Software | | Roger Wagner | | |
| Apple* | | ML 84 | 649.95 | ASCii Express | 84.95 | Merlin Assembler | 40.95 | |
| II E's & II C's & Macs | CALL | Toshiba | | | | Merlin Pro | 64.95 | |
| Applied Engineering | | P-1340 | 409.95 | UTILITIES & LANGUAGES | | Merlin Combo | 69.95 | |
| All Products | CALL | BUSINESS SOFTWARE | | Activision | | Simon & Schuster | | |
| AST | | ALS | | Kitchen's Game Maker | | JK Lasser \$ Mng. | | |
| Multi I/O | 164.95 | Handler Pkg. | 104.95 | Baudville | | Terrapin | | |
| MegaRam + | CALL | Spellworks | 39.95 | Actors & Actions T1 | 34.95 | Timeworks | | |
| Sprint Disk w/mB | CALL | Apple | | Blazing Saddles | 23.95 | Silvia Porter \$ Planner | | |
| Checkmate Tech | | Appleworks | | Heroes & Villans T1 | 35.95 | Evelyn Wood Reader | | |
| Multiram II E 64K + 80 | 139.95 | Arrays | | Pixit | 35.95 | Unison | | |
| Multiram II E 256K + 80 | 179.95 | Home Accountant | | Prince Color (Epson) | 49.95 | Print Master | | |
| Multiram II E 512K + 80 | 229.95 | BPI Software | | Prince Color (Prowriter) | 49.95 | | | |
| Multiram II E 768K + 80 | 279.95 | AR, GL, PR, AP, IC (ea) | | Shape Lib. 1,2,3 (ea) | 13.95 | | | |
| Multiram II E 1024K | CALL | Prodos Versions (ea) | | Take 1 | 39.95 | | | |
| Multiram II 1280K | CALL | Broderbund | | Beagle Brothers | | EDUCATIONAL | | |
| Multiram II 1538K | CALL | Bank Street Writer | | Alpha Plot | 27.95 | Bantam | | |
| Multiram II 1792K | CALL | Bank Street Speller | | Apple Mechanic | 20.95 | Fantastic Animals | | |
| Multiram II CX w/256K | 249.95 | Bank Street Filer | | Bag | 20.95 | Road Rally USA | | |
| Multiram II CX w/512K | 299.95 | Bank Street Mailer | | Basic | 24.95 | Scarsdale Diet | | |
| Multiram II CX16 w/256 | 329.95 | Compuserve | | Big U | 24.95 | Barrons | | |
| Multiram II CX16 w/512 | 379.95 | Subscription Kit | | Graphics | 37.95 | Computer SAT | | |
| Multiview 80/160 | 224.95 | Market Analyzer + | | D-Code | 27.95 | CBS | | |
| Curtis | | Investors Workshop + 1lc | | Diskquick | 20.95 | Goren's Bridge | | |
| Diamond | 35.95 | Market Microscope | | DOS Boss | 18.95 | Mastering SAT | | |
| Emerald | 39.95 | News Retrieval | | Double-Take | 24.95 | Davidson Associates | | |
| Ruby | 59.95 | RE Analyzer III | | Extra K | 27.95 | Classmate | | |
| Disks | | w/Tax Prep | | Fat Cat | 24.95 | Math Blaster | | |
| Verbatim Bonus SS/DD | 12.95 | Human Edge | | Flex Text | 20.95 | Speed Reader II | | |
| Verbatim Bonus DS/DD | 16.95 | Mind Prober | | Font Mechanic | 20.95 | Data Disks A,B,C,D (ea) | | |
| Verbatim Datalifes SS/DD | 19.95 | Int'l Solutions | | Frame-Up | 20.95 | Alge Blaster | | |
| Verbatim Datalifes DS/DD | 25.95 | Mouse Budget | | GPLE | 32.95 | Spell It | | |
| Maxell MD1 SS/DD | 16.95 | Mouse Desk | | I.O. Silver | 20.95 | Word Attack | | |
| Maxell MD2 DS/DD | 24.95 | Mouse Word | | Mini Pix #1 | 20.95 | Data Grade(s)-(ea) | | |
| Flip 'n File 50 | 17.95 | Mouse Calc | | Pro-Byter | 24.95 | Designware | | |
| Kensington | | Intuit | | Pronto DOS | 20.95 | European Nations | | |
| Printer Stand | 19.95 | Quicken | | Shape Mechanic | 26.95 | Grammar Exam. | | |
| System Saver | 64.95 | Kensington | | Silicon Salad | 18.95 | Remember | | |
| Koala Technologies | | Format II | | Tip Disk #1 | 13.95 | Spellcopter | | |
| Koala Pad + | 77.95 | Think Tank | | Triple Dump | 27.95 | Spellakazam | | |
| Joysticks | | Manzanita | | Typefaces | 13.95 | States & Traits | | |
| Kraft | 39.95 | GL,AR,AP,IC (ea) | | Utility City | 20.95 | Body Transparent | | |
| Kraft Quicktrack | 54.95 | PR | | Borland International | | Electronic Arts | | |
| Hayes Mach III's | 39.95 | Business Master | | Turbo Pascal 3.0 | 42.95 | Cut & Paste | | |
| Quadram | | Megaheus | | Turbo Tool | 37.95 | Financial Cookbook | | |
| Microfazer P/P 128K | 169.95 | MegaWorks | | Turbo Tutorial | 25.95 | Movie Maker | | |
| Microfazer S/S 64K | 179.95 | Report Works | | Broderbund | | Fisher Price | | |
| Multicore W/256K | 299.95 | Microsoft | | Dazzle Draw | 42.95 | Alpha Build | | |
| ProDOS Clock Calendar | 69.95 | Multiplan | | Print Shop | 34.95 | 1st Man on Moon | | |
| Titan | | Monogram | | Print Shop Companion | 29.95 | Jungle Reading | | |
| Accelerator | 229.95 | Dollars & Cents | | Print Shop GL 1,2,3 (ea) | 19.95 | Logic Levels | | |
| 64K Ram | 159.95 | Dollars & Cents 1lc | | Print Shop Refill Paper | 13.95 | Peter R. Reading | | |
| 128K Ram | 184.95 | Forecast | | Central Point | | Peter W. Music | | |
| GRAPHIC INTERFACES | | Peachtree | | Copy II + | 24.95 | Sea Speller | | |
| Orange Micro | | Back to Basics | | Data Transforms | | Hayden | | |
| Grappler + | 84.95 | Back to Basics A/R | | Font Set(s) (ea) | | SAT Math | | |
| Grappler + w/64k | 154.95 | Back to Basics A/P | | Funk | | SAT Verbal | | |
| Grappler + RS-232C | 84.95 | Back to Basics G/L | | Sideways | | Harcourt-Brace | | |
| Grappler C | 89.95 | PBI | | Applesoft Compiler | | Computer SAT | | |
| Hot Link 1lc | 54.95 | JEEVES | | Basic Compiler | | Learning Company | | |
| Textprint | | Graphworks | | COBOL-80 | | Addition Magician | | |
| Print It | 134.95 | Quark | | Fortran-80 | | Bumble Plot | | |
| Thirdware | | Catalyst 3.0 | | M-Soft 80 | | Gertrudes Puzzle | | |
| Fingerprint + | 104.95 | Word Juggler 3.0 | | Microstuff | | Gertrudes Secrets | | |
| Fingerprint + IIC | 104.95 | Roger Wagner | | Crosstalk | | Juggle's Rainbow | | |
| PRINTERS DOT MATRIX | | Mouse Write | | | | Magic Spells | | |
| Apple* | | | | | | Moptown Hotel | | |
| Imagewriter II 10" & 15" | CALL | | | | | Moptown Parade | | |
| | | | | | | Number Stumper | | |
| | | | | | | Reader Rabbit | | |
| | | | | | | Robot Odyssey | | |

ORDERS ONLY 1-800-845-3003

any mail order price prices include all handling there's no hidden charge."

6 YEARS OF CONTINUOUS GOOD SERVICE

EDUCATIONAL

| | |
|-----------------------------|--------|
| Rocky's Boot | 34.95 |
| Word Spinner | 25.95 |
| Meca | |
| Managing Your \$ | 109.95 |
| Milliken | |
| Addition Seq. | 26.95 |
| Division Seq. | 26.95 |
| Word Processor | 47.95 |
| Mindscape | |
| Perfect Score | 49.95 |
| Keyboard Cadet | 29.95 |
| Lusher Profile | 29.95 |
| Bank St. Music | 37.95 |
| Bank St. Story B. | 29.95 |
| Pinpoint | |
| Micro Cookbook | 36.95 |
| Added Menu's (ea) | 13.95 |
| Quality | |
| Bag of Tricks II | 35.95 |
| Beneath Apple DOS | 17.95 |
| Beneath Apple Pro DOS | 17.95 |
| Random House | |
| Charlie Brown's ABC's | 29.95 |
| Charlie Brown Typing | 29.95 |
| Charlie Brown 1,2,3's | 29.95 |
| Garfield Dbl. Dares | 29.95 |
| Garfield Eat Words | 29.95 |
| Potato Head | 29.95 |
| Peanuts Math | 29.95 |
| Snoopy Writer | 29.95 |
| Snoopy Rescue | 29.95 |
| Scarborough | |
| Boston Diet | 54.95 |
| Build a Book | 29.95 |
| Build Refills 1,2 (ea) | 16.95 |
| Mastery | |
| New Improved | 29.95 |
| Figures & Formulas | 21.95 |
| Filer | 29.95 |
| Writing Wizard | 54.95 |
| Run for the \$ | 29.95 |
| Songwriter | 29.95 |
| Personal Net W. | 54.95 |
| Simon & Schuster | |
| Great Paper Air/P | 27.95 |
| Typing Tutor III | 35.95 |
| Softsync | |
| Kid Pro Quo | 30.95 |
| Model Diet | 28.95 |
| Personal Acct. | 37.95 |
| Spinnaker | |
| Adv. Creator | 23.95 |
| Alphabet Zoo | 24.95 |
| BW Wordproc. | 39.95 |
| BW File/Report | 39.95 |
| BW Spreadsh. | 39.95 |
| Counting Parade | 23.95 |
| Delta Drawing | 29.95 |
| Fraction Fever | 21.95 |
| Grandma's House | 21.95 |
| Homework Math/Word | 29.95 |
| Homework Writing | 29.95 |
| In Search of | 25.95 |
| Kids on Keys | 20.95 |
| Kindercomp | 20.95 |
| Math Busters | 23.95 |
| Snooper Trooper 1,2 (ea) | 25.95 |
| Story Machine | 27.95 |
| Sum Ducks | 23.95 |
| Trans | 23.95 |
| Springboard | |
| Early Games | 25.95 |
| Easy ABC | 29.95 |
| Fraction Factory | 23.95 |
| Graphic Expander VI | 29.95 |
| Mask Parade | 29.95 |
| Music Maestro | 25.95 |
| Newsroom Clip Art | 22.95 |
| Piece Cake Math | 25.95 |
| Puzzle Master | 25.95 |
| Rainbow Painter | 25.95 |
| Stickers | 25.95 |
| The Newsroom | 37.95 |
| Xerox/Weekly Reader | |
| Sticky Bear | |
| ABC | 29.95 |
| Basket Bounce | 29.95 |
| Pop | 29.95 |
| Math | 29.95 |

EDUCATIONAL

| | |
|--------------|-------|
| Numbers | 29.95 |
| Opposites | 29.95 |
| Printer | 29.95 |
| Reading | 29.95 |
| Shapes | 29.95 |
| Spellgrabber | 29.95 |
| Town Builder | 29.95 |
| Typing | 29.95 |

GAME SOFTWARE

| | |
|-----------------------|-------|
| Access | |
| Beach-Head II | 25.95 |
| Beach-Head | 25.95 |
| Activision | |
| Alcazar | 29.95 |
| Borrowed Time | 29.95 |
| Countdown to Shut. | 29.95 |
| Designer's Pencil | 29.95 |
| Ghostbuster's | 29.95 |
| H.E.R.O. | 29.95 |
| Master Lands | 29.95 |
| Mindshadow | 29.95 |
| Pitfall | 29.95 |
| Road Race | 29.95 |
| Rock N Bolt | 29.95 |
| Space Shuttle | 29.95 |
| Tracer Sanction | 29.95 |
| Zenit | 29.95 |
| Avalon Hill | |
| Under Fire | 41.95 |
| Avant Garde | |
| Dave Winfield | 29.95 |
| Blue Chip | |
| Barron | 29.95 |
| Millionaire | 29.95 |
| Squire | 34.95 |
| Tycoon | 29.95 |
| Broderbund | |
| Art of War | 29.95 |
| Championship Lode R. | 25.95 |
| Choplifter | 25.95 |
| Captain Goodnight | 25.95 |
| Fantavision | 35.95 |
| Karateka | 25.95 |
| Mask of Sun | 29.95 |
| Serpent's Star | 29.95 |
| Where in the World... | 28.95 |
| CBS | |
| Murder by Doz. | 28.95 |
| Datasoft | |
| Alternate Reality | 34.95 |
| Bruce Lee | 28.95 |
| Conan | 28.95 |
| Dallas Quest | 24.95 |
| Dig Dug | 21.95 |
| Goonies | 28.95 |
| Mr. Do | 28.95 |
| PacMan | 21.95 |
| Bard's Tale | 34.95 |
| Reach For Stars | 34.95 |
| 7 Cities Gold | 29.95 |
| Sky Fox | 29.95 |
| Golden Oldies | 27.95 |
| Epyx | |
| Rogue | 20.95 |
| Koronis Rift | CALL |
| Summer Games | 28.95 |
| Pitstop | 28.95 |
| Baseball | 25.95 |

GAME SOFTWARE

| | |
|--------------------------|-------|
| Summer Games II | 29.95 |
| Winter Games | 29.95 |
| Football | 29.95 |
| Temple Apshair | 21.95 |
| Eidoion | 29.95 |
| Crush, Crumble | 20.95 |
| Fax | 20.95 |
| Mission Impossible | 24.95 |
| Hayden | |
| Holy Grail | 35.95 |
| Sargon III | 35.95 |
| Infocom | |
| Cutthroats | 28.95 |
| Deadline | 33.95 |
| Enchanter | 28.95 |
| Hitchhiker's G. | 28.95 |
| Infidel | 31.95 |
| Mind Voyaging | 31.95 |
| Seastalker | 28.95 |
| Starcross | 33.95 |
| Sorcerer | 30.95 |
| Spell Breaker | 33.95 |
| Suspect | 30.95 |
| Wishbringer | 28.95 |
| Witness | 28.95 |
| Zork 1 | 28.95 |
| Zork 2,3 (ea) | 30.95 |
| Micro Lge. Sports | |
| Baseball | 29.95 |
| Gen. Mng. Disk | 29.95 |
| Microprose | |
| F-15 Strike | 25.95 |
| NATO Commander | 25.95 |
| Silent Service | 25.95 |
| Solo Flight | 25.95 |
| Crusade in Europe | 28.95 |
| Decision Desert | 28.95 |
| Conflict Vietnam | 28.95 |
| Kennedy Approach | 25.95 |
| Gunship | 25.95 |
| Acro Jet | 25.95 |
| Mindscape | |
| Hailey Project | 32.95 |
| Stephen King Mist | 30.95 |
| James Bond View K. | 30.95 |
| Forbidden Castle | 30.95 |
| Voodoo Island | 30.95 |
| Racter | 32.95 |
| Tink's Adventure | 22.95 |
| Tonk in Buddy Bots | 22.95 |
| Tuk Goes Town | 22.95 |
| Tinka's Mazes | 22.95 |
| Tinka's Sub. Fair | 22.95 |
| Crossword Magic | 35.95 |
| Deja Vu | 39.95 |
| Rambo Part II | 29.95 |
| Voodoo Island | 29.95 |
| One Step | |
| God's Best | 35.95 |
| Origin | |
| Ultima 3 & 4 (ea) | 41.95 |
| Mobius | 38.95 |
| Autoduel | 35.95 |
| Orge | CALL |
| Penguin | |
| Pensate | 19.95 |
| Quest | 25.95 |
| Swords Kadash | 25.95 |
| Transylvania | 25.95 |
| Crimson Crown (New) | 25.95 |

GAME SOFTWARE

| | |
|------------------------------|-------|
| Priority | |
| Forbidden Quest | 29.95 |
| Sierra On Line | |
| Frogger | 25.95 |
| King's Quest | 35.95 |
| King's Quest II | 35.95 |
| Black Caldron | 29.95 |
| Simon & Schuster | |
| Super Zaxxon | 26.95 |
| Frogger 3 Deep | 26.95 |
| Spy Hunter | 32.95 |
| Trapper | 32.95 |
| Sir Tech | |
| Wizardry 1 | 34.95 |
| Wizardry 2 | 28.95 |
| Wizardry 3 | 28.95 |
| Wizardry 4 | 29.95 |
| Rescue Raiders | 27.95 |
| Spectrum | |
| Gato | 28.95 |
| Spinnaker/Telarium | |
| Amazon | 29.95 |
| Dragon World | 29.95 |
| Fahrenheit 451 | 29.95 |
| Rendezvous w/Rama | 29.95 |
| Shadown Keep | 29.95 |
| Strategic Simulations | |
| Baltic 85 | 25.95 |
| Battalion Comm. | 29.95 |
| Battle Normandy | 29.95 |
| Carrier Force | 39.95 |
| Computer Ambush | 37.95 |
| Computer Quarterback | 27.95 |
| Computer Baseball | 27.95 |
| Geopolittque | 28.95 |
| Germany 85 | 39.95 |
| Imperium Galactum | 28.95 |
| Kampfgruppe | 39.95 |
| Mission Crush | 28.95 |
| N. Atlantic 85 | 39.95 |
| Objective Kursk | 28.95 |
| Operation Mkt. Gardn. | 35.95 |
| Phantaise | 30.95 |
| Questron | 34.95 |
| Reforged 88 | 39.95 |
| War with Russia | 54.95 |
| Gemstone Warrior | 25.95 |
| Mech Brigade | 39.95 |
| Broadsides | 28.95 |
| Six Gun Shootout | CALL |
| Battle of Anquetam | CALL |
| Colonial Conquest | CALL |
| Sublogic | |
| Flight Simulator II | 35.95 |

■ Payment: MC/VISA, Certified and Bank Checks processed same day, Personal & Co. checks 21 day clearing.
 ■ Purchase Orders: FOB NH, plus handling.
 ■ APO/FPO: FOB NH, plus 3% handling (min. \$5.00) Alaska/Hawaii
 ■ International: FOB NH, plus 15% handling (min. \$15.00)
 ■ Credit Card Security: MC/VISA orders which are to be shipped or billed to an address other than the card holders will be charged a \$5.00 security center verification fee.
 ■ Returns: All returns must have a valid RMA #. Contact customer service for assistance. Defective software will be replaced with precisely the same product. Defective hardware will be replaced or repaired. If a customer has ordered the incorrect product it may be returned, software will be charged \$8.50 S&H ad hardware \$16.50.
 ■ Compatibility: BCP does not guarantee machine compatibility.
 ■ Matches: BCP must list the product with a price. Products with call do not apply.
 ■ Misc.: Prices and availability subject to change.

CUSTOMER SERVICE
(603) 924-9406

BUSINESS COMPUTERS
OF PETERBOROUGH
Golan Co. Inc.
P.O. Box 389
Peterborough, NH 03458

MONTHLY SPECIAL

PRINTER RIBBON
6 Pack Special

| | Retail | BCP |
|-------------------|--------|-------|
| * Imagewriter | 49.95 | 24.95 |
| * Epson LX80 | 74.95 | 34.95 |
| * Epson FX80/85 | 49.95 | 24.95 |
| * Epson FX100/185 | 74.95 | 34.95 |
| * Okidata 192 Mac | 79.95 | 39.95 |
| * Okidata 92 Mac | 29.95 | 15.95 |

* Imagewriter Color Pac (Br, Pur, Bl, Gr, Rd, Yl) 59.95 29.95
+ 2.50 Shipping

ORDERS ONLY 1-800-845-3003

edited by Wendy Lea McKibbin, *inCider* staff

Tune In to Mindscape's Latest

By now you may have heard it on radio's Top Ten. "What's that?" you ask. It's *Win Back the Cup*, a song from Mindscape's latest adventure game, *The American Challenge: A Sailing Simulation*. The tune is on the flip side of a 45-rpm record that comes with the software. On the main side of the record an "old salt" explains the game and the fundamentals of sailing. But the flip side is purely for rock 'n' roll buffs. Tom Snyder, the same talented guy who wrote the software, composed and recorded *Win Back the Cup*. Snyder

has already had success in the music business with the song *Run for the Money*. His achievements in educational-software development are well documented, with hit titles such as *The Halley Project* and *The Other Side*.

One or two people can play *The American Challenge*. A match competition pits the top eight sailors against each other to win a trip to Perth, Australia, where the next America's Cup race will be held in 1987. The challenge is to regain American honor by beating the Aussies' best time.

But if the challenge of sailing is too much for you,

just kick back, and turn the record over. And who knows, if the music hits the top of the charts, Mindscape might appear next with a video on MTV.

A Fair Shake for Women and Minorities

Apple Computer plans to announce in April the recipients of its innovative "Next Steps" corporate grants. The program is designed to give students who have been dubbed "underserved" equal access to technology.

Specifically, this group consists of elementary- and high-school students who are economically disadvantaged or who represent ethnic or linguistic minorities. Also included in this classification are girls in math and science classes.

The Next Steps program

the substantive learning that takes place," Dr. Bowen says. "Too often this group of students experience only low-level applications of the computer, instead of having more creative learning opportunities."

According to Apple, fewer than 10 percent of the 500 applicants will receive equipment under the terms of the project.

Trade In and Upgrade

A new policy from Apple Computer may offer schools the incentive to upgrade old Apple II equipment.

Beginning last month, and running through December 31, 1986, schools can trade in Apple II, Apple II Plus, Apple III, IBM PCjr, TRS-80 Models II, III, and IV, and selected Commodore computer systems (monitor, CPU, and disk drive), as well as additional disk drives, certain IBM typewriters, and selected computer systems from other manufacturers. For each model returned, the school will receive credit toward the purchase of an Apple computer system. Depending on the make and model, credits on trade-ins can run up to \$200 for each system. To take advantage of the program, schools must order a minimum of five new Apple computers through Apple's Education Purchase Program, according to the company.

"We recognize the need for schools to upgrade the quality and functionality of their computers," says Jim Buckley, Apple's educational-channel manager. "Schools are making major, long-term investments in



is the brainchild of Apple's Dr. Barbara Bowen, whose earlier teaching career included several stints in inner-city schools. She has also noted with concern some recent surveys pointing to less-than-equal access to technology for many women and minorities. "Our interest is not just in the number of systems put into a school, but in

Courtesy of Comstock Inc./Mike & Carol Werner

computer equipment, and those investments must be protected. Apple intends to provide schools with that kind of security."

Apple will refurbish returned systems and sell them as used equipment through the Microcomputer Inventory Exchange, a Santa Barbara, California-based firm specializing in marketing renovated computers.

Actions Speak Louder Than Words

When it comes to proving your commitment to something, actions speak louder than words. Such was the case at the Apple World/Macintosh World Expo conference in January. Steve Wozniak, father of the Apple II, co-founder of Apple Computer, and now a consultant to the company, was supposed to represent Apple on a panel discussing the future of the Apple II. At the last minute the Woz apparently was sick, and his empty seat put a damper on the audience—but only briefly.

As the panel moderator was still apologizing for Wozniak's absence, in walked Apple president John Sculley. He came alone, unescorted by the usual coterie of public-relations people, and marched up to the podium. He said he was filling in for Steve. Apparently Sculley had learned that no one would be representing Apple Computer at the Apple II panel discussion, and he took it upon himself to show Apple's commitment to the product line.

Not even conference promoters knew of Sculley's plans. When he arrived at the door to the conference inCider

room, the show official refused to let him in because he wasn't wearing the proper badge. The holdup was only temporary, though. Once introductions were made, Sculley joined the panel to answer the question posed by the moderator: "If you were John Sculley, what changes would be made with the Apple II?"

Evidently no one expected the real John Sculley to be there.

A Strategic Alliance?

Apple Computer president John Sculley recently told attendees at the annual Minnesota Educational Computing Corporation

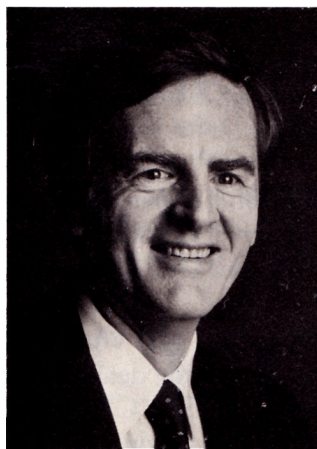

Apple Computer president John Sculley.

Courtesy of Apple Computer, Inc.

(MECC) consortium in Minneapolis, Minnesota, that Apple had made a "strategic alliance" between the II and the Macintosh.

Sculley discussed the problems caused by having two products with different architectures and no common data format. He then said, "We have a tremendous opportunity to bring the look and feel of the Macintosh to the Apple II." According to a company spokesperson, Sculley was referring to opportunities available to third-party developers to build the "human" or Mac-like interface into more II programs.

Sculley hinted that the Apple II and Macintosh would eventually share common peripherals, and that the II would continue to grow and "take advantage of many of the innovations of the Macintosh." He also said that users could look forward to an "exciting growth path" for more powerful Apple II workstations that would be fully compatible with existing IIe and IIc systems.

We're always looking for news of the Apple world. If you're making news, send your press releases and photographs to News Line, inCider, 1060 Marsh Road, Suite C-200, Menlo Park, CA 94025.

CALENDAR

April 7-11 TUTORIAL WEEK ORLANDO '86

Orlando, FL
contact:
Martez A. Camilleri
Director of Tutorials
IEEE Computer Society
1730 Massachusetts
Avenue N.W.
Washington, DC 20036-
1903
(202) 371-0101

April 11-12 19TH ANNUAL SMALL-COLLEGE COMPUTER SYMPOSIUM

Rapid City, SD
contact:
Dr. Dale Rognlie
South Dakota School of
Mines and Technology
Rapid City, SD 57701-3995
(605) 394-2511

April 13-14 MAINE COMPUTE-86

Bangor, ME
contact:
Doris Ray
Maine Computer
Consortium
P.O. Box 620
Auburn, ME 04210

April 15-17 INTERNATIONAL SECURITY CONFERENCE EXPO WEST '86

Los Angeles, CA
contact:
Gary Shono
c/o Cahners Exposition
Group
1350 East Toughy Avenue
Des Plaines, IL 60017
(312) 299-9311

Free software from Electronic Arts™

It's easy!

Buy any of these 12 smash hits from your participating dealer between February 1, 1986, and May 31, 1986. Then just mail in your proof of purchase, \$5 for shipping and handling, and the official "Get One Free" coupon. So what are you waiting for?

In case of emergency...

If you can't find a participating dealer, you can order direct from us by telephone or mail. Just call toll-free 800-245-4525. In California call 800-562-1112. Have your Visa or MasterCard number ready. Just tell us what you want to buy, and what you want for free. It's simple. And there's a 14-day "satisfaction or your money back" guarantee on all products ordered direct.

In case your participating dealer runs out of "Get One Free" coupons, use this.

cut here

Yes! I want free software from Electronic Arts!

No thanks. I'm using my computer as a doorstop.

(Check one)

Apple

II, II+, //c, //e

- Dr. J. & Larry Bird
Go One-On-One
- Archon
- Financial Cookbook
- Music Construction Set
- Pinball Construction Set
- Seven Cities of Gold
- Archon II: Adept
- Movie Maker

Commodore

64 & 128

- Dr. J. & Larry Bird
Go One-On-One
- Archon
- Financial Cookbook
- Music Construction Set
- Pinball Construction Set
- Seven Cities of Gold
- Archon II: Adept
- Movie Maker
- M.U.L.E.
- Realm of Impossibility
- Mail Order Monsters
- Racing Destruction Set

Atari

400-1200 series

- Dr. J. & Larry Bird
Go One-On-One
- Archon
- Financial Cookbook
- Music Construction Set
- Pinball Construction Set
- Seven Cities of Gold
- Archon II: Adept
- Movie Maker
- M.U.L.E.
- Realm of Impossibility

IBM

PCjr, PC, & comp.

- Dr. J. & Larry Bird
Go One-On-One
- Archon
- Financial Cookbook
- Music Construction Set
- Pinball Construction Set
- Seven Cities of Gold

Please send my free software to the following address. I have enclosed the required Proofs of Purchase and \$5 (check or money order payable to Electronic Arts) to cover the cost of shipping and handling (\$7 Canadian).

PLEASE PRINT

Name

Address

City State Zip

Phone () - -

Signature _____

Proof of Purchase. Send us the following two items: 1) the dated cash register tape or receipt showing the product you purchased, and 2) find the Command Summary or Reference Card inside the package you purchased. Cut off the part number on the back, lower-left-hand side of the card, or the product name from the front of the card. Send these two items and \$5 for shipping and handling (\$7 Canadian), along with the coupon, to **Electronic Arts, "Buy 1, Get 1 Free," P.O. Box 7530, San Mateo, CA 94403**. This offer expires May 31, 1986. Open to residents of the U.S.A. and Canada only. Only the products listed are available for this promotion. No substitutions will be accepted.

(no dogs included...)

Let's face it. Buying home software can be a risky proposition. Good software costs a lot of money. Cheap software practically rolls over and barks. But look at this. The titles listed below are Electronic Arts' greatest hits. They've all scored on the "top twenty" best-seller charts. Between them they've won over 60 product quality awards — making them the most honored products in the home software industry.

Best of all, there's no longer any reason to swallow hard when you think about treating yourself to quality software. Because now you can:

Buy 1, Get 1 Free.

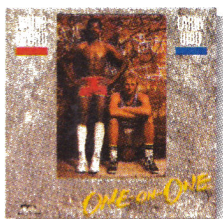

DR. J. & LARRY BIRD GO ONE-ON-ONE™

The best-selling computer sports simulation of all time.
"Game of the Year" — Electronic Games
Apple // family, C-64 & 128, Atari, IBM PCjr, PC, and comp.



PINBALL CONSTRUCTION SET™

Build your own video pinball games.
"Best Game Generator" — Infoworld
Apple // family, C-64 & 128, Atari, IBM PCjr, PC, and comp.



MUSIC CONSTRUCTION SET™

Composition for anyone who can point a joystick.
"Best Music Generator" — Infoworld
Apple // family, C-64 & 128, Atari, IBM PCjr, PC, and comp.

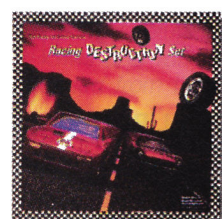

RACING DESTRUCTION SET™

Land mines, oil slicks, animated spin-outs, collisions and crashes.
"... the ultimate racing game..."
— Computer Entertainer
C-64 & 128.



SEVEN CITIES OF GOLD™

Play Conquistador in this educational adventure of history and geography.
"Best Role-Playing Adventure"
— Family Computing
Apple // family, C-64 & 128, Atari, IBM PCjr, PC, and comp.



ARCHON™

Like chess with arcade battle action.
"Game of the Year"
— Creative Computing
Apple // family, C-64 & 128, Atari, IBM PCjr, PC, and comp.

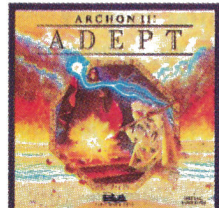

ARCHON II: ADEPT™

Graduate school for Archon addicts. Even more strategy and magic.
"Best Strategy/Arcade Game"
— Family Computing
Apple // family, C-64 & 128, Atari.



MAIL ORDER MONSTERS™

New. Like an "Archon Construction Set."
"Best Construction Set"
— Family Computing
C-64 & 128.



MOVIE MAKER™

Create your own high-quality animated movies.
"A masterpiece."
— Creative Computing
Apple // family, C-64 & 128, Atari.

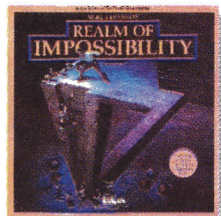

REALM OF IMPOSSIBILITY™

Action and adventure in a world of Escher-like illusions. Includes a unique 2-player cooperative mode.
C-64 & 128, Atari.



M.U.L.E.™

The best multi-player computer game of all time.
"Best Strategy Game" — Infoworld
"Best Multi-Player Game"
— Electronic Games
C-64 & 128, Atari.

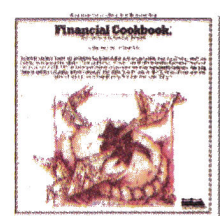

FINANCIAL COOKBOOK™

Take control of your personal finances. Like a calculator, spreadsheet, and financial advisor combined.
Apple // family, C-64 & 128, Atari, IBM PCjr, PC, and comp.

Remember—this offer is good only on these 12 products for the Apple // family, C-64 and 128, Atari, and IBM PC, PCjr, and compatible computers. No substitutions will be accepted. For details, see the accompanying coupon.
For a complete Electronic Arts Catalog, send 50¢ and a stamped, self-addressed envelope to Electronic Arts Catalog, 1820 Gateway Drive, San Mateo, CA 94404.
IBM is a registered trademark of International Business Machines, Inc. Apple // is a registered trademark of Apple Computer Inc. Commodore 64 & 128 are registered trademarks of Commodore Business Machines, Inc. Atari is a registered trademark of Atari Computer Corp. Electronic Arts, Dr. J & Larry Bird Go One-on-One, Financial Cookbook, Music Construction Set, Pinball Construction Set, Seven Cities of Gold, Archon II — Adept, Movie Maker, M.U.L.E., Realm of Impossibility, Mail Order Monsters, and Racing Destruction Set are registered trademarks of Electronic Arts.



Circle 148 on Reader Service Card.

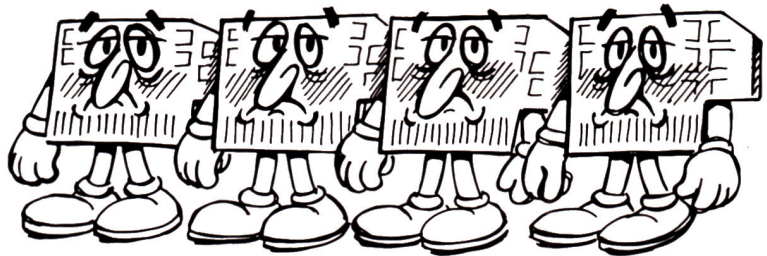

CONFUSED

about RAMCARDS?

DON'T BE!

Check out the **IMPORTANT** facts and the decision will be easy!
FLIPSTER, the ONE MEGABYTE RAMCARD from CIRTECH answers ALL the questions
Do the other RAMcards?

| | flipster | OTHERS |
|---|----------------------|---------------|
| IS IT DESIGNED TO THE NEW APPLE STANDARD | ✓ | ? |
| CAN IT BE USED ON AN APPLE IIe or II+ | ✓ | ? |
| IS IT AUTOMATICALLY RECOGNISED BY ProDOS, PASCAL 1-3 & CP/M PLUS | ✓ | ? |
| DOES IT COME COMPLETE WITH RAMDISK SUPPORT FOR CP/M 2-20B, 2-23, PASCAL 1-1, 1-2 & DOS 3-3 | ✓ | ? |
| IS IT 100% COMPATIBLE WITH ALL STANDARD APPLE II SOFTWARE ALLOWING FULL USE OF POTENTIAL MEMORY | ✓ | ? |
| IS IT FULLY COMPATIBLE WITH APPLEWORKS. VERSION 1-3 GIVES A DESKTOP OF 1012K! | ✓ | ? |
| ARE ProDOS, DOS 3-3, PASCAL 1-3 & CP/M BOOTABLE DIRECT FROM THE RAMCARD | ✓ | ? |
| WHAT'S THE TOTAL MEMORY POSSIBLE IN YOUR APPLE | SIX MEGABYTES | ? |

And we don't stop there! **FLIPSTER** offers another winning feature – THE PROGRAM MANAGER – you won't find it among the competition, it's unique to **FLIPSTER**

The PROGRAM MANAGER enables you to organize **FLIPSTER** into convenient workareas and switch between these areas with JUST A FEW KEYSTROKES. Each workarea can contain programs and/or operating systems – imagine, you can switch from APPLEWORKS to PASCAL to dBASE to DOS faster than you can say **FLIPSTER**. With the facility to backup complete workareas for quick and easy restoration next time you use them, **FLIPSTER** is the most advanced multi-program tool available for your Apple.

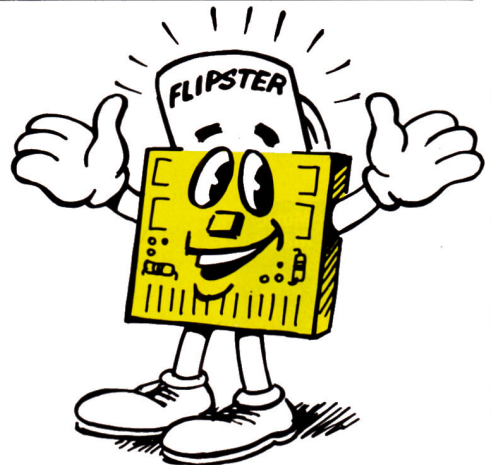

DON'T SETTLE FOR LESS – ONLY \$399.00



SOURCE Mailbox Nos.: CIRTECH – AAH555

products are available from

GREENGATE inc
productions

GREENGATE – BCH101

2041 Pioneer Crt. # 15, SAN MATEO,
 CA 94403 Tel: (415) 345 3064

Apple, Appleworks, ProDOS and DOS 3.3 are registered trademarks of Apple Computer Inc.
 dBASE is a registered trademark of Ashton Tate
 CP/M and CP/M Plus are registered trademarks of Digital Research Inc.
 *CIRTECH (UK) LTD are in no way affiliated with Sir Tech Software Inc.

APPLE CLINIC

by Jim Sather

The Apple Clinic is a forum for discussing Apple II hardware and related subjects. If you have questions or answers, or want to make a statement, write to Jim Sather, Apple Clinic, inCider, 80 Pine Street, Peterborough, NH 03458.

Patch Central

I sure need help! I'm having problems using the full 652K capacity of my Rana Elite Three disk drive with my programs. I was told I need to patch the Rana DOS onto my program disks, but I've had little success in my attempts to do so. Since Rana is now out of business, I'm unable to get help anywhere. I use Apple Writer IIe, the PFS programs, Dow Jones Market Analyzer, Fund Master-TC, and VisiCalc.

Tom Cioch
Dearborn Heights, MI

Yours is an example of many letters I get asking how to make software work with hardware it wasn't designed to support, Tom. These requests cover a great variety of hardware and software, the majority of which I don't own or use. In most instances, including yours, it's probably possible to patch the software to make it work with the hardware, but I cannot realistically spend the required days or weeks developing and documenting the modifications.

Still, I regret being unable to help correspondents like you who have legitimate needs and have turned to Apple Clinic for assistance. In response to those needs, I'm establishing Patch Central, a service in which Apple Clinic disseminates information about patches and software modifications inCider readers have developed.

My idea is for readers to send documentation for patches and modifications they know of or have developed to Apple Clinic. I'll briefly

inCider

describe each patch in Apple Clinic and identify its sender. I'll include any patch that seems to improve software performance, but it's my experience that the patches people want are those that provide hardware capabilities or support the original programmer overlooked.

My plan for distributing the patch information is to charge a fee of about \$2 to readers requesting documentation for a patch. This fee will cover my costs and time, plus a \$1 honorarium I'll send to the patch provider. Nobody is getting rich here, but contributors should at least get ice-cream money for their efforts. I'll also print documentation for selected (read: brief, but helpful) patches in Apple Clinic.

Patch Central is a chance for readers to share their hard work with the community of Apple II users. I know many of you normally don't have the time to write letters to magazines, but I hope that a significant number of you will contribute information for the benefit of others faced with the same problems you overcame. Needless to say, Patch Central will succeed only if readers contribute. If you have a patch, send a copy of its documentation to me at Apple Clinic, attention Patch Central.

Printer Buffer Schematic

I've had my Apple IIe for a little more than a year and have been delving into electronics recently. I'd like very much to build a printer buffer, but can't find schematics to help me. Do you know where I can find schematics for a simple printer buffer? I have an ImageWriter printer and Apple Super Serial interface card.

Leslie S. Newman
Richmond, VA

Bill Green presented a 64K in-line printer buffer in the August and September 1985 issues of Radio Electronics. This buffer is actually a Z80-

based microcomputer with 64K RAM and 2K EPROM that's capable of accepting Centronics parallel or RS-232 serial print data. The setup can also program EPROMs and run Z80 programs downloaded from the host computer.

The hardware description in the Radio Electronics article is excellent, but gives no EPROM firmware listings or descriptions. You can purchase the controlling EPROM for \$26. If you don't want to build the buffer from scratch, you can purchase the complete kit for \$139. For more details, see the issues mentioned.

A novel idea for a printer buffer appeared in the August 1985 Apple Assembly Line. David C. Johnson connected the output of the Super Serial card in his IIe to serial port 2 on his IIc, and an ImageWriter to port 1 of the IIc. This setup routed all IIe print output to the printer via the IIc, which David beefed up to 640K via an Applied Engineering Z-RAM assembly. David presented software that used the IIc as a 576K printer buffer for the IIe.

This scheme works great if you don't normally need your IIc for other things while the IIe is generating printouts: The IIe never waits for printouts, and one printer serves two computers. Those with technical skills could devise similar schemes for using other light-duty computers (an old Apple II Plus, for instance) as printer buffers for heavy-duty computers.

Scribe Information

This letter is in response to Brian Symonds' letter about jammed Scribe ribbon cartridges ("Jammed Scribe Cartridges," Apple Clinic, September 1985, p. 58). I've had this difficulty many times, especially early in 1985. It's definitely a problem with the cartridges. It's nearly impossible to move a stuck ribbon with the ribbon-advance knob on the cartridge. Sometimes, removing the cartridge and

slapping it solidly against the palm of your hand helps.

My dealer has always replaced these cartridges—no questions asked—upon return of the defective ones. In fact, I had so much trouble that I used "free" ribbons for about two months. Examination of lot numbers stamped on the cartridges showed that the problem is common to many different lots.

Brian's dealer is apparently charging him for color ribbons at \$9.95. I found I could improve on the \$6.25

price by purchasing them in lots of six or 12.

I use an inexpensive impact-type dot-matrix printer, except when I want exceptional print quality. My accounting clients like the Scribe's letter-quality printing. One likes it even more than the print from his \$1500 daisy-wheel printer. I also find that graphics printed on the Scribe come out very dark and glossy. This makes them excellent originals for photocopying and offset printing.

I have a few hints for living with the Scribe:

- Use thermal paper such as that for the Silentype (roll) or the IBM thermal printer (fanfold). Or use the thicker thermal paper used on the Brother line of typewriters; the thinner paper some Brother dealers sell jams. Thermal paper is adequate for most draft work, and you don't need a ribbon.

- For best-quality print with a ribbon, use thermal-transfer paper. Hammermill sells one type, as does Shanin Graphics (ByteWrite thermal-transfer paper). Radio Shack catalog no. 26-1427, 20-pound white paper produces nearly equal quality. With any of these, be sure to print on the smoother side; even regular paper may have one side that's smoother.

- Use only the normal print-density setting on the DIP switches unless you absolutely need higher density.

- Clean the platen frequently. This is most important. I clean mine every two weeks.

- The head is user serviceable. If you get a wax buildup (I never have), remove the head and clean it off.

John R. Murphy
Downey, CA

As an Apple dealer tech-support person, I've encountered this problem several times, and it can be traced to the DIP-switch settings for paper thickness; it's not a manual adjustment at all. To clear up the ribbon meltdown, follow the printer-manual instructions for setting switches 3 and 4 to low-density paper.

Wax buildup on the print head occurs after the ribbon has peeled back on itself. The wax doesn't normally come into contact with the print head, since the wax is only on the paper side of the ribbon. [*But what if a hole is burned in the ribbon?* —J.F.S.]

The price difference (\$6.25 versus \$9.95) on the Scribe ribbons can be attributed to the Canadian dollar and the federal sales tax in Canada, although our price is \$7.95 for original Apple Scribe ribbons.

The Apple Scribe is economical up to about 75 pages per month, and the near-letter-quality mode is excellent for quality output. For more than 100 pages per month, I consider the ImageWriter the most economical buy.

Jeff Shields
Thunder Bay, Ontario

Is Your Apple Making You Money?

Across the country a growing number of Apple computer users are participating in the most exciting phase of the telecommunications explosion.

They are creating their own highly sophisticated yet easy-to-use electronic databases that are both interactive and profitable.

Any //e or //c can now be turned into a sophisticated on-line Databoard and money making Information Center with the addition of a modem and the inexpensive Databoard program called **Let's Talk™**

The Big Information Utilities are not the only ones who will profit by providing information on-line. They can't compete on the local level with local Information Centers (who wants to call CompuServe to find out what's happening across town when a local call will bring you more).

Every community has a need for an on-line Information Center and Databoard offering Restaurant Guides, Movie Listings, Classified Ads, Calendars of Events, Business Information, and an Electronic Mall.

This is your chance to join the growing number of Apple owners who profit from operating Local Databoards and Information Centers.

METRONET ATLANTA NEWSCOM SAN ANTONIO CLM
BAYLORNET DALLAS AUDIOPHILE VAN NUYS HORTON
SOFTWARE EMPORIUM COMPUTER ROOM THOUSAND OAK
GOLDEN DISK STUDIO CITY TANEYCOMO PRODUCTIONS
VIDEO HOTLINE HOLLYWOOD APPCOMNET SAN JOSE
TELEPORT JACKSONVILLE ASHBUROUGH ACCESS

Let's Talk:™ It works while you're away

Available at your local dealer or from RUSS Systems for \$175.00
Contains the finest Text Editor and Disk Utilities available today.
Non copy-protected, hard-disk compatible, PROdos™ //c //e-128K
Use your computer to call for more information and a demonstration.



RUSS Systems
320 Dufour St.
Santa Cruz, CA 95060



408/
427-
1540



408/
427-
0310

Circle 46 on Reader Service Card.

I discovered the problem was a burned print head, which you can replace for about \$6, or which a service technician can replace for an additional \$65 labor. My printer was only three months old when the problem occurred. Apple people couldn't tell me what to do, so I figured it out myself. Since identifying and correcting the problem, I've had no problems with jammed ribbons. Scribe owners should note that the cartridges last for only about 35 pages of near-letter-quality printing. [Sixty-five dollars to replace a user-replaceable part??? —J.F.S.]

Joseph F. Laino
Springfield, MA

I was getting quite mad at my jammed ribbon cartridges until I took out my frustration in a letter to Apple. The company sent me a free cartridge and asked me to try it out. It worked. Later, I was happily surprised to receive a follow-up call from a young man at Apple. He said they had difficulties with some ribbons that had come out of Dallas and Chicago, and they suspected cold weather

caused the problems. He suggested that I check the print head for wax buildup (there wasn't any) and that perhaps the tape was spiralling as it wound up and I should attempt to realign it (I smack them on the table and they work fine). He also told me that the suggested price of a cartridge is now \$5, and that I should expect 40 full pages of print per ribbon as the Scribe prints in test mode, edge to edge and top to bottom. [If anyone ever publishes a phone book of helpful Apple employees, I'll be first in line. —J.F.S.]

Pat Hathaway
Topeka, KS

I have the same problem as Brian Symonds, but with only about one out of ten ribbons. He must have some other hardware problem. I'm a writer and get up to 70 double-spaced pages per ribbon. This works out to about seven cents per page, since my dealer carries the ribbons for \$4.99 (and replaces bad ones free). The color ribbon produces about 10-12 pages from Dazzle Draw for \$6.99.

The versatility, performance, and

low cost of the Scribe outweigh the disadvantages of the disposable ribbon. The Scribe is everything Apple says. The company just doesn't tell you about the ribbons.

Mike Holloway
Baton Rouge, LA

The Scribe performs satisfactorily except for cost per printed page. My solution is to print rough drafts on thermal paper with no ribbon, then install a ribbon cartridge and 20-pound bond paper for a high-quality final draft. I use IBM PC compact printer paper, p/n 1503924, 250 fanfold pages per pack. The cost is about seven cents per sheet. I wish someone produced fanfold, tractor-feed thermal paper. [The thermal paper printout sample is adequate for rough draft. —J.F.S.]

Terry B. Forester
Grandview, MO

Brian Symonds' letter generated the greatest volume of knowledge-packed correspondence I've yet received in my first year of presiding over Apple Clinic. I could have devoted this entire

SPELL CHECKER AND MAILMERGE FOR APPLEWORKS

Now... the luxury of a spelling checker and mailmerge for only \$49.95!

Spellworks was written exclusively for Appleworks... it fits Appleworks like a glove. Typing and spelling errors are a thing of the past when you use Spellworks!

... I am impressed by Spellworks, not only because of the errors it detects, but also for the number of errors which it does not detect. By this I mean that it has a powerful vocabulary, and it recognizes a large number of variations of words so that it does not incorrectly call errors. The program is easy to use. I didn't even have to use the manual which came with the program. Good job and keep up the good work

Manager, Electrical Engineering Kenneth McCuen
Solitec, Inc., Santa Clara, CA

If you've got Appleworks, you need Spellworks. It's a steal — spelled s-t-e-a-l!

- Utility that merges Appleworks Data Base with Appleworks Word Processor.
- 90,000 Words
- Checks 10 words per second
- Word count 10 per second
- All on one diskette!

ONLY \$49.95!

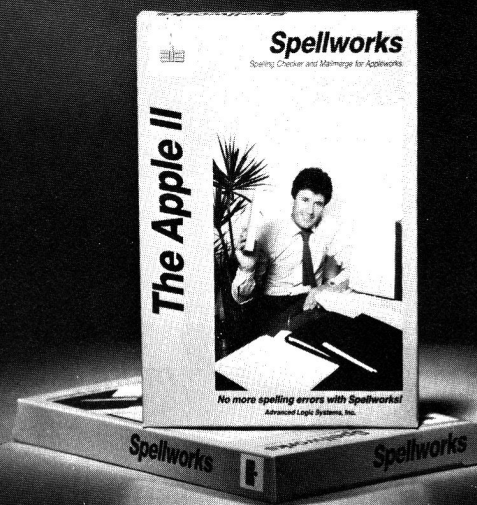

... now with Spellworks
no more spelling errors!

Advanced Logic **als** Systems, Inc.

1195 E. Arques Avenue • Sunnyvale, CA 94086 • 408/730-0307

column to these letters. Instead, I've printed a selected few and have sent copies of all letters to Brian, the other Scribe correspondents, and Apple.

The letters I received provided a fair sample of Scribe printout. The Scribe prints some nice images, but I was disappointed to see fading (as if a ribbon had been used too long) in the majority of the letters. The printouts looked almost as if someone had made photocopies of daisy-wheel output.

From all this correspondence, I also discovered a second negative aspect of Scribe printouts. All the letters I received were folded to one-third size and mailed in legal-sized envelopes. Where the surfaces were pressed together, the printed images were transferred from one surface to the other. The transferred text ranged from barely discernible to quite readable, and the overall effect made the letters appear dirty or ink-smeared.

Most correspondents expressed satisfaction with the Scribe, but I have serious reservations about it. My opinion

of the text quality is not as high as some of theirs, and their hassles with ribbon cartridges seem daunting.

Apple //c Modem Problems

I own an Apple //c and Apple 300 modem and get hundreds of garbage characters when my computer is connected to local bulletin boards. This seems to happen most often with Apple //e boards using Hayes modems. I'm also unsuccessful at downloading programs with Hayes, Apple Cat, and several other modems. I've tried every terminal program on the market with no success.

My dealer checked out my modem and told me it was fine. He claims he successfully called Tymnet and accessed Dow Jones. He said he couldn't be responsible for every little modem.

Can it be that my motherboard is bad? I've heard that there was a crystal problem, but my dealer assures me that isn't it.

Scott Segura
Jacksonville, FL

Apple //c's manufactured prior to January 1985 do have a problem: Apple modems will communicate with each other, but not with modems of other manufacturers. The problem is indeed associated with crystal frequencies, but has been corrected in all //c's with serial numbers greater than D51000.

If your serial number is less than D51001, you have the modem-frequency problem, and authorized Apple dealers will correct it free of charge. All authorized Apple dealers have the guidelines for doing this in the Apple //c section of Apple publication 072-0062, p. 0.3. Point this out to your dealer if he continues to maintain that there isn't a problem.

Blooming Monitor

One day, while I was programming in 80-column mode, the display on my Apple green-screen monitor started to wave and distort. Soon, the screen started to "grow," in the sense that the letters became larger and distorted. The problem was still there in 40-column mode, but it went away when I tried my color monitor. I've noticed that the problem goes away when the monitor cools down, but comes back when the monitor heats up again.

I'd like to know why this happens and if I can get it fixed without replacing my monitor. I really need the 80-column display. The warranty on the monitor has expired.

Ivan Samuelson
Yorktown, IN

You are describing a classic CRT symptom called "blooming," which is normally caused by a faulty high-voltage power supply in a monitor or television. It's the kind of thing a competent technician can repair, but not the sort of thing you can handle yourself. Take the monitor to a full-service computer dealer, and tell the repair people not to fix it if the cost exceeds a limit you've set.

The limit should be what your old monitor is worth to you, probably \$50-\$80. I personally wouldn't spend more than about \$50 to repair an old monochrome monitor, since you can buy a pretty snazzy new one for \$100-\$150 if you shop around. It's just a guess from where I sit, but I suspect you can get your monitor repaired for less than \$50.







CHART

Construct bar, line, pie, scatter, XY, and area charts or any combination of the charts shown.

LETTER

Add titles, labels and other lettering in 40 fonts and many sizes and colors.

DRAW

Create custom drawings. Modify your drawings or drawings of others. Move things around and transfer, merge or reduce picture sections. "Paint" in over 100 colors.

SHOW

Present a "slide show" of up to 32 pictures on monitor or TV screen. Subtitle pictures. Select "slides" manually or automatically in a pre-timed presentation.



It's almost like having your own graphic artist!

Try the new, improved and more complete **GRAPHICS DEPARTMENT™**

Available for Apple Computers for \$124.95.



Sensible Software® Inc.

210 S. Woodward,
Suite 229,
Birmingham, MI 48011
(313) 258-5566

Apple is a trademark of Apple Computer, Inc.

Another Clobbered Disk

I'm unable to load one of my AppleWorks data disks. When I check for bad blocks with the ProDOS utility disk, it tells me that block 3 is bad. Is there anything I can do to retrieve the data on this disk or have I lost this information forever?

James A. Barker
Saint Cloud, FL

It's possible to retrieve all of your data except for those on the clobbered sector. Here is a method using Copy II Plus from Central Point Software:

- 1) Format a blank disk using the **FORMAT** command.
- 2) Copy tracks \$1-\$22 from your damaged disk to the blank disk using the bit copier.
- 3) Copy each sector of track zero from the damaged disk to the new disk using the sector editor: First read the sector, then switch disks and write the sector.

You'll be unable to read sector 8 or 9, or both, since these sectors make up ProDOS block 3. Just transfer the track-zero sectors that can be read. Data on the unreadable sector are lost and replaced by a sector filled with zeros, since you formatted the new disk as a first step.

If you have a thorough knowledge of disk formats, you might be able to partially recover the data in the damaged sector using a nibble editor like that in Copy II Plus or Locksmith 5.0. With such knowledge, you should be able to spot an address-field checksum error or other correctable error.

You might also consider buying Life-saver from MicroLab. Joseph G. Lossick of Columbus, Ohio, emphatically recommends this program for repair of disk-I/O problems. He says that Life-saver is powerful, but suited for novices. Lossick also recommends Ultradisk Test from Computer Advanced Ideas for detecting benign read/write errors before they are bad enough to cause I/O errors.

Apple //c Keypad

I just purchased an Apple //c and would like to have a numeric keypad for it. Do you know if anyone makes such an accessory for the //c?

Ed Heinen
Bison, KS

I don't think anyone is marketing an external keypad or keyboard for the Apple //c, simply because the computer lacks an external key jack in the back. As a result, any commercial keypad would require you or your dealer to open the cabinet, install the keypad connector between the internal keyboard connector and motherboard keyboard jack, and route a connecting cable through the cabinet to the external keypad. The result would be electrically simple, but mechanically clumsy and completely

out of line with the concept of a closed-lid portable computer.

If, despite the negative aspects, you want an external keypad for your //c, you can connect a //e keypad to the //c through an adapter I've devised (see the accompanying **Figure** and **Photo**). The heart of this adapter is a 34-pin break-out connector that lets you tap into the //c keyboard-matrix signals while leaving the keyboard connected. Matrix lines X4-X7 and Y0-Y5 of the //c are connected to the same lines on the

FIRST TOTALLY PORTABLE APPLE //c

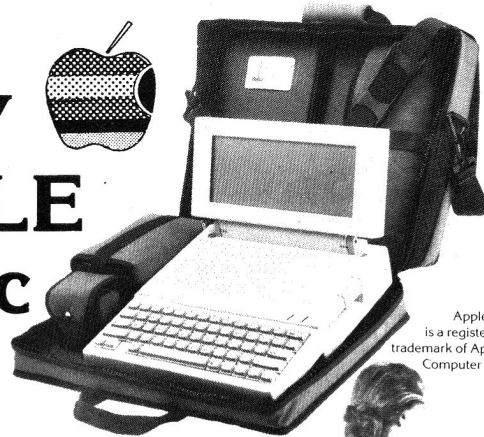

Take it with you
everywhere!

System Features:

- 24 Line by 80 Character LCD Display
- 8 Hour rechargeable power supply
- 21 lb. total system weight including //c
- Durable Cordura carrying case with handle and shoulder strap

Check These *New* Low Prices:

- | | | |
|---|-----------------|--------|
| • C-VUE Flat Panel Display | REDUCED! | 399.00 |
| • PRAIRIE POWER Battery Pack and Case | REDUCED! | 150.00 |
| • Checkmate 512K Multiram™ CX Board | REDUCED! | 285.00 |
| • Apple //c Computer (only available in combination with other products listed) | | 750.00 |
| • Apple //c Computer and //c Monitor and stand (only available in combination with other products listed) | | 850.00 |
| • NEW! Proclock //c (internal) | | 149.00 |
| • NEW! Checkmate 512K Multiram™ CX Board w/16-bit processor | | 399.00 |
| • NEW! Apple //c Cigarette Lighter Adapter | | 19.95 |
| • NEW! Apple //c Power Extension Cable | | 11.95 |
| • NEW! Apple //c Power Y-Adapter | | 12.95 |



Apple //e,
Macintosh
peripherals
also available.

14-day
money-back
guarantee

Ordering Information:

1-800-GET-CVUE (outside California)
(619) 274-1253 (within California & outside U.S.)
MasterCard and VISA accepted.

Checkmate Technology, Inc.

ROGER COATS P.O. BOX 171466 SAN DIEGO, CA 92117



Prices subject to
change without notice.



**IS YOUR APPLE //
WORD PROCESSOR
LETTING YOU DOWN?
STEP UP TO
GUTENBERG®
SR**

IF YOU NEED...

customized screen fonts - to display up to 115 extra user-defined characters on the screen and print them as special 7x12 dot graphics in your text, automatically.

downloaded printer fonts - to dynamically change the printer's character set. Gutenberg supports font downloading into the Apple Imagewriter or DMP of up to 21 different fonts at 14 print pitches in proportional print mode and still micro-justifies the print line.

special alphabets - to print text in many different languages, including: Danish, Finnish, French, German, Greek, Hebrew, Italian, Polish, Russian, Spanish, Swedish, Syriac, Ukrainian, etc.

scientific symbols - for any type of technical writing.

graphic pictures - embedded in your text, banner headings for newsletters or letterheads, or big display lettering.

flexible print layouts - for best reproduction of your document. Gutenberg's advanced formatting language allows unrestricted placement of text.

**GUTENBERG® SR
IS THE ANSWER!**

Gutenberg runs on all Apple // computers or compatibles with 64K of memory. Gutenberg supports the Apple Imagewriter and Apple DMP with printer font downloading, the C.Itoh Prowriter, the NEC 8023, all Epson MX-100 compatibles with regular graphics, and most letter-quality printers without the graphics option.

To request your
FREE 16-page booklet
"Your Introduction to
Gutenberg JR + SR"

write to:

Gutenberg Software Limited
47 Lewiston Road
Scarborough, Ontario
Canada - M1P 1X8

or phone: (416) 757-3320

or circle the appropriate number
on the Reader Service Card.

Apple is a reg. trademark of Apple Computer, Inc.

Figure. Schematic showing connections between the //c keyboard plug and the //e numeric-keypad plug.

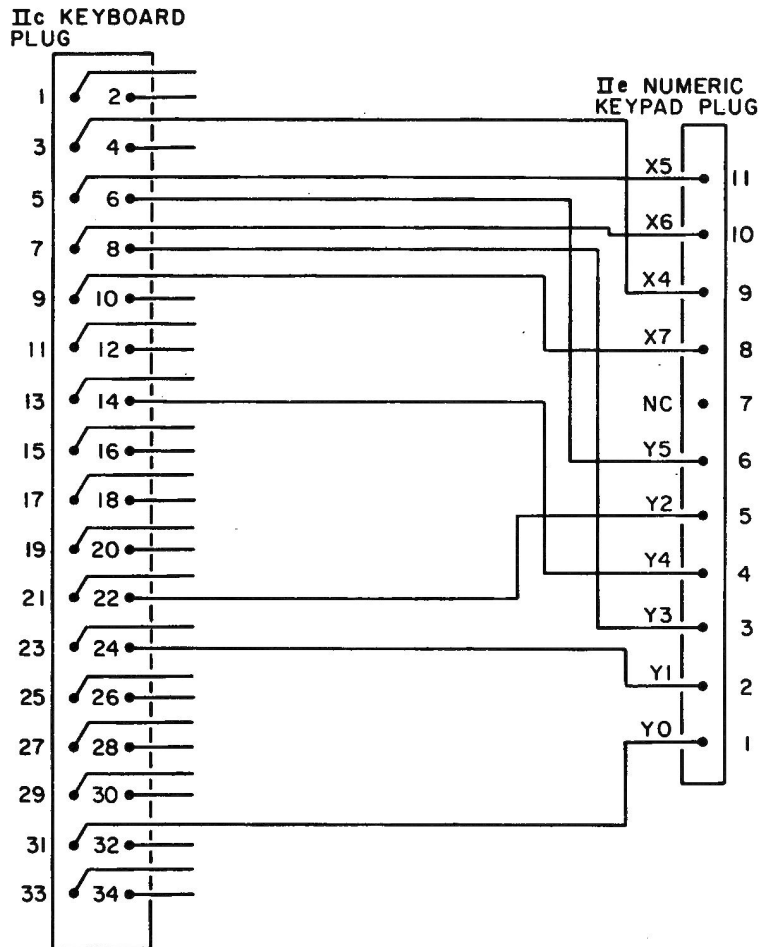

//e keypad. The //e keypad operates correctly since the //e and //c keyboard ROMs are identical.

You need an 11-pin single-row male jack, a 34-pin single-ended header/ribbon-cable assembly, and a 34-pin AP Products intra connector to build the adapter (see the **Table**). I purchased the parts from Digi-Key Corporation (approximately \$18), but you can probably find them from other sources.

Break off an 11-pin section from a 36-pin male header to form the 11-pin

male jack. Cut back the unused wires and solder the X4-X7 and Y0-Y5 wires to the 11-pin jack as shown in the schematic and photograph. Join the cable assembly and intra connector as shown, and install the adapter between the keyboard cable and keyboard jack inside the //c.

Table. Digi-Key adapter parts.

| Part | Part Number | Price |
|--------------------|--------------|---------|
| Intra-Connector | 922576-34 | \$11.00 |
| Cable assembly | R314G-36-ND | 4.12 |
| 36-pin male header | 929834-01-36 | 1.60 |

Digi-Key Corporation, P.O. Box 677, Thief River Falls, MN 56701, (800) 344-4539.

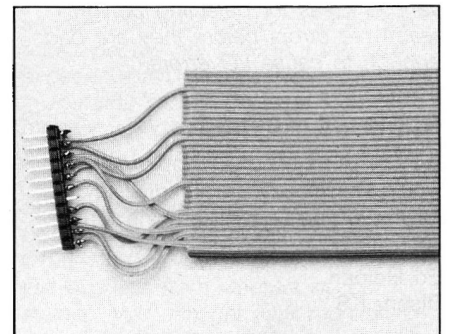

Photo. Adapter for connecting an Apple //e keypad to an Apple //c.

What every Apple II+ and IIe user should ask before buying the "Sider" 10 MB hard disk:

When a company offers a superior quality 10 megabyte Winchester hard disk for only \$595, it's bound to raise a few eyebrows... and a lot of questions. The first is, you're probably already wondering "Can I really get a 10 megabyte hard disk that's *reliable* for only \$595?" The answer is: ABSOLUTELY... when you choose the Sider from First Class Peripherals.

What's so great about the Sider?

For starters, the Sider lets you boot your *Apple II+* or *IIe* directly off the hard disk—unlike some other Winchester subsystems. Rebooting is also trouble-free. And the disk is partitionable, allowing you to allocate space to four operating systems on the same disk. The Sider supports: Apple DOS 3.3; Pro DOS™; Apple Pascal; and CP/M®.

What's more, a small "footprint" lets you incorporate the compact Sider into your existing computer set-up with ease.

In addition, with the Sider, you not only pay far less for the subsystem, you also save money on installation. Because, unlike other 10 MB systems that require the purchase of expensive "extras," the Sider is *plug and play*. Everything you need is provided, including cables, host adaptor, installation software and manual.

What makes it so reliable?

To start, the Sider is manufactured, and sold exclusively, by First Class Peripherals, an innovative computer company which is backed by Xebec. The computer industry's leading manufacturer of disk controllers, Xebec has over a decade of experience serving customers like IBM, Toshiba, Texas Instruments and Hewlett Packard. It's this kind of expertise that helps assure the Sider's performance.

Special design features further enhance reliability. The Sider's controller is the field-proven, industry standard Xebec SI410A. And Xebec's 3200 drive tester, the

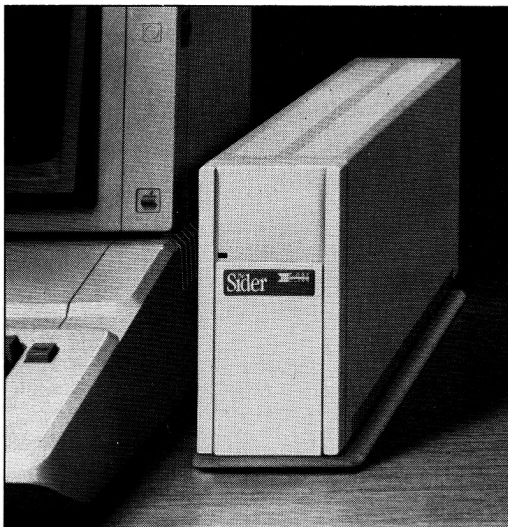

tribution expenses, and pay only for the product.

What about a guarantee?

Like many experienced Apple users, you may be reluctant to buy a hard disk priced at only \$595 without first trying it for yourself how it performs. That's why First Class Peripherals offers you a reassuring, money-back guarantee that eliminates any risk on your part. Simply order the Sider and use it for 15 days. Then, if you're not entirely satisfied, return it and receive a full refund—no questions asked.

The Sider also comes with a full one-year limited warranty. Plus, there's a convenient, toll-free hotline you can call anytime you have a technical or service question, or need help.

Don't delay. Order the Sider now.

To receive the Sider 10 megabyte Winchester hard disk subsystem for only \$595, simply order using the coupon below. For faster service, order by phone and charge to your VISA, MasterCard or American Express. (You can also call us if you have any questions or technical concerns about the Sider. We'll see you get the help you need.) Call toll-free:

1-800-538-1307

In Canada, call 1-800-227-7792

Extension 242

"Only \$595?"

toughest in the industry, ensures that the Sider will operate reliably. One more assurance of the \$595 Sider's quality: it's UL Approved and FCC Class B rated.

But why is it only \$595?

You pay less for the Sider than for other 10 MB hard disks simply because you're paying for the superior quality components inside the unit, not for a lot of retail overhead costs. Since First Class Peripherals sells direct, you avoid dealer and dis-

Yes, please send me the Sider, including half-height 10 megabyte Winchester hard disk drive, Apple adaptor board, cable, complete installation software and documentation.

I prefer to pay as follows:

- I've enclosed my check or money order for \$595* + \$15 shipping and handling, payable to First Class Peripherals.
- Please bill the following credit card account for \$595* + \$15 shipping and handling:
- VISA MasterCard American Express

Card # _____ Exp. Date _____

Signature _____
* Residents of CA, NV and PA, please add appropriate sales tax.

Name _____

Address _____

City _____

State _____ Zip _____

Telephone (area code) _____

Mail to:

FIRST CLASS PERIPHERALS 3579 Highway 50 East
Carson City, NV 89701

Apple and Pro DOS are trademarks of Apple Computer, Inc. CP/M is a registered trademark of Digital Research, Inc.

FROM THE AUTHORS OF
Beneath Apple ProDOS™
NOW THERE'S . . .

Bag of Tricks 2™

By Don Worth and Pieter Lechner

Bag of Tricks 2 does everything the original **Bag of Tricks** did . . .

- **WORKS** with DOS 3.3, DOS 3.2, Pascal, and CP/M diskettes.
- **REPAIRS** damaged diskettes.
- **RECONSTRUCTS** blown catalogs.
- **EXAMINES** and **MODIFIES** disk data.
- **CONTAINS** full documentation, with **TUTORIALS**.

PLUS these **NEW** features:

- Also operates with **ProDOS**.
- Operates with the **PROFILE*** and **SIDER*** hard disks and with the new 3½" **FLOPPY DRIVES** and most **RAM CARDS**.
- **NOT COPY PROTECTED**.
- **ONLY \$49.95** for all four programs, on 5¼" diskette. Requires 64K.

SPECIAL OFFER to **Bag of Tricks** owners:

SAVE \$20 by ordering directly from Quality Software. Send us your original **Bag of Tricks** diskette and \$29.95 plus shipping and handling to order **Bag of Tricks 2**.

ALSO from Quality Software:

Beneath Apple DOS by Worth and Lechner
Covers all facets of DOS 3.3 and previous Apple disk operating systems.
Book. **\$19.95**.

Beneath Apple ProDOS
by Worth and Lechner

They've done it again! This time for ProDOS, Apple's new disk operating system. Book. **\$19.95**

Understanding the Apple II by Jim Sather
Foreword by Steve Wozniak. Covers Apple II and Apple II Plus hardware, including the disk controller. Book. **\$22.95**

Understanding the Appelle by Jim Sather
Similar to Understanding the Apple II, this book covers Apple IIe hardware. **\$24.95**

Universal File Conversion
by Gary Charpentier

Moves files from any standard operating system on the Apple to another. Works with DOS 3.3, CP/M, ProDOS, and Pascal. Unprotected disk. **\$34.95**

QUALITY SOFTWARE

21601 Marilla Street
Chatsworth, California 91311
(818) 709-1721

Ask for Quality Software products at your computer store, or send the price of the software **plus** \$2.50 for shipping and handling (**plus** 6% sales tax if a California resident) to Quality Software. VISA and MasterCard holders may phone their orders.

*Apple and Profile are trademarks of Apple Computer, Inc. Sider is a trademark of First Class Peripherals.

Product Information

Buffer PC board
EPROM burner PC board
Complete buffer kit
Complete EPROM burner kit
Buffer EPROM

Alpha Electronics
P.O. Box 1005
Merritt Island, FL 32952
(305) 453-3534
\$26 (buffer PC board)
\$15 (EPROM burner PC board)
\$139 (complete buffer kit)
\$49 (complete EPROM burner kit)
\$26 (buffer EPROM)

Reader Service Number 322

Copy II Plus

Central Point Software
9700 S.W. Capitol Highway, #100
Portland, OR 97219
(503) 244-5782
\$39.95

Reader Service Number 323

Lifesaver

MicroLab
2310 Skokie Valley Road
Highland Park, IL 60035
(312) 433-7550
\$25

Reader Service Number 324

//c Keypad kit

Southern California Research Group
P.O. Box 593
Moorpark, CA 93020
(800) 635-8310 (CA)
(800) 821-0774
\$29.95

Reader Service Number 325

Ultradisk Test

Computer-Advanced Ideas
1442A Walnut Street
Suite 341
Berkeley, CA 94709
(415) 526-9100
\$29.95

Reader Service Number 326

Now comes the part you don't want to hear. There is no good way to route a 34-wire ribbon cable out of the //c. Perhaps the best way is to cut out several of the separators from the cooling slots in the back, creating a 2-inch horizontal slot through which you can route a cable. It looks as if you can get a cable out near the video-output and external-disk connectors.

Largely because of the difficulties in cable routing, I don't recommend connecting an external keypad to the //c. Neither inCider nor I will bear re-

sponsibility for any negative consequences of your decision to install the adapter.

You could take the keypad adapter a step further and wire it to a 26-pin double-row male jack: The wiring should be identical to that of the //e keyboard connector. The adapter would then let you connect to the //c external keyboards designed for the //e. (Editor's note: The January 1986 issue of inCider featured another approach. See "The Keys to a Better //c" [p. 49].)

One commercial product embeds a numeric-keypad layout into the standard keys of the //c. The Southern California Research Group //c Keypad kit consists of a new keyboard PROM and keypad decals. The Dvorak switch lets you select the numeric-keypad layout. Unfortunately, the //c keyboard ROM is not socketed, so you must desolder the keyboard ROM and install a socket in its place before the Keypad kit PROM.

256K RAM Chips

Can I plug 256K RAM chips into the RAM sockets on my Apple //e motherboard and access 256K of motherboard RAM instead of the standard 64K?

Gino Fortunato
San Mateo, CA

No, you can't. The sockets are wired strictly for 64K chips, and Apple //e memory management supports only 64K of motherboard RAM. The same goes for a standard 64K extended 80-column card. Only auxiliary cards designed to accept 256K chips let you expand memory by installing the bigger chips. The big auxiliary-slot RAM cards (those greater than 64K) have on-board circuitry that divides auxiliary memory into banks of 64K.

A hacker could kludge up a 64K/256K adapter to let you use 256K chips on the motherboard. This should contain extra ICs for bank selection via a jumper to the C07X' signal at auxiliary-slot pin 6, or C10-8 or A10-3,6,11,14. Bank selection should be similar to the RamWorks/MultiRam/Legend E' auxiliary bank-selection protocol: The computer should select motherboard bank zero when you turn it on, and select one of four motherboard banks by storing the bank number at \$C07X. The computer should enable only bank zero during 6502 phase 1, so only motherboard bank zero is used for video-display mapping. ■

What the Experts are Saying About RamWorks II!®

"In an informal competition called '640K vs. 640K' AppleWorks running on a RamWorks equipped Apple IIe outperformed Symphony running on an IBM PC."

—*InfoWorld*

"AppleWorks wiped out Symphony. . . The competition was set up partly to show off another of Wozniak's favorite things, the RamWorks II memory expansion board from Applied Engineering . . ."

—*San Jose Business Journal*

"There are huge differences among the AppleWorks modifying programs sold with the cards. Without doubt, RamWorks II is the most powerful."

—*inCider*

"Applied Engineering's RamWorks is a boon to those who must use large files with AppleWorks. . . I like the product so much that I am buying one for my own system."

—*A+ Magazine*

"RamWorks II is the most powerful auxiliary slot memory card available for your IIe, and I rate it four stars. . . For my money, Applied Engineering's RamWorks II is king of the hill."

—*inCider*



As you can see, it's easy to tell who sets the pace in Apple memory expansion. In fact, if you read the competition's ads, you'll notice that many even claim to be as good as RamWorks. Some say they're "RamWorks compatible".

At least they agree on one thing. RamWorks is the one they have to measure up to. But the truth is there aren't any substitutes for RamWorks.

Because RamWorks and Z-RAM have a mesmerizing list of characteristics that, as you use them, will change your perceptions of an Apple computer forever. Achieving a level of speed and performance most critics claim is the best they've ever seen. But we want to do more than impress the experts, we want to impress you!

Applied Engineering stands ready to solve your expansion needs today and tomorrow with the largest and best supported product line in the industry.

Call Applied Engineering at 214-241-6060, 9 am to 11 pm. To get the very best.

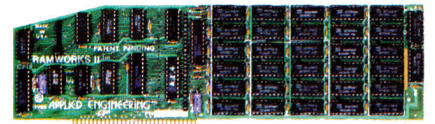

RamWorks II®

The recognized industry standard for memory expansion in the Apple IIe.



214-241-6060

REVIEWS

Instant Pascal, Kid Pro Quo,
Your Personal Financial Planner,
Transet 1000, LiveWire

Pascal for the Masses

INSTANT PASCAL

Apple Computer, 20525 Mariani Avenue,
Cupertino, CA 95014

Programming-language learning aid; Apple IIc,
or IIe with 128K, rev B circuit board,
Extended 80-Column Text Card, and jumper
block; mouse recommended

\$140

| | |
|------------------|---------|
| Ease of learning | ■ ■ ■ ■ |
| Ease of use | ■ ■ ■ ■ |
| Documentation | ■ ■ ■ ■ |
| Support | ■ ■ ■ ■ |
| Overall | ■ ■ ■ ■ |

Computer programming is nothing like it was in the good old days. You used to be able to spot programmers by the beepers hanging from their belts, the printouts stuffed under their arms, and that unmistakable haze in their eyes from long hours spent staring at a terminal. Everyone used assembly language, or BASIC if you were still in grade school.

When Pascal came into vogue, there was still hope for old-fashioned programmers, because the language was difficult to use and even harder to learn. Now Apple has introduced a product that brings Pascal within reach of the average citizen. The programmers of yesterday may soon share the fate of the punchcard.

Not for Hackers Only

Instant Pascal is a new instructional Pascal system designed by the people at Think Technologies, who also developed Macintosh Pascal. In fact, Instant Pascal is virtually identical to its Mac counterpart. Both systems have a multiple-window format (program, text, drawing, and so on) and make heavy use of the mouse.

Even more importantly, though, both systems are interpreted rather than compiled. By nature, Pascal is a compiled language: Before you can run a program, you must first tell the

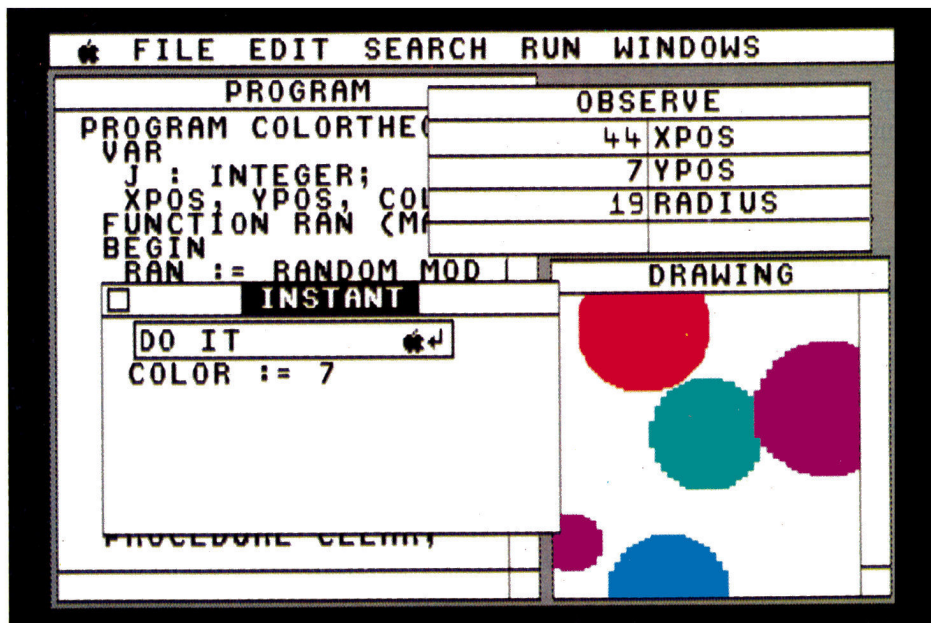

Apple to translate your Pascal code into the machine language computers understand. Unfortunately, even a slight error in syntax will make this compilation run incorrectly or fail altogether. This makes the entire process of learning Pascal difficult and frustrating.

An interpreted language, on the other hand, translates the program as it's running. Although interpreted programs run more slowly than their compiled brethren, they're more flexible and easier to learn. In short, interpreted languages such as Instant Pascal are ideal for instruction.

And for those unfamiliar with mice and windows, the Instant Pascal package includes an excellent tutorial disk, which provides a guided tour of the software's special functions and a brief introduction to Pascal. It's interesting, but the real fun begins when you run the program itself. It's not just for "techies," either—the great joy of Instant Pascal comes from the fact that anyone can use it.

As with Mac software, you perform all Instant Pascal functions within win-

dows and control most of them with a mouse. (Although Instant Pascal will run without one, a mouse lets you work more comfortably.) Each window has a specific use and can be enlarged, reduced, overlapped, moved, or removed. You write the actual Pascal code within the Program window, for instance. A special print feature, which helps locate errors, formats all text you type into this window. The greatest problem most people face in learning Pascal is mastering use of the semicolon, which controls statement separation in the language. Because the special formatter interprets semicolons and arranges program

inCider's Ratings

| | |
|---------------------|---------|
| Excellent | ■ ■ ■ ■ |
| Above average | ■ ■ ■ ■ |
| Good enough | ■ ■ ■ ■ |
| Not up to standards | ■ ■ ■ ■ |
| The empty set | □ |

Mad as HELL at your Apple IIe/c Word Processor-Speller?

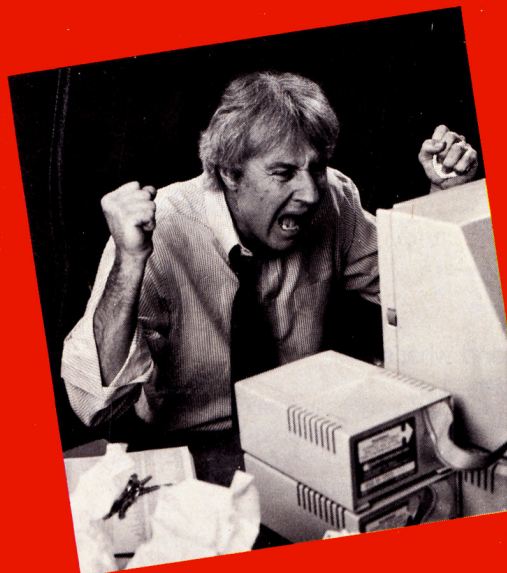

You don't have to take it anymore!

Writing Software International solves your frustrations with other Apple IIe/c Word Processor and Spell Checking systems.

Our Bard's "Pro-Am" Apple IIe/c Writing System consists of 3 Word Processing levels, a built-in 50,000 Word Spell Checker and includes animated graphic tutorials.

All for the tranquilizing price of only \$69.95

(This is less than most spell checkers alone!)

"I struggled with "Applewriter" for quite a while and was continually frustrated by my inability to make it work. I was able to go immediately to your "Professional" program and use it without frustration. I am completely satisfied." **Sheila Stern**, Baldwin, N.Y.

"I congratulate you and your staff for a marvelous program that everyone who owns an Apple (IIe/c) ought to use." **Alex Gonsalves**, San Francisco

**For Immediate Delivery or Further Information
Call Toll FREE 1-800-348-2729 (Ext. 1019)**

**Writing Software
International**

110 E. Broadway • Suite 600
Missoula, Montana 59802
(406) 543-3141



What makes the Bard different?

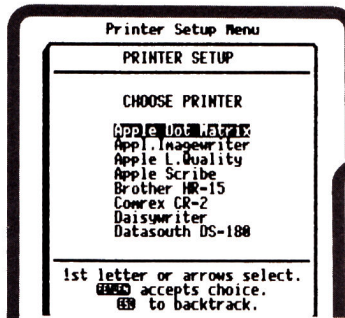

Over 30 popular pre-programmed setups. Select printer, then typeset font features with menu choices.

Preview full pages for layout problems before printing!

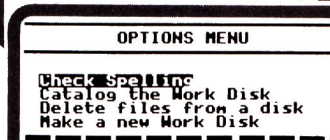

50,000 Word Spell Checking without multiple disk swaps. Add your own words, too!

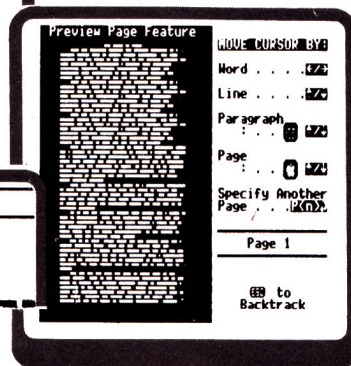

Also, 40/80* column versions, Macros, Cut/Paste, Find/Replace. Illustrated manual.
* Extended 80 column card required. Professional level requires 2 drives.

Writing Software Int. • 110 E. Broadway • Suite 600 • Missoula, MT 59802

Please send me the Bard's "Pro-Am" Apple IIe/c Writing System for \$69.95

(Add \$3.50 for postage and handling.)

Name _____

Address _____

City _____ State _____ Zip _____

Charge my Visa MasterCard American Express

Account # _____ Exp. Date ____/____/____

Amount enclosed \$ _____ Telephone _____

Signature _____

THIRTY DAY MONEY BACK GUARANTEE!

Are you prepared for tomorrow?

inCider knows that your world of computing is as ever-changing as the lifestyles of the '80s. What's "in" today may be "out" tomorrow. And if you're an Apple II* user, not being ready for tomorrow's changes and challenges can mean less productivity and efficiency.

That's why an *inCider* subscription can be the best investment you make for all your tomorrows. The "Apple II Journal" will keep you informed about every current event, as well as ideas that are still on the drawing board.

Yes. I want to be a well-informed Apple II user! Please send me 12 issues of *inCider* for \$24.97. I'll save 30% off the newsstand price.

Payment enclosed Bill me

Name _____

Address _____

City _____ State _____ Zip _____

Canada and Mexico \$27.97, 1 year only, US funds drawn on US bank. Foreign surface \$44.97, 1 year only, US funds drawn on US bank. Foreign airmail, please inquire. Please allow 6-8 weeks for delivery.

**inCider, P.O. Box 911, Farmingdale,
NY 11737** 364B5

Stay On Top Of The Trends

And to know what's hot and what's not, you need to **Ask *inCider***—the popular monthly feature that answers your questions about the latest software and the newest programming ideas.

Hardware? In **Apple Clinic**, you'll learn what works best for other Apple users, plus you'll discover some very economical maintenance and repair hints.

Then, take a look at **Applesoft Adviser**. In no time, you'll become a natural with BASIC so that you can be a better and more creative programmer.

And that's just the beginning of what's in every *inCider* every month.

The Progressive "Apple II Journal"

inCider is today's Apple II magazine dedicated to meeting the challenges you'll face tomorrow. Even our new look sports a cleaner, more appealing design for easier reading and reference!

Subscribe now and you'll get 12 issues of *inCider* for just \$24.97—a **30% savings** off the cover price! To order, just return the coupon, or call **1-800-258-5473**. (In NH, call 1-924-9471.)

* Apple II is a registered trademark of Apple Computer, Inc.



inCider

Showing you the future that's taking shape today.

code to reflect their (apparent) meaning, it's easy to see when something's wrong.

Most program output is then routed to either the Text or the Drawing window (depending on the type of program you've written). Both windows may operate during a single program run, and you can size them according to need. You can also direct output to text or random-access files, or even a speaker.

Two auxiliary windows help you debug your programs. The first is the Instant window, similar to the Program window in that it accepts Pascal code. The Instant window lets you execute individual statements without requiring an entire program as superstructure. This is useful if you want to see the effect of a statement before placing it in your program.

Once the program is running, the Observe window displays the current values of the variables you request.

A Flexible Tool for Learning

These fancy manipulations are possible because Instant Pascal is interpreted, rather than compiled. Interpreted languages execute program statements one at a time. Although they're slower than compiled languages, which translate the program as a whole, interpreted languages are more flexible. For instance, Instant Pascal lets you halt a program halfway through, examine some variables, then restart it.

All these goodies are simply add-on functions that don't change the inherent structure of the language, however. Despite the additions, Instant Pascal conforms to most of the rules set for standard Pascal. The only exception is that Instant Pascal doesn't support pointers, an advanced feature of Pascal. Because pointers are complex and confusing, they're often omitted from introductory material on Pascal. But pointers are an integral part of the language, and as long as Apple has provided such an excellent learning environment, it should allow for learning pointers as well.

Accompanying this impressive software is an equally impressive book. And it is a book, not simply "documentation" or a reference. It's similar to a number of "How to Program in Pascal" books on the market, but it's much easier to understand than most of these others, which read like doctoral dissertations run amok. This Pascal book is written for the beginner, and is meant to be a self-teaching guide.

Even compared to the best texts, the Instant Pascal book still has an advantage because it's matched exactly with the software. Much of the instruction is in the form of "hands-on" exercises that ask you to put down the book and boot up the system. In short, it's just a well-written, well-designed work, right down to its spiral binding, so you don't have to wedge it under your machine to use both simultaneously. And for quick reference, there's a separate pocket guide to most of Instant Pascal's features.

Whether or not you should spend the money on Instant Pascal depends on your needs. It's certainly the best instructive Pascal system, but it's not the only one. For instance, Visible Pascal (reviewed in the December 1985 *inCider*, p. 118) is less expensive, but more difficult. You could also just buy a tutorial book. Whatever your choice, remember that Instant Pascal is simply a learning aid—to do any real Pascal programming, you'll eventually have to buy a compiler. ■

James McKelvey
London, England



The Creative Edge

KID PRO QUO

Softsync, 162 Madison Avenue,
New York, NY 10016

Multifunction word processor; Apple IIe, IIc,
or II Plus with 64K
\$39.95

| | |
|---------------|-----------|
| Ease of setup | ■ ■ |
| Ease of use | ■ ■ ■ |
| Documentation | ■ ■ ■ ■ |
| Support | ■ ■ ■ ■ |
| Overall | ■ ■ ■ ■ ■ |

A play on the Latin phrase *quid pro quo* (what you put in is what you

get back), Kid Pro Quo coaxes a budding young raconteur's talents to the fore. This multifunction word-processing program adds color, sound, graphics, and animation to the storytelling process, and receives high marks as a tool to promote creativity in kids—and even in grown-ups.

The program's three input modes—write, draw, and compose, for creating text, illustrating it, and setting it to music—cast you as writer, director, and producer of a small-scale audio-visual presentation. You can create your own drawings and music or use shapes and tunes contained in the library on the back of the program disk, and you can animate either stock illustrations or original designs. Although you can execute commands from the keyboard and produce crude sketches by manipulating the cursor in standard directions, Softsync strongly suggests you use a joystick, mouse, or Koala-Pad with the program to speed up drawing and selecting commands.

Getting Started

When you first boot Kid Pro Quo, you can change the set-up specifications, but the program then defaults to draw mode. This is a peculiarity of Kid Pro Quo, because draw is not the place to start. Instead, you must first create work space in the file mode. You can select the NEW PAGE command to open a blank "book," or you can load an existing file into the computer.

If you overlook this important first step, you can save your work in the default file called "Kid Pro Quo." This is not advisable, however, if you plan to transfer the page to a new location, because Kid Pro Quo lets you load or transfer a page only in piecemeal fashion. Thus, you must load and move music, shapes, and text individually—a clumsy procedure at best.

The Modes

Once you have prepared a new page, you are free to write, draw, or compose in any order. A good place to start is with the creation of text, in either write or draw mode. Write mode is preferable for long entries because it provides standard word-processing features such as word wrap and insert. If you begin in draw mode, your illustrations will temporarily disappear from the screen when you move to write mode, but will reappear when you return to draw mode or when you play the book you created.

Draw mode has nine subset commands represented by icons in a special pop-on menu: animate, pick-up, copy, magnify, sketch, delete, inverse, rotate, and flip. Sketch lets you create original pictures with six crayon colors—green, orange, violet, navy, white, and black. When you choose this option, the screen opens up to create a blackboard with a new set of icons to the left. Besides the crayons, other icons include arrows to expand the blackboard, an eye to see a minia-

turized version of the design, a Yin-Yang and an apple to change the screen back and forth from black-and-white to color, and a hand to bring the design back to the main screen.

Once you have pulled the design to the main screen, you can move it into place with the magnet icon, copy it with the camera icon, or delete it with the trash can. A mirror icon flips a shape on its side, the spiral rotates it, the mask creates an inverse of the

shape, and the magnifying glass enlarges it.

With the movie-camera icon, you can create animation with up to 96 steps per page. By a somewhat complicated process of clicking, moving, and erasing, you can move a shape across the screen or create the effect of a bouncing ball, and you can even set the action to music. The animation will show up when you play back the page or book.

Composing is a relatively simple process with Kid Pro Quo. A five-line musical staff appears on screen with a menu of musical symbols and notes. You can create melodies of up to 250 notes per page in either treble or bass clef. If you want to coordinate music and animation, you must place a "go" symbol on the staff for every movement. So, if a rabbit hops across the screen in ten steps, ten go symbols must accompany the music to synchronize the rabbit's movements with the sound. Otherwise, Kid Pro Quo plays the music first, then the animation.

The library on the back of the program disk contains six melodies you can use in lieu of original compositions. The tunes are *Jingle Bells*, *Frère Jacques*, *This Old Man*, *Yankee Doodle*, *Happy Birthday*, and *Dixie*. The library also contains almost 100 choices of shapes, including air-planes, boats, trees, automobiles, toys, buildings, animals, icons, electronics symbols, and flowcharts. In addition, you can use six text fonts to vary the appearance of a page.

The Good and the Bad

Kid Pro Quo has a number of redeeming qualities, chief of which is its multimedia approach to the storytelling process. A tale comes alive for a young person when sound, color, and animation are added to the text.

But if this word processor is innovative, it is also cumbersome. You must treat each page of a book as a separate file, for example, and save it after you've used up the available display space. (For straight text, the display area amounts to 22 lines of 40 characters each.) To continue the story, you must open a new page by going back to file mode. And, as mentioned earlier, you cannot load a page as is, but must do it piece by piece, handling music, shapes, and text separately.

I found it difficult to create original designs. I would barely touch my KoalaPad, and the design would sprawl across the page. Moreover,

MouseWrite™
The Mouse-Based Word Processor
For the Apple IIe and IIc

MouseWrite: File Edit Find Move Style Page Windows Help
Open Second Window Cut
Close
Page
Page #2
Print Documents
Quit

Dear Matt,
Just a quick note to say thanks for all your help in selecting a new word processor. Frankly, Matt, the one you recommended was just too complicated for me. I got to this time to learn that you got me a whole lot better dealer should be a package called MouseWrite from Roger Wagner Publishing. It does everything yours does and more, plus it operates just like a Macintosh! A desktop, pull down menus, multiple windows, dialog boxes, and it even has its own clock. Everything I need is on the screen and the mouse does it. Use what you want and at the choice, and the words are just on the screen.

Available At Dealers Now.
Suggested Retail: \$125.00
Ask your dealer for a MouseWrite demonstration, or send \$3.00 to Roger Wagner Publishing for your own MouseWrite Demo diskette.

Roger Wagner™
PUBLISHING, INC.

10761 Woodside Avenue • Suite E • P.O. Box 582 • Santee, CA 92071 • 619/562-3670

To boldly go at speeds no Apple has gone before.

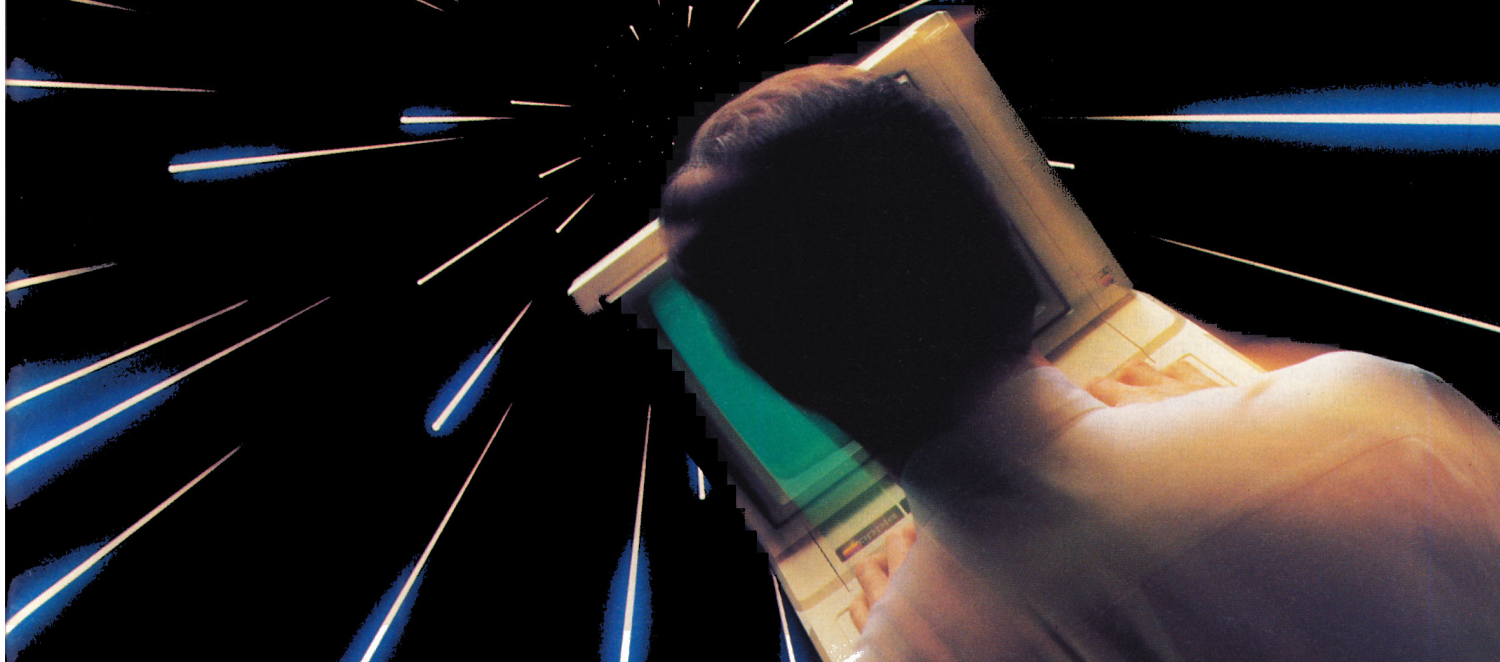

Get TransWarp™. The fastest accelerator you can buy for your Apple™ IIe, II, or II+.

Computing at warp speed!

It's an experience you shouldn't miss. And with TransWarp, you won't have to. Because TransWarp will run your software up to 3.6 times faster — leaving other accelerators in the stardust!

No more yawning while your Apple™ slowly rearranges text or calculates spreadsheets. With 256K of ultra-fast RAM, TransWarp speeds up *all* Apple software — including AppleWorks, SuperCalc 3a, Visicalc, and all educational software, graphics and games. And it's compatible with all standard peripheral cards (such as RamWorks II and Apple memory cards), Profile and Sider hard disks, 3½" UniDisks, 80-column cards, modems, clock cards, mouses and more! You name it, TransWarp accelerates it. There's even a 16 bit upgrade chip available should 16 bit software become available for the Apple.



"I recommend Applied Engineering products wholeheartedly."

*Steve Wozniak, the creator
of Apple Computer*

An important difference.

TransWarp's not the only speedup card on the market. But it's the only one that accelerates your Apple's main memory, ROM and auxiliary memory. And with more and more programs residing in auxiliary memory, buying anyone else's accelerator makes less and less sense. TransWarp even works with most D.M.A. devices including the Swyft™ card.

There's one more difference. Since TransWarp doesn't use memory caching, it accelerates *all* software — and not just most of it.

A cinch to use.

Simply plug TransWarp into any slot in your Apple II, II+ or IIe — including slot 3 in the IIe. Instantly you'll be computing at speeds you only dreamed about before. And should you ever wish

to run at normal speed, simply press the ESC key while turning your Apple on.

Since TransWarp is completely transparent, you won't need pre-boot disks or special software. It's ready to go right out of the package!

Speed = Productivity

Imagine the productivity gains you'll achieve when your programs are running over three times faster. TransWarp is so powerful, your Apple will make IBM PCs™ and even ATs™ look like slowpokes — whether you're planning taxes, plotting charts or playing games! Take a look at a few of the features that set TransWarp apart:

- 3.6 MHZ 65C02
- 256K of ultra-fast on-board RAM
- Accelerates main *and* auxiliary memory
- Low power consumption for cool operation
- Totally transparent operation with all software
- Plugs into any slot, including slot 3 on the Apple IIe
- Accelerated 16 bit option available

Satisfaction guaranteed!

Give *your* Apple the TransWarp advantage. With our risk-free 15-day money back guarantee, you have nothing to lose but wasted time. Call today!

TransWarp Accelerator \$279
16 bit upgrade (may add later) \$89

For fast response:

Call Applied Engineering, 9 a.m. to 11 p.m., 7 days at (214) 241-6060. MasterCard, VISA and C.O.D. welcome. Texas residents add 5½% sales tax. Add \$10.00 if outside U.S.A.

Or mail check or money order to Applied Engineering, P. O. Box 798, Carrollton, TX 75006.

AE Applied Engineering
The Apple enhancement experts.

P. O. Box 798, Carrollton, TX 75006 (214) 241-6060

the sketch lines were thick and bulky and could move only up, down, left, or right, instead of in circles.

Creating music was a laborious process because the notes were hard to control and put into place. A note I tried to put on the treble clef as an F, for example, slid up and down to E and G before I could click it into place. I would have preferred a keyboard-entry method to quickly duplicate tunes I wanted to play.

Perhaps the most glaring deficiency of Kid Pro Quo is its lack of proper documentation. The manual contains no sequential instructions that tell the new user how to create his or her first book. There are also annoying and confusing statements in the *Kid Pro Quo Companion*: It says to "load shapes and music from the library to any place you choose," but omits explaining how. If you go to file mode and load shapes or music from the library,

however, nothing changes on screen—you still see the file menu. It isn't until you go to draw or compose that you realize you've been successful.

I employed a teenager of average intelligence and minimal computer literacy to test Kid Pro Quo's ease of use. One hour later, he still had not figured out how to complete a book using all of the program's features. This is not an encouraging statement about the documentation, since Kid Pro Quo is supposed to be for grade-school children and teenagers.

In summary, this word processor brings some fresh ideas to the writing arena, but it lacks refinement and proper instructional materials. A re-vamping of the documentation would yield a dramatic improvement in its ease of use. Despite its problems, Kid Pro Quo is a lot of fun. ■

Wendy Lea McKibbin
inCider staff

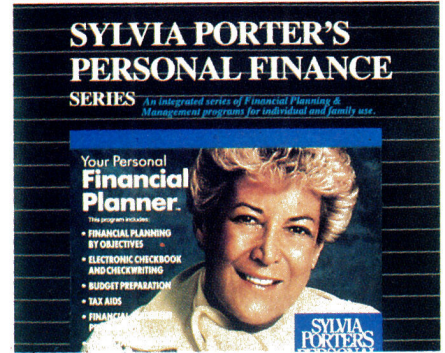

The Master Plan YOUR PERSONAL FINANCIAL PLANNER

Timeworks, 444 Lake Cook Road,
Deerfield, IL 60015

Personal-finance software; Apple IIc or
extended-memory IIe, DOS 3.3
\$99.95

| | |
|------------------|---------|
| Ease of learning | ■ ■ ■ ■ |
| Ease of use | ■ ■ ■ ■ |
| Documentation | ■ ■ ■ ■ |
| Support | ■ ■ ■ ■ |
| Overall | ■ ■ ■ ■ |

Imagine Sylvia Porter stowed away in your disk file. In a sense, that's what Your Personal Financial Planner (volume 1 of Sylvia Porter's Personal Finance Series) brings you—Sylvia Porter cloned on floppy disks. As soon as you open the user's manual, you'll recognize the financial guru's friendly, personal style.

An encouraging mentor, she writes in the foreword, "Until this moment you may have thought that you could not possibly do your own financial planning, that it was too complex and that you lacked the necessary knowledge or expertise. Nonsense. You supply the incentive, and this program will supply the means."

No if's, and's, or but's, and no inflated claims—two double-sided floppies contain the modules that let you take full advantage of the program's wide-ranging features.

Your Personal Financial Planner isn't just for balancing checkbooks. It's your financial partner every step of the way—from working out a budget to planning for major investments, like a college education or purchasing a home. And when the time comes to visit your friendly neighborhood banker for a loan, Your Personal Financial Planner will print professional-

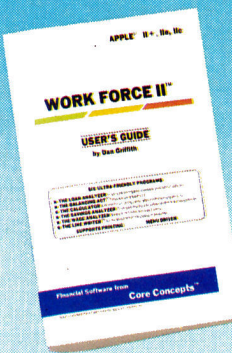

WORK FORCE II™

"A Valuable, Indispensable Tool..."

Business Section, The San Francisco Independent

Six Financial & Productivity Programs on one disk. Menu driven, ultra friendly, powerful. Compatible with the **IBM PC, XT, AT, jr, true Compatibles**, and the **Apple IIc, IIe, II+, II.**

THE LOAN ANALYZER: Display or print loan amortizations starting or stopping at any period. Begin loans in mid-year. Work Force II is used by banks, CPA's, and real estate professionals across America. Work Force II will find:

- Balloon Payments
- Yearly Total Interest
- Unknown term
- Payment Amount
- Negative Amortization
- Total Interest & Payments
- Amount which can be Financed
- Present Value of Capital Leases

THE LINE WRITER™: Line-at-a-time correctable typewriter. Makes envelopes, forms, memos, and labels a snap. Faster and easier to use than your word processor.

THE BALANCING ACT™: Unique checkbook balancing system. No need to enter every check & deposit. Change entries, add entries, or print entries. A few minutes each month does it all.

Full Function Printing Calculator — Wage & Income Analysis
Future Value of Savings, Investments, IRA's

Greg Glau, inCider "Borrowing money is no problem with the loan analysis section to guide you. Work Force II is easy to understand and operate. It's an honest value..."

Les Schmeltz, MICRO-TIMES: "WORK FORCE II may be one of the best bargains around."

Call Toll Free
ORDERS ONLY
1-800-525-CORE

Rush me WORK FORCE II for the Apple at \$39.95

Rush me WORK FORCE II for the IBM at \$47.95 (prices include shipping)

check or money order VISA MC AE COD (add \$4.00 for COD)

Arizona residents add 6.5% Sales Tax. Overseas add \$5.00

Card # _____

Signature _____ Valid From _____ to _____

Name _____ Phone _____

Address _____

City/State/Zip _____

Apple is registered trademark of Apple Computer. IBM is a registered trademark of International Business Machine

Core Concepts
P.O. Box 24157 Tempe, AZ 85282
AZ residents & inquiries call (602) 968-3755



TEMPLE OF APSHAI TRILOGY™ BIGGER. MEANER. AND RICHER THAN EVER.

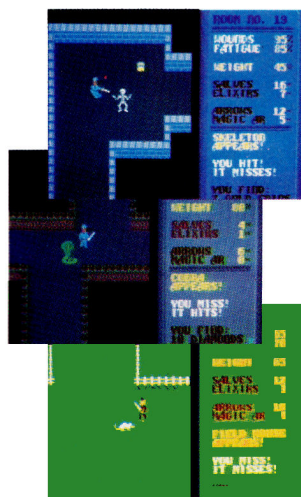

You know Temple of Apshai. The classic. Best-seller for over *four years*. You may have friends trapped forever in its dark recesses. Players have dropped from sight for weeks at a time, searching for the treasures of Apshai.

Well now we've raised the stakes. Introducing the *new* Apshai Trilogy. The *combined* wrath of the world famous Temple of Apshai®, Upper Reaches of Apshai®, and Curse of Ra®. All on a single disk. Twelve levels. 568 rooms to explore. More choices. More chances. Best of all, there's faster game play.

The graphics and sounds are new. The challenge of the dungeons is timeless. Are you ready for the most involving role-playing game ever designed? Temple of Apshai is waiting. Silently lurking. Patiently waiting. *For you*. At your nearest Epyx dealer.

| | APPLE | MAC | ATARI | ATARI ST | IBM PC | CGM/286 | AMIGA |
|--------------------------|-------|-----|-------|----------|--------|---------|-------|
| Temple of Apshai Trilogy | ✓ | ✓ | ✓ | ✓ | ✓ | ✓ | ✓ |

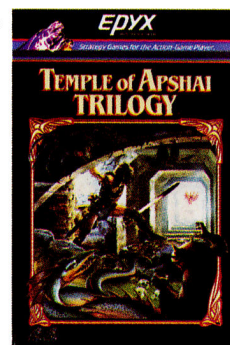

 **EPYX**
COMPUTER SOFTWARE
1043 Kiel Court, Sunnyvale, CA 94089

looking income and net-worth statements, too.

Customized Accounting and Budgeting

Your Personal Financial Planner's main program takes you to any of six modules—Transaction Manager, Budget Manager, Asset/Liability Manager, Income and Expense Statement, Balance Sheet, and Financial Planner.

The Transaction Manager is your personal accountant. You type your income and expenses into any of approximately 140 categories. (Time-works apparently hasn't overlooked any details. Even cable TV and pet expenses have their own categories.) Like professional accounting programs, each category in Sylvia Porter's has its own identification number. There are enough "open" categories for you to customize the program or tag tax-deductible expenses.

For any bill you pay, you can distribute the expense to as many as six different categories. You may have paid for your latest shopping spree at

Sears with one check, but purchases may have included jeans for your son (#0703, Clothing), new blades for your circular saw (#0502, Residence), and a VCR for the family (#1002, Entertainment).

Your Personal Financial Planner can handle up to 900 transactions on one data disk. Up to 24 of them can be automatic. If your health club collects membership fees each month through an electronic funds-transfer arrangement with your bank, you type this information into Your Personal Financial Planner only once, and the program automatically accounts for the payment each month.

The program helps you keep track of up to ten credit cards and five checking accounts. Using tractor-fed forms from NEBS, a business and computer stationery supplier, Your Personal Financial Planner prints checks and stubs and maintains a check register.

The Budget Manager, like the Transaction Manager, consists of pre-programmed, but modifiable, cate-

gories and subcategories. You type in budget amounts for any or all months of the year for any categories that apply to your lifestyle. The program automatically compares budgeted amounts to actual amounts by month or by category. Your progress is colorfully charted in bar graphs or cross-referenced charts (which look like horizontal bar graphs). Unfortunately, you can't print any graphs.

The Asset/Liability Manager keeps account of your growing financial resources and debts. When you purchase stock in a company or buy a certificate of deposit at your bank, type the information into an asset category with the corresponding identifying number (for example, #2004, Certificates of Deposit). Like the Transaction Manager and the Budget Manager, category numbers used by the Asset/Liability Manager are in the manual.

All three "managers" work together, so when you increase an asset or decrease a liability (such as making a mortgage payment), Your Personal Fi-

COLOSSUS is the most complete chess program available for the **CBM™ 64/128** and **APPLE™ 2 Series**, written using the very latest techniques by a computer chess programmer of eight years experience. It has the widest range of true features available, including some never before implemented on *any* home computer chess program.

COLOSSUS has a perfect understanding of *all* the rules of chess, including under-promotions, the fifty move rule and all draws by repetition. It can handle standard mates; including the very difficult King, Bishop and Knight versus King.

COLOSSUS also offers the choice between the usual two dimensional flat board display or the new three dimensional real life board which allied to optional joystick control makes it clear and easy to use. It comes with a comprehensive instruction manual and is easily the best chess program for casual and serious players alike.



FACTSHEET/ORDER HOTLINE: 201.934.7373

FIREBIRD LICENSEES INC. 74 NORTH CENTRAL AVENUE RAMSEY NEW JERSEY 07446

(201).934.7373

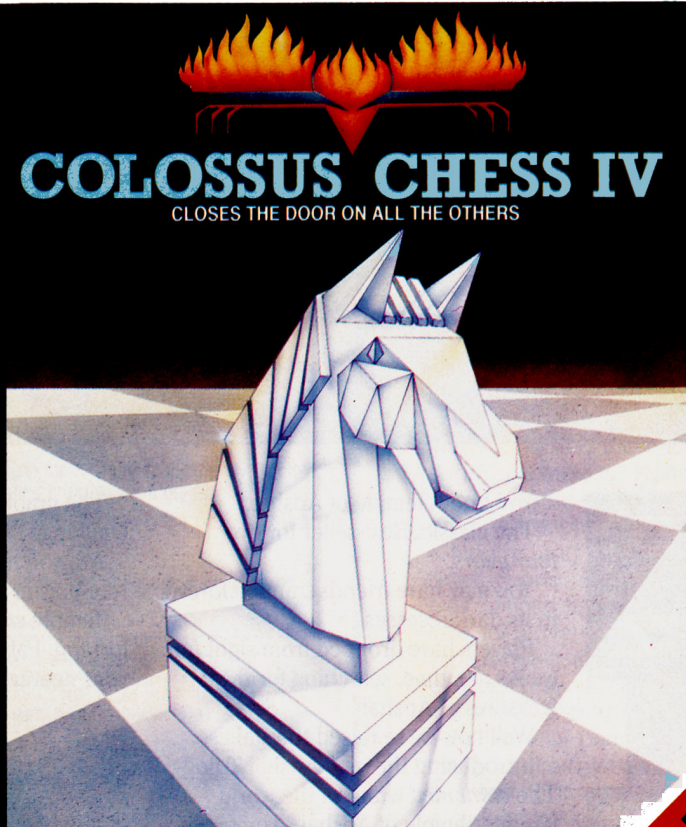

**APPLE 2 Series
CBM 64/128**

Financial Planner automatically computes the results.

The Financial Planner lets you play "what if" with your financial future. Preprogrammed worksheets let you easily determine how much money you need to pay for college or a new home, to start your own business, or to ensure a comfortable retirement. A fifth worksheet, called "Other," lets you tailor financial-planning mathematics to your dreams of a sailboat or vacation.

A separate Insurance Worksheet holds information about your policies, and a Family Information section stores names, birthdays, and Social Security numbers.

A program like Your Personal Financial Planner offers so many features, it would be easy to lose sight of your overall financial picture, were it not for one all-encompassing function. The program takes all the information you patiently entered—your family size, income and expenses, budgetary goals, assets and liabilities, and dreams—and organizes it into a professional, ten-page Personal Financial Plan.

This document, suitable for discussion with your banker or spouse, is complete with title page, table of contents, and a complete profile of your current status, your objectives, and the steps necessary to reach your financial goals. The report is dated and pages are numbered.

Comments Pro and Con

Your Personal Financial Planner offers a couple of desktop accessories—a memo pad and calculator—you might find useful as you chart the course of your financial future. Program messages are informative and polite. All module offerings look like Macintosh menu bars. You select each menu and pull it down via the arrow and return keys, and on-screen prompting and dialogue boxes are available.

While the program is thorough and easy to use, the disk swapping involved is sometimes annoying. Each Manager requires a separate data disk. Together with the other four sides, that's seven disk sides. Even with two drives, you may sometimes become impatient.

Another annoyance is the time required for some modules to load. I

tend to become fidgety if loading isn't complete in less than ten seconds. My impatience would be nullified somewhat if the program could be installed on a hard disk. Unfortunately, program disk Side 1 is copy-protected. I queried Timeworks about the possibility of offering the complete program in 3½-inch format; the company is taking a "wait and see" attitude, pending Apple users' acceptance of the UniDisk 3.5 drive.

Despite annoying disk swaps and wait times, the program is well worth its price. It's doubtful that even an in-the-flesh financial adviser could do so much for so little. ■

Cynthia E. Field
Wakefield, RI

Editor's note: Jessica Chipkin of Timeworks reports that the company is considering producing a copyable version of Your Personal Financial Planner, in addition to the 3½-inch format.

RESCUE RAIDERS

THE FINAL WAR

The date is 1944, a week after D-day. The place is Cherbourg, France, a few miles from the Normandy beaches. The commotion is Rescue Raiders, an amazing new game that combines fast arcade action with strategy and tactics.

As commander of the Allied forces, you must marshal troops, deploy weapons and mastermind a military campaign.

RESCUE RAIDERS has the subtle Sir-tech touches that keep you coming back for more. Vehicles, aircraft and missiles move realistically and conform to the laws of physics. And the computer-command enemy is intelligent . . . and cunning. Quick reflexes are important and so is the ability to plan long-range strategies.

Every battle you fight, every time you play this epic is refreshingly new and different. And, win or lose, you'll get a history lesson.

SIR-TECH
SOFTWARE INC.

6 MAIN STREET
OGDENSBURG, N.Y. 13669
315-393-6633

Works on Apple II series. 64K joystick required.

COMPUTOUGH

"Anyone who wants to win MegaWars has to dominate entire planetary systems. And me."

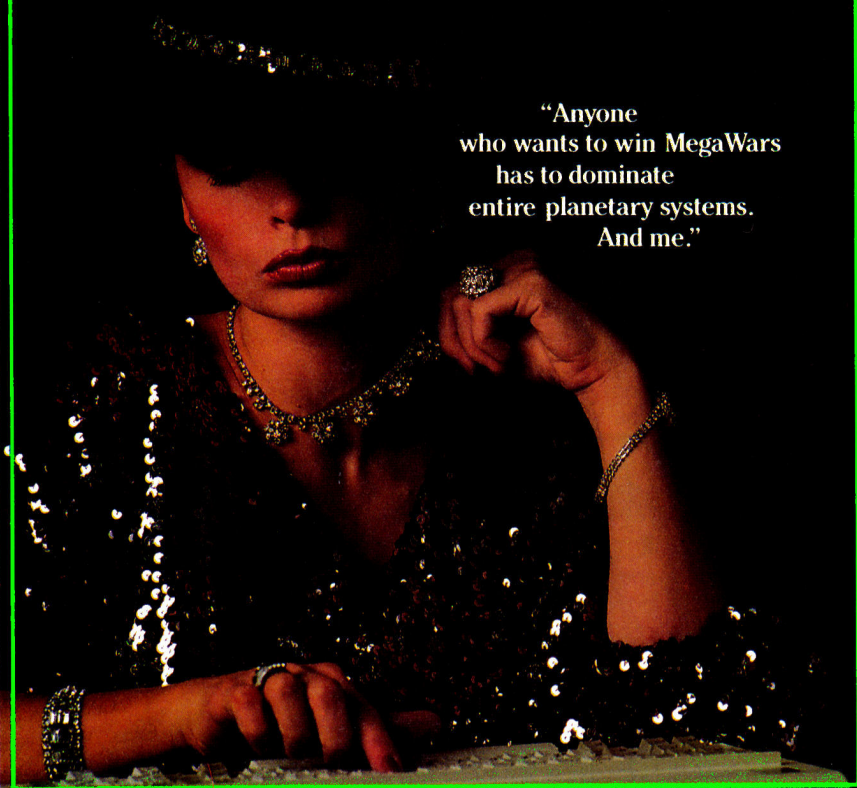

COMPUFUN

"'You Gussed It!?' It's just like a TV game show. Answer questions—win prizes. And I can play right here in the living room!"



Easy Communications

TRANSET 1000

Hayes Microcomputer Products,
705 Westech Drive, Norcross, GA 30092
Communications buffering system; any Apple II
\$399

- Ease of setup ■
- Ease of use ■■
- Documentation ■■■
- Support ■■
- Overall ■■■

A long time ago, someone said, "Give me a fulcrum, a long enough lever, and a place to stand, and I can move the world." The Hayes Transet 1000 is certainly worthy of earth-moving attention, but it might be on shaky footing with Apple owners.

The Transet is a total communications buffering system, with 128K of RAM, 32K of ROM, and a 68008 microprocessor. It comes with two bidirectional serial ports and a parallel/serial port for output only. You can use it to link two computers to a single printer (and queue your printing when either computer tries to access the printer while the other is using it). It makes communication between two computers a snap, and, connected to a modem, it can act as a mini-bulletin board/mail system with your computer turned off. To maximize the effectiveness of its 128K memory, it uses an algorithm that compresses information into the buffer and decodes it during output. Obviously, we're talking major-league hardware here.

My Transet arrived with IBM PC-AT-compatible connecting cables and installation software. It was obviously a shipping error, so I called the Hayes service people. They were quite willing to send the correct cables for ei-

ther my //e or //c, but the software was another matter. There isn't any installation software for the Apple. It's not that the Apple doesn't need the software, there just isn't any.

Configuring the Transet involves the possible setting of 31 general-purpose commands, 27 document-formatting commands, 24 mailbox commands, 34 communications commands, and 29 system commands. Not that anyone would need to set them all at once, but 145 command possibilities can become a bit involved. I'm flattered by Hayes' estimation of my Apple-bred ability to forge ahead despite obstacles. Eventually, I'll write my own installation software for the Transet, but I'd rather have it now—weekends tend to be a bit hectic.

The Transet Message Center

Incredibly, that's the only thing I've found wrong with the Transet. It's phenomenal. Its memory is divided into three partitions: the Immediate, Replay, and Mailbox buffers. Data entering the Transet are passed through the Immediate buffer to their destination—whether it's a printer, computer, or modem. Then the information is stored in the Replay buffer in case you need to send copies of the document to another device. If you want, you can lock information into the Replay buffer so that new data don't erase it.

The Mailbox buffer stores incoming messages from your modem, formatting them with the sender's name, the topic, and the message itself (it asks for that information when someone dials in). You can read messages back or scan through them by topic. To receive a message, only the Transet and the modem need to be turned on—you can leave your computer off. If you've connected a printer to the Transet and leave it on, you can instruct it to print the oldest message in the system and continue recording new arrivals, should the Mailbox buffer become filled. And you can password-control the Mailbox for security.

If you don't have a full-function word processor, you can define the page set-up parameters for Transet's printed output, including page numbering and a date/time stamp. There's a built-in, lithium-battery-powered clock that can save you a slot in your Apple (though software will be needed to read the Apple's serial port to determine the time or date—see Editor's note below). Of course, you could

inCider

COMPU CRAZY

"Ready for an adventurous challenge?
We're a team. And Nellie
doesn't horse around."



COMPU SERVE GAMES

You never know
who you'll be up against
when you go online
with CompuServe.

To buy your CompuServe Subscription Kit,
see your nearest computer dealer.
Suggested retail price \$39.95.

To request our free brochure or order direct,
call or write: **800-848-8199**
(In Ohio, call 614-457-0802)

CompuServe®

5000 Arlington Centre Blvd.
Columbus, OH 43220

use these features for raw data you receive from your modem.

You can also send all the command parameters you've issued to nonvolatile memory, so you won't need to reenter them each time you power up the Transet. Nonvolatile-memory devices like EEPROMs (electrically erasable programmable read-only memory) have a limited lifespan when they're continually erased and rewritten. Given the average number of times you might change the Transet's working parame-

ters and write them to nonvolatile memory, the EEPROM will have quite a long life. (Were I to make "permanent" changes every day for a few months, I'd soon need a new EEPROM.)

The Transet manual is one of the most intense, yet easily decipherable, pieces of computer literature I've yet seen (aside from the original Apple manuals by Raskin). Fifteen pages are dedicated to describing the correct cable configurations for various computers and peripherals.

Installing the Transet in a multiple-computer setting is as close as you can come to network capabilities without physically putting in a network. With a modem, it makes an excellent light-load message center. Add a printer to that and you can create a full-fledged message center without a computer at all. And with two printers, the Transet can simultaneously print to both of them (because of its buffering capability), doubling your rate of printed output. I use accolades sparingly these days, but even considering the lack of appropriate installation software, the Transet may well be one of the most significant Apple add-ons of the year. ■

Bill O'Brien
Fort Lee, NJ

Editor's note: At press time, Daniel Reardon of Hayes promised to deliver "installation software for the Apple //c and enhanced //e, which will support the built-in clock" by March 1986. Readers are also reminded that configuration software for the Macintosh is available.

**WITH THIS ONE PROGRAM
YOU CAN EASILY
DESIGN,
ORGANIZE,
FILE,
SEARCH,
SORT,
CALCULATE,
MERGE,
AND PRINT
USING FLOPPY OR
HARD DISK.**



**AppleWorks
Compatible**

ALL FOR ONLY \$99.95

PROFILER 2.1 - A SINGLE-DISK DATA MANAGER/REPORT GENERATOR

With ProFILER 2.1 you get power, flexibility, and ease of use all on one floppy disk. And you can easily transfer all your data to hard disk without additional data entry. To get a whole lot more out of your Apple - for a whole lot less - order today.

- File and report on one floppy disk
- Store up to 1500 records per floppy or 65,000 per hard disk
- Multiple files per disk, multiple index files, full screen editor
- Menu-driven for help at every step - create forms in minutes
- ProDOS operating system generates reports eight times faster than DOS 3.3
- Reads AppleWorks data base files
- Supports memory expansion and accelerator cards

PFS Users - Ask about our optional Data Conversion Program.



Software

17610 Beach Blvd. Suite 29
P.O. Box 1788
Huntington Beach, CA 92647
714-963-2221 • 714-841-7400

See your dealer or order today!

1-800-628-2828 Ext. 530

Plus \$3.00 shipping. CA res. add \$6.00 sales tax.



A World of Printers

LIVEWIRE

Street Electronics, 1140 Mark Avenue,
Carpinteria, CA 93013

Serial-to-parallel converter; Apple //c
\$99.95

| | |
|---------------|---------|
| Ease of setup | ■ ■ ■ ■ |
| Ease of use | ■ ■ ■ ■ |
| Documentation | ■ ■ ■ ■ |
| Support | ■ ■ ■ ■ |
| Overall | ■ ■ ■ ■ |

Attention, Apple //c owners! Do you envy your friends who own Apple

//e's because they seem to have an unlimited choice of dot-matrix printers? With nary a care, it seems, they can plug serial or parallel interfaces into slot 1, while you cannot. Take heart. Street Electronics has come up with a way around the problem.

LiveWire is a compact device that translates the serial output from the Apple //c's printer port into a form acceptable to dot-matrix printers that usually require a standard Centronics-type parallel interface. With the LiveWire hardware and software, you can smoothly use many popular, low-cost printers, such as those Epson and Okidata manufacture.

LiveWire gives Apple //c owners the option of purchasing a parallel printer instead of a serial one. And in addition to the converter, you also receive a clock/calendar and a versatile screen-dump program.

Hardware

The Apple-beige LiveWire hardware consists of a 6-foot round cable with a connector at each end. The serial connector at one end plugs directly into the printer port on the back of the //c. The parallel connector at the other end mates with, and is held securely in place by, the input port and V-shaped clips on the printer. A converter box, which is a little smaller than a pack of regular cigarettes, is located near the "parallel" end, between the printer and the //c.

In addition to the serial/parallel converter inside the box, LiveWire has a built-in clock/calendar, which runs on the power supplied by a nearly 1-inch diameter, 3V lithium battery. The manufacturer claims the battery will last more than a year. Street Electronics will sell you a replacement battery for \$5, or you can use Panasonic, Eveready, or Radio Shack batteries.

Software

The software accompanying the LiveWire hardware comes in the form of a copyable utility-program disk (version 1.0). Mimicking the Macintosh desktop, this disk offers a menu bar and menus you can select and pull down with a mouse or with the arrow and escape keys. The Apple, File, Format, Size, Style, Graphics, and Clock menus offer you the various LiveWire utilities options.

The Apple menu contains the standard information about software version number, copyright, and developers' names. The File menu lets you specify your printer from a list of approximately a half-dozen brands and models. If your printer is not among them, you can select the Other option or experiment to find a close match. My Epson RX-80 was not listed, so I clicked on Epson MX-80.

From the Size and Style menus, you can alter print appearance in a snap. If your printer supports all these options, you can change pitch (10, 12, or 17) and style (bold, headline, and proportional). Combinations (10 pitch and bold, or bold and headline) are possible—just click on the features you want. From the File menu, you can perform a quick print test: The alphabet spews from your printer in your chosen format.

Continued on p. 92.

THE HANDLERS

VALUE • POWER • SOPHISTICATION • SIMPLICITY

- The Handlers is a software package of three programs; word processing, file management and a spell checker for the Apple II, II+, IIe and IIc.
- The Handlers is *the* answer to programs that cost a lot, take a lifetime to learn and then don't deliver!
- The Handlers delivers the power and sophistication of large scale mainframe systems.
- The Handlers makes immediate sense to the beginner and the experienced computer user.
- More and more people are selecting the Handlers over Appleworks. *Why?* Because the Handlers beats Appleworks for power, ease of use and price! We took the difficulty out of the program when we engineered it so you get what you want out of the Handlers without wasting time.

WORD HANDLER

This best selling WP is surprisingly powerful and yet easy to use.

- Global search & replace
- Block moves
- 40, 66 & 80 column
- Form generator
- Easy to remember mnemonic commands
- Unlimited tabs
- Bold, underline, superscript, justification
- What you see on screen is what you get

LIST HANDLER

A truly fast & efficient file management program.

- Over 3,000 records per disk
- Up to 200 characters per field and 255 fields per record
- Unlimited sorting fields
- Sorts alpha, numeric and date sorts
- Merges with word processors, create form letters
- Sorts 3,000 records in under 45 seconds

SPELL HANDLER

The spell checker that works hand in glove with the Word Handler.

- 90,000 words on one diskette
- Add up to 2,000 of your own words
- No disk swapping
- Scans 10 words per second
- Word count
- If you knew what we know about our products, you'd be our next customer!

Circle 23 on Reader Service Card.

Advanced Logic **als** Systems, Inc.

\$99.95

1195 E. Arques Avenue • Sunnyvale, CA 94086 • 408/730-0307

TAX TIME CAN MEAN RETURNS

by Martin A. Blumenthal

*Make tax time easy.
Find out which
of these
seven tax packages
suits you.*

It's tax time again—and your Apple can take some of the pain out of preparing your returns.

Apple programs designed to help you fill out your income-tax forms can eliminate many of the common errors that delay processing of the return. None of the seven programs I put through their paces (see the accompanying **Table** and Product Information sidebar) signed the return, though, so you won't be able to blame any errors or omissions on your software or hardware.

Some programs require you to do detailed calculations, such as depreciation or capital gains, then type them in as you would on a tax form. The software performs the arithmetic, computes the tax due, and provides a line-by-line print-out of the tax form and any schedules you need. This feature ensures mathematical accuracy and provides you with on-screen "what-if" calculations.

Some of the simpler programs even print a document you can use with plastic overlays and a photocopier to produce a fileable return. Other programs let you align a regular IRS form in your printer, then pop in the numbers right where they belong.

More sophisticated programs provide for more complicated situations (for example, a family in which a husband and wife are both self-employed) in addition to these standard functions. One program

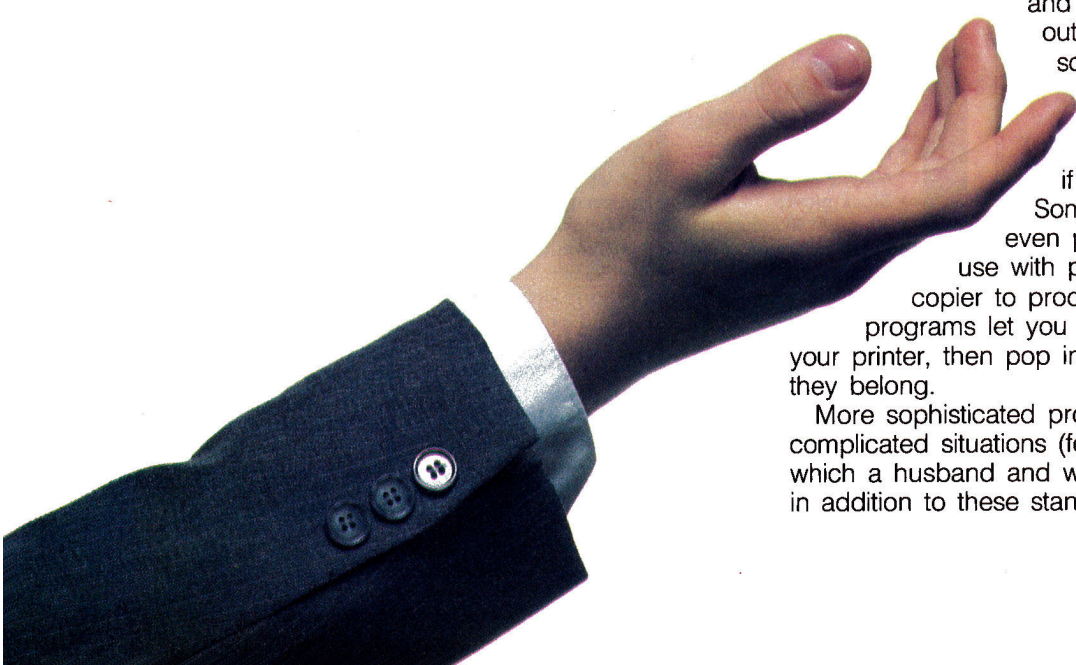

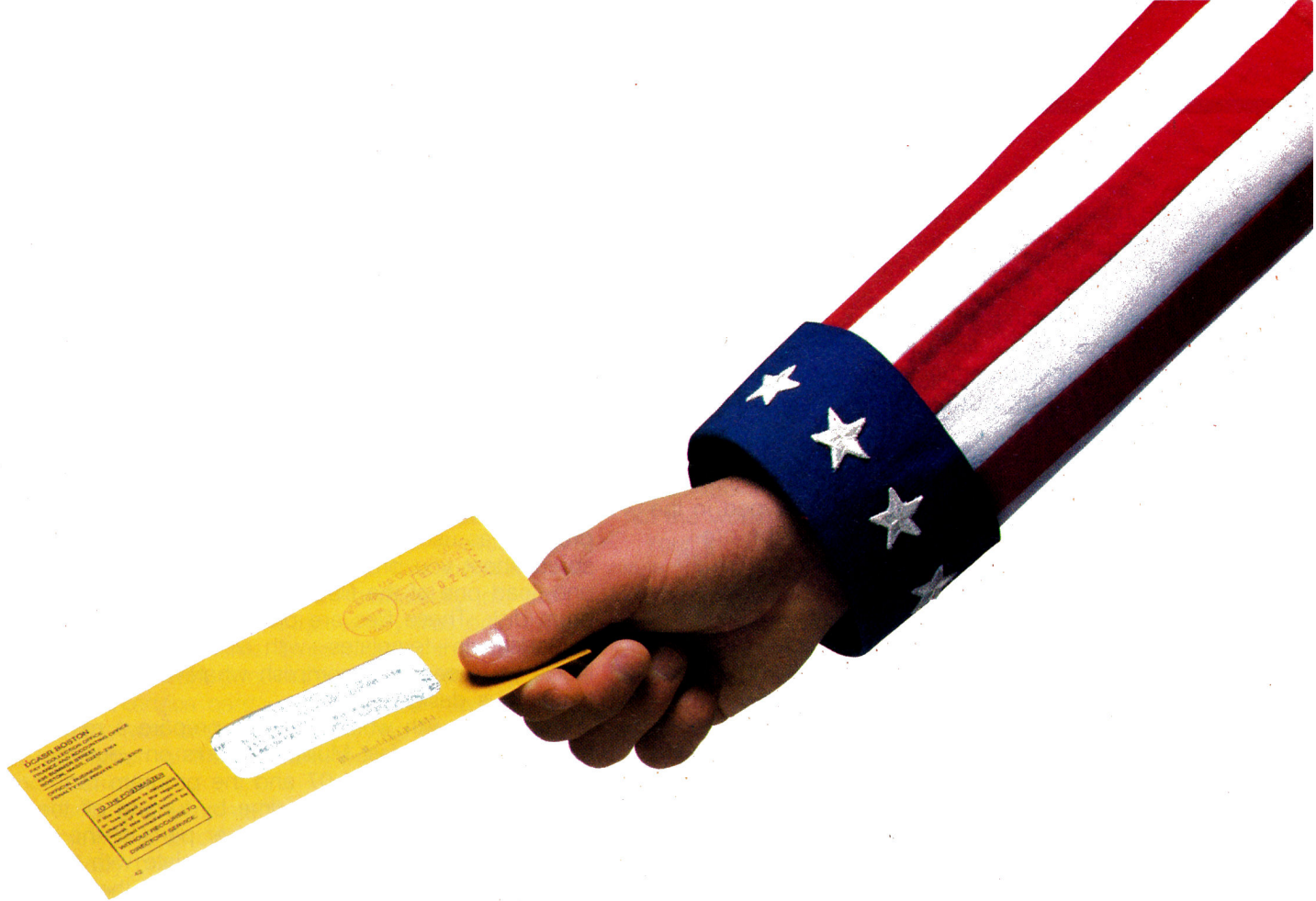

I tested even provides for future tax planning and keeps track of daily tax events.

Updates for most of these programs are available at a reduced rate, so the software is not outdated after one year.

None of the programs can provide legal or tax advice. All of them assume that you're familiar with basic tax law and its ramifications. For complex tax problems, always seek the advice of your certified public accountant or attorney.

I tested each program reviewed here on two of my clients, a married couple. The husband is self-employed; the wife derives some income from self-employment in partnership with her husband, in addition to salary from a full-time job. They have joint income from two rental properties, take the two-wage-earner adjustment, claim the child-care credit, and itemize their deductions.

Tax Command Professional

Practical Programs' Tax Command Professional is a handy package for preparing a simple return and getting instant feedback from changing information. It can either print directly on IRS forms or use the overlays provided by the publisher at an extra charge. (You need a photocopier for the latter option.)

The software contains a built-in calculator, and uses results without requiring further entries.

You have to make subsidiary calculations yourself before you type them into the appropriate form. If you have to calculate depreciation, for example, you must grab your own Form 4562 and fill it out manually, then enter your total on Schedule C (self-em-

ployed income), Schedule E (supplemental income), or Form 2106 (employee expenses).

Aside from several misspellings on screen, Tax Command Professional's format is friendly and easy to figure out. The child-care form (2441) automatically limits your credit, though, depending on the number of children cared for and earned income. On the version I tested, there was no obvious way to change the percentage factor, and the program does not do it for you. In addition, I was confused by one particular notation in line 5 of the child-care form, and the documentation provided no help. You should keep the actual IRS form nearby and continue to compare the screen with the hard copy.

Tax Command Professional's Schedule W (deduction for married taxpayers, both having earned income) is also confusing: When you type in your earned income and your spouse's, negative amounts appear. If both spouses have income from self-employment in addition to wages, you must type in the extra amount specially. Once I typed in the correct numbers, the program calculated the appropriate adjustment. (Again, don't rely on the software alone.)

Even if both spouses have self-employment income, Tax Command Professional can prepare only one Schedule SE. This is a distinct disadvantage: The wife in my test had earned income on which FICA taxes had already been paid, and she can therefore limit the amount paid on her self-employment income.

My //e has a DuoDisk, so I put the program into drive 1 and the data disk into drive 2. Through a menu option, Tax Command Professional lets you utilize two drives to obviate disk swapping. Despite this feature, I couldn't read from or write to the data disk in drive 2 without first running the "catalog" choice on the menu. Fortunately, the program doesn't hang if it tries to read from or write to the program disk.

My clients qualified for income averaging, Schedule G. Tax Command Professional prepared the schedule neatly and automatically after I typed in the prior year's amounts of taxable income. The program then automatically integrated with Form 1040 the tax it calculated.

Tax Preparer

Tax Preparer, from HowardSoft, is a sophisticated tax-preparation program more suited to the taxpayer with a complicated return. Tax Preparer fills out forms and schedules on screen with automatic posting of the results to other forms and schedules. Professional tax preparers can use a high-volume batch method of data entry with hash totals for error checking.

Tax Preparer can print directly on IRS forms or in an IRS-approved format. Itemized details are also available for any particular line (for example, a list of all doctors and hospitals for Schedule A), which the program can also print on a supporting schedule.

The program is menu driven, minimizing the amount of recalculation necessary. It's also useful for year-round tax planning and general recordkeeping for one or more taxpayers.

The program's on-screen preparation of returns is very slow, with numerous writes and reads to and from both program disk and data disk every time it needs to access a new form or schedule. The actual internal calculations also account in part for the program's sluggishness.

A serious limitation of the software is that there is no way to indicate self-employment income from partnerships on Schedule E, or to separate husband's self-employment income from that of the wife. Thus, when you calculate self-employment tax on Schedule SE, you have to type in this information.

The problem arose again on Schedule W (the income from the partnerships is "earned" in this case), but Schedule W can't automatically pick it up, since the two-earner deduction is based on earned income. A similar difficulty comes up in Form 2441 (child-care credit).

I also experienced problems with integrating the amount calculated on Schedules W and G (income averaging) and Form 2441 on Form 1040. After I typed in the information about the partnership income and the corrected adjustment or income tax

calculated, it "disappeared" when I went to Form 1040 to see if the program had correctly picked up the amounts on the schedules and forms.

Tax-Prep

If you're familiar with Multiplan, you'll find EZWare's Tax-Prep fairly easy to use. As a further convenience, the templates are arranged so that you can use the "next free cell" command (control-F) to quickly arrive at the next cell requiring data entry.

If you've never used a template before, a quick explanation is in order. First, boot the spreadsheet program as usual. Then, instead of loading a spreadsheet you prepared yourself or starting a new one, load one of the files from the Tax-Prep program disk. These files are previously arranged spreadsheets—templates—with all the formulas and labels you need to accomplish whatever purpose the template is designed for.

The speed with which you can prepare a return depends on how fast Multiplan works on your machine. I used Version 1.07 and the program ran rather slowly. You can save time by turning off the automatic-recalculation mode. Other parts of the program automatically update each template with the external-copy feature. Since both sides of the disk contain templates, you have to do some flipping during update operations.

One feature I liked very much was the inclusion of template worksheets for calculating things like state and local tax refunds and the charitable deduction for nonitemizers. Another feature of the template is a "window" at the bottom of the screen that cross-references the current template with others, so that you can verify that the program is picking them up properly. The window also displays the "bottom line" of the form or schedule so that you can see the results without leaving the cell you're working on.

The Schedule E template includes provisions to distinguish the husband's partnership income from the wife's, and to show differentiated earned income and self-employment income. The schedules or forms that use these values—Form 2441, Schedule W, and so on—then pick up these amounts. I was able to prepare separate Schedules SE for husband's and wife's self-employment income.

The Form 4562 template includes worksheets for figuring depreciation, but this template is not integrated with the other forms and schedules using Form 4562. You must figure the depreciation, then type in those numbers on Schedule C or E, or wherever you need the depreciation figures.

Most cells are named according to their respective line numbers on the actual tax form. This lets you use the "goto" function to speed travel around the template. Tax-Prep locks cells not requiring entries and cells that pick up their values from other cells, to prevent ruining the template's logic or entering data in the wrong cell.

A tractor-fed Form 1040 came with the software package I reviewed, along with transparency overlays to print the final return. I tried both formats, and each worked well. You can order additional tractor-fed forms from the publisher as well as from certain mail-order computer-supply houses.

TaxWorks

Because of publishing deadlines, I received only a preproduction version of TaxWorks from Personal Financial Services. It's worthy of mention, though, since it could well be the fastest tax-preparation package available for the Apple. My //e is equipped with a RamWorks II card with 512K. I've modified my AppleWorks program to load completely into the card, letting me load all the necessary files onto the desktop at the same time. Unfortunately, the RamWorks card's current print buffer works with only one printer-interface card—not the type I have—so my machine was tied up while printing forms. This isn't a limitation of the software, but of the RamWorks II card.

TaxWorks is a template-based operation that uses the AppleWorks spreadsheet. AppleWorks lacks the external-copy command and next-available-cell option Multiplan has. TaxWorks does include a "transfer port," however: You retype data needed by the other templates, and the information is then transferred, via the clipboard, to another template. A fold-out roadmap of each template would be a handy reference, since it's easy to get lost in large spreadsheets.

TaxWorks is also set up to take into account two incomes derived from self-employment, a feature not found in some programs costing ten times as much.

Since the production version of TaxWorks wasn't complete, I couldn't run through the whole test model—but for \$21.95 you can't go wrong trying this one out.

J. K. Lasser's Your Income Tax

Simon & Schuster's tax package is a computerized version of the familiar yellow-and-red paperback *Your Income Tax*, by J.K. Lasser, that you see on all the newsstands during tax season. In fact, the book is included with the documentation and disk so that you can look up specific tax questions as you progress through the program. Each part of the program includes automatic, on-screen references.

I liked the program's use of windowing to show prompts and a list of commands at the bottom of the screen. In fact, the only commands listed are ones that will work when the cursor is at its current position. The program also includes a convenient built-in calculator.

The program begins with an "interview" that asks questions such as names (even spouses with different last names), address, dependents, and so on. The program even selects the forms you need by asking several optional questions. (You can also select your forms directly.)

The manual instructs you to prepare a working copy of the program, but doesn't mention the blank, formatted disk you'll need. Don't get caught—when the program prompts you after the interview to insert a disk into the drive, it's referring to the blank disk, not the working copy.

Your Income Tax runs fairly fast and produces results immediately. You can therefore play many "what-if" games without wasting a lot of time (it's designed for moderately complex returns). Of all the nonspreadsheet-based programs I tested, this was the fastest. Once I typed in a number and pressed the return key, the cursor jumped immediately to the next place an entry was required.

Form 4562 didn't compute depreciation; I had to fill in the blanks with precalculated amounts.

I started the program with Form 1040. When I came to a line that required another form, such as Schedule E, I used the "go-to" command, which took me automatically to that schedule, then returned me to Form 1040 at the spot where I had left off.

The program doesn't include itemizing capabilities. Your Income Tax can prepare worksheets, but they're of a *proforma* nature; you must print them immediately or the program will erase them if you prepare another worksheet.

Schedule E can't differentiate husband's income from wife's or earned from nonearned. I had to type in these amounts on Schedule W and Form 2441 myself. A more serious limitation is the program's inability to prepare a separate Schedule SE for a spouse. I was a little confused when I reached line 38 to figure the tax, since I used Schedule G. The go-to command didn't work as I expected. I finally figured out that I had to save and exit Form 1040 first, then choose Schedule G from the menu.

I found the printing sequence confusing. The menu should have been in two stages—first, a choice of form, then whether you want to print on a



computer form or a government form. As it's set up, you have to guess at the steps required to print a form. And, although the program is supposed to work with most popular printers, I couldn't get an intelligible printout from my Epson RX-80 FT, which is as ubiquitous as an Apple II.

The Tax Advantage

Arrays' Tax Advantage is for the average taxpayer whose return doesn't require very much detail. The forms and schedules performed flawlessly, and I had no trouble getting correct feedback. The program can produce form printouts acceptable to the IRS, but it can't print a 1040. You have to copy the numbers the program generates onto a regular Form 1040.

The Tax Advantage cannot prepare a separate Schedule SE for the taxpayer's spouse. At the level to which this program seems to be geared, that feature would probably not be used anyway. You must calculate depreciation manually before you type it in on Form 4562. The program cannot differentiate husband's and wife's partnership income, or whether or not it's earned or self-employment income. To get the correct results, though, you can easily type in these numbers on the forms or schedules requiring this information.

I found the program extremely slow, both in execution and in data entry. All the other programs I reviewed make use of the arrow keys, and require you to put the cursor on the point where you want to type in data. The Tax Advantage requires you to press various letter keys to move an on-screen arrow (D for down, U for up, and so on). When the arrow hits the correct line you then have to press E to finally enter the number—a big waste of time.

The preparation sequence is logical. I started with Form 1040, and when I got to a point where I needed another schedule, pressing I brought me (after a minute or so) to the required form. For example, when I came to line 18 for Schedule E's rents, royalties, and so on, I typed I and filled out the schedule. When I quit the schedule the program returned me to the place where I had left off on Form 1040.

The Tax Advantage is useful for tax planning during the year, as you can type in checkbook data at any time to get an idea of what to expect at the end of the year. You may see, for example, that a contribution to your IRA would be advantageous now instead of waiting until next April 15th.

TaxCalc

TaxCalc isn't a tax-preparation program, per se. This nifty software is actually a tax-planning package, but is certainly worthy of mention here. It requires a spreadsheet, and many of the popular programs are compatible with it. I tried the AppleWorks version. TaxCalc's files are actually VisiCalc files, and you must load them as such with the AppleWorks load-files option.

The template I looked at was for a married couple, filing jointly. It shows three columns side by side, labeled alternative 1, alternative 2, and alternative 3, respectively. The extreme left-hand columns correspond to the lines in various tax forms and schedules. You then type in corresponding numbers under the appropriate alternative.

Let's say you wanted to see what your tax situation would be if you had fewer medical deductions but more sales tax compared to your original set of data. You would put those new numbers under alternative 2 and compare results side by side with your original plan (alternative 1). You can prepare a third alternative the same way. And, although TaxCalc doesn't print tax forms, you can print the template for study with the usual spreadsheet print options.

TaxCalc works fast, and is invaluable for professionals who want to quickly check their calculations after preparing a return in the conventional manner, or to fill out a summary sheet for a commercial tax-processing service.

Product Information

AppleWorks

Apple Computer
20525 Mariani Avenue
Cupertino, CA 95014
(408) 996-1010
\$250

Reader Service Number 336

J. K. Lasser's Your Income Tax

Simon & Schuster Computer Software
1230 Avenue of the Americas
New York, NY 10020
(212) 245-6400
\$69.95

Reader Service Number 337

Multiplan

Microsoft
10700 Northup Way
Bellevue, WA 98009
(206) 828-8080
(800) 426-9400
\$195

Reader Service Number 338

The Tax Advantage

Arrays/Continental Software
6711 Valjean Avenue
Van Nuys, CA 91406
(818) 994-1899

Reader Service Number 339

TaxCalc

TaxCalc Software
4210 West Vickery Boulevard
Fort Worth, TX 76017
(817) 738-3122
\$150

Reader Service Number 340

Tax Command Professional

Practical Programs
P.O. Box 93104
Milwaukee, WI 53203
(414) 278-0829
\$59.95

Reader Service Number 341

Tax-Prep

EZWare Corporation
29 Bala Avenue
Bala-Cynwyd, PA 19004
(215) 667-4064
\$95

Reader Service Number 342

Tax Preparer

HowardSoft
1224 Prospect Street
Suite 150
La Jolla, CA 92037
\$250

Reader Service Number 343

TaxWorks

Personal Financial Services
P.O. Box 1401
Melville, NY 11747
(516) 261-8652
\$19.95 (plus \$2 postage)

Reader Service Number 344

Table. Comparison chart for seven tax-preparation packages: ratings, system requirements, and forms produced.



| Product Ratings | Ease of setup | Ease of use | Documentation | Support | Overall |
|-----------------|---------------|-------------|---------------|---------|---------|
| Tax Command | ■■■ | ■■■ | ■■■ | ■■■ | ■■■ |
| Tax Preparer | ■■■ | ■■■ | ■■■■ | ■■■ | ■■■ |
| Tax-Prep | ■■■■ | ■■■ | ■■■■ | ■■■ | ■■■ |
| TaxWorks | ■■■■ | ■■■■ | N/A | N/A | N/A |
| Your Income Tax | ■■■ | ■■■ | ■■ | ■■■ | ■■■ |
| Tax Advantage | ■■■ | ■■ | ■■■■ | ■■■ | ■■ |
| TaxCalc | ■■■■ | ■■ | ■ | ■■■ | ■■■ |

N/A = not applicable (preproduction version reviewed)

See Reviews (p. 30) for ratings key.

| Product | System requirements | Forms and schedules produced |
|-----------------|--|--|
| Tax Command | Any 64K Apple II, one disk drive; two drives and printer recommended | 1040, 2106, 2119, 2441, 3903, A, B, C, D, E, G, R, SE |
| Tax Preparer | Any 64K Apple II, Applesoft; extended 80-column card and two drives recommended | 1040, 2106, 2119, 2210, 2441, 3468, 3903, 4562, 4797, 5695, 6251, A, B, C, D, E, F, G, R, SE, W |
| Tax-Prep | Any 64K Apple II, one disk drive, Multiplan; 128K, printer, and two drives recommended | 1040, 2106, 2119, 2210, 2441, 3468, 3903, 4562, 4684, 4797, 5695, 6251, 6252, A, B, C, D, E, F, G, R, SE, W |
| TaxWorks | Apple //c, 128K //e, one disk drive, AppleWorks; two drives and printer recommended | 1040, 2441, 3468, 5695, 6251, A, B, C, D, E, G, SE, W |
| Your Income Tax | Any 64K Apple II, one disk drive, 80-column card; printer and two drives recommended | 1040, 1040A, 1040EZ, 2106, 2119, 2210, 2441, 3468, 3903, 4137, 4562, 4684, 4797, 4835, 5329, 5695, 6251, 6252, A, B, C, D, E, F, G, R, SE, W |
| Tax Advantage | Any 48K Apple II, one disk drive, Applesoft; two drives and printer recommended | 1040, 2106, 2441, 4562, 6251, A, B, C, D, E, G, SE, W |
| TaxCalc | Any 64K Apple II or III, spreadsheet program | not applicable |

The Bottom Line

Now that you've read all this, you're probably wondering which package is the one for you. If you have a simple return, any of the programs will do, although the more sophisticated ones would be overkill. If you own Multiplan or AppleWorks, the tax programs that work with them are excellent. (I prefer AppleWorks, since it runs much faster than Multiplan on my machine.)

If you're a professional preparer, printing capability as well as complexity is a factor. Be aware that preparing two Schedules SE is rather common, so watch for the availability of that feature. If you use a commercial tax-preparation service, either Tax Command Professional or TaxCalc would be ideal for calculating the summary-sheet numbers that compare your computations with those of the mainframe.

These two programs can also compute tax very quickly, and figure medical deductions and sales-tax base. Of course, price is an important factor you should consider. And, by the way, if you do use a particular program to prepare your taxes, it's a deductible expense if you itemize. ■

Martin Blumenthal is an attorney and certified public accountant. Write to him at 105 West Madison, Chicago, IL 60602.

Editor's note: Income-tax software we received too late for editorial review in this article includes Andrew Tobias' Managing Your Money (MECA, 285 Riverside Avenue, Westport, CT 06880, 203-222-1000, \$69.95). Watch for our review in May.

DO YOU KNOW WHERE YOUR MONEY IS ?

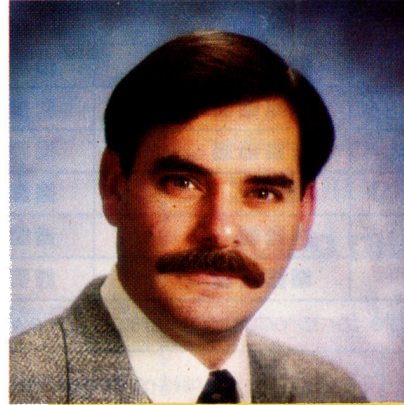

If tax time has left you in the poorhouse, Jack Moore's tips for finding the right financial-planning software might put you in better shape next year.

by Deborah de Peyster, Editor

It's tax time. Do you know where your money is? People often don't really know what their financial situation is until they've completed Form 1040 and find the government gets it all. Meeting the bill might even require taking out a fast loan. And that's when you hear people say, "Next year I'm going to do this better. I'm not going to pay so much."

Knowing where your money is—that's what financial planning is all about. It makes your money work for you by anticipating your needs and wants. And we can't think of a more appropriate time to get you thinking about better financial planning than right now.

inCider recently interviewed Jack Moore, chief executive officer of Manzanita Software Systems, for his advice on what to look for in financial-planning software. For 13 years Moore was a CPA in his own firm, which emphasized financial planning for individuals. He now heads the Roseville, California-based Manzanita Software, which produces a full accounting system for business.

Our focus in this interview is on what individuals should look for in financial-planning packages. While individuals' planning needs vary widely, certain key items should be considered by all. Moore reviews six important factors to keep in mind when shopping for your software. We hope his insight will help you avoid what he describes as an all-too-frequent occurrence at tax

time: "Your accountant calls on April 14 just when you're sitting down to dinner, and he says, 'I've completed your taxes and you owe another \$5,000.' "

1. Does the software reflect the sort of person you are?

If you don't like taking the time to even balance your checkbook, then financial-planning software that requires you to enter information weekly isn't going to help you. A program that operates around specifically defined categories may also not be for you. In fact, something as free-form as the spreadsheet in AppleWorks might be all you need. You could design your own categories and use them to keep track of expenses and income at your own pace.

On the other hand, if you're not terribly organized, yet want some structure, you might do well with a highly systematized financial-planning package. But the key element here, Moore urges, is to "sit down and determine what kind of person you are."

2. How much time will operating the software take?

You can buy the most sophisticated financial-planning package available, with personal-asset management, property management, portfolio management, and communications, but if you're not willing to sit down and make those features work, it's worthless. "You have to assess the package's requirements versus your own. If the package is going to require time to make it work, you have to be willing to give it that time," Moore points out.

FREE 15-DAY TRIAL OFFER

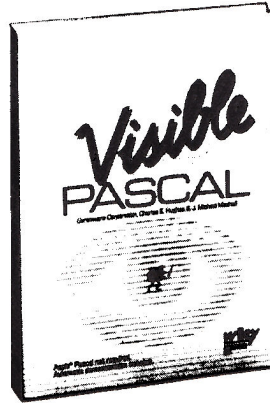

“Visible Pascal is one software package that anyone

considering learning a computer language should look into.”

—Erik Sandberg-Diment
The New York Times
August 6, 1985

The critics are raving about **Visible Pascal**. **Visible PASCAL**, the first interactive learning tool, has added fun to learning the PASCAL programming language.

Take advantage of this **FREE 15-day trial offer**.
Call **Wiley Professional Software** at
212-850-6788.

Visible PASCAL \$59.95 ISBN 0471-88820-6

Developed by **Gentleware Corporation**

Requirements: Apple® II, (with language card), II+, IIc or IIe, 64K RAM. Game paddles or joysticks recommended, though not required except for the Artist program.

Examine the documentation only **FREE** for 15 days. Either keep your **Visible PASCAL** and return the accompanying invoice with your payment (including postage and handling, plus local sales tax) or return it within 15 days without further obligation.

Note: Returns will not be accepted if the seal covering the program disk is broken.

Or write: Wiley Professional Software

Attn: Leslie Bixel
John Wiley & Sons, Inc.
605 Third Avenue
New York, N.Y. 10158



wiley
PROFESSIONAL
SOFTWARE

Institutional discounts available.

Apple™ is a registered trademark of Apple Computer Inc.

3. Do the program's features meet your needs?

“Look ahead three or four years, try to see where you're going to be, and make sure the package fits you,” Moore says. Don't make the mistake of buying a planning package that reflects only what your expenses, income, and investments are today.

For example, ask yourself, “Will I, in the next few years, frequently trade stocks and bonds, own property, collect antiques, art, or automobiles, want to set up a trust fund, or increase my savings?” The list can be long, and it's different for everyone. But it's important to make a list of the things you think you might want to do and find a package that will grow with you.

Some basic features you might want to consider include the ability to manage your checking account, prepare an income statement, create financial statements, track items that are important for income-tax return, plan and budget, and set up a balance sheet. A more sophisticated system might contain more than one program to handle communications, high-level management of property and assets, and perhaps certain aspects of a full accounting system, such as general ledger and payables to maintain billing.

4. Does the package offer the ability to ask “what if” questions?

You need to be able to juggle your finances to get the best solution to your needs. For example, you might want to analyze borrowing, saving, and investment decisions, or create an amortization table to display principal and interest payments on a loan. The questions might be as simple as “If I save 10 percent of my salary each month, will I still be able to afford a two-week vacation?” Or the questions may involve very complex investment decisions. But at whatever level you manage your finances, the ability to easily do a “what if” scenario is key.

5. How does the package's terminology compare with the language on your Form 1040?

A concise breakdown of income and expense items that more or less corresponds to your income-tax return is a convenience to look for. “What I envision people doing at home is pulling figures from last year's income tax and using them for planning the current year's finances,” Moore says. Corresponding words and categories make that transfer of information easier.

6. Do you enjoy using the program?

You'll be using this software for the next couple of years. And using it requires some work, so it's important that you feel comfortable with it. “The biggest mistake you can make is to do nothing,” Moore advises. “A little bit of planning is better than none at all.” ■

If a train leaves New York for C

inCider examines the newest controversy in education, as teachers and developers debate the value of drill-and-practice vs. critical-thinking software.

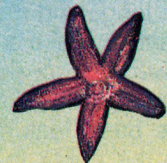
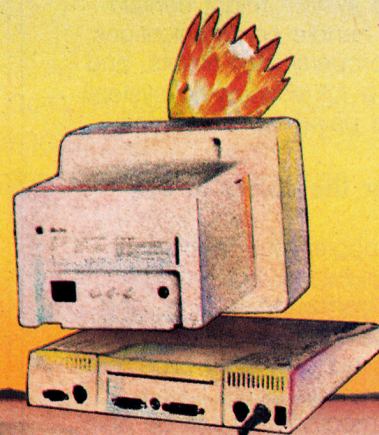



DO DRILLS MAKE DRONES?

by Wendy Lea McKibbin, *inCider* staff

Our children may not be developing the skills they need to cope with the ever-changing world around them. They use computers in school to help enhance their learning skills, but the software they use may not be teaching them to think. We're happy when they receive an A after successfully completing a test that requires memorization of facts. But are such drills really teaching them to reason?

Some educators say no. They say that teachers too often rely on only one type of software—"drill and practice"—which teaches memorization and response, not how to think. But if those educators have anything to say about it, changes are on the way.

The Electronic Workbook

Drill-and-practice software, once a *de facto* standard in the computer-equipped classroom, is losing ground to more innovative uses of the microcomputer, according to developers and researchers who follow the educational-software industry. The change comes in response to a growing number of educators promoting the development of higher-order thinking skills. (See the accompanying sidebar for a list of current programs designed to encourage these abilities.)

Even Apple Computer Inc. president John Sculley challenged the value of using only drill-and-practice programs in the classroom at a conference in San Francisco in January: "Are the students who will be hired in the year 2000—the students in school right now—learning the kinds of skills that will allow them to succeed?"



“There must be renewed emphasis on teaching students how to think.”

“The answer, I believe, is ‘only partially’. . . schools are only beginning to teach students how to use computers to obtain information, to think, and to make decisions. There’s real value in using computers for drill and practice, or learning how to program, but we think students would be better served by learning how to use computers as lifelong tools to get work done.”

One person who has closely watched the educational market is software developer Joyce Hakansson, formerly of Children’s Television Workshop. She explains that drill-and-practice software originally functioned as a replacement for the workbook. It was the easiest way to use a computer in the classroom, and it made demands on the teacher more tolerable. But, she notes, it’s “not where the power of the medium lies.” She adds, “Educators are becoming less and less satisfied with rote learning because it’s now much more important for people to find information, evaluate it, and use it to solve problems than it is to simply store data in their minds.”

To be sure, some areas of learning, such as arithmetic and foreign languages, are best served by rote memorization of facts, but no one says education should stop there, Hakansson concludes. (For related discussions of computer use in U.S. schools, see “Apples in Class: The Latest in Team Teaching,” p. 101; “Guidelines for Buying Educational Software,” p. 109; and “Community Consensus: Computers in Education,” p. 122, all in the November 1985 *inCider*; and “BackTalk Response: Computers in the Classroom,” January 1986, p. 44.)

A Society of Thinkers

The National School Board Association (NSBA) is among those organizations that agree that students need more than a passive, rote-directed approach to learning if they’re to survive in tomorrow’s society. The Alexandria, Virginia-based group recently urged schools to adopt new curricula to promote the development of critical-thinking skills.

Philip A. Smith, director of communications for the association, says that the NSBA’s recommendation is based on studies indicating the need for reform and for a higher quality of learning. “The board’s suggestions are a reaction to a new view of reality in the world, a vision of what tomorrow’s generation will have to cope with and the skills it will need for survival,” Smith explains. “Above all, there is a feeling that there must be a renewed emphasis on teaching students how to think in order to improve the quality of education.”

Software that teaches higher-order thinking skills is designed to prepare kids for a world that today’s adults do not anticipate, according to Marge Kosel, vice president of Sunburst Communications’ software division in Pleasantville, New York. “We’re switching from a factory-driven society to a society of think-

ers,” Kosel observes. “The jobs of the future will require thinking skills, synthesis, and problem-solving abilities.”

What exactly are these problem-solving skills some educators prize so highly? Kosel says that one of them is the facility for recognizing patterns: “There are patterns in nature as well as in math and language, and a child can learn to recognize these relationships.”

Other skills are the ability to break a problem down into smaller components, the know-how to solve a problem through trial and error, and the ability to work backward from a desired conclusion to the correct premise. A software package aimed at developing these skills challenges a child to put together assorted information to solve a problem, while drill-and-practice programs seek a predetermined answer.

Innovation vs. Reality

Although many educators laud the appearance of computer-based courseware that encourages creative and abstract thinking, not all classroom teachers have jumped on the bandwagon. In fact, according to Bodie Marx, vice president of Mindscape Inc., of Northbrook, Illinois, something like a battle line has been drawn between computer coordinators, who have been assigned to schools to assess software needs, and classroom teachers, who are faced with actually executing the new programs. Marx, a former teacher of high-school French, notes the growth of “tension” between the two camps and suggests that those products aimed strictly at development of higher-order thinking are likely to be rejected at the classroom level.

The computer coordinator is interested in innovation—the “latest and greatest” in problem-solving and critical-thinking programs—and tends to have an idealistic view of the classroom, Marx says. The teacher, on the other hand, is concerned primarily with ease of use, integration, and accountability—that is, the teacher’s views are usually rooted in day-to-day reality. Marx says that coordinators who push too hard for innovation are likely to experience a backlash from teachers, with the result that computers in the classroom are either used inefficiently or not used at all.

“In order for the medium to survive and to be used to its fullest potential, it must be integrated into the existing classroom environment,” Marx comments. He adds that teachers are challenged because they are held accountable for the time children spend at the terminal, and in many schools, this amounts to only about 20 minutes per student per week. It’s also difficult for teachers to follow the individual progress of students in a group setting like the computer lab. Thus, Marx says, most teachers are still more comfortable with drill-and-practice software, given the existing classroom structure, than

with any other type of program—it's the easiest to track and manage.

The Challenge of Integration

To the concerns some teachers have about integrating critical-thinking skills software into the curriculum, Dr. Alfred Bork of the University of California at Irvine adds another: namely, that some problem-solving programs are so sophisticated that only 1 percent of the population can use them. Dr. Bork, who is developing software to teach junior-high students how to think like scientists, suspects that the students who can use the most advanced programs would probably be good critical thinkers anyway—even without the software.

The real issue for computers in education, according to Dr. Bork, is the need for new curricula that take advantage of computers in classrooms. Doing this requires courseware that includes both drill-and-practice and problem-solving material, yet goes far

beyond the scope of today's software.

"It's as if someone were turning out two kinds of two-page books, and people were debating about which type is better," Dr. Bork says. "The software being used right now in the classroom—be it drill-and-practice or problem-solving—is like a two-page book. What we need is a whole book, or in this case, a whole-course approach to classroom teaching that makes better use of the computer than we're now doing."

Better computer-based courseware solutions could come from educators, developers, hardware manufacturers, private industry, or the federal government, Dr. Bork notes. The important thing to remember, he concludes, is that we must come up with new solutions if we're to prevent further decline in the quality of education in the U.S. in the next decade. ■

Write to Wendy Lea McKibbin c/o inCider, Suite C-200, 1060 Marsh Road, Menlo Park, CA 94025.



Higher-Order Thinking-Skills Software

Gertrude's Puzzles

Ages 8–12, \$44.95
Encourages children to think analytically and to identify multiple solutions to complex problems.

Gertrude's Secrets

Ages 5–9, \$44.95
Shapes and colors teach general classification skills, such as grouping, sequencing, and organizing.

Robot Odyssey I

Ages 12 and up, \$49.95
Five tutorials that test logic skills while building scientific problem-solving abilities.

Rocky's Boots

Ages 9 and up, \$44.95
Winner of the 1985 Parents' Choice award. Uses basic electronic circuitry to teach problem solving, reasoning, and creative thinking.

The Learning Company
547 Middlefield Road
Suite 170
Menlo Park, CA 94025
(415) 328-5410

Reader Service Number 300

Where in the World Is Carmen Sandiego?

Ages 8 and up, \$39.95
Teaches geography and reasoning skills.

Broderbund Software
17 Paul Drive
San Rafael, CA 94903
(415) 479-1170

Reader Service Number 301

Delta Drawing

Ages 7–10, \$39.95
Basic introduction to computing concepts. Teaches children about programming through experimentation.

In Search of the Most Amazing Thing

Ages 9–15, \$32.95
Develops decision-making skills as students use numeric quantities to find the most amazing thing in the universe.

Spinnaker Software
One Kendall Square
Cambridge, MA 02139
(617) 494-1200

Reader Service Number 302

Logo

Ages 8 to adult, \$100
A programming language that teaches problem-solving skills and complex programming concepts. Encourages development of visual reasoning, logic skills, and the ability to break problems down into simple components.

Apple Computer
20525 Mariani Avenue
Cupertino, CA 95014
(408) 996-1010

Reader Service Number 303

Archon

Fourth grade to adult, \$39.95
Action-strategy chess promotes logical and strategic thinking.

Electronic Arts
2755 Campus Drive
San Mateo, CA 94403
(415) 571-7171

Reader Service Number 304

The Factory

Fourth grade to adult, \$59
Teaches inductive reasoning and the impact of sequence.

The Incredible Laboratory

Third grade to adult, \$59
Simulated beaker and chemicals let students practice refining information through research and implementation.

The King's Rule

Fourth grade to adult, \$59
Encourages formation and testing of hypotheses, and recognition of patterns and relationships.

The Pond

Second grade to adult, \$59
A frog lost in a pond teaches pattern recognition and logical thinking.

The Puzzle Tank

Fourth grade to adult, \$59
Math helps develop inductive reasoning skills as students fill, empty, and transfer liquids from tank to tank.

Sunburst Communications
39 Washington Avenue
Pleasantville, NY 10570
(914) 769-5030

Reader Service Number 305

THE *Magic* OF THE VISUAL INTERFACE

Apple II users can now have the best of both worlds with a new breed of Mac-like software.

by Cynthia E. Field

Be honest, now. Have you had that uneasy feeling lately that maybe—just maybe—you own the wrong computer?

Some of your friends may have jumped on the Commodore Amiga bandwagon this past Christmas. Others rave about the Atari 520 ST. You may even know one of "the rest of them"—the Macintosh owners. Then there's you, the Apple II loyalist. Should you carry your tail between your legs?

Unlike users of those other machines, you've never had to worry about good software being available, and lots of it. Whether you purchased a //e or //c, you were confident that some expansion would be possible.

Well, that time has come. With just a hardware enhancement or two, you can enjoy the newest breed of software, a genre that's only beginning to exploit what Cary Lu in *The Apple Macintosh Book* dubs "the visual interface."

Best of all, we don't have to give up anything. We can still enjoy thousands of traditional, keyboard-driven programs along with the new Mac-style packages—the best of both worlds.

A Little History

The prototype for what we call the Macintosh interface was actually developed by a team working at



Xerox Corporation's Palo Alto Research Center (PARC) in California. In the 1970's, the PARC group created a software working environment capable of utilizing the hardware mouse. Apple incorporated this interface into its Lisa and Macintosh computers in the early 1980's.

The Mac's graphic interface, with its pull-down menus, icons, windows, and mouse input, has since served as a model for easy-to-use but powerful software for other computers, including the Amiga, the 520 ST, and now the Apple //e and //c.

Hardware Considerations

If you want to run truly Mac-like software on your Apple II, there are three prerequisites. (See the **Table** for a quick comparison of system requirements for nine programs discussed in this article.) First, your computer has to be able to display menu bars, window frames, check marks, and other graphics. Older //e's were shipped without this "mouse text," an alternate character set. But for less than \$100, your dealer should be able to add the ROM (read-only memory) upgrade required for mouse-text display.

Second, most Macintosh-like programs for the Apple II require 128K of RAM (random-access memory). Many Apple //e's now being sold come with 128K. If you didn't purchase your //e within the last six months, you may need to buy an extended-memory

circuit card. You should be able to add 64K to your Apple //e for about \$100. The //c comes with mouse text and 128K as standard features.

The third enhancement you need is a mouse. If you're using a //e, the mouse requires an interface card in slot 4. An **AppleMouse //e** with interface costs about \$150.

The mouse interface is built into the //c, and owners have a choice of mice. The **AppleMouse** (\$100 for the //c) is a mechanical mouse, with a hard rubber ball in its base. As you glide the mouse over the surface of your table or desk, the ball rotates, and the mouse's relative position is translated into a particular cursor position on the monitor screen. Moving the mouse left moves the cursor left, and so on.

The second type of mouse available for the //c is the optical **A+ Mouse** (reviewed in the July 1985 *inCider*, p. 77) from Mouse Systems. Instead of a rolling ball, the optical mouse's infrared light-emitting diodes and photosensor track the device's position on a mouse pad. This metal-based, skidproof pad is about 9 inches by 8 inches in size; its upper surface is composed of a grid of thin horizontal and vertical lines. The A+ Mouse lists for \$99.

Whether you prefer a mechanical or an optical mouse will depend more on how each feels in your hand rather than how it functions. With either variety, you glide the mouse along and press the button on



Your Apple IIc deserves the time of day.



Our IIc System Clock offers automatic time and date stamping, puts time, year, month, date and day of week right on your screen!

Applied Engineering's revolutionary IIc System AClock plugs into either your modem or printer serial port ... and displays the time and date right on the AppleWorks screen. The time feature includes hours, minutes and seconds, and the date includes year, month, date and day of week.

All your work is *automatically* time and date stamped to give you a complete record of your work history. And since it's from Applied Engineering, you'll get our famous no-hassle five year warranty and a price that will persuade you.

FOR JUST \$79, you can give your IIc the time of day, plus much more.

- Fully PRO-DOS compatible
- Automatic time and date stamping
- Easy to use from BASIC
- Date includes year, month, date and day of week
- Time includes hours, minutes, seconds
- Time and date stamps AppleWorks files
- Auto-access from AppleWorks database
- No-hassle five year warranty

Call 214-241-6060 TO ORDER TODAY 9 a.m. to 11 p.m. seven days, or send check or money order to Applied Engineering. MasterCard, Visa and C.O.D. welcome. Texas residents add 5½% sales tax. Add \$10.00 outside U.S.A.

AE Applied Engineering
P.O. Box 798, Carrollton, TX 75006
(214) 241-6060

top to select choices from on-screen menus. Some users say the optical mouse is lighter to the touch, but others find the mouse pad too restrictive.

Mac Savoir Faire

In the technical sense, the ideal Mac-like program for the Apple II would offer everything available on the Mac: icons, pull-down menus, dialog boxes, windows, scroll bars, and, of course, mouse input. To date, few programs for the Apple II have all these embellishments. The availability of Mac-like software for the Apple II has been a step-by-step, evolutionary process. I like to think of these programs as reaching Level 1, 2, or 3 in their attainment of Mac emulation.

Level 1 software takes the first step toward embracing the Mac interface—mouse support or pull-down menus.

Level 2 software moves a step closer by mimicking Macintosh applications software, with dialog boxes, windows, close boxes, and scroll bars, in addition to mouse support and pull-down menus.

Level 3 programs have it all—Level 2 features plus icons. The graphics and text in these programs make your Apple II screen look like the Macintosh's.

Table. Comparison chart showing prices and system requirements for nine Mac-emulating packages.

| Program, Price | Requirements | | |
|--------------------------------|--------------|------|--------------|
| | Mouse | 128K | Enhanced ROM |
| MouseWrite, \$125 | | • | • |
| Mouse Word, \$129.95 | • | • | |
| Mouse Calc, \$149.95 | • | • | |
| Dazzle Draw, \$59.95 | | • | |
| Fantavision, \$49.95 | | | |
| Mouse Budget, \$69.95 | • | • | • |
| Person-to-Person, \$100/\$150* | • | • | |
| Mouse Desk, \$39.95/\$69.95* | | • | |
| Catalyst 3.0, \$99 | | • | • |

*The second price is for the noncopy-protected version.

Mice and Menus

Certain Level 1 programs—Broderbund's **Bank Street Writer** and **Print Shop Companion**, and **ProCom-A Communications Software**, published by modem manufacturer Prometheus Products—support the mouse as a menu selector only.

Other publishers have designed their programs to

support the mouse as a substitute for the joystick. In DesignWare's **European Nations and Locations**, you use the mouse to drag a country and click it into place on your on-screen map of Europe. In Mindplay's **Cat 'n' Mouse**, children learn word and picture associations by using a hardware mouse to help a software mouse through a maze. In Weekly Reader Family Software's **StickyBear SpellGrabber**, moving the mouse moves StickyBear around the screen, where he picks up letters to complete a word.

These programs are not truly Mac-like, nor were they intended to be. They're significant, though, because they bring mouse-driven software to the unenhanced Apple II and represent transitional stages in Mac emulation.

Pull-Down Menus

Some Level 1 programs offer pull-down menus in place of standard (key-selected) menu listings. In the Mac environment, menu titles are presented banner-like across the top of the screen. Mac aficionados call this array of choices the *menu bar*.

In a word-processing program, for example, the menu bar might contain the words File, Edit, Print, and so forth. If you want to save your document, you simply use the mouse to move the on-screen pointer to the word File. When you press the button on top of the mouse, the File menu pulls down like a window shade to display a list of file-management options such as New, Open, and Save.

Release the button when the highlighting cursor lands on the option you want. Sometimes submenus open up when you select from a pull-down menu.

At least two programs offer pull-down menus, but don't support the mouse. In Timeworks' Sylvia Porter's **Your Personal Financial Planner** (reviewed on p. 36 in this issue) and in **Pinpoint** (see "Desktop Power," March 1986, p. 34), you use the directional and return keys to move from menu to menu and select program features.

The II Does Windows

To date, Level 2 programs dominate the Mac-like Apple II scene and clearly establish the trend toward visual-interface software. Depending on the extent to which a program mimics the Mac, dialog boxes may appear on screen when the program needs more input.

A word-processing program may ask which drive contains your data disk, for instance. If the program can't proceed without further input, it may beep you, open a dialog box, and ask you if it's all right to go on. The program may require you to click on the word OK; if it's not, you click on the word CANCEL.

Some Mac-like programs do windows. These rectangular boxes can help you partition your work area. A word processor, for example, may let you open a second window so that you have two "pages"

With Z-80 Plus,TM run CP/M[®]—the largest body of software in existence.

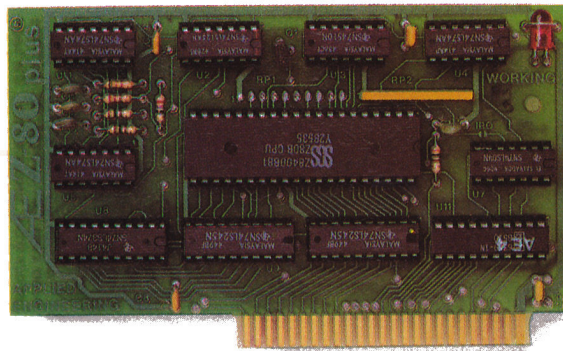

*Now, get two computers in one,
and all the advantages of both.*

Enter the CP/M world with the new Z-80 Plus card from Applied Engineering, and introduce your Apple IIe[®] or II +[®] to the thousands of CP/M programs. Only the Z-80 Plus comes standard with the new 4.0 software, the most advanced system ever for running CP/M programs.

The new 4.0 boasts advanced features like built-in disk emulation for popular memory expansion boards, boosting both system speed and storage capacity. And menu-driven utilities that let you get to work faster. The Z-80 Plus also lets you run older CP/M programs — all the way down to Version 1.6 (2.2 is the most popular).

The Z-80 Plus is the only card on the market capable of accessing more than 64K in an Apple IIe. If you have an extended 80-column card, all 128K is usable, and if you have RamWorks, up to 1088K is available.

Each Z-80 Plus comes with our CP/M Ram Drive software, enabling IIe owners to use an extended 80-column card or a RamWorks card as a high-speed Ram disk which runs CP/M software up to *twenty times faster*. So packages like WordStar and dBASE II run at blinding speed.

Simply plug the Z-80 Plus into any slot in your Apple. You'll get the benefits of two computers in one — all at an unbelievably low price (only \$139!).

- Fully compatible with ALL CP/M software
- Fully compatible with most hard disks, including Corvus and the Sider
- Fully compatible with Microsoft disks (no pre-boot required)
- Specifically designed for high speed operation in the Apple IIe (runs just as fast in the Apple II + and Franklin)
- Runs WordStar, dBASE II, Turbo Pascal, Fortran-80, Peachtree and ALL other CP/M software with *no pre-boot*
- Semi-custom I.C. and low parts count allows Z-80 Plus to fly through CP/M programs with extremely low power consumption (we use the Z-80B)
- Does EVERYTHING other Z-80 boards do, *plus* Z-80 interrupts
- Five year warranty

Call to order today, 9 a.m. to 11 p.m. seven days, or send check or money order to Applied Engineering. MasterCard, VISA and C.O.D. welcome. Texas residents add 5½% sales tax. Add \$10.00 outside U.S.A.

AE Applied Engineering
P.O. Box 798, Carrollton, TX 75006
(214) 241-6060

Timemaster H.O.TM, the only clock that displays time and date on AppleWorksTM screens and files.

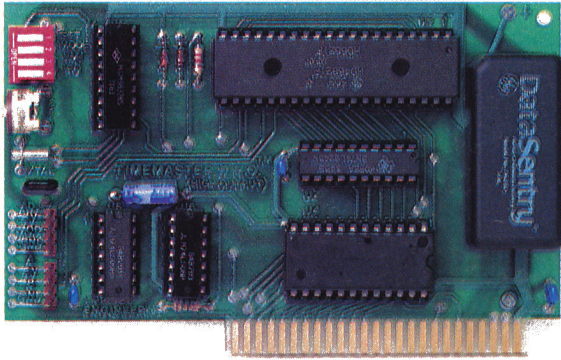

*Now, get all the features of
all the competition combined!*

It's the smart way to put the time and date on your Apple II+[®] or IIe[®]. Because only the Timemaster H.O. packs *ALL* the features of all the competition *combined*, including leap year, year (not just in PRO-DOS), month, date, day of week, hours, minutes, seconds and milliseconds. It's totally PRO-DOS, DOS 3.3, PASCAL and CP/M compatible. And of course, it works better than any other clock with AppleWorks.

If you're using or writing software for other clock cards, you're still covered. Because the H.O. will *automatically* emulate them. And the Timemaster H.O. adds 14 new commands to BASIC. The H.O. even comes complete with two disks full of sample programs, including a computerized appointment book, a DOS dating program, interrupt programs, and over 30 programs that others charge extra for — or don't even offer.

As a low-cost option, you can add true BSR remote control to the H.O., giving you remote control of up to 16 lights and appliances in your home or office.

- Fully PRO-DOS and DOS 3.3, CP/M and PASCAL compatible
- Time in hours, minutes, seconds and milliseconds (the **ONLY** PRO-DOS compatible card with millisecond capability); date with year, month, day of week and leap year
- 24-Hour military format or 12-hour AM/PM format
- Eight software controlled interrupts so you can run two programs at the same time (many examples included)
- Can be set to the second
- Allows AppleWorks to time and date stamp all data automatically
- The only clock card that displays time and date on the AppleWorks screen
- Five-year warranty

Clock price \$129.00
BSR option (may be added later) \$ 49.00

Call to order today, 9 a.m. to 11 p.m. seven days, or send check or money order to Applied Engineering. MasterCard, VISA and C.O.D. welcome. Texas residents add 5½% sales tax. Add \$10.00 outside U.S.A.

AE Applied Engineering
P.O. Box 798, Carrollton, TX 75006
(214) 241-6060

on screen. In one you might type a draft; in another, you might work on a later version.

You can usually enlarge or reduce windows by clicking on and dragging grow boxes. You can shut a window—remove it from the screen—by clicking on a designated area or a special box called a *close box*, which appears in the upper left-hand corner of the window.

Scrolling through long documents or spreadsheets is a joy with a Mac-like program. Instead of executing control- or apple-key sequences to make quantum leaps through your prose or data, you move up and down (or left and right) by dragging the mouse along a vertical (or horizontal) scroll bar. Some programs call the vertical scroll bars *elevators*, an apt metaphor.

Icons

Few Mac-like programs for the Apple II have achieved Level 3 status by offering icons. (On the Macintosh, for example, clicking on a trash can means "Dump this one in the circular file"; the wrist-watch icon means "Please wait.") I'm aware of only three programs—**Mouse Desk** (see Editors' Choice, March 1986, p. 120), **Person-to-Person**, and **Catalyst 3.0**—that have fully met the challenge of simulating the Mac environment. (*Editor's note: Instant Pascal is one Apple product whose Mac and II versions are more than similar. See Jim McKelvey's review on p. 30 for more information on this interesting adaptation of the Macintosh interface.*)

Easier Said Than Done?

One of the hallmarks of the visual interface is its ease of use. In fact, its originators at PARC were trying to design a computer that worked in a more human-like fashion. The result was, if not more human-like, certainly more humane.

Some keyboard-oriented folks (and I was one of them before I converted) may wonder how a mouse can make computing easier. The truth is sometimes it does, sometimes it doesn't.

Take word processing, for example. By its very nature, it requires that you use the keyboard most of the time. If you write first and edit later, you may take to a mouse-driven word processor like a kid to a mud puddle. If you edit as you go along, though, you might find it awkward to move back and forth interminably from keyboard to mouse.

Whether you're processing words or data, the visual interface can simplify your work. It's a cinch to highlight a piece of text you need to move or a section of a spreadsheet you'd like to calculate. In either case, there are no commands to memorize. Instead, once you've highlighted the targeted area by dragging the mouse over it, you move to the appropriate pull-down menu and click on the menu option you want.

One of the nicest features of Mac-like software is

the ease with which it handles disk-housekeeping chores. Saving, loading, formatting, and cataloging are all accomplished with a point and a click.

At one level or another, more and more software is mimicking the Macintosh way of doing things. Although they're untraditional both in appearance and use, these programs nevertheless may be classified according to traditional categories: word processors, spreadsheets, data-base managers, graphics, personal finance, communications, desktop organization, and accessories.

Two Word Processors

Two publishers have taken up the challenge of bringing the Macintosh model to Apple II word processors. MouseWrite from Roger Wagner Publishing (see Editors' Choice, July 1985, p. 112, and March 1986 Reviews, p. 70) and Mouse Word from International Solutions (see Editors' Choice, March 1986, p. 120) are worthy competitors in this field.

MouseWrite works with or without a mouse. If you don't have a mouse, you use the escape, cursor, and return keys to pull down and select from menus. With an apple-key sequence, you can make a mouse pointer appear on screen. Not all features of MouseWrite are available to mouseless users, though, so you're probably better off if you run the program with a mouse. Besides, MouseWrite is more fun that way.

Although it doesn't offer icons, MouseWrite comes very close to being truly Macintosh-like. When you finish typing within the document window, you save your file, then use the close box to wipe the slate clean for a new memo, letter, or report.

Roger Wagner Publishing followed Apple's written guidelines for implementing the Macintosh user interface. These guidelines dictate that a program show all its options on screen. Some users find MouseWrite confusing at first, but that judgment is based solely on appearance. The program is indeed easy to operate.

Mouse Word, created for Version Soft in France and distributed in the U.S. by International Solutions, requires a mouse and 128K. You can run it on an Apple IIe without mouse text, but the result is visually less pleasant. The menu bar mimics most users' writing sequence: From left to right across the screen you find the File, Edit, Format, and Print menus.

Though dissimilar in screen appearance and menu setup, MouseWrite and Mouse Word have similar text-formatting features, such as boldface and underlining. Both programs use embedded commands for page- and print-formatting features.

Each program offers a few extras. MouseWrite includes a clock/calendar for time- and date-stamping documents, and an alarm-clock feature. Mouse Word provides an advanced-function calculator and mail

Viewmaster 80,TM the sharpest 80 column card of them all.

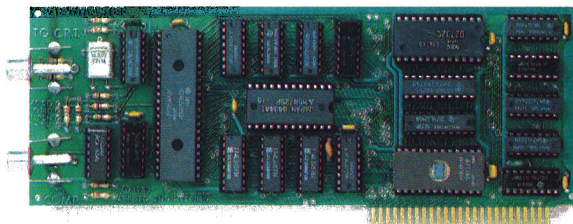

| | HIDDEN SYSTEMS | SOFT KEY SUPPORT | LOW POWER DESIGN | 80 COLUMN BOARD | 7x9 DOT MATRIX | LIGHT PEN INPUT | 80 COLUMN OPERAND | REVERSE CHARACTERS |
|----------------------|-------------------|---------------------|---------------------|--------------------|-------------------|--------------------|----------------------|-----------------------|
| VIEWMASTER 80 | ✓ | ✓ | ✓ | ✓ | ✓ | ✓ | ✓ | ✓ |
| SUPRTERM | | ✓ | | | | | ✓ | ✓ |
| WIZARD 80 | | | | | ✓ | | ✓ | ✓ |
| VISION 80 | ✓ | ✓ | | | ✓ | | | |
| OMNIVISION | | ✓ | | | | | ✓ | ✓ |
| VIEWMAX 80 | ✓ | ✓ | | | ✓ | | | ✓ |
| SMARTERM | ✓ | ✓ | | | | ✓ | ✓ | |
| VIDEOTERM | | ✓ | ✓ | | ✓ | ✓ | | ✓ |

Now, get great resolution and total software compatibility for your Apple II[®] or II+[®]

One look at the chart will give you some of the reasons there's only one smart choice in 80 column cards for your Apple. But the real secret to Viewmaster 80's success is something even better: Total compatibility.

The Viewmaster 80 works with all 80 column applications, including DOS 3.3, PRO-DOS, CP/M, Pascal, WordStar, Format II, Easywriter, Applewriter II, Supertext 80, Zardax, Apple PI, Letter Perfect, dBASE II, Visicalc, Multiplan, and *hundreds* of others.

And the Viewmaster 80 delivers a super sharp, state-of-the-art display with a 7x9 character matrix for clear, easily readable characters. Here are just a few of the powerful features the Viewmaster 80 delivers for a great price (\$139):

- 80 Characters by 24 lines
- Fully compatible with all Apple languages and software
- Super sharp 7x9 character matrix with true descenders
- Highest compatibility with existing 80 column software
- Power and input connector for light pen
- Very low power consumption
- High speed (18 MHz) scroll rate
- Upper and lower case characters with true descenders, both inverse and normal; all on-screen editing functions are supported
- User-definable cursor shape
- Compatible with Apple II, II+ and IIe
- Five year warranty

Call to order today, 9 a.m. to 11 p.m. seven days, or send check or money order to Applied Engineering. MasterCard, VISA and C.O.D. welcome. Texas residents add 5½% sales tax. Add \$10.00 outside U.S.A.

AE Applied Engineering
P.O. Box 798, Carrollton, TX 75066
(214) 241-6060

UPGRADE your Apple II or II+ Keyboard with the REPEATERRRR™

SPEED UP VISICALC
WORD PROCESSING PROGRAM EDITING

Auto Repeat: repeats any keypress.

On-Off Adjustable Delay: to match your typing touch.

High-Speed Cursor: Makes REPT key a speed control to double the repeat rate of any keypress.

Shift-Key Modification: Get standard upper-lower case shifting. Supported by most popular word processors and many other programs. Leaves game I/O open.

Easy Installation: Fits Rev 7 or later and works with most 80 column boards. No soldering.

REPEATERRRR™ without SHIFT-Key Modification **\$37⁹⁵**

REPEATERRRR+™ with SHIFT-Key Modification **\$47⁹⁵**

TO ORDER:

Call or write H.O.M.E. or ask your local dealer. Add \$2 per order shipping/handling (\$5 foreign). Ohio orders add 6.5% sales tax. Prepay with check, Master Card, VISA (include card number and expiration date). 30-day trial - full refund if not satisfied. One year warranty.



HIGH ORDER MICRO ELECTRONICS CORP.

17 River Street, Chagrin Falls, Ohio 44022 (216) 247-3110

Trademarks: Apple/Apple Computer, Inc. VisiCalc/VisiCorp.

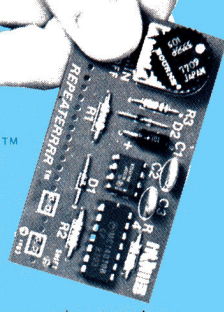

Circle 229 on Reader Service Card.

SUPER RAM POWER LEGEND S'CARD™

ENJOY APPLEWORKS ON II AND II+
by upgrading with Legend S' Card

EXPAND APPLEWORKS DESKTOP
up to 1024K

FASTER LOADING OF PROGRAMS
with High Speed Disk Emulation compatible with ProDOS, DOS,
CP/M, Pascal and SOS

APPLE II, II+, IIe, III COMPATIBLE
for use in virtually any expansion slot

Get a Truckload of Software, Service,
Support and a Three-Year Warranty with
Legend S'Card

LEGEND INDUSTRIES, LTD.

2220 Scott Lake Road, Pontiac, MI 48054
(313) 674-0953

Turning Apples into Legends™ since 1981

Legend and S'Card are trademarks of Legend Industries, Ltd.
Apple and AppleWorks are trademarks of Apple Computer, Inc.

merging, as well as built-in communications utilities for going on line.

Both programs work with a wide variety of popular dot-matrix and letter-quality printers. Both support Apple's high-capacity microfloppy drive, the UniDisk 3.5.

MouseWrite is noncopy-protected and is easily installed on a hard-disk drive. Mouse Word is not copyable.

A Mac-Style Spreadsheet

At this writing, only **Mouse Calc** from International Solutions (see Editors' Choice, March 1986, p. 120) is available to those ready to take one giant step toward Mac-like spreadsheeting. Pull-down menus with myriad filing, formatting, and calculation options replace the slash commands VisiCalc users could count instead of sheep.

With Mouse Calc there's no need to memorize commands or designate cell ranges by their coordinates. Instead of typing @SUM(A34..A56), for instance, all you have to do is drag the mouse over that range to highlight it. Then you move the mouse up and select Sum from the Function menu.

Mouse Calc's printing capabilities are notable. Not only can you print the spreadsheet in VisiCalc style, but you can also print it as it appears on screen, complete with grid lines.

A real bonus—one I hope becomes standard for Mac-like spreadsheets to come—is Mouse Calc's built-in graphics feature. Having defined a range of cells to be charted, you open a window. With a click of the mouse button, a graph appears on screen in double hi-res color. Graphs can take a variety of forms—standard, three-dimensional, bar, or line. All are easy to print.

Mouse Calc is compatible with VisiCalc and AppleWorks spreadsheet files, and you can incorporate Mouse Calc spreadsheets into Mouse Word word-processed documents.

A Data-Base Program to Come

At press time, International Solutions was working on **Mouse File**, a page-oriented data-base program offering some graphics features. The publisher claims that Mouse File resembles FileMaker, a Macintosh data-base program. Mouse File is expected to be released during the first half of 1986.

Dazzling Graphics

In the Mac-style graphics realm, no name stands out better than that of Broderbund Software. Both Dazzle Draw (see *inCider's* review on p. 87 in the June 1985 issue) and Fantavision (see Editors' Choice, February 1986, p. 120) are revolutionary, as well as evolutionary, programs.

Dazzle Draw is an easy-to-use, easy-to-lose-yourself-in double hi-res drawing program. You can use a joystick instead of a mouse, but I think the mouse

is easier to control—not to mention more fun.

There are so many colors, patterns, brushes, and other “tools” to work with that even the least creative individual will soon find Dazzle Draw enchanting.

You might think a mouse would be cumbersome for fine drawing, that a pen of one kind or another would be more precise. That would be the case were it not for Dazzle Draw’s Zoom feature, which zeros in for a closeup of selected areas of your drawing. Wherever you choose, you can paint pixel by pixel. When you “unzoom,” you may not recognize that detailed masterpiece as your own. You can also create self-booting slide shows to share your artistic talents with friends.

Broderbund’s newer—and no less exciting—release, **Fantavision**, brings animated color graphics to the Apple II. Like Dazzle Draw, Fantavision has pull-down menus and supports the mouse, though you can use a joystick or graphics tablet instead. Like the slide-show feature in Dazzle Draw, Fantavision lets you design self-booting movies.

Personal Finance

Timeworks’ **Your Personal Financial Planner** (volume 1 in the Sylvia Porter series) doesn’t respond to mouse input, but it does offer pull-down menus. In addition, the program provides a couple of desktop accessories—a calculator and memo pad. Thorough, detailed, and fully documented, Personal Financial Planner is much more than a household-budget maker. You can customize the program and prepare long-term financial plans, the kind for which you might pay a consultant hundreds of dollars.

Mouse Budget, from International Solutions (see Editors’ Choice, March 1986, p. 120), is mouse driven and much more Mac-like. As its name implies, Mouse Budget limits itself to budgeting, though it does prepare a variety of reports, such as income and net-worth statements. As in other International Solutions offerings, the menu bar is simple but sufficient: File, Edit, Transactions, Reports, and Set Up are the titles included.

Unfortunately, no one has come up with a way to eliminate the drudgery of typing in the many transactions in which we engage on a daily or monthly basis. Will some clever programmer soon teach a mouse to read receipts and write checks?

Communications and Desktops

Person-to-Person from Trutech Software is an integrated communications program centered around an on-screen Rolodex-type file. In addition, Person-to-Person offers word-processing and telecommunications capabilities. On-screen graphics take you through the program with pull-down menus, windows, and icons, including tabbed and alphabetized

What Is The Most Popular Printer Interface For Apple[®] Computers ?

(Turn page for the answer.)

index-card dividers, and telephone, printer, card, notepad, and satellite-dish icons.

International Solutions’ **Mouse Desk** (which you can use without a mouse) patterns itself on the Macintosh desktop, with pull-down menus, windows, and elevators. Icons complete the metaphor and signify different file types and storage media (floppy disk, 3½-inch disk, or ProFile hard disk)—and Mouse Desk includes a trash can, of course.

In addition to desktop organization, Mouse Desk provides program selection, letting you load Mouse Calc or Mouse Word from a peripheral device.

A second program launcher is Quark’s **Catalyst 3.0**, a mouse-driven, Mac-like utility that transfers ProDOS applications to Apple’s UniDisk 3.5 or a hard-disk drive. Priced separately at \$99, Catalyst 3.0 also comes bundled with the UniDisk 3.5 (\$529 for the //c model; \$599 for the //e version, which includes an interface card).

While some of the programs described here include a desktop accessory here or there, only one program I’m aware of gives you a whole array of accessories in one place—**Pinpoint**, from Pinpoint Publishing (formerly Virtual Combinatics).

Pinpoint is a pioneer Apple II program offering such desk accessories as an appointment calendar, calculator, communications module, phone dialer,



Hints and Techniques~ inCider's Best

Creative Apple II Utilities On One Disk!

Expand your productivity and bolster your Apple II* power with over two dozen top-notch utilities from **inCider** Magazine's "Hints and Techniques" column.

In just minutes, you and your Apple II will accomplish more tasks than ever before—productivity that until now you've only dreamed of! And you'll do it all with one high-quality disk!

inCider Favorites That Give You The Edge!

The **hotCider** March edition helps you do everything from setting the control codes on your printer to keeping track of all the files on all your ProDOS disks.

"Hints and Techniques—inCider's Best" features such great favorites as:

- **Peek to Poke**—convert machine language subroutines and shape tables into Applesoft BASIC.
- **Ditto**—Apple Writer word processing language that lets you **automatically** print multiple copies of your documents.
- **Multiprogrammer**—now you can have three BASIC programs in memory at the same time... ideal for program development and subroutine testing.
- **Ampersand Number Converter**—you've never used a more convenient DEC-HEX converter than this one!

Greater Productivity is Easy!

And that's just for starters—you'll get nearly two dozen **more** great **inCider** utilities! And with **hotCider's** ready-to-run format and easy-to-read documentation booklet, creative productivity has never been easier. No more time-consuming references to back-issues, and no more painstaking do-it-yourself keyboarding and debugging.

Expand your productivity and your Apple II by expanding your software library today. Simply return the coupon or attached order card, or call **TOLL FREE, 1-800-258-5473**. (In NH, dial 1-924-9471).

* Apple II is a registered trademark of Apple Computer Inc.

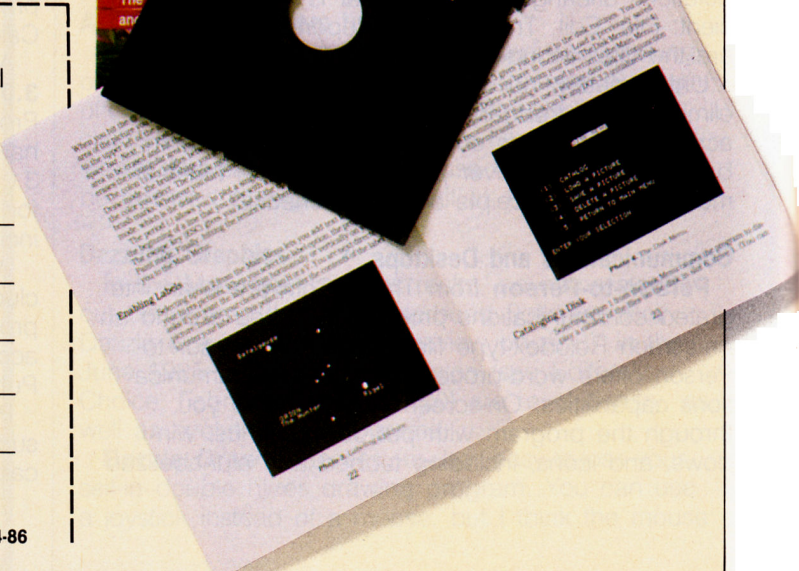
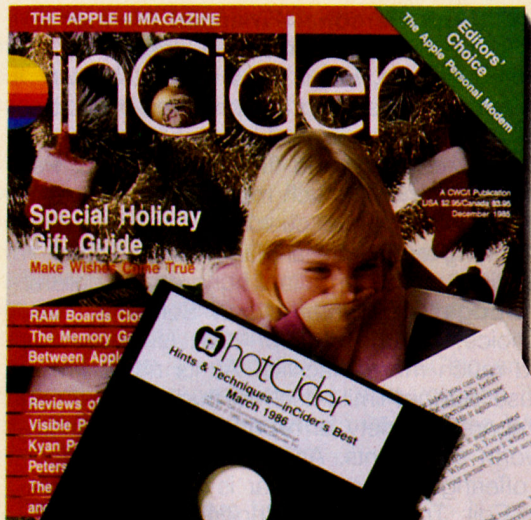

YES! I want more productivity!
Please send me **hotCider's** special new edition** at \$29.97 ea.

Payment Enclosed VISA AE MC

Card # _____ Exp. Date _____

Signature _____

Name _____

Address _____

City _____ State _____ Zip _____

** Available in March 1986

GraphMerge (compatible with Dazzle Draw), notepad, QuickLabel, and typewriter functions.

While you can use Pinpoint as a stand-alone program, it was designed to be an AppleWorks enhancement. Pinpoint is memory resident; its features appear as pop-up windows when you call them. Its accessories respond to the same commands AppleWorks' do. Although Pinpoint has pull-down menus, it's not currently mouse driven.

Conclusion

The transition from keyboard-intensive to mouse-driven software for the Apple II has begun. The publishers discussed in this report have experimented with various aspects of the Macintosh environment. Some have stepped meekly in that direction; some more boldly. Whatever their individual styles, the programs featured here represent an evolution bringing us closer to a unique vision of the best way in which people and computers can work together. ■

Write to Cynthia Field at 10 Border Avenue, Wakefield, RI 02879.

Grappler®

Printer Interfaces

Apple IIe with ImageWriter™ II

Serial Grappler + Color screen dumps and optional buffering at an attractive price.

Apple IIe with Parallel Printers

Grappler + /Buffered Grappler + The industry standard with graphic screen dumps, buffering, text formatting and much more.

Orange Interface Ideal economy interface for letter quality or heavy text applications. Fifteen text commands.

Apple IIc with Parallel Printers

Grappler C The total interface solution, with built-in ImageWriter emulation and graphics screen dump utilities.

Hotlink Low cost serial-to-parallel converter. Works for most applications.

With over 300,000 units sold, the Grappler has been the industry's favorite interface solution. Go with the winner. Go Grappler!

 **Orange Micro®**
inc.
1400 N. Lakeview Ave., Anaheim, CA 92807
(714) 779-2772

Circle 120 on Reader Service Card.

Product Information

A + Mouse

Mouse Systems
2336 H Walsh Avenue
Santa Clara, CA 95051
(408) 988-0211
\$99

Reader Service Number 306

AppleMouse and AppleMouse IIe

Apple Computer
20525 Mariani Avenue
Cupertino, CA 95014
(408) 996-1010
\$100 (AppleMouse)
\$150 (AppleMouse IIe with interface)

Reader Service Number 307

Bank Street Writer

Broderbund Software
17 Paul Drive
San Rafael, CA 94903
(415) 479-1170
\$69.95

Reader Service Number 308

Catalyst 3.0

Quark Peripherals
2525 West Evans
Suite 220
Denver, CO 80219
(303) 934-2211
\$99 (bundled with Apple UniDisk 3.5, \$529, IIc model; \$599, IIe model)

Reader Service Number 309

Cat 'n' Mouse

Mindplay
82 Montvale Avenue
Stoneham, MA 02180
(617) 438-5820
\$39.99

Reader Service Number 310

Dazzle Draw

Broderbund Software
\$59.95

Reader Service Number 311

European Nations and Locations

DesignWare
185 Berry Street
San Francisco, CA 94107
(415) 546-1866
\$44.95

Reader Service Number 312

Fantavision

Broderbund Software
\$49.95

Reader Service Number 313

Mouse Budget, Mouse Calc, Mouse Desk, Mouse Word

International Solutions
Version Soft Service Center
910 West Maude Avenue
Sunnyvale, CA 94086
(408) 773-0443
\$69.95 (Budget),
\$149.95 (Calc),
\$39.95 (copy-protected Desk),
\$69.95 (noncopy-protected Desk), \$129.95 (Word)

Reader Service Number 314

MouseWrite

Roger Wagner Publishing
10761 Woodside Avenue
Suite E
Santee, CA 92071
(619) 562-3670
\$125

Reader Service Number 315

Person-to-Person

Trutech Software
1700 Solano Avenue
Berkeley, CA 94707
(415) 525-4901
\$100, \$150 (noncopy-protected)

Reader Service Number 316

Pinpoint

Pinpoint Publishing
2823 Steinmetz Way
Oakland, CA 94661
(415) 530-1726, \$69

Reader Service Number 317

Print Shop Companion

Broderbund Software
\$39.95

Reader Service Number 318

ProCom-A Communications Software

Prometheus Products
4545 Cushing Parkway
Fremont, CA 94538
(415) 490-2370 \$49

Reader Service Number 319

StickyBear SpellGrabber

Weekly Reader Family Software/Field Publications
245 Long Hill Road
Middletown, CT 06457
(203) 638-2400
\$39.95

Reader Service Number 320

Your Personal Financial Planner

Timeworks
444 Lake Cook Road
Deerfield, IL 60015
(312) 948-9200
\$99.95

Reader Service Number 321

SILICON EXPRESS DISKS
SS/IDD 9.95
DS/IDD 10.95

VERBATIM OR MAXELL
SS/IDD 14.45
DS/IDD 18.45

ELEPHANT
SS/IDD 11.95
DS/IDD 16.45

DATA CASE
8.99

SILICON EXPRESS

ALL NEW STORE WITH EXPANDED WAREHOUSE

INSIDE OHIO
1-800-225-0755
YOUR TOLL FREE ACCESS OUTSIDE OHIO
1-800-228-0755
CALL...FOR THE BEST PRICES...
BEST DELIVERY...
We have hundreds of other programs in stock at Fantastic savings.

| | | | |
|-----------------------|--------|-----------------------|--------|
| Adventure Const. | 30.75 | Facemaker | 17.95 |
| Algebaster | 34.95 | Family Roots | 149.95 |
| Algebra I thru IV ea. | 28.95 | Fantavision | 31.95 |
| Algebra V & VI | 34.95 | Farenheit 451 | 27.49 |
| Alphabet Zoo | 18.95 | Fat Cat | 19.00 |
| Alpha Plot | 24.89 | Fighter Command | 41.95 |
| A Mind Forever Voy. | 30.95 | Financial Cookbook | 31.00 |
| Archon I or II | 22.45 | Flex Type | 16.00 |
| ASC II Express | 75.00 | Flight Sim. II | 33.89 |
| Assembly Lines Bk. | 16.95 | Fontrix | 54.00 |
| Back-it-up III | 42.00 | Ftpaks 1 thru 13 ea. | 13.00 |
| Bag of Tricks #2 | 34.95 | Forecast | 36.00 |
| Ball Blazer | 27.95 | Font Mechanic | 19.95 |
| Bank Street Filer | 39.95 | Fraction Factory | 18.99 |
| Bank Street Mailer | 39.95 | Fraction Fever | 17.95 |
| Bank Street Writer | 39.95 | Frame-Up | 16.50 |
| Bank Street Speller | 39.95 | Game Maker | 34.95 |
| Bard's Tale | 28.50 | Gato | 22.75 |
| Baron | 23.75 | Geopolitique 1990 | 25.89 |
| Beagle Bag | 18.49 | Gertrude's Puzzles | 25.00 |
| Beagle Basis | 19.00 | Gertrude's Secrets | 25.00 |
| Beagle Graphics | 31.00 | Ghostbusters | 23.50 |
| Beneath Apple DOS | 13.95 | GI Joe | 21.95 |
| Bnth. Apl. Pro DOS | 13.95 | Goren Bridge | 51.95 |
| Big U | 22.95 | Graphics Department | 62.00 |
| Black's Law Dict. | 69.95 | Graphics Expander | 27.95 |
| Blazing paddles | 27.00 | Graphworks | 63.95 |
| Bookends | 67.00 | GPLE | 26.69 |
| Bookends Extended | 104.95 | Guadalcanal | 41.95 |
| Borrowed Time | 27.95 | Hacker | 27.95 |
| Breakthru Ardennes | 41.95 | Handlers Package | 95.00 |
| Carmen Sandiego | 23.75 | Hey Diddle Diddle | 17.95 |
| Carriers at War | 30.75 | Hitchhiker's Guide | 22.00 |
| Captain Goodnight | 24.95 | Home Accountant | 47.95 |
| Cat Graphics | 20.95 | Homework | 41.00 |
| Chshp. Load Runner | 20.00 | Homework Filer | 41.00 |
| Chart 'n Graph Tlxb. | 23.95 | Homework Speller | 30.00 |
| Chop Lifter | 20.00 | Image Printer II | 34.95 |
| Clip Art Vol. 1 | 19.99 | Impossible Mission | 24.95 |
| Complete Graphics | 47.89 | Infidel | 26.00 |
| Computer Ambush | 41.95 | I.O. Silver | 16.75 |
| Computer Baseball | 25.89 | Jeeves | 29.95 |
| Computer Qtrbck. | 27.95 | Juggle's Rainbow | 18.95 |
| Copy II - | 18.95 | Kamfrupe | 41.95 |
| Coveted Mirror | 20.89 | Karateka | 20.00 |
| Crossword Magic | 30.00 | Kids on Keys | 17.95 |
| Crypt of Medea | 21.95 | Kid Writer | 18.89 |
| Cut & Paste | 23.00 | Kinder Comp | 17.95 |
| Cutthroats | 23.69 | Knight of Diamonds | 20.75 |
| Database Toolbox | 23.95 | Knights of the Desert | 27.95 |
| Dazzle Draw | 35.00 | King's Quest I or II | 29.95 |
| D-Code | 22.00 | Koronis Rift | 27.95 |
| Deadline | 28.00 | Legacy of Lyllygamy | 23.75 |
| Delta Drawing | 27.95 | Lisa 2.6 Assembler | 53.00 |
| DiskQuick | 16.00 | List Handler | 44.00 |
| Dollars & Sense | 67.00 | Little Comp. People | 27.95 |
| DOS Boss | 13.00 | Locksmith | 64.00 |
| Double-Take | 19.00 | Lode Runner | 20.00 |
| Dragonworld | 23.00 | Magic Paint Brush | 24.95 |
| Eagles | 27.95 | Magic Spells | 20.75 |
| Early Games | 19.95 | Mag. Window II or IIE | 93.89 |
| Eidolon | 27.95 | Make a Match | 20.95 |
| Enchanter | 22.00 | Man. Your Money | 104.95 |
| Essential Data Dup | 43.50 | Mask of the Sun | 27.75 |
| Essex | 30.95 | Mask Parade | 27.95 |
| Europe Ablaze | 30.75 | Mastering the GRE | 69.95 |
| Expedition Amazon | 21.89 | Mastering the SAT | 69.95 |
| Extra K | 22.00 | Mas. of the Lamps | 21.95 |
| F-15 Strike Eagle | 20.75 | Master Type | 24.89 |
| | | Math Blaster | 27.50 |
| | | Math Maze | 27.95 |
| | | Medical Dictionary | 69.95 |

| | | | |
|------------------------|--------|-----------------------|--------|
| Megaworks | 84.95 | Silicon Salad | 13.50 |
| Merlin | 34.00 | Skyfox | 24.50 |
| Merlin Pro | 56.00 | Snooper Trip I or 2 | 22.95 |
| Merlin Combo | 63.95 | Solo Flight | 34.95 |
| Micro Cookbook | 22.25 | Sorcerer | 28.00 |
| Micro Lg. Baseball | 23.75 | Speed Reader II | 38.50 |
| Millionaire | 23.75 | Spell Breaker | 34.95 |
| Minipix #1 | 13.89 | Spell Copter | 23.99 |
| Mouse Budget | 48.95 | Spell II | 27.50 |
| Mouse Calc | 104.95 | Spellworks | 34.95 |
| Mouse Desk | 27.95 | Spyfire Simulator | 24.75 |
| Mouse World | 90.95 | Spy vs. Spy | 26.00 |
| MouseWrite | 72.00 | Spy vs. Spy | 24.95 |
| Most Amazing Thing | 22.95 | Starcross | 23.75 |
| Multi Disk Catalog | 17.95 | Star Lg. Baseball | 28.00 |
| Multiplan DOS 3.3 | 65.95 | Star Lg. Baseball | 20.95 |
| Munch-A-Bug | 23.95 | Star Trek | 31.95 |
| Murder by the Dozen | 21.99 | Slicky Bear ABC | 23.75 |
| Music Construction | 24.75 | Basket Bounce | 23.75 |
| NATO Commander | 21.75 | BOP | 23.99 |
| Net Worth | 48.89 | Car Builder | 23.75 |
| Newsroom | 34.95 | Math | 23.75 |
| One-On-One | 24.50 | Numbers | 23.75 |
| Paper Graphics | 30.89 | Opposites | 23.75 |
| PFS: Access | 44.00 | Reading | 23.75 |
| PFS: Write | 69.95 | Shapes | 23.75 |
| PFS: File | 69.95 | Spellgrabber | 23.75 |
| PFS: Plan | 69.95 | Town Builder | 23.75 |
| PFS: Report | 69.95 | Typing | 23.75 |
| PFS: Graph | 69.95 | Story Machine | 17.95 |
| PFS: First Success | 159.95 | Story Maker | 24.95 |
| Phantasia | 27.95 | Sum Games I or II | 23.75 |
| Piece of Cake Math | 21.95 | SuperCalc 3A | 109.95 |
| Picture Builder | 23.99 | SuperDisk Copy | 24.95 |
| Pinball Construction | 21.50 | Suspect | 26.00 |
| Pinpoint | 39.95 | Suspended | 28.00 |
| Pitstop II | 27.95 | Sword of Kadesh | 24.95 |
| Pixit | 31.89 | Take 1 | 34.00 |
| Planetfall | 22.00 | Technical Dictionary | 41.95 |
| Practicalc II | 48.95 | Temple of Apshai Tri. | 27.95 |
| Prince | 48.95 | Terrain Logo | 59.95 |
| Printographer | 23.95 | Think Tank | 88.89 |
| Print Shop | 27.00 | Time is Money | 58.00 |
| Pr. Shp. Gr. #1.2 or 3 | 14.50 | Tip Disk #1 | 13.89 |
| Print Shp. Companion | 24.95 | Trains | 20.95 |
| Print Shop Refill | 13.95 | Texas | 21.89 |
| Probyter | 19.25 | Triple-Dump | 21.50 |
| Prof. tour golf | 25.89 | Turbo Pascal 3.0 | 35.95 |
| Pronto DOS | 16.25 | Turbo Database Tlxb | 29.95 |
| Quest | 21.89 | Turbo Tutor | 20.75 |
| Quicken | 51.95 | | |
| Rambo | 41.95 | | |
| RDF | 24.95 | | |
| Reach for the Stars | 28.50 | | |
| Reader Rabbit | 25.95 | | |
| Reformer '88 | 41.95 | | |
| Rendezvous w/Rama | 23.00 | | |
| Report Card | 33.00 | | |
| Report Works | 84.95 | | |
| Rescue on Fractalus | 27.95 | | |
| Rescue Raiders | 24.95 | | |
| Rhymes & Riddles | 17.95 | | |
| Robot Odyssey I | 28.00 | | |
| Rocky's Boots | 28.00 | | |
| Sargon III | 27.50 | | |
| Sat (Harcort Brace) | 46.99 | | |
| Science Tool Kit | 41.95 | | |
| Seastalker | 22.00 | | |
| Sensible Grammar | 64.95 | | |
| Sensible Speller | 64.95 | | |
| Serpent's Star | 27.95 | | |
| 7 Cities of Gold | 24.50 | | |
| Shadowkeep | 23.00 | | |
| Shape Mechanic | 26.95 | | |
| Sideways | 33.00 | | |

| | | | |
|----------------------|--------|------------------------|--------|
| Tycoon | 23.75 | Mach III II - Joystick | 32.50 |
| Typefaces | 10.95 | Mach III IIE Joystick | 32.50 |
| Typing Tutor III | 29.75 | Micromodem IIE | 139.95 |
| Ultima II | 41.95 | Microsci A2 Drive | 149.95 |
| Ultima III | 33.69 | Microsci IIC Drive | 154.95 |
| Ultima IV | 41.95 | Mockingboard A | 67.00 |
| Understanding IIE | 17.95 | Mockingboard B | 67.00 |
| Understanding II - | 15.95 | Mockingboard C | 119.00 |
| Universal file conv | 24.00 | Mockingboard D | 129.00 |
| Utility City | 16.25 | Mockingboard A-MAX | 39.95 |
| Versaform | 44.00 | Multiram CX (16 bit) | CALL |
| Video Toolbox | 23.95 | Multiram IIX (16 bit) | 154.95 |
| Visable 6502 | 21.95 | Multiram IIC 256k | 319.95 |
| War in Russia | 51.89 | Multiram IIE 80/64K | 129.95 |
| Wilderness | 38.95 | Multiram IIE 80/152 | 209.95 |
| Will Writer | 31.95 | Multiram IIE 80/768 | 249.95 |
| Winter Games | 27.95 | Multiview II - 80/160 | 215.00 |
| Wishbringer | 27.95 | Muppet Pad | 43.99 |
| Wizard | 20.00 | Paddlesicks | 26.50 |
| Wizardry | 29.00 | Parallel Printer Card | 54.95 |
| Wizard's Toolbox | 23.95 | Peach | 41.95 |
| Wizprint | 15.99 | Print-It | 128.00 |
| Word Attack | 27.50 | Prometheus 1200A | 288.99 |
| Word Handler | 44.00 | Super Serial Card | 103.95 |
| Word Perfect | 125.95 | System Saver Fan | 59.95 |
| Word Spinner | 23.95 | Thunder Clock | 104.00 |
| World's Great. Bball | 27.95 | Ultraterm | 244.89 |
| World's Great. Ftbl | 26.95 | Videoterm | 177.95 |
| Write Choice | 22.00 | Wildcard 2 | 74.95 |
| Zork I | 22.00 | ZEE 00A Checkmate | 69.95 |
| Zork II or III | 25.00 | Zoom IIE | 114.00 |

| | | | |
|----------------------|--------|----------------------|--------|
| HARDWARE | | PRINTERS | |
| 80 Col. 64K Card | 64.95 | Star SG-10 | 219.00 |
| Apple Cat II | 187.00 | Star SG-15 | 394.99 |
| Apple Cat 212 | 353.00 | Star SD-10 | 344.99 |
| Compuserve Starter | 21.95 | Star SD-15 | 474.99 |
| Datasec | 8.99 | Star SR-10 | 494.99 |
| Disk Notcher | 8.99 | Star SR-15 | 584.99 |
| Echo | 104.95 | Star Powertype | 344.95 |
| Flip-n-File | 14.95 | Okidata 182 | 239.95 |
| Gibson Light Pen | 148.00 | Okidata 20 | 209.95 |
| Grappler Buffered | 133.00 | Okidata 192P | 399.95 |
| Grappler (serial) | 73.00 | Daisywriter 2000 | 684.95 |
| Grappler C | 73.95 | Juki 6100 | 424.95 |
| Hoflink | 54.99 | Colored Printer Rbns | CALL |
| Keytronics Keybd. | 199.95 | Color Paper Pack | 13.95 |
| Koala Pad | 71.00 | MONITORS | |
| Kraft Joystick | 26.00 | Amdck Color 300 | 199.95 |
| Lemon | 31.95 | Amdck Color 500 | 339.99 |
| Lime | 48.95 | Amdck Color 600 | 414.99 |
| Mach II - Joystick | 26.50 | Amdck Video 300G | 127.99 |
| Mach II IIE Joystick | 26.50 | Amdck Video 300A | 137.99 |

YOUR ORDER FORM
SILICON EXPRESS

5955 E. Main Street Columbus, Ohio 43213

NAME _____
ADDRESS _____
CITY _____ STATE _____ ZIP _____
CHARGE CARD # _____ Exp. Date _____

| QTY. | DESCRIPTION | PRICE |
|------|-------------|-------|
| | | |
| | | |
| | | |
| | | |
| | | |

Computer Type _____ SHIPPING _____
Phone No. _____ TOTAL _____

No additional surcharge on Mastercard, Visa, or School purchase orders. Personal checks allow 2 weeks. Shipping charges are \$2.50 minimum. Ohio residents add 5 1/2% state sales tax. Prices subject to change without notice.

SILICON EXPRESS

5955 E. Main St. Columbus, Ohio 43213
1-614-868-6868



THE AMING OF THE SCREEN

by Bill O'Brien

*Give your
Applesoft programs
Mac-like
screen options.*

Demarest

Macintosh-like software may be fine for the new Apple owner who hasn't already invested time and energy writing and debugging his or her own customized software. But what about the person who *has* spent hours and days nursing a program along until it's just right? Will he or she be forced to abandon it just to experience an environment similar to the Macintosh's?

The answer is a flat *no* if that person owns an Apple IIc or an enhanced Apple IIe. Since its introduction, quite a few changes have occurred in the II series. Among them, the new and upgraded machines' "enhanced" video firmware permits a higher degree of screen control. The mouse-text characters included in this enhanced firmware give you more than letters and numbers to control.

HAVING TROUBLE REMEMBERING ALL THE
COMMANDS FOR YOUR PROGRAMS??

YOU NEED

LEROY'S CHEATSHEET®

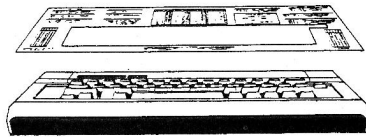

KEYBOARD OVERLAYS FOR THE

Apple® IIe & IIc

THE QUICK AND EASY SOFTWARE DOCUMENTATION

Forget about constantly referring back to the manual for operating commands. Discover all the "special" commands buried in the manuals. LEROY'S CHEATSHEETS are sturdy plastic laminated help sheets designed for use with popular software, hardware and languages for APPLE IIe & IIc computers. Commands are grouped together for logical use. You learn and use your programs faster and easier.

only
\$5.95
each

IIe Cheatsheets are DIE CUT overlays designed to fit over the keyboard

IIc Cheatsheets are 7 x 10% reversible plastic laminated reference cards

With LEROY'S CHEATSHEETS you will never have to hunt for a command again.

WORD PROCESSORS

APPLE WRITER II ProDOS
SCREENWRITER II
SPEEDSCRIPT (COMPUTE!)

PRINTERS

EPSON RX & FX 80 & 100
GEMINI 10X & 15X
IMAGEWRITER
OKIDATA MICROLINE 92 & 93

MISCELLANEOUS

BLANKS (SET OF 3)
FLIGHT SIMULATOR II
FOR THE BEGINNER (DOS 3.3)
GRAPPLER + / PRINT WORKSHOP

BUSINESS

APPLEWORKS
MULTIPLAN
PRACTICALC II
SUPERBASE
VISICALC

LANGUAGES

BASIC (DOS 3.3)
LOGO (APPLE)
LOGO (TERRAPIN)
BASIC (PRODOS)

MORE DESIGNS ON THE WAY
CIRCLE YOUR CHOICES

IIe (overlay) IIc (card)

QTY. _____ X \$ 5.95 = \$ _____

* SHIPPING \$ 1.00*

U.S. & CANADA \$1.00 6% TAX \$ _____
FOREIGN ORDERS \$3.00 TAX ONLY

CHECK, M.O., MC/VISA
U.S. FUNDS NO C.O.D. TOTAL \$ _____

MC/VISA # _____

EXPIRATION DATE _____

NAME _____

ADDRESS _____

CITY _____

STATE _____ ZIP _____

CHEATSHEET PRODUCTS INC.
P.O. Box 111969 Pgh., PA 15238
(412) 781-1551 cid r 2



Table. Screen-control codes.

| Control Character | ASCII Code | Apple II/c Name | Result |
|-------------------|------------|--------------------|--|
| Control-G | 7 | Bell | Sounds the Apple's bell for 0.1 seconds. |
| Control-H | 8 | Backspace | Moves cursor one space to the left. If that would exceed the left edge of the window, the cursor is moved to the rightmost position on the line above. |
| Control-J | 10 | Linefeed | Moves cursor down one line, and scrolls screen if necessary. |
| Control-K | 11 | Clear EOS | Clears from the cursor position to the end of the screen. |
| Control-L | 12 | Home and clear | Moves cursor to upper left-hand corner of the window and clears the window. |
| Control-M | 13 | Return | Moves cursor to the left edge of the next line in window and scrolls if necessary. |
| Control-N | 14 | Normal | Sets display format to normal. |
| Control-O | 15 | Inverse | Sets display format to inverse. |
| Control-Q | 17 | 40-column | Sets display to 40-column mode. |
| Control-R | 18 | 80-column | Sets display to 80-column mode. |
| Control-U | 21 | Quit | Deactivates enhanced video firmware. |
| Control-V | 22 | Scroll | Scrolls the display down one line while leaving the cursor at the same position. |
| Control-W | 23 | Scroll-up | Scrolls the display up one line while leaving the cursor at the same position. |
| Control-X | 24 | Disable mouse text | Disables mouse-text character display and uses inverse video instead. |
| Control-Y | 25 | Home | Moves cursor to upper left-hand corner of window (does not clear the screen). |
| Control-Z | 26 | Clear line | Clears entire line containing the cursor. |
| Control-[| 27 | Enable mouse text | Disables inverse characters and displays mouse text instead. |
| Control-\ | 28 | Fwd. space | Moves cursor one space to the right. If that move exceeds the right edge of the window, the cursor is placed on the left side of the next line. |
| Control-] | 29 | Clear EOL | Clears the line beginning at the current cursor position up to the right edge of the window. |
| Control-^ | 31 | Up | Moves cursor up one line. |

Note that, with the exception of the first, second, third, and fifth codes, enhanced video firmware must be activated.

Programming the Screen

Before you look at mouse text, try playing with the screen itself. Almost all Apple owners are aware of the ESC commands to move the cursor and clear the screen. The only problem is that these are keyboard-activated commands. They're helpful if you're editing a program, but you can't reach them from within the program itself.

The enhanced text-handling routines in the IIc and IIe let you activate control codes from within a program (see the **Table**). Notice the wording used to describe the results of some of those controls: They affect the Apple's window, not the screen—an important distinction.

Doing Windows

Apple screen size is malleable, but I've rarely seen that feature used to any real extent. The process is simple enough, being composed of only four POKE commands:

```
POKE 32, <<left>>
POKE 33, <<width>>
POKE 34, <<top>>
POKE 35, <<bottom + 1>>
```

Screen values must lie within some practical limits, but these are easy to live with. The minimum values for the left, width, and top parameters are zero, and for the bottom it's one. The maximum value for the top is 23, and for the bottom it's 24. (No matter what the value for the bottom line is, you always add one to it.) The maximum left and width values

are 39 or 79, depending on whether you're using a 40- or 80-column screen, respectively.

Screen dimensions also have some logical constraints, namely that the value for the left edge of the window can't be larger than its width, and the value of the top edge can't be greater than that of the bottom.

Making an EXEC File

Assembling all the control codes into a program doesn't involve much work. Ideally, you should set the codes and window instructions into subroutines you can CALL from the main body of the program (see **Listing 1**). I've selected line numbers that are unlikely to appear in a program. You can change them as needed for your work. If you need to re-type these lines over and over for each of your programs, however, the fun will quickly evaporate. It would be much better if you could CALL them to add them to the program on which you're working.

Of course, if you save this subroutine as a program, you can't CALL it to append it to a program that's already in memory. Saved in program format, this subroutine will erase an existing program when you load it. To prevent that, add these lines to

Listing 1:

```
1 PRINT CHR$(4);"OPEN CONTROL,D2"  
2 PRINT CHR$(4);"WRITE CONTROL"  
3 LIST 10000-  
4 PRINT CHR$(4);"CLOSE CONTROL"  
5 END
```

Instead of saving the program, run it. Lines 1 through 5 open a file called CONTROL on drive 2 (omit the ,D2 if you have a one-drive system), write the lines from 10000 to the end of the subroutine into CONTROL as lines of text, and close CONTROL when that's finished. After that, whenever you want to add that subroutine to a program, it's just a matter of using the following command to load those lines in *without* erasing anything already in memory: EXEC CONTROL,D2

You'll overwrite any program lines that duplicate those contained in the subroutine, however.

Listing 1. Basic screen-control codes.

```
10000 REM SCREEN CONTROL CODES  
10010 CSS = CHR$(12): REM CLEAR SCREEN  
10020 UPS = CHR$(23): REM SCROLL UP  
10040 DNS = CHR$(22): REM SCROLL DOWN  
10050 LFS = CHR$(10): REM LINEFEED  
10060 BS$ = CHR$(8): REM BACKSPACE  
10070 ELS = CHR$(29): REM CLEAR TO END OF LINE  
10080 ESS = CHR$(11): REM CLEAR TO END OF SCREEN  
10090 M1$ = CHR$(27): REM ENABLE MOUSE TEXT  
10100 M0$ = CHR$(24): REM DISABLE MOUSE TEXT  
10110 RETURN  
11000 REM WINDOW CONTROL  
11010 POKE 32,L  
11020 POKE 33,W  
11030 POKE 34,T  
11040 POKE 35,(B + 1)  
11050 RETURN
```

Creating Pull-Down Menus

Now that you've learned some screen-control basics, what can you do with them? You can create pull-down menus—a major reason for the Macintosh environment's ease of use. At the top of the screen, a menu bar contains choices the mouse can drag out. That's simple to duplicate for enhanced video firmware.

APPLE® //+ OWNERS...NOW YOU CAN RUN APPLEWORKS!

For all the thousands of Apple //+ owners who've been unable to run AppleWorks, Davka comes to the rescue with **ItWorks™**. **ItWorks** is simply the *best* software program available that makes your //+ AppleWorks compatible. Just slip **ItWorks** into the disk drive, and your trusty //+ will be able to smoothly run Apple's top-rated integrated software program. **ItWorks** will run with any //+ outfitted with an 80-column board and a minimum 64k memory. In fact, **ItWorks** enables AppleWorks to work with most memory boards available for the //+,—128k,256k, and more! **ItWorks** is available for only **\$39.50**. And, for a limited time, we're selling a combination package of **ItWorks** and **AppleWorks** (newest version—1.3) for just **\$229!** Here's another special value—a genuine Apple 256k memory expansion board and **Itworks** for just **\$239!** To order, call 1-800-621-8227. Major credit cards accepted. All prices plus \$2 shipping. Dealer inquiries welcome.

Davka Corporation
845 N. Michigan Ave.
Chicago, IL 60611

ITWORKS WORKS WITH FRANKLINS, TOO!

Apple is a registered trademark of Apple Computer, Inc.

Circle 144 on Reader Service Card.

Listing 2 supplies you with a menu bar for six pull-down menus (lines 9020–9065). The actual menu box for each menu title comes from lines 8000–8060. Notice that I've left the menus blank: You can fill them in with your own choices.

Before you send the program off to create a menu box, you must supply values for the variables H (the horizontal starting position of the box on the menu bar), ML (the menu-box length), and MW (the menu-box width). The value for the top of the menu box is always two, since that's where the menu bar at the top of the screen ends. You pull down menus directly from this location.



The actual menu initialization occurs in lines 500, 600, 700, 800, 900, and 1000 for the six menu choices I've included. (You can change the titles for any of the menus from within those lines.) The menu selection—either by mouse or by keyboard—occurs in the routines you create between lines 100 and 599.

The program in **Listing 2** is both a template and a free-running demonstration. It sequentially displays empty menu boxes for every option until you've seen what each looks like. Whenever the program creates a menu box, it reduces the size of the active window to the size of the box. When you use the program for your own code, remove the FOR X = 1 TO 800 timing loops that keep the display moving and replace them with individual menu options appropriate for your program.

In several lines of the demo, I've set inverse on, initialized mouse text, and printed uppercase A's or L's. Turning on inverse and enabling mouse text transforms these letters into mouse characters. The program below will display all the mouse characters:

```
10 PRINT CHR$(4);"PR#3":REM ACTIVATE ENHANCED FIRMWARE
20 INVERSE:PRINT CHR$(27):: ENABLE MOUSE TEXT
30 PRINT "@ABCDEFGHIJKLMNQRSTUWXYZ\`~";
49 PRINT CHR$(24):: NORMAL:REM DISABLE MOUSE TEXT
```

Reading the Mouse

All that remains now is an explanation of the routines that handle the mouse and the keyboard. Basic mouse control requires four simple lines of code:

```
PRINT CHR$(4);"PR#4":PRINT CHR$(1)
PRINT CHR$(4);PR#0
PRINT CHR$(4);"IN#4"
INPUT "X,Y,C"
```

I'm assuming your mouse interface card is in slot 4, the default slot number for the Apple //c. The first line opens the slot for printing and initializes the card with CHR\$(1). Line 2 brings things back to the Apple screen, and line 3 initializes the slot for reading. The fourth line reads in the actual values from the card.

X and Y are the respective horizontal and vertical positions relative to the mouse's position on the screen. Each has a range of zero to 1023, with the home or starting position being the upper left-hand corner. Since the Apple text screen is either 40 by 24 or 80 by 24, this range immediately causes a problem—but only a momentary one.

Calculating the X,Y Position

The Apple uses a 7-by-8 matrix for each character. (The characters themselves are composed of a 5-by-7-dot matrix; the additional space is used to insert blank space between characters.) Some multiplication shows that on a 40-by-24 screen, the total number of dots possible for all characters is 40 × 7, or 280, horizontal dots and 24 × 8, or 192, vertical dots. On an 80-column screen, it's 80 × 7, or 560,

horizontal dots and 24 × 8, or 192, vertical dots. (Those are the respective resolutions for the hi-res and double hi-res screens.)

Listing 2. Menu-control demonstration.

```
8 PRINT CHR$(4);"PR#3
9 GOSUB 10000
10 FOR X = 1 TO 79
20 LI$ = LI$ + "L": REM PRODUCES A STRAIGHT LINE
30 NEXT X
40 PRINT CSS;
50 GOSUB 9020
60 :
100 REM --- ROUTINES TO DETERMINE MOUSE OR KEYSTROKE
500 REM SELECT APPLE MENU
510 VTAB 1: HTAB 1: INVERSE : PRINT " ";M1$;"A";M0$;" " ;
: NORMAL : PRINT
520 ML = 12:H = 1:MW = 15: GOSUB 8000
530 T = 2:B = ML - 2:W = MW - 2:L = H: GOSUB 11000
540 PRINT CHR$(25);
550 FOR X = 1 TO 800: NEXT
590 GOSUB 9020
600 REM SELECT FILE MENU
610 VTAB 1: HTAB 10: INVERSE : PRINT "FILE " ;: NORMAL
620 H = 10: GOSUB 8000
630 T = 2:B = ML - 2:W = MW - 2:L = H: GOSUB 11000
640 PRINT CHR$(25);
650 FOR X = 1 TO 800: NEXT
690 GOSUB 9020
700 REM SELECT EDIT MENU
710 VTAB 1: HTAB 20: INVERSE : PRINT "EDIT " ;: NORMAL
720 H = 20: GOSUB 8000
730 T = 2:B = ML - 2:W = MW - 2:L = H: GOSUB 11000
740 PRINT CHR$(25);
750 FOR X = 1 TO 800: NEXT
790 GOSUB 9020
800 REM SELECT COMMAND MENU
810 VTAB 1: HTAB 30: INVERSE : PRINT "COMMAND " ;: NORMAL
820 H = 30: GOSUB 8000
830 T = 2:B = ML - 2:W = MW - 2:L = H: GOSUB 11000
840 PRINT CHR$(25);
850 FOR X = 1 TO 800: NEXT
890 GOSUB 9020
900 REM SELECT OPTIONS MENU
910 VTAB 1: HTAB 45: INVERSE : PRINT "OPTIONS " ;: NORMAL
920 H = 45: GOSUB 8000
930 T = 2:B = ML - 2:W = MW - 2:L = H: GOSUB 11000
940 PRINT CHR$(25);
950 FOR X = 1 TO 800: NEXT
990 GOSUB 9020
1000 REM SELECT SPECIAL MENU
1010 VTAB 1: HTAB 60: INVERSE : PRINT "SPECIAL " ;: NORMAL
1020 H = 60: GOSUB 8000
1030 T = 2:B = ML - 2:W = MW - 2:L = H: GOSUB 11000
1040 PRINT CHR$(25);
1050 FOR X = 1 TO 800: NEXT
1090 GOSUB 9020
1100 END
8000 REM MAKE MENU BOX
FOR X = 2 TO ML
8030 VTAB X: HTAB H: GOSUB 9000: HTAB H + MW: GOSUB 9010: PRINT
8040 NEXT X
8050 HTAB H: INVERSE : FOR X = 1 TO MW + 1: PRINT M1$;"L";M0
$: NEXT X: NORMAL
8060 RETURN
9000 INVERSE : PRINT M1$;" ";M0$:: NORMAL : RETURN
9010 INVERSE : PRINT M1$;"Z";M0$:: NORMAL : RETURN
9020 T = 0:B = 23:L = 0:W = 79: GOSUB 11000
9030 PRINT CSS
9050 VTAB 1: HTAB 2: INVERSE : PRINT M1$;"@";M0$:: NORMAL : HTAB
10: PRINT "FILE": HTAB 20: PRINT "EDIT": HTAB 30: PRINT
"COMMAND": HTAB 45: PRINT "OPTIONS": HTAB 60: PRINT "S
PECIAL": VTAB 2: HTAB 1: INVERSE : PRINT M1$;LI$;M0$:: NORMAL
9055 T = 2:W = 79:B = 23:L = 0: GOSUB 11000
9060 PRINT CSS;
9065 RETURN
10000 REM SCREEN CONTROL CODES
10010 CSS = CHR$(12): REM CLEAR SCREEN
10020 UP$ = CHR$(23): REM SCROLL UP
10040 DN$ = CHR$(22): REM SCROLL DOWN
10050 LF$ = CHR$(10): REM LINEFEED
10060 BS$ = CHR$(8): REM BACKSPACE
10070 EL$ = CHR$(29): REM CLEAR TO END OF LINE
10080 ES$ = CHR$(11): REM CLEAR TO END OF SCREEN
10090 M1$ = CHR$(27): REM ENABLE MOUSE TEXT
10100 M0$ = CHR$(24): REM DISABLE MOUSE TEXT
10110 RETURN
11000 REM WINDOW CONTROL
11010 POKE 32,L
11020 POKE 33,W
11030 POKE 34,T
11040 POKE 35,(B + 1)
11050 RETURN
```

This man has the *EasyCard*...

and this man does not.
Obviously...

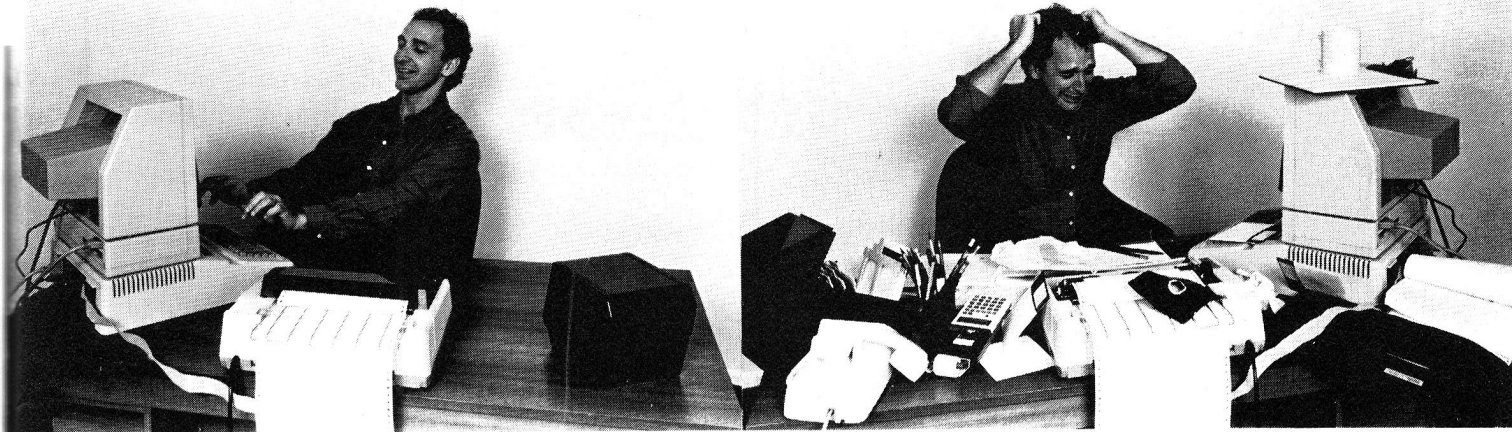

EasyCard... it makes your life easier.

Featuring 6 Systems in One

★ SideJob ★ MacroKey ★ InstaDOS ★ Screen Dumps ★ Copy Program ★ Clock

EasyCard is a peripheral card for Apple II+ and IIe that allows you to suspend execution of any application program. At that point you can run any of the *EasyCard* software systems; you can organize your desk with the **SideJob**, print the content of the screen with the **Screen Dump** or make a copy of the application program in memory with the **Copy Program**. And when you are done, return back to your application program with a single keystroke, as if nothing happened. The **MacroKey** system allows you to assign long character strings to a single key and play these back any time with a single keystroke. And that is not all; with our **InstaDOS** system you

can load DOS 3.3 or ProDOS without ever reaching for a diskette. On board **Clock** is of course DOS/ProDOS compatible.

All of the *EasyCard* software systems are resident in the card; so there are no diskettes to load. Future additions to the *EasyCard* software family will be available on simple to install EPROM's. Unlike the so called "enhancers" the *EasyCard* does not steal any Apple's memory from your application programs. **The *EasyCard* hardware and software is compatible with all 6502/65C02 application programs. Absolutely no modification is needed for your software.**

★ **SideJob** is to Apple what SideKick is to IBM PC. Modeled after the Borland's top seller of 1985 the SideJob will clean-up your desk in minutes. With a keystroke get into the SideJob window where you can run a Calculator with numerical and logical functions, jot down notes on a Note Pad, glance at the ASCII Table or do decimal-hex-binary conversions. When you are done, single keystroke gets you back to your application program as if nothing happened.

★ **MacroKey** is a perfect solution to repetitive typing of lengthy character strings. Just assign strings of characters to keys of your choice and everytime you press these again while holding *EasyCard*'s secret key the strings will be typed in automatically. To all application programs this will appear as if typed by you. Now that's artificial intelligence working for you!

★ **InstaDOS** is like having DOS 3.3 or ProDOS built directly into your Apple. Now you can store each of these utilities in the *EasyCard* memory and download them without ever using the diskettes again. What a time saver!

★ **Screen Dump** will give you a hard copy of what is on the screen. Exactly as you see it and any time you want it! Prints text, HI and DOUBLE HI RES graphics or mixed displays at a push of a button. Can even blow-up graphics to twice the size! Compatible with most popular printers and interface cards. Unlike other screen dump software or cards this system works also on protected programs.

★ **Copy Program** is an extensive utility software package. It allows you to make backup copies of all (including protected!) memory resident programs of up to 128k at a push of a button. Copying time is less than 30 seconds. The copy produced is unprotected and subject to study or change. Special software included allows the copy to run without the *EasyCard* in the Apple. Other functions can be used to single step and trace through any program.

★ **Clock** is of course ProDOS compatible. But now you can also check the time/date while in the middle of any application program. That is something no other clock can do!

Pricing Information: *EasyCard* board without any software: \$119.99; for each software system add \$29.99. Buy packaged sets and save: Starter Set with the board, the Copy Program, Screen Dumps and SideJob: \$159.96 (save \$50); Advanced Set with all six systems: \$219.93 (save \$80). Add \$5.00 for shipping and handling. Calif. residents please add 6% (L.A. County 6.5%) Calif. Sales Tax. Please specify computer, printer and interface card when ordering.

ATL's *EasyCard* . . .



don't use your Apple without it!

APPLIED TECHNOLOGY LABORATORIES 11926 Santa Monica Boulevard, Los Angeles, California 90025 (213) 477-6815

Trademarks: Apple II+ and Apple IIe are trademarks of Apple Computer, Inc. IBM PC is a trademark of International Business Machines Corp. SideKick is a trademark of Borland International, Inc.
Circle 243 on Reader Service Card.

**It Talks!
It Recognizes!
It Writes Music!**
and more . . .

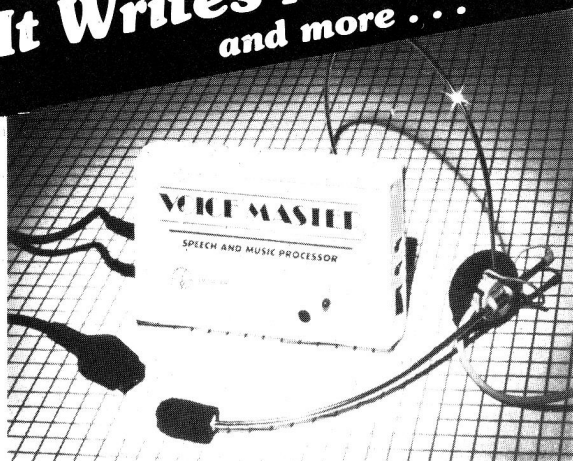

THE AMAZING VOICE MASTER® Speech and Music Processor

Your computer can talk in your own voice. Not a synthesizer but a true digitizer that records your natural voice quality—and in any language or accent. Words and phrases can be expanded without limit from disk.

And it will understand what you say. A real word recognizer for groups of 32 words or phrases with unlimited expansion from disk memory. **Now you can have a two way conversation with your computer!**

Easy for the beginning programmer with new BASIC commands. Machine language programs and memory locations for the more experienced software author.

Exciting Music Bonus lets you hum or whistle to write and perform. Notes literally scroll by **as you hum!** Your composition can be edited, saved, and printed out. You don't have to know one note from another in order to write and compose!

Based upon new technologies invented by COVOX. One low price buys you the **complete system**—even a voice controlled black-jack game! In addition, you will receive a subscription to COVOX NEWS, a periodic newsletter about speech technology, applications, new products, up-dates, and user contributions. **You will never find a better value for your computer.**

ONLY \$89.95 includes all hardware and software.

For telephone demonstration or additional information, call (503) 342-1271. FREE audio demo tape and brochure available.

Available from your dealer or by mail. When ordering by mail add \$4.00 shipping and handling (\$10.00 for foreign, \$6.00 Canada).

The Voice Master is available for the C64, C128, all Apple II's, and Atari 800, 800XL and 130XE. Specify model when ordering.



For Faster Service on Credit Card Orders only:

ORDER TOLL FREE 1-800-523-9230



COVOX INC. (503) 342-1271
675-D Conger Street, Eugene, OR 97402
Telex 706017 (AV ALARM UD)



Resorting to mathematics again, on a 40-column screen, the horizontal position of the mouse in terms of each text character is the integer that results when you multiply the X value you input by 280/1024, then divide that result by 7, and finally add one to your answer:

$$\text{INT}((X*(280/1024))/7) + 1$$

On an 80-column screen, that formula is:

$$\text{INT}((X*(560/1024))/7) + 1$$

For both screen sizes, the vertical character position is:

$$\text{INT}((Y*(192/1024))/8) + 1$$

Without the one added at the end, the readings would be in the range of zero to 39 or zero to 79 and zero to 23. If that's logical to you, you can leave off the one to make the formula shorter.

Pushing the Button

The C parameter used in the INPUT statement reads the condition of the mouse's button. It can appear with any value between one and four, indicating the condition of the button during the current reading and during the last reading. A value of one shows that you haven't pressed the button during the last two readings. A two results if you pressed the button the last time the C parameter read the button's status, but not this time. A three indicates the reverse: You didn't press the button before, but you are now. A value of four indicates that you pressed the button during the last two readings.

Reading the Keyboard

Not to leave the keyboard out, you can monitor key pressing two ways. If you PEEK at memory location -16368, you'll find that the value there is zero if no key is pressed. As soon as you press a key, the Apple places a nonzero value in that location.

Also, the value of the mouse's C parameter becomes negative—a dead giveaway even if you're not looking at location -16368. If you find that either of these conditions has been met, you can make your program branch to a character-input routine to read the value of the key pressed.

Reset the C value to positive by using POKE to place a zero in location -16368 (which resets the key-down status at the same time).

Rounding It All Up

If you apply what you've read and try the examples I've supplied, you can master the Apple's screen without resorting to machine language. With a little care, you can substitute these Applesoft routines in your own programs in place of existing menu routines—and have Mac-like pull-down menus whether or not you really have a mouse. ■

Bill O'Brien is author of The Apple IIc Book (among others) and can be reached at P.O. Box 1010A, Fort Lee, NJ 07024, or via CompuServe account 74216,1215.

Why Are Apple Owners So Loyal?

People who have the best often are, but in the case of Apple there's more. Apple owners think back to how Apple got started in 1977, just two people working out of a garage and what happened is the talk of Wall Street and the computer industry as well. Many like the fact that Apple only makes computers. Unlike their competition they don't make typewriters, copiers or telephones. They do just one thing and that's one reason they do it so well.

At Applied Engineering we think the same way. You see, Applied Engineering is the only major hardware manufacturer totally dedicated to the Apple computer. Whereas most of our competitors must divide their customer support and engineering time between IBM, Atari, Radio Shack or other computers, our engineers only design products for the Apple. This dedication allows us to be much more familiar with the Apple and the people who use them.

We don't expect you to buy an Applied Engineering peripheral on loyalty alone, but when you compare our products to those made by QUADRAM, MICROSOFT, AST and others you'll find out why Applied Engineering means a quality design, innovation, craftsmanship and total Apple compatibility.

The other guys do pretty well considering how busy they are with IBM. But at Applied Engineering, ALL of our work involves the Apple. In fact, all of our employees were Apple owners before they came to work for us. The people in shipping, engineering, quality control, order entry, all use Apples at work and at home.

This one track mindedness of ours allows us to offer the largest storage with AppleWorks and most other programs and our Z-80 card includes the new 4.0 operating system. We can expand the Apple IIe to over 5 MEGABYTES of memory and we've got clock cards, accelerator cards, music

cards, A to D converters, digital controllers, and a BSR system so your Apple can control your whole house with no additional wiring!

Applied Engineering recognizes that we've got to do a better job than our IBM counterparts because we know you're smarter than the average computer buyer, you bought an Apple. You see, our competition has it a little easier, their customers aren't as smart as you. After all, they bought the wrong computer.

So if you need more memory, or want your Apple to run faster, or have 80 columns, or RGB color, double hi res graphics, if you want to know the time and temperature or other "real world" conditions, if you'd like to run CP/M software, have a RAM disk, increase the storage of AppleWorks and other programs, if you want your Apple to play music, talk and sing, if you'd like your Apple to control the lights and appliances in your house, then do what NASA does, what Ford does, what the U.S. Government, Hughes Aircraft, Honeywell, Westinghouse, AT&T, Apple Computer, and even what Steve Wozniak does, call Applied Engineering. Then you will discover what thousands of companies and over a hundred thousand Apple owners already know, that you can be smart and loyal all at the same time.

We Set the Standard



APPLIED ENGINEERING

(214) 241-6060

For information and specifications on Applied Engineering's line of Apple peripherals, please see our ads in this magazine. Prices are given.

It's amazing what you can reveal when you strip.

Introducing a shape that's about to turn on an entire industry.

The Softstrip™ data strip. From Cauzin.

This new technology allows text, graphics, and data to be encoded on a strip of paper, then easily entered into

your computer using a scanning device called the Cauzin Softstrip™ System Reader.

Creating a simple, reliable and cost efficient way to distribute and retrieve information.

Softstrip data strips, like those you see here, can contain anything that can be put on magnetic disks.

Facts. Figures. Software programs.

Video games. Product demonstrations.

Sheet music.



The Cauzin Softstrip System Reader is now compatible with the IBM PC, Apple II and Macintosh.

A single strip can hold up to 5500 bytes of encoded data.

It can stand up to wrinkles, scratches, ink marks, even coffee stains.

And it can be entered into your computer with a higher degree of reliability than most magnetic media.

Simply by plugging the Cauzin Reader into your serial or cassette port and placing it over the strip.

The reader scans the strip, converts it to computer code, and feeds it into any standard communication interface.

Because strips are so easy to generate, most of your favorite magazines and books will soon be using them in addition to long lists of program code.

And you'll be able to enter programs without typing a single line.

There is also software for you to generate your own strips.

Letting you send every-

thing from correspondence to business information using our new technology.

Find out how much you can reveal by stripping. Just take this ad to your computer dealer for a demonstration of the Cauzin Softstrip System Reader.

Or for more information and the name of the dealer nearest you, call Cauzin at 1-800-533-7323. In Connecticut, call 573-0150.

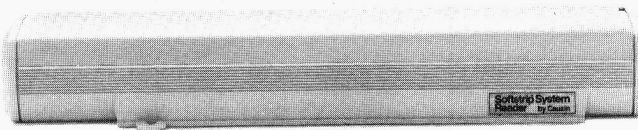

The Cauzin Softstrip System Reader replaces tedious typing by scanning the strip and reading it into your computer.

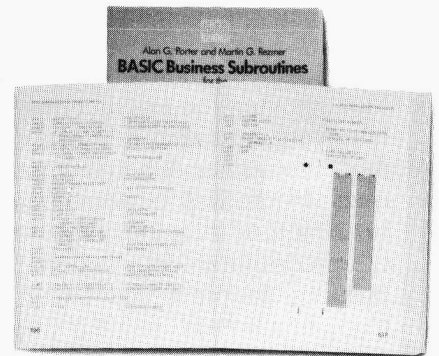

Soon everyone will be stripping as data strips appear in popular magazines, computer books and text books.



Cauzin Systems, Inc.
835 South Main St., Waterbury, CT 06706

IS IT DOG, OR IS IT CHIEN?

The data strips on the right contains the program FLASHCARDS by Peter and Jerry Lachenbruch, which appeared in the May, 1984 issue of inCider. You'll find the program useful whether you're trying to learn French or brush up on some basics.

There is a collection of 30 word pairs, for studying conjugations of selected verbs. The program also contains a list of 20 word pairs for the advanced French linguist.

Read the two strips (near right) into your computer and RUN the program. You can also run it from the Cauzin communications disk. Exit any time by pressing CONTROL-RESET.

SOLVING GRAPH EQUATIONS

FUNCTION PLOTTER, a program by Don Fudge, appeared in the April, 1984 issue of inCider. A function plotter is a utility that solves and graphs equations (functions) that represent mathematical relationships between variables.

The equation might be something simple like $Y = X - 3$. It can be more complex like $Y = \sin(X)$ or $Y = 3(\sin(1/3(X - \pi/3)))$. A bell curve in statistics, a parabolic curve in physics and astronomy, a cosine curve in trigonometry, or a square wave curve in psychology are all examples of graphed functions.

Read the two strips (far right) into your computer and RUN the program. You can also run it from the Cauzin communications disk. Exit any time by pressing CONTROL-RESET.

Reprinted with permission by inCider magazine, a CW Communications, Inc. publication.
1984 © CW Communications/Peterborough, Inc.

StripWare Library Nos. 180-181

1 |

2 |

1 |

Softstrip 2 |

Softstrip

APPLEWORKS IN ACTION

Preparing a Price Quote with an AppleWorks Spreadsheet

by Ruth K. Witkin

Like any other consumers of goods and services, businesses shop around for the best prices. If your business sells something to other businesses, you're likely to get your fair share of RFQs (requests for quotation). AppleWorks makes it easy to prepare clear, consistent, and competitive quotes that can help your business become more successful.

In this session, the second of three parts, you'll create a spreadsheet with a lookup table of hardware supplies and wholesale prices for your company, Rocky Hill Hardware Supply. When you enter an item number, the formulas find the unit price in the lookup table, enter it in the quote, calculate the extension (unit price times quantity), and produce the subtotal, discount, and total quote. **Figure 1** shows the completed spreadsheet.

You won't need the mailing list you created last month to do the quote spreadsheet, but you will have to create this spreadsheet to do next month's example, which integrates the quote section with a letter.

How a Lookup Table Works

A lookup table consists of two rows or two columns of cells you indicate on a spreadsheet. One row or column contains scan numbers and the other contains corresponding numbers. A formula with the LOOKUP function searches the scan cells for a number you designate and retrieves the corresponding number, saving you the time of looking it up and typing it in.

If the scan cells are in a row, the formula searches the table from left to right until it finds the largest number less than or equal to your number, and retrieves the number from the cell immediately below. If the scan cells are in a column, the formula searches the table from top to bottom

AppleWorks helps you prepare professional-looking request-for-quotation spreadsheets.

and retrieves the number from the cell to the immediate right.

Keystrokes and Other Matters

When you see such key combinations as OA-L, hold down the open apple key and type L. With repeated combinations, such as OA-left arrow (4 times), hold down the open apple key and press the left arrow key four times. If you make a typo, the delete key backs up the cursor and erases the character before it.

At several stages of the creation process, you'll have to save the spreadsheet. If you have a one-drive system, watch the screen for prompts

that tell you when to swap the program disk for the data disk.

Creating the Spreadsheet from Scratch

Use the AppleWorks Startup and Program disks to bring up a new spreadsheet screen. Name this file **QUOTE**. You should now see the Review/Add/Change screen. Assuming you're familiar with AppleWorks, use the following summary to set up the spreadsheet so it looks like the one in **Figure 2**.

Dashed Lines—Each column is now nine characters wide. Use an equal sign to enter the line in A2 through F2 and in A16 through D16. Use a minus sign to enter the line in A5 through F5, A10 through F10, and A18 through D18. In each case, type quotation marks before typing the sign.

Column Widths—Use the Layout command (OA-L) to reduce the width of column A by four characters, reduce

Figure 1. AppleWorks spreadsheet used for price quotations to customers.

| Quote to Bob Nissen, Nissen Brothers | RFQ 23451 | | | |
|--------------------------------------|-----------|---------------------------|------------|----------------|
| Qty | Item # | Description | Unit Price | Extended Price |
| 48 | 259 | Phillips Screwdrivers | \$2.50 | \$120.00 |
| 24 | 250 | Crescent Wrenches | \$6.75 | \$162.00 |
| 24 | 210 | Harris Drill Sets | \$32.55 | \$781.20 |
| 12 | 283 | Cartons 20d Common Nails | \$65.00 | \$780.00 |
| Subtotal | | | | \$1,843.20 |
| Discount | | | | \$92.16 |
| Total | | | | \$1,751.04 |
| PRICE LOOKUP TABLE | | | | |
| Item | Price | Description | | |
| 210 | 32.55 | Harris Drill Set | | |
| 250 | 6.75 | Crescent Wrench | | |
| 259 | 2.50 | Phillips Screwdriver | | |
| 276 | 15.75 | Wood Chisel Set | | |
| 283 | 65.00 | Carton 20d Common Nails | | |
| 287 | 72.50 | Handing Belt Sander | | |
| 291 | 125.00 | Romex 3x#12 Cable (1000') | | |
| 292 | NA | | | |

3.7 Meg 16-Bit IIe

Why pay more for a lesser card just because it's advertised a lot? You can buy Checkmate Technology's **State-Of-The-Art MULTIRAM IIe™** that works great in 8-Bit (100%), has an optional real 16-Bit 65C816 slot saver Co-Processor card, **PORT FOR OPTIONAL BATTERY BACKED-UP MEMORY, FREE RGB, &** in coming months semi-permanent **STATIC RAM options** that can load & save entire programs, like AppleWorks, up to 10 years!

- **MULTIRAM IIe IS A DIRECT SUBSTITUTE FOR RAMWORKS II™ or Apple Ext 80 column cards & fits ALL (even Euro) Apples. It RUNS ALL (100%) 3rd PARTY SOFTWARE** that the others do.
- **TWO MAIN BOARDS TO PICK FROM** both with 16-Bit port, sharp 80 columns & Double Hi-Res Graphics. One with **FREE RGB & STATIC RAM PORT**-expandable to 1024k standard RAM + 2048k BATTERY BACKED-UP STATIC RAM, and one without RGB or port-expandable to 768k. Both cards can piggyback for a **TOTAL POSSIBLE MEMORY OF 3.75 MEGABYTES IN ONE SLOT. AND UNLIKE RAMWORKS II**, there is never a chance to touch cards in slot one (such as Super Serial Card).
- **OPTIONAL 16-Bit 65C816 CO-PROCESSOR CARD** that plugs into MULTIRAM using no slots! **TRULY STATE-OF-THE-ART, BUT IT CAN'T RUN ON RAMWORKS™!**
- **FREE APPLEWORKS TIME/DAY/DATE ON-SCREEN SOFTWARE. FREE AUTO-COPY SOFTWARE (disk to RAM). FREE ULTRA-FAST RAM DISK SOFTWARE** that can be run alone or WITH APPLEWORKS. **FREE RAM TEST & optional CP/M & Pascal Ram disk (\$20. ea)!**
- **FREE APPLEWORKS EXPANDER SOFTWARE** that modifies AppleWorks once-loads ALL (even printer routines) or PARTS of AppleWorks into memory, runs 30 x faster, increases the Desktop over 1125k, auto-segments large files onto multiple disks, stores over 5325 records! An increased Clipboard & Word Processor update is due soon.
- **15 DAY MONEY BACK SATISFACTION GUARANTEE, FREE SOFTWARE UPDATES, FREE 64k MEMORY WITH EACH 256k/512k CARD, & QUANTITY DISCOUNTS FROM**

COIT VALLEY COMPUTERS. EXCLUSIVE 5 YEAR WARRANTY THAT, UNLIKE RAMWORKS, INSURES COVERAGE NO MATTER WHERE YOU BOUGHT IT! **CALL FOR CURRENT PRICES, QUANTITY DISCOUNTS, NEW FEATURES OR DETAILS ON CHECKMATE'S DIRECT \$50 REBATE FOR OLDER CARDS!**

| | | LOWER | |
|---------------------------------------|-----------------------------|----------------------|---------------|
| | | OUR LOW PRICE | No RGB |
| 64k | MULTIRAM IIe/FREE RGB | 185. | 147. |
| 128k | MULTIRAM IIe/FREE RGB | 203. | 168. |
| 320k | MULTIRAM IIe/FREE RGB | 222. | 189. |
| 576k | MULTIRAM IIe/FREE RGB | 272. | 237. |
| 768k | MULTIRAM IIe/FREE RGB | 322. | 287. |
| 1024k | MULTIRAM IIe/FREE RGB | 372. | N/A |
| 1280k | MULTIRAM IIe/FREE RGB | 520. | N/A |
| 1536k | MULTIRAM IIe/FREE RGB | 548. | N/A |
| 1792k | MULTIRAM IIe/FREE RGB | 578. | N/A |
| 256k Memory Expander Chips (8) | | 55. | |
| Apple IIe Enhancement Kit | | 62. | |
| Clockworks | | | |
| (Thunder/Time H.O.™ compatible) | | 89. | |
| FD 100 Slimline Drive IIe, II+ | | 107. | |
| 65C816 Co-Processor Card | | 162. | |
| Pinpoint Software | | 49. | |
| Disk Mailers (10) | | 7. | |
| Accelerator IIe-speedup card | | 249. | |

CALL FOR OTHER APPLE PERIPHERAL PRICES.

640k 16-Bit IIc!

Checkmate Technology's **State-Of-The-Art IIc cards** easily expand your IIc up to 640k, are 100% compatible with all IIc software/hardware, & come with the **SAME FREE SOFTWARE** as MULTIRAM IIe. **MULTIRAM C** is non-upgradable & **MULTIRAM CX** can be upgraded with a **16-Bit 65C816 kit!** **CALL FOR CURRENT PRICING & QUANTITY DISCOUNTS!**

- **NO JUMPER WIRES, CLIPS, OR DRIVE REMOVAL REQUIRED FOR INSTALLATION. ALL CHIPS ARE SOCKETED AND REMOVABLE**-unlike the competition.
- **USES ABOUT 50% LESS POWER** than the competition-causing less power supply strain or battery pack drain!
- **15 DAY MONEY BACK SATISFACTION GUARANTEE** from Coit Valley Computers. **5 YEAR WARRANTY THAT, UNLIKE THE COMPETITION, INSURES COVERAGE NO MATTER WHERE YOU BOUGHT IT!**
- **LOWER PRICES**-We sell IIc cards for much less than the competitor and our software updates are free, while they usually charge \$10 or more!

| | | LOWER | |
|--|-------------------|----------------------|--|
| | | OUR LOW PRICE | |
| 256k | MULTIRAM C | 224. | |
| 512k | MULTIRAM C | 264. | |
| 256k | MULTIRAM CX | 278. | |
| 512k | MULTIRAM CX | 318. | |
| 16-Bit 65C816 CX Kit (\$10 less with card) | | 135. | |
| IIc System Clock (Same as A.E.) | | 66. | |
| IIc Battery Pack & U.P.S. | | 174. | |
| C-VUE Flat Panel Display (\$10 less with card) | | 439. | |

Terms: Add \$4-Ground or \$6-Air shipping & phone # to each U.S. order (foreign orders extra). Add 3% for P.O.'s (3% 7 net 30) & MasterCard/Visa (include #/expir). For fast delivery send Cashier's/Certified check, Money Order. C.O.D. (add \$5) & personal checks accepted (allow 14 days). Tex res add 6 1/8% tax. **CALL FOR CURRENT PRICES & QUANTITY DISCOUNTS!**

MULTIRAM, Ramworks/Ramworks II/TimeMaster II H.O., Pico respective trademarks of Checkmate Technology, Applied Engineering, WGE.

COIT VALLEY COMPUTERS (214) 234-5047
14055 Waterfall Way Dallas, Texas 75240

MANAGE YOUR BUSINESS, NOT YOUR BOOKS!

INTRODUCING BusinessWorks™



Courtesy of Apple Computer, Inc.

Apple is a registered trademark of Apple Computer, Inc.
AppleWorks is a trademark of Apple Computer, Inc.

You've put time and energy into building your business. Now take the next step. Meet BusinessWorks, the ultimate business accounting package for people who demand high performance.

BusinessWorks offers you complete financial control over your company. Comprehensive reporting capabilities, including summary "flash" reports, help you make vital management decisions. And, BusinessWorks

allows you to analyze your financial information in AppleWorks, the best-selling integrated software package.

Designed specifically for Apple's new high-powered computers, BusinessWorks includes five full-featured accounting applications. With help messages at almost every point, and "show" windows that display needed codes or IDs, it's incredibly easy to use.

See it for yourself! Visit your dealer today for a demonstration, and get down to business — with BusinessWorks.



Developers of The Business Accountant™
and The Advanced Business Accountant™

(916) 781-3880



BusinessWorks, Manzanita Software Systems and the Manzanita logo are trademarks of Manzanita Software Systems, Inc.
© 1985 Manzanita Software Systems, Roseville, CA 95678.

Circle 241 on Reader Service Card.

APPLEWORKS IN ACTION

column C by six characters, increase column D by 17 characters, and increase column F by three characters.

Labels and Lookup Table—Enter the labels in rows 3, 4, and 17, in E11, E12, and E13, and in rows 15 through 26 (columns A, B, and D). Cell B26, which is empty now, will soon contain the NA function to “cap” the table.

The following formats make the labels and numbers look like those in **Figure 3**. For labels, use the Layout command (OA-L) to right-justify A4, B4, and F1, then center E3 through F4 and B17.

I often use the Commas format for numbers, even if the numbers will never be large enough to need commas. This format places the number one character shy of the right edge of the cell, producing a better alignment with headings. Use the Value command (OA-V) to set a standard value of Commas with zero decimal places. Use the Layout command (OA-L) to put the prices in the lookup table (B19 through B25) into a Commas format with two decimal places, and the unit and extended prices (E6 through F9 and F11 through F13) into a Dollars format with two decimal places. Now press OA-S to store the spreadsheet on disk.

Entering the Formulas

Figure 3 shows the locations of the formulas that perform the calculations. First, read how the formula works. Then place the cursor on the cell location. Move the cursor to the cell locations that belong in the formula and type everything else. When the formula is complete, press the return key. If you run into a snag, simply press the escape key and start again.

Formula 1: Unit Price

Formula 1, which contains the LOOKUP function, looks at the item number in B6, scans the item numbers in the price lookup table (A19 to A26), retrieves the price from the corresponding cell (B19 to B25), and enters this amount into E6. Type only one period when your cursor is on A19; AppleWorks automatically converts it to three periods.

Cell location: E6

Description:

@LOOKUP(B6,A19...A26)

Formula 1 has no item number with which to work, so NA appears.

Formula 2: Extended Price

Formula 2 multiplies the quantity (A6) by the unit price (E6) and enters the extended price into F6.

Cell location: F6

Description: +A6*E6

Formula 2 refers to E6, which contains NA, so it too displays NA.

Formulas 1 and 2 can calculate the unit price and extended price for other items. Place your cursor on E6.

Now follow these steps to start the Copy command, confirm *Within worksheet*, highlight the cells to copy from (E6 and F6), and tell AppleWorks the cells to copy into (E7 to E9). Type OA-C, press Return, press right arrow, press Return again, then press the down arrow key. Type a period, press down arrow (2 times), and press Return.

AppleWorks now highlights B6 and asks if it is a *No change* or *Relative* cell reference. To select *No change*, press Return. To select *Relative*, type

APPLE // OWNERS YOU'VE WAITED LONG ENOUGH

... for a half-height Apple® compatible disk drive that fits any Apple // you own: //+, //e, and //c.



- Faster, more precise tracking and larger capacity than standard Apple® drives.
- 100% Apple® compatible for //+, //e, and //c external drives.
- Quieter and smoother running.

- Half-height, compact design... saves you space.
- //c adaptor plug included free!
- Works with Apple's new Unidrive
- One year warranty, 30 day money back guarantee.
- Suggested retail price: \$269.95

//c AND UNIDRIVE POWER

New! Apple //c Disk Drive Adaptor Plug. Also Works With Apple's New Unidrive.

- Turns your Apple //+ or //e compatible disk drive into an Apple //c drive.
- Allows you to use your Apple compatible disk drive with Apple's new Unidrive
- Attaches in seconds—absolutely no soldering!
- 5-year warranty, 30-day money-back guarantee.

**FAST • SIMPLE • INEXPENSIVE
ONLY \$19.95**

**PICO
products**

Quality peripherals for IBM®, Apple®, and other leading microcomputers. Watch for more PICO Products at your local computer store—exceptional value and quality in computer accessories.

For Dealer and Distributor information please call or write:



WGE International Ltd.
WGE Center, Rte. 202N
Peterborough, NH 03458
1 (800) 227-1560
1 (603) 924-9261 in NH

IBM is a registered trademark of International Business Machines, Inc. Apple is a registered trademark of Apple Computer.

APPLEWORKS IN ACTION

Figure 2. Labels, lines, and lookup table in an AppleWorks quotation spreadsheet.

Figure 3. Formula locations in an AppleWorks quotation spreadsheet.

| 4 | Qty | Item # | Description | Unit Price | Extended Price |
|----|--------------------|--------|---------------------------|------------|----------------|
| 5 | | | | | |
| 6 | | | | | |
| 7 | | | | | |
| 8 | | | | | |
| 9 | | | | | |
| 10 | | | | | |
| 11 | | | | Subtotal | |
| 12 | | | | Discount | |
| 13 | | | | Total | |
| 14 | | | | | |
| 15 | PRICE LOOKUP TABLE | | | | |
| 16 | | | | | |
| 17 | Item | Price | Description | | |
| 18 | | | | | |
| 19 | 210 | 32.55 | Harris Drill Set | | |
| 20 | 250 | 6.75 | Crescent Wrench | | |
| 21 | 259 | 2.5 | Phillips Screwdriver | | |
| 22 | 276 | 15.75 | Wood Chisel Set | | |
| 23 | 283 | 65 | Carton 20d Common Nails | | |
| 24 | 287 | 72.5 | Harding Belt Sander | | |
| 25 | 291 | 125 | Romex 3x#12 Cable (1000') | | |
| 26 | 292 | | | | |

| 4 | Qty | Item # | Description | Unit Price | Extended Price |
|----|--------------------|--------|---------------------------|------------|----------------|
| 5 | | | | | |
| 6 | | | | NA (1) | NA (2) |
| 7 | | | | NA | NA |
| 8 | | | | NA | NA |
| 9 | | | | NA | NA |
| 10 | | | | | |
| 11 | | | | Subtotal | NA (3) |
| 12 | | | | Discount | NA (4) |
| 13 | | | | Total | NA (5) |
| 14 | | | | | |
| 15 | PRICE LOOKUP TABLE | | | | |
| 16 | | | | | |
| 17 | Item | Price | Description | | |
| 18 | | | | | |
| 19 | 210 | 32.55 | Harris Drill Set | | |
| 20 | 250 | 6.75 | Crescent Wrench | | |
| 21 | 259 | 2.50 | Phillips Screwdriver | | |
| 22 | 276 | 15.75 | Wood Chisel Set | | |
| 23 | 283 | 65.00 | Carton 20d Common Nails | | |
| 24 | 287 | 72.50 | Harding Belt Sander | | |
| 25 | 291 | 125.00 | Romex 3x#12 Cable (1000') | | |
| 26 | 292 | | | NA (6) | |

MacroWorks™ makes AppleWorks™ work the way it should have in the first place.

New word processing power
MacroWorks streamlines AppleWorks word processing with a multitude of new features. For example, one quick keystroke now deletes the *character* or the *word* at the cursor.

Return to our *new* office: *Macros let you type almost anything with just one keystroke.*

Harvey R. Smith
6502 Disk Drive
Uptown, CA 92103

Use one keystroke* to jump to the start or end of a line of text. Another keystroke will erase an entire line. Change your mind? Apple-U will instantly "Undo" your last delete command!

AppleWorks Macros

MacroWorks will convert any series of keystrokes into a new one-keystroke AppleWorks command. Use MacroWorks' built-in macros, or define your own. For example, make Apple-N type your name and address. Or let Apple-X Save or Print all of your desktop files, nonstop.

For AppleWorks' Word Processor, Data Base and Spreadsheet

The possibilities are endless. For example, you may want to skip unwanted questions like "How many copies?" and "Are you sure...?". Or search and replace printer commands (change all underlined words to bold, etc.).

* These are Solid-Apple commands. All original commands stay intact.

Boot AppleWorks and go
MacroWorks is *not* a time-consuming "pre-boot" disk. You boot AppleWorks like you always do, but now you've got MacroWorks' new features!

Customized Help!

MacroWorks lets you replace AppleWorks' Help screens with new information, like a list of new commands or important names and addresses.



3990 Old Town Avenue, San Diego, California 92110
MacroWorks requires AppleWorks and an Apple IIc or 128K IIe.
AVAILABLE AT MOST SOFTWARE STORES or by mail:
Visa, MasterCard or COD orders, phone toll free
1-800-227-3800 ext. 1607

Multi-Column Printouts!

MacroWorks' *Galley* program prints your AppleWorks word processing files in side-by-side columns (two or three-wide) for faster and easier newsletter layouts.

Analyze your files

MacroWorks' *File Analyzer* program prints a sorted list of every word it finds, and reports the number of occurrences of each word, and the average word length. Great for making an index or glossary, or for analyzing your writing style.

| | |
|---------------|--------------------|
| • COUNT WORD | • 1 WORK |
| • 10 A | • 1 WRITING |
| • 1 ADDRESS | • 9 YOU |
| • 1 ADDRESSES | • 1 YOU'VE |
| • 6 ALL | • 8 YOUR |
| • 1 ALMOST | • TOTAL WORDS: 402 |
| • 1 ALWAYS | • CHARACTERS: 2013 |
| | • CHARS/WORD: 5.0 |

Alphabetize your catalogs

MacroWorks' *Alpha-Cat* program prints a sorted list of all the files (or just the AppleWorks files) on a disk. Perfect for disk I. D. labels!

\$34⁹⁵ Friendly and unprotected

MacroWorks is easy-to-use, unprotected and compatible with all Apple IIc's and 128K IIe's. Like all Beagle Bros disks, you can make backups without hassle or special software.

Apple, AppleWorks and ProDOS are trademarks of Apple Computer, Inc.

Some More Facts About RAM Cards!

You could put a FLIPSTER or Apple™ 1 meg memory expansion card in slot 4 and add another FLIPSTER or Apple 1 meg memory expansion card in slot 5 (The FLIPSTER and Apple's card only expand to 1 meg). You'll need a separate 80 column card for the auxiliary slot. Oh, and put a printer buffer card in slot 2. If you want RGB color, you'll need an RGB board in slot 7 then buy a hard disk (if you have any slots left).

You'll have a bigger AppleWorks desktop, but you'll still be limited to a maximum of 1350 records in the data base. And you're stuck at 2250 lines in the word processor. And AppleWorks won't automatically load itself into memory, and make sure you don't create a file bigger than your disks can hold because neither FLIPSTER nor Apple's memory card will segment a file onto multiple disks.

Or You could get RamWorks II!®

You'll have a bigger desktop.

You'll also have up to 15,300 records (not 1350) in the data base and up to 15,300 lines in the word processor (not 2250). AppleWorks will now automatically load into RAM. And if you create a file greater than your disk capacity, no problem. RamWorks II will automatically save it on multiple disks. And because of our built-in printer buffer, you can continue to use AppleWorks while your printer is printing. Nice. RamWorks II has an RGB option, 16 bit option and is expandable to 5 megabytes. And don't forget, RamWorks II is the software industry standard for memory expansion in the IIe. RamWorks II is automatically recognized by virtually all memory intensive programs (and many more are on the way) and is 100% compatible with all IIe software. Clearly the new RamWorks II has more features, more capabilities, and most importantly, is recognized by more commercially prepared programs than any RAM card. RamWorks II is fully compatible with DOS 3.3, ProDos, Pascal 1.1, 1.2, 1.3 and all CP/M versions 2.2 through 4.0. No other memory card enhances software better. And RamWorks II is the acknowledged standard with all serious AppleWorks users.

There's only one card like RamWorks II. If someone tempts you with an imitation, please call us to get both sides of the story. You'll discover why RamWorks II offers the best enhancements to AppleWorks and a long list of other programs.

214-241-6060
9 AM - 11 PM
7 Days a Week

AE
"We Set the Standard"
APPLIED ENGINEERING

| | RamWorks II® | FLIPSTER/Apple's Card |
|--|--------------|-----------------------|
| Maximum Desktop | 2277K | 1012K |
| Maximum Number of Records in Database | 15,300 | 1350 |
| Maximum Number of Lines in Word Processor | 15,300 | 2250 |
| Autoloads AppleWorks | YES | NO |
| Auto Segments Files | YES | NO |
| Built-in Printer Buffer | YES | NO |
| Compatible With All Versions of AppleWorks | YES | NO |
| Displays Time & Date on AppleWorks Screen with Clock | YES | NO |
| Saves Slots | YES | NO |
| RGB Option | YES | NO |
| 16 Bit Co-Processor Port | YES | NO |
| Memory Expansion Ports | YES | NO |
| Patent Pending Power-Saving Circuit | YES | NO |
| 80 Columns Built-in | YES | NO |
| Maximum Memory per Slot | 5120 K | 1024 K |
| Compatible with Franklin 2000 Software | YES | NO |
| Compatible with Auxiliary Slot | YES | NO |
| Software Standard | YES | YES |
| Manufactured in | USA | England/ Singapore |
| Warranty | 5 Yrs. | 1 Yr./ 90 Days |
| Price | LESS | MORE |

AppleWorks and Apple are trademarks of Apple Computer.

APPLEWORKS IN ACTION

R. Identify which is which by typing **R**, pressing Return (2 times), and typing **R** (2 times).

Formula 3: Subtotal

Formula 3 adds the entries in F6 to F9 to produce the subtotal in F11. The formula includes the lines in F5 and F10. In this way, when you later insert rows into the quote area, AppleWorks will adjust the formula to add the new entries. Type only one

period when your cursor is on F10.

Cell location: F11

Description: @SUM(F10..F5)

Formula 4: Discount

Formula 4 uses the IF function to return one of two possible answers. Rocky Hill Hardware gives a 5 percent discount on purchases of \$1500 or more, no discount on anything less. The Test statement looks at the number in F11. If the number is

greater than or equal to 1500, the Then statement calculates 5 percent of the amount and enters the result into F12. If the number is less than 1500, the Else statement enters a zero.

Cell location: F12

Description:

@IF(F11 >= 1500, F11*.05, 0)

Formula 5: Total

Formula 5 subtracts the discount (F12) from the subtotal (F11) and enters the total into F13.

Cell location: F13

Description: +F11 - F12

Formula 6: Lookup Table "Cap"

Formula 6 prevents misleading results if you happen to type an item number larger than 291. Formula 1 (the lookup formula) will signal that something is amiss by entering NA (not available) into its cell instead of \$125.00, the largest corresponding number. Since AppleWorks can't retrieve text, having NA or any other text in a corresponding cell will only produce an ERROR message.

Cell location: B26

Description: @NA

This completes formula entry. Leave your cursor on B26 and press OA-S to store all the formulas on disk.

Entering Practice Numbers and Text

The practice entries are shown in **Figure 4**. Press OA-1 to jump the cursor to row 1. Enter the text in A1 and the RFQ number in F1. Then enter the quantities, items, and descriptions in rows 6 through 9. Your spreadsheet should now look like the one in **Figure 1**.

It's always a good idea to protect formulas from accidental change. Let's start with the unit and extended price formulas in columns E and F. Place your cursor on E6 and press OA-L. Now type **B**, press down arrow (3 times), press right arrow, Return, and type **PN**.

In the same way, protect the formulas that calculate the subtotal, discount, and total. Place the cursor on F11 and press OA-L. Now type **B** and press down arrow twice. Press Return and type **PN**.

The next step is to prepare for printing. Leave your cursor on F11 and press OA-O to bring up the Printer Options screen. Now set the left and top margins to position the spreadsheet on the printed page. Type **LM**, press Return, type **.8**, and

Figure 4. Practice entries in an AppleWorks quotation.

| Qty | Item # | Description | Unit Price | Extended Price |
|-----|--------|--------------------------|------------|----------------|
| 48 | 259 | Phillips Screwdrivers | | |
| 24 | 250 | Crescent Wrenches | | |
| 24 | 210 | Harris Drill Sets | | |
| 12 | 263 | Cartons 20d Common Nails | | |
| | | | Subtotal | |
| | | | Discount | |
| | | | Total | |

COPY II PLUS Version 6!

BRINGS YOU THESE PRODOS AND DOS 3.3 UTILITIES:

- Copy files, disks, even entire subdirectories.
- Alphabetize catalog.
- Undelete ProDOS and DOS files.
- Convert DOS to ProDOS & vice versa
- Fast 2-pass disk copy on Apple //e, //c or Laser 128.
- Tree display for selecting subdirectories - no need to type lengthy "prefixes"!

BACKUP YOUR PROTECTED SOFTWARE!!

With COPY II PLUS' fully automatic* bit copier, simply type in the name of the program you want to backup and COPY II PLUS does the rest! Parameters for hundreds of programs are right on disk! Also includes a track editor, sector editor and HI-RES disk display.

Supplied on a standard ProDOS diskette. Runs on Apple //, //+, //e, //c and Laser 128. Requires at least 64K and one or two disk drives.

For the Security of Backups and All the Disk Utilities You'll Ever Need...

COPY II PLUS, Version 6!!

**CENTRAL POINT
Software, Inc.**

9700 SW Capitol Hwy., *100
Portland, OR 97219

503/244-5782

M-F, 8-5:30, W. Coast Time



CHECK, COD WELCOME
(Prepayment Required)

\$39.95

plus \$3 s/h (\$8 overseas)

*We update COPY II PLUS as often as needed to handle new protections; you as a registered owner may update at any time for \$15 plus \$3 s/h.

This product is provided for the purpose of enabling you to make archival copies only.

Circle 60 on Reader Service Card.

Don't Miss "Halley's Comet & The Universe"

TRAVEL THE GALAXY WITH

VOLUME 11, NO. 5

UPTIMETM

THE MAGAZINE ON A DISK

©1985 Viking Technologies, Inc. - P.O. Box 299 - Newport, RI 02840 800-437-0033 - 401-849-4925

**SPECIAL
EDITION**
For the Apple II

TEN PROGRAMS AND MORE!

SOLAR SYSTEM · What do you know about our solar system? Which of the planets is called 'Earth's twin'? Which one has the most moons? Learn the answers to these and other questions — test your knowledge with this graphic program.

COMET QUIZ · So you think you know all there is to know about comets, eh? Well then try this educational game that challenges you to bring your lander down by getting the answer to a question. A fun way to learn about comets!

COMET HALLEY · For more than 70 years people have been awaiting the return of Halley's comet. Now it has returned. Learn about its history, its path and more. Great graphics make this tutorial fun to use.

STARCHART · You're ready to go out and search for Halley's Comet. Well, take a star chart along with you and print out a chart that shows both the comet and the constellations it passes through.

STAR TREK · Attention all Starship Captains! Your orders are to protect the universe from Klingon invasion. Your graphic ships are waiting in this month's Flip Side feature!

STRANDED · Your lunar lander has crashed on the moon. You can carry 15 things. What will you take to help you survive and be rescued? Based on actual psychological studies!

STARWATCH · Where is Halley's Comet? With this program you'll learn to spot the constellations that the comet will pass through and the path it will take as it flies by us.

STAR · Make fascinating star patterns on your hi-res screen. Are they simple stars or brilliant supernovas? With this program, the sky's the limit.

TREK · Can you zap the evil forces before they destroy your ship? You will be pitted against the base ship and its attack scouts. Will you survive?

LASER SHIELD · You have a powerful laser. Blow up the enemy before he can destroy your shields. A fun, hi-res game!

Ask about the ALL NEW Macintosh version!!

Get UPTIME at your local software store or bookstore, or call 1-800-437-0033 to order immediately.

I'LL BYTE!!! I'm a computer enthusiast who wants more. Please start my subscription to UPTIME now!

12 **Disk Issues** \$66.00 6 **Disk Issues** \$48.00 3 **Disk Issues** \$30.00 1 **Disk Issue** \$11.95

Check or money order enclosed. Payable to UPTIME
 Please bill my Visa MasterCard Exp. Date _____

Account No. _____
Signature _____

Name _____
Address _____ Zip _____

For all Apple II series computers.

press Return. Next, type **TM**, press Return, type **1**, and press Return again. Now press OA-S. AppleWorks saves the spreadsheet, then returns you to the Review/Add/Change screen.

Turn on your printer and follow these steps to start the Print command, confirm *All*, select the printer, enter a date, and confirm one copy. Press OA-P and Return. Then press Return (or type a printer number, then Return), type today's date, and press Return (2 times). Here's your copy of the Quote spreadsheet.

How an IF Formula Works

Making an IF formula switch from one answer to the other is a good way to test its workings. Remember, your customer receives a 5 percent discount on purchases of \$1500 or more, no discount for anything less. What if Nissen Brothers asked for a quote on six cartons of nails instead of 12? Place the cursor on A9, keep an eye on F12, type **6**, and press Return. Presto! Because the subtotal is now under \$1500, the number \$92.16 that was in F12 is now \$0.00. Leave the cursor on A9 and enter the original number by typing **12** and pressing Return.

Inserting Rows for More Entries

Clearly, you'll need more than four entry rows for some quotes. Let's insert three rows between rows 9 and 10. Place your cursor on A10 and press OA-I. Press Return, type **3**, and press Return again. Remember when you included the lines in Formula 3? It was just for times like this. Move the cursor to F14 and look at the

contents line. AppleWorks adjusted the subtotal formula to add the entries in F13 to F5.

The next step is to copy the price formulas into the new rows. Place the cursor on E9. Press OA-C, Return, press right arrow, Return, down arrow, type a period, press down arrow (2 times), and press Return. As you did before, tell AppleWorks which cells are *No change* and which are *Relative*. Type **R**, press Return (2 times), and type **R** (2 times). The formulas in the new cells have no numbers to work with, so NA appears. The subtotal, discount, and total formulas, because they are referring to cells containing NA, display NA too. To see the cells come to life, enter your quantities in A10 to A12 and item numbers in B10 to B12. If an item number is less than 210 or greater than 292, NA will remain in the cell. Try that, then replace them with legitimate item numbers.

Preparing the Spreadsheet for Another Quote

Let's say you are about to prepare a quote for another customer. It's easy to just blank out the existing entries and leave the labels, formats, and formulas intact. Start with the customer and RFQ number. Press OA-1 to jump the cursor to row 1 and press OA-B. Type **R** and press Return.

Now blank out the quantities, item numbers, and descriptions. Place your cursor on A6 and press OA-B. Type **B**, press right arrow (3 times), press OA-4, then press down arrow, and Return. Now you have a clean

spreadsheet awaiting the entries for the next customer.

This blanked spreadsheet is ideal to keep as a master to copy under a different file name each time you prepare a new quote. Name it QUOTE-MASTER and store it on disk. Leave your cursor on A6 and press OA-N. Press right arrow (5 times), type MASTER, press Return, and press OA-S. Now you have both versions on disk, giving you a choice of blanking out QUOTE each time or renaming and using the already blanked QUOTE-MASTER.

Lookup tables really make spreadsheet life simpler. They're easy to update, versatile (prices, freight charges, sales tax percentages, and discount rates), and can contain as many items as computer memory allows.

There are only two rules to follow in creating a lookup table: 1) The scan numbers (those a formula will look up) must be in ascending order. The corresponding numbers, though (those a formula will retrieve), may be in any order. 2) The scan cells and corresponding cells must be next to each other (no columns or rows in between). ■

Ruth K. Witkin is a consultant in computer applications for business. She is the author of Managing Your Business With Multiplan (Microsoft Press), Managing With AppleWorks (Howard W. Sams & Co.), Personal Money Management With Multiplan (Hayden Books), and Personal Money Management With AppleWorks (Hayden Books). Write to her at 5 Patricia Street, Plainview, NY 11803.

WE ARE NOT PIRATES!

but we're not fools, either.

We're serious programmers and software users who just want to have backup copies of any software we own. COMPUTIST magazine shows us how to make backups of commercial software regardless of the maker's attempt to stop us from having legal copies. Don't let them stop you from protecting your own rights.

Remove copy-protection

from your valuable library of expensive software. The publisher of COMPUTIST has been showing subscribers how to unlock and modify commercial software for the past 4 years. Don't be one of the users abused by user-FIENDLY locked-up software. Subscribe.

SUBSCRIPTION RATES FOR 6 ISSUES: U.S.: \$20, U.S. first class: \$24, Canada, Mexico: \$34, Foreign: \$60, Sample copy: US: \$4.75, other: \$8.00. US funds drawn on U.S. bank. In Washington add 7.8% tax. Send funds to:

COMPUTIST, PO Box 110846-I, Tacoma, WA 98411

NEW subscriber Renew my subscription

Name _____ 14

Address _____

City _____ State _____ Zip _____

Country _____ Phone _____

VISA/MC _____ Exp. _____

Signature _____

SCRG

SOUTHERN CALIFORNIA RESEARCH GROUP

INSTANT APPLEWORKS™

Now, you can have **APPLEWORKS™** built-in your APPLE //e™. With our programming service, your copy of **APPLEWORKS**, and the **quikLoader™**, your computer can be ready within 2 seconds after applying power.

After receiving your order, we will immediately send you a kit containing everything you'll need. (Units purchased through dealers will contain the kit). Copy your original **APPLEWORKS** program onto the disks included in the kit. Configure the program the way you want it used, and return it to us in the envelope provided. We will program the

necessary "chips", install them in the **quikLoader**, verify proper operation, and rush it to you. When you receive it, just plug it into any peripheral slot. No more searching for your disks, waiting for the startup disk to load, swapping to the program disk, and waiting even longer. The quikLoader is faster and more reliable than even a hard disk drive. Updates should be no problem, as the "chips" are re-programmable.

quikLoader— \$179.50
programming service— 89.50
Total— \$269.00

APPLEWORKS and APPLE //e are trademarks of APPLE COMPUTER INC.
quikLoader (designed by Jim Sather) is a trademark of S.C.R.G.

SEE A DEMO AT YOUR DEALER

SWITCH-A-SLOT



\$179.50

Designed by Joy George
The **SWITCH-A-SLOT** is an expansion chassis, which allows the user to plug in up to four peripheral cards in one slot. One of these cards is selected for use, and *only* that card draws power.

This product is especially useful where the software requires the printer to be in a particular slot, and the user wishes to choose between two or more printers.

SWITCH-A-SLOT and **EXTEND-A-SLOT** work well with most slow to medium speed cards, such as modems, printers, clock, music, etc. They are not recommended for high speed data transfer devices such as disk drive controllers, alternate processor, and memory cards. Due to the nature of these products, and unit-to-unit variations of computers and peripherals, we are unable to guarantee that these products will work with any particular system. However, as with all our products, we offer a ten-day trial period. If our product does not operate to your satisfaction, return it for a prompt refund.

EXTEND-A-SLOT

The **EXTEND-A-SLOT** brings a slot outside your APPLE™, allowing an easy change of cards. The 18" (45cm) cable is long enough to allow placement of the card in a convenient location. The high quality connectors are gold plated for reliability. **\$34.95**

SLOT 3 CLOCK™

Designed by Chuck Shaffer

The **SLOT 3 CLOCK** will plug into any slot of the APPLE][,][+, or //e. The main feature is that, unlike most cards, it can plug into slot 3 of the //e *without interfering* with the operation of the Extended 80-column card. **PRODOS™** is fully supported, and the card is **APPLESOFT™** compatible. Installation software and a long-life **DURACELL™** lithium battery are included.

\$79.50

PROMGRAMER™

Hardware design by Bob Brice

Software by Bob Sander-Coderick

The **PROMGRAMER** is an inexpensive **EPROM** (Erasable Programmable Read Only Memory) programmer for the APPLE][,][+, and //e computers. The unit plugs into any slot of the computer, and allows the user to program any standard 5 volt, 27 series **EPROM**. Although not intended as a production tool, the ease of use allows rapid programming, copying, duplication, or modification of **EPROMs**.

\$149.50

Paddle-Adapple

The **PADDLE-ADAPPLE** is a game plug expansion adapter that plugs into the interior game I/O socket, and is designed to operate in one of two modes. In the first, it allows you select between one of two devices, such as Koala Pad™ and joystick. The device is selected by the flip of a switch. In the second mode, the **PADDLE-ADAPPLE**, with appropriate software, allows the use of two joysticks simultaneously to allow use with games such as **ONE-ON-ONE™** and **ARCHON™**.

There are three versions to adapt to any combination of the newer type APPLE connector (the 9-pin 'D' sub-miniature), or the older 16-pin plug.

- The **PADDLE-ADAPPLE** has two 16-pin sockets.
- The **PADDLE-ADAPPLE COMBO** has one 'D' subminiature and one 16-pin connector.
- The **PADDLE-ADAPPLE 'D'** has two subminiature 'D' (9-pin) connectors.

\$29.95

9-16 Adapter for APPLE //e & //c

The 9-16 adapter permits the use of most 16-pin I/O devices with the APPLE //e or //c. Plugging this adapter into the subminiature 'D' connector allows the use of 16-pin device, such as the **PADDLE-ADAPPLE**, paddles, joystick, 16 pin Koala Pad™, etc. The only limitations are those devices that use the annunciators or the Ⓢ040 strobe. **NOTE**—the //c does not support two joysticks. **\$14.95**

16-9 Adapter for APPLE][and][+

With this adapter, owners of early APPLES can take advantage of the newer 9-pin game products, such as paddles, joysticks, **MUPPET LEARNING KEYS™**, etc. **NOTE** — If you have more than one game I/O device, consider purchasing our **PADDLE-ADAPPLE COMBO** or **PADDLE-ADAPPLE 'D'** instead. **\$14.95**

at your local dealer or direct from:
SOUTHERN CALIFORNIA RESEARCH GROUP

Post Office Box 593-R
Moorpark, CA 93020
Telephone (805) 529-2082

Telex: 658340 - SCRG (Intelnet SNC)

Shipping charges: U.S. & Canada \$2.50

Other: Switch-A-Slot; \$10.00 surface; \$25.00 air. Other products \$5.00 surface; \$10.00 air.

**SIX MONTH WARRANTY
TEN DAY RETURN PRIVILEGE
TOLL-FREE ORDER LINES**

NAT'L (800) 635-8310

CALIF. (800) 821-0774

Information (805) 529-2082

VISA & MASTERCARD ACCEPTED

SENSIBLE GRAMMAR™

Yes, just like your old English teacher, your Apple Computer can now check your papers for grammatical and many other writing errors. Don't be embarrassed or lose credibility because of simple typos and mistakes. And it's so easy and fast to do with **Sensible Grammar**.

SENSIBLE GRAMMAR

checks your grammar, capitalization, punctuation and abbreviations. It searches out phrases that are inconcise, vague, wordy or repetitive, as well as faulty, informal, pompous or sexist. It calls your attention to clichés and slang. It even allows you to enter your own personal trite and pet expressions and then lets you know every time you use them.



AppleWorks Compatible!

*Sensible Grammar and Sensible Speller ProDOS work with the following word processors, AppleWorks, AppleWriter ProDOS version (Apple Computer, Inc.), Format II Enhanced-ProDOS (Kensington Microware), Mouse Write (Roger Wagner Publishing), Word Juggler (Quark Inc.), Zardax-ProDOS (Computer Solutions) and others. Sensible Speller ProDOS also works with PFS:WRITE-ProDOS (Software Publishing, Inc.), Mouse Word (International Solutions), Word-Talk (Computer Aids) and WordPerfect (SSI Software). Sensible Speller W works with DOS 3.2 and DOS 3.3. AppleWriter (Apple Computers, Inc.), Bank Street Writer (Brodebund), Format II (Kensington Microware), Home-Word & Screen Writer (Sierra On-Line Inc.), PFS:WRITE-DOS (Software Publishing, Inc.), TCM-Wordstar (Digital Research Corp.-Micropro International), and others. Owners of trademarks indicated in parentheses: Black's Law Dictionary (West Publishing, Inc.), Stedman's Medical Dictionary (Waverly Press, Inc.).
†Note: GPM, Pascal and PFS:WRITE-DOS versions do not suggest correct spelling of words or allow immediate correction of misspellings.

do you exhibit a tendency to make punctuation errors?
Regardless of your skills, typographical errors occur.
Therefore Sensible Grammar

It Never Overrides Your Judgment

Sensible Grammar singles out possible mistakes or improper usage and then suggests a correct replacement word or phrase, but it always leaves you the option to accept or reject the suggestion.

A Perfect Complement

SENSIBLE SPELLER™ catches your spelling mistakes, utilizing its huge 80,000 word vocabulary derived from the official Random House Dictionary®. Like **Sensible Grammar**, it works with tireless efficiency. It displays misspelled words in context, suggests the correct spelling and allows immediate replacement of misspelled words with correct ones.

Black's Law Dictionary™, **Sensible Technical Dictionary™** and **Stedman's Medical Dictionary™** are also available separately on diskette for use with the Sensible Speller.

Sensible Grammar™ is available for \$99.95; Sensible Speller™ for \$125.00 in either the "IV" or ProDOS version; Sensible Technical Dictionary™ for \$99.95; and Stedman's Medical Dictionary™ for \$99.95. The three specialized dictionaries require the Sensible Speller. All programs are available separately and run on Apple® computers.

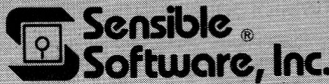

210 S. Woodward, Suite 229, Birmingham, MI 48011 • (313) 258-5566

Circle 84 on Reader Service Card.

BACK UP YOUR DISKS

EDD Version 4 is the most powerful copy program available for backing up "uncopyable" or "copy-protected" disks. ■ In addition to backing up disks, **EDD 4** also features a hi-resolution graphic DISK SCAN option to help you locate information on a disk, a CERTIFY DISK option for certifying blank disks, and since it's very important that your disk drives are running properly (especially when copying disks), we have also included an EXAMINE DISK DRIVE option. ■ Even though **EDD 4** has been preset to copy the broadest range of copy-protections possible, **EDD 4** can be "modified" to back up almost any disk that runs on your Apple! ■ For the dedicated user, in addition to **EDD 4**, we are offering an **EDD 4 PLUS** version that includes a specially designed hardware card which allows **EDD** to copy EVERY bit of information from each track accurately! You can bet that if **EDD 4 PLUS** can't copy it, nothing will! ■ **EDD 4** runs on an Apple II, II Plus (including most compatibles, IIe, IIc, and III (using emulation mode), and is priced at **\$79.95**. ■ **EDD 4 PLUS** runs on Apple II, II Plus (including most compatibles), and IIe, and is priced at **\$129.95** (duodisk/unidisk 5.25 owners must add \$15 for a special cable adapter). Ask for **EDD** at your local dealer, or to order direct, include \$3 (\$6 foreign) shipping/handling for **EDD 4**, or include \$5 (\$8 foreign) for **EDD 4 PLUS**. ■ Mastercard and Visa accepted. All orders must be prepaid. ■ If you have an earlier version of **EDD**, you can update to **EDD 4** or **EDD 4 PLUS** at a reduced price. Send your **EDD** disk to us, and deduct \$50 from your order.

EDD is sold for the sole purpose of making archival copies ONLY!

UTILICO MICROWARE

3377 SOLANO AVENUE / SUITE 352 / NAPA, CA 94558 / 707-257-2420

ESSENTIAL DATA DUPLICATOR 4

RIGHT OF ASSEMBLY

Branching Out

by Roger Wagner

Last month I started to explain various techniques for creating and using counters and loops in assembly language. To accomplish the loop, you use the value in one of the registers as a counter; the branch instruction (which tests for the presence of a nonzero number in the register) actually does the "looping." Recall that the zero bit or "flag" of the 6502's status register does this zero/nonzero evaluation.

Branching

The complement of the BNE instruction is something called BEQ, which obscurely enough stands for Branch Equal. It's the opposite of BNE in operation—branching only when the register or memory location reaches a value of zero. Consider

Listing 1. BASIC looping program.

```

10 HOME
20 X=255
30 PRINT X
40 X=X-1
50 IF X=0 THEN 70
60 GOTO 30
70 END

```

Listing 2. Assembly-language looping program.

```

1 *****
2 *      LOOP PROGRAM #2      *
3 *****
4 *
5          ORG   $300
6 *
7 HOME     EQU  $FC58
8 SCREEN   EQU  $05BC
9 WAIT     EQU  $FCAB
10 *
0300: 20 58 FC 11 START JSR HOME      ; CLEAR SCREEN
0303: A2 FF   12        LDX #$FF     ; START COUNTER AT 255
0305: 8E BC 05 13 LOOP  STX SCREEN   ; PUT CHAR ON SCREEN
0308: A9 80   14        LDA #$80     ; TIME DELAY VALUE
030A: 20 A8 FC 15        JSR WAIT
030D: CA     16        DEX           ; X = X - 1
030E: F0 03   17        BEQ DONE     ; DONE IF X = 0
0310: 4C 05 03 18        JMP LOOP    ; NEXT CYCLE
0313: 60     19 DONE   RTS          ; ALL DONE!

```

Branch instructions let you put loops into your assembly-language programs.

Listing 1 (a BASIC looping program), for example. The loop continues as long as X is not equal to zero. If it is, the program carries out the branch instruction and ends.

Listing 2 is the assembly-language equivalent of **Listing 1**. Notice that this program requires the JMP command, which causes program execution to jump to the routine starting at LOOP each time. Only when the X register reaches zero does the BEQ instruction take effect and make the program skip to the RTS instruction at the end.

Listing 3 is the way **Listing 2** appears when you put it into memory and list it with the L command from the Monitor (type 300L after the Monitor's asterisk prompt). When the assembler assembles the code, it automatically translates the positions of LOOP and END into the appropriate addresses the BEQ and JMP instructions will use. (Remember that the ad-

Listing 3. Listing 2 assembled.

```

0300- 20 58 FC JSR $FC58
0303- A2 FF   LDX #$FF
0305- 8E BC 05 STX $05BC
0308- A9 80   LDA #$80
030A- 20 A8 FC JSR $FCAB
030D- CA     DEX
030E- F0 03   BEQ $0313
0310- 4C 05 03 JMP $0305
0313- 60     RTS

```

dresses and the values for each opcode are to the left and the Apple's interpretation of these data is to the right.)

Notice that the JMPs and JSRs immediately precede the address (reversed) to which they are to jump, such as in the first JSR at \$300. The assembler handles branch instructions a little differently, however. At \$30E, \$F0 is the opcode for BEQ. The \$03 that follows is an offset that tells the 6502 to branch down through the code 3 bytes from the address of the next instruction (\$310). Adding \$03 to \$310 produces \$313, the address of the desired RTS.

Branching in the reverse direction ("up" through the listing) is also possible; operands greater than \$80 indicate this type of branching. I don't need to provide you with any great detail on this, though, since your assembler will determine the proper values for you when it assembles code, and Apple's disassembler gives the destination address when it reads other code.

This is a good time to stress the importance of working through each of these examples on your own, step by step. If the steps are confusing, go back over them until that proverbial light comes on!

Printing Text

As the assembly-language looping program increments the X register, it stuffs the value into the screen loca-

BOWL-KEEPER II

- outgrowth of BOWL-KEEPER
- widely requested features
- complete record keeping for the league secretary
- team and individual records many time-saving sorts
- 100 bowler capacity
- full edit capability

for Apple* II+, IIe, IIc
48K, 1 disk drive
printer recommended
\$49.95 (add \$3.00 s/h)
(Fl residents add sales tax)

Send check or money order to:

**CLAYTON &
ASSOCIATES, INC.**
P.O. BOX 6361
Clearwater, Florida 33518
COD (813) 797-7815

*Apple is a trademark of Apple Computer, Inc.

Circle 103 on Reader Service Card.

This Publication is available in Microform.



**University Microfilms
International**

Please send additional information

for _____
Name _____
Institution _____
Street _____
City _____
State _____ Zip _____

300 North Zeeb Road
Dept. P.R.
Ann Arbor, Mi. 48106

RIGHT OF ASSEMBLY

Listing 4. Revised looping program.

```

1 *****
2 *          LOOP PROGRAM #2B          *
3 *****
4 *
5             ORG   $300
6 *
7     CTR     EQU   $06
8     HOME    EQU   $FC58
9     COUT    EQU   $FDED
10 *
11 0300: 20 58 FC 11  START   JSR   HOME      ; CLEAR SCREEN
12 0303: A2 FF 12      LDX   #$FF          ; START COUNTER AT 255
13 0305: 85 06 13      STA   CTR          ; STORE IN 'CTR'
14 *
15 0307: A5 06 15  LOOP   LDA   CTR          ; GET CURRENT VALUE
16 0309: 20 ED FD 16     JSR   COUT        ; PRINT CHARACTER
17 030C: C6 06 17      DEC   CTR          ; CTR = CTR - 1
18 030E: F0 03 18      BEQ   DONE        ; DONE IF CTR = 0
19 0310: 4C 07 03 19     JMP   LOOP          ; GO AGAIN IF NOT
20 0313: 60 20      DONE   RTS           ; ALL DONE!

```

tion, so you can see something on the screen as the counter advances, but it prints text and numbers in a very limited way. Wouldn't it be nice to have a general text-printing routine available? Such a routine already exists within the Monitor routines at location \$FDED, and is labeled "COUT" (pronounced C-OUT for Character Output). You use COUT by loading the accumulator with the value for the character you want to print, then CALLING the routine.

The neat thing about using COUT is that you don't have to write your own routines to handle screen control—the line length, when to scroll, and so on. Better still, you can use COUT to send characters to a disk file or printer—more on that later.

Now comes a programming technique. You'd like to have the counter value in the accumulator so that you could print it via COUT, but, unfortunately, the increment/decrement commands work only for the X and Y registers and given memory locations. To solve this, you'll have to expand your listing a little. This time, you'll use a memory location as the counter, then load the accumulator on each pass through to print a visible sign of the counter's activity (Listing 4). It's important to avoid conflicts with the Apple's normal activities while running your own programs; \$06 to \$09 are good locations to use for experimenting because Integer, Applesoft, DOS, and the Monitor don't use them.

A call to this routine via the usual 300G from the Monitor or a CALL 768 from BASIC should clear the

screen, then print all your Apple's available characters, in all three display modes (normal, flashing, and inverse). You'll hear a beep when COUT "prints" control-G (bell) to the screen. The invisible control characters account for the blank region between the two main segments of output characters. If you have an Apple II or II Plus, you'll also see some characters that an Apple IIe or IIc doesn't normally generate, such as underscore, reverse slash, and the right square bracket (—, \,]).

The alphabet is backwards because the program started at the highest value and worked its way down. From last month, though, you'll remember that when a byte is incremented by one from \$FF, the result "wraps around" back to \$00. This produces an action BEQ can test. Using this wrap-around effect of the increment command, you can rewrite the program to be a little more conventional (Listing 5).

A CALL to this routine should print the characters in a more familiar manner. At last the programs are starting to do something interesting. It gets better!

Reading Game Paddles

Listing 6 lets you read a game paddle and use what you get back to print something to the screen. Granted, I'm not any more sure than you are of what benefit this might be, but it's guaranteed to be a new program in your library!

The Monitor contains the paddle-read routine Applesoft uses. You can use the routine by loading the X reg-

Listing 5. Completed looping program.

```

1 *****
2 *          LOOP PROGRAM #3          *
3 *****
4 *
5          ORG    $300
6 *
7 CTR      EQU    $06
8 HOME    EQU    $FC58
9 COUT     EQU    $FDED
10 *
0300: 20 58 FC 11  START   JSR    HOME    ; CLEAR SCREEN
0303: A9 00    12          LDA    #$00    ; START COUNTER AT '0'
0305: 85 06    13          STA    CTR    ; STORE VALUE
0307: A5 06    14  LOOP    LDA    CTR    ; GET CURRENT VALUE
0309: 20 ED FD 15          JSR    COUT   ; PRINT CHARACTER
030C: E6 06    16          INC    CTR    ; CTR = CTR + 1
030E: F0 03    17          BEQ    DONE   ; DONE IF BACK TO '0'
0310: 4C 07 03 18          JMP    LOOP   ; GO AGAIN IF NOT
0313: 60      19  DONE    RTS      ; ALL DONE!

```

ister with the value for the paddle you want to read, followed by a JSR \$FB1E. When the routine returns, the value of the paddle will be in the Y register. All you have to do then is grab it, stuff it in the accumulator, and do a JSR COUT.

When you CALL this routine, it quickly fills up the screen, then changes the stream of characters as you turn paddle zero. Depending on your propensity to be hypnotized, you may lose touch with the world for indefinite periods of time. At the inverse and flashing end, the program is remarkably good at stimulating migraine headaches in record time. Since the program has no test for an end, pressing control-reset is the only way to stop its infinite loop.

By carefully controlling the paddle, you can observe some interesting bits of character-output trivia. After the inverse and flashing range, for example, you should be able to stop the flow by moving into the control-character range. With sufficient dexterity, you should be able to lock onto the persistent beep of the bell (control-G). Shortly after this point, the screen will zip into motion when you hit the line-feed character (control-J) and, of course, also at the carriage-return character (control-M). What fun, eh! As normal character output returns when you pass the halfway point, you can delight in various patterns of screen filling. Why, you may even want to try writing your name by deft control of the paddle—child's play!

Returning quickly to reality here, it's worth mentioning that some problems in accuracy can arise from repeatedly reading the paddle so quickly. The analog circuits involved don't have

time to return to zero, and various problems creep in.

Also, you should be careful to look for conflicting use of the registers by the various routines you're CALLing. There's often no assurance that the Monitor routine you use won't clobber the register you're using for your own routine. In the case of the paddle and output routines, the content of the accumulator changes when it returns from the routine.

For the record, Listing 7 is a reasonable Applesoft facsimile of Listing 6. It's worth mentioning that the machine-language version takes 18 bytes, while the Applesoft one takes 38, not counting space the variable T uses. Execution speed may seem to be similar, but this is largely because of printing the characters to the screen. In most cases, machine execution is orders-of-magnitude faster.

Methods of Transfer

Before I end, I'd like to toss just a few more commands your way. In Listing 6, you have to go through a rather inelegant way of transferring the value from the Y register to the accumulator, using a temporary storage byte. Fortunately, an easier way exists. The four commands below transfer the content of the X and Y registers to and from the accumulator. There is no command to transfer directly between the X and Y registers themselves, however.

- TXA: Transfers the content of the X register to the accumulator
- TYA: Transfers the content of the Y register to the accumulator
- TAX: Transfers the content of the accumulator to the X register
- TAY: Transfers the content of the accumulator to the Y register

Do Your Taxes With Apppleworks?

Sure. TAXWORKS templates turn Apppleworks' spreadsheet into a tax-preparation program that

- o Performs 1986 tax calculations (1985 tax year) -- automatically
- o Enters data in relevant tax forms -- automatically
- o Computes alternatives to reduce your tax bill -- automatically
- o Prints IRS-acceptable schedules A,B,C,D,E,G,SE,W
- o Even estimates your taxes under federal tax reform

all for \$19.95, a small fraction of the cost of ordinary tax software. Easy to use; tutorial is included. Requires Apple IIc or 128K IIe; printer optional. Prompt shipment.

TAXWORKS

\$19.95 plus \$2 shipping/handling. In N.Y. add state/local sales tax. (Sorry, no bank card or COD orders.) PERSONAL FINANCIAL SERVICES
Box 1401, Dept. N
Melville, N.Y. 11747
(516) 261-8652

Circle 230 on Reader Service Card.

**WITHOUT UNIDOS,TM
YOUR UNIDISKTM JUST
WON'T RECOGNIZE
AN
OLD
FRIEND.**

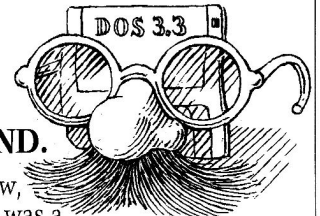

Until now, DOS 3.3 was a stranger to your Apple UniDisk 3.5. But no more!

UniDOS is DOS 3.3 for your UniDisk. It lets your UniDisk function as a dual 400k disk drive system while you work with your favorite DOS 3.3 programs and data.

Introduce UniDOS to your UniDisk right away. At \$35.00 they'll become fast friends.

meacom

P.O. Box 272591, Houston, TX 77277
(713) 526-5706, Telex: 4945935

VISA and MC accepted. UniDOS is written by David Hemmo and Marc Moini. For Macintosh Owners: Meacom also offers Mac + II, an AppleIIe emulator (128k, 80 column) for your 512k Mac or MacPlus. UniDisk 3.5 and Macintosh are trademarks of Apple Computer, Inc. UniDOS is a trademark of Meacom.



In less than 5 minutes, KITCHEN PLANNER will help you plan up to 14 days of balanced meals the way YOU want them and print the Menu and Shopping List.

★ EASY TO USE ★ SAVES TIME ★
★ SAVES MONEY ★

● "Saves 5-6 hrs a month and keeps our meals varied." - Family Computing Magazine Cover Story, November 1984.

● "The concept of this program is great for my family... I have only owned the program for 3 weeks and our shopping expenses have been reduced by about \$25 a week... that's great!" - Mrs. S., Illinois

● "This has been without a doubt the most useful disk I have purchased for my home computer." - Mrs. T., Wisconsin

SATISFACTION GUARANTEED

Send Check or Money Order to:

SAV-SOFT PRODUCTS

P.O. Box 24898

San Jose, CA 95154

(add \$1.50 handling; in CA add 6¼%)

VISA, MC call : (408) 978-1048

48K Apple II, II+, IIe, IIc, I disk, printer
Apple is a trademark of Apple Computer, Inc.

\$2995

Circle 223 on Reader Service Card.

Enhance AppleWorks™

DMP Utilities lets you use new character typefaces with AppleWorks. Now you can get Italics, Greek, Symbols, the highest quality typeface we've ever seen, and many other fonts, all from within AppleWorks!!!

24 Imagewriter Fonts 20 Epson FX/JX Fonts

DMP Utilities includes menu-driven software to download the character sets, and to eliminate printer control problems forever. You also get a character editor (full descender, proportional ability) and a program to convert some of the many hi-res character sets for printer use.

DMP Utilities is supplied on DOS 3.3, unlocked, and includes a 67 page User's Manual. Because the fonts are downloaded, they work with any program, not just AppleWorks. Our no-risk warranty provides you a full refund if you're not happy with the programs. The Utilities costs \$50 (+\$2 p/h). MC/Visa gladly accepted

DMP Utilities works ONLY with Apple DMP, Imagewriter I or II, and Epson FX or JX printers.

Apple Imagewriter Trademark of Apple Computer, Inc.
Epson is a Trademark of the Epson Corp.

Vilberg Brothers Comp. Inc.
4201 Hegg Avenue
Madison, WI 53716
(608) 221-0842

Listing 6. Game-paddle program.

```

1 *****
2 * PADDLE PROGRAM #1 *
3 *****
4 *
5 ORG $300
6 *
7 TEMP EQU $06
8 PREAD EQU $FB1E
9 HOME EQU $FC58
10 COUT EQU $FDED
11 *
12 START JSR HOME ; CLEAR SCREEN
13 LDX #$00 ; PADDLE = #0
14 LOOP JSR PREAD ; READ PADDLE
15 STY TEMP ; STORE RETURNED VALUE
16 LDA TEMP ; RETRIEVE VALUE
17 JSR COUT ; PRINT ASCII CHARACTER
18 JMP LOOP ; DO IT AGAIN
19 * INFINITE LOOP
    
```

Each of these actions conditions the zero flag upon execution, so it's possible to test what's been transferred.

You can use these commands to make Listing 6 even shorter (see Listing 8).

BRUNning from DOS

If you try to BRUN this month's programs using DOS 3.3, rather than using a CALL 768 from BASIC or a 300G from the Monitor, strange things will happen. DOS 3.3 interferes with any binary program that uses input or output routines when such a program is BRUN because DOS is always "watching" COUT for DOS commands, such as PRINT D\$; "CATALOG". When you BRUN a file, you're essentially in a DOS subroutine; further use of COUT makes DOS more or less forget where to return when everything is completed. This problem has two solutions. The first is trivial—don't BRUN files that use COUT. Instead, BLOAD the file, then CALL the routine in the usual way.

If you insist on BRUNning a file, however, the other choice is to exit

Listing 7. BASIC game-paddle program.

```

10 HOME
20 T = PDL(0)
30 PRINT CHR$(T);
40 GOTO 20
    
```

via a DOS reentry vector at \$3D0. A jump to this address replaces the final RTS in any program you want to BRUN. Replacing line 20 in Listing 4 with a JMP \$3D0, for example, lets you BRUN the file from DOS 3.3 with no problems. Please keep this in mind when running any other listing throughout this series.

See you in June! ■

Roger Wagner is the author of Assembly Lines: the Book and is president of Roger Wagner Publishing, the publisher of Merlin and MerlinPro assemblers. Write to Roger at Roger Wagner Publishing, 10761 Woodside Avenue, Suite E, P.O. Box 582, San- tee, CA 92071.

Listing 8. Revised game-paddle program.

```

1 *****
2 * PADDLE PROGRAM #1A *
3 *****
4 *
5 ORG $300
6 *
7 PREAD EQU $FB1E
8 HOME EQU $FC58
9 COUT EQU $FDED
10 *
11 START JSR HOME ; CLEAR SCREEN
12 LDX #$00 ; PADDLE = #0
13 LOOP JSR PREAD ; READ PADDLE
14 TYA ; PUT VALUE IN ACC.
15 JSR COUT ; PRINT ASCII CHARACTER
16 JMP LOOP ; DO IT AGAIN
17 * INFINITE LOOP
    
```

CLASSIFIEDS

Digitizers



COMPUTER EYES

- Make custom T-Shirts
 - Print computer portraits
 - Join "free" public domain ART GALLERIES
 - Capture real world images
 - Digitize video signals from: Video Tape Recorders (VCR's), Video Cameras, etc.
 - Hundreds of practical applications
- YES, I want my computer to "see"
YES, Send me ComputerEyes as follows:

Apple ComputerEyes 109.00
Software interface to:
Print Shop 12.00
Double HIRES (Ile), (Iic) 12.00
Newsroom 12.00
Panasonic/Ikegami Commercial grade BW video cameras ... 159.00
Special Hookup cabling with instructions 19.00
UNDERWARE ribbons to make custom heat iron-on transfers for T-shirts, scarves, etc 12.00
Color Pens 12.00
For VISA/MASTER CHARGE ORDERS. Call Toll FREE: 1-(800) 523-2445, x48) (PA Residents call 800-346-7511, x48) or Send Check/Money Order and all inquiries to:

HAL SYSTEMS
P.O. Box 293
Scotch Plains, NJ 07076

Please Note:
Prices include shipping & handling, (continental USA).
One year parts & labor warranty.
For COD orders, add \$5.00
NJ residents add 6%
AVAILABLE for APPLE, ATARI, C-64, AND IBM.
****Dealer Inquiries Invited****

Tax Software

AFFORDABLE TAX PROGRAMS
IRS-approved 1985 federal income tax programs for Apple II+, IIc, IIe. 1-2 drives. Printer-display-recall-save options. Values carried from form/schedule to another. Home Pkg. (1040, A, B, D, G, SE, W, 2441)—\$25.95. Office Pkg. (Home + C, E, F, 2210, more)—\$41.95. MO res.—add 5.725% sales tax.
CROWELL SOFTWARE CO.
5820 Bristlecone Ct.
St. Louis, MO 63129

Publications

MICROCOMPUTER BOOKS

Selected Apple II titles include:
*Apples for Teachers \$12.95
*Apple Logo for Kids \$8.95
*Apple II Basic Programs in Minutes \$11.95
*Basic Apple Basic \$15.95
*Data Base Management \$13.95
*Inside the Apple IIc \$17.95
*Inside the Apple IIe \$17.95
*Mastering Appleworks \$13.95
*Multiplan Models \$14.95
*Visicalc Models for Business \$15.95
*1001 Things to Do With Your Apple \$8.95

Shipping/Handling extra. MC/VISA/AE. Send for FREE Directory.

MICRO BOOKS
P.O. Box 4068
W. Richland, WA 99352
(800) 547-9755 Ext. 8
(509) 967-5084

Software

DESIGN YOUR OWN LABELS

For disks, name badges, video cassettes, photos, personal property, slides, parts, home canning, advertising, and more. Set height, width & lines-per-inch, then use our unique on-screen edit system to design a label. Edit lines and set formats until it's just right, then print 1 or 1000 copies. Add special "fill-in" fields and PRO LABEL will prompt for new data each time the label's printed. Do serial numbers. Use our prestored designs or make new ones. Requires 128K IIe/IIc & 1 drive. Program, user guide, and 100 free labels: \$19.95 + \$1 shpg. CHK/MC/VISA

PRO LABEL/AP
16 E. Main/P.O. Box 631
Marshalltown, IA 50158
1-800-634-5463

SPEED-UP HOME ACCOUNTANT

Speed up file processing 4-60 times, search 100 times faster, load report program in 40 vs 240 seconds, go directly from program to program, prompts you when splitting transactions, change check-books with a single keystroke, PLUS MORE. The 64K version supports hard disks, ramdisks, 120 categories, prints reports on 80 column card, etc. VISA/MC Accepted. Satisfaction Guaranteed. DOS 3.3 Only. \$19(48K)/\$24(64K) Plus \$2.50 Shipping/Handling
SOFTWARE SOLUTIONS
5516 Merritt Circle
Edina, MN 55436
For Orders Only 1-800-835-2246 Ext. 131

OUTLINER DEL CONDE

Develop outlines, \$39.95: intro price, quantity discounts. Enter ideas as they pop into your mind, then organize them quickly. Ideas can be gathered, split, moved, copied, erased, inserted, appended, and raised/lowered in importance; text processing too. For II+, e, c. -U/L case on e/c. 48K, 1 drive. Orders & inquiries to:

DEL CONDE VENTURES
41 Forrest Road
Randolph, NJ 07869

LOTTERY PLAYERS LOOK!!

You've got an edge in the Big Money State LOTTOS by using your computer to do a probability study of the past drawings. Don't waste your time with random numbers, this program performs an analysis of the past winning 6 digit numbers and tells you what numbers are due, what groups to play, any trends and much more! It's available on disk with instructions for all states and Canada. Most computer types \$19.95. The Super Macintosh Version is only \$29.95. VISA, MC, Checks, Fast Service!

SOFT-BYTE
COMPUTER PROGRAMS
P.O. Box 556 Forest Park
Dayton, OH 45405
(513) 233-2200

HYPER C COMPILER

For the Apple IIe, IIc. Macro Assembler, Overlay Linker, Debugging tools. Text Editor, Library w/source. Dual-Mode out-put, Native or Interpreted Code. K&R compatible. 188 page Users manual. We give you MORE C, ONLY \$43.95. \$6.00 shipping.

WSM GROUP, INC.
1161 N. EL Dorado #241
Tucson, AZ 85715
(602) 298-7910

Hardware

NEW APPLE PERIPHERALS

IIe 64K/80 Column Bd. \$39. Joystick II/IIc/IIc specify \$14.95. Mouse or Easy Pad Graphic Tablet w/software \$49.95. Cooling Fan II/IIe \$24.95. Add shipping \$3. COD \$2. Phone or Write for complete ill. price list.

NEXO DISTRIBUTION
8824 Golf Drive
Spring Valley, CA 92077
(619) 589-7928

Games

THE GODS HATE MAGICSOFT

They said it couldn't be done. We did it. Now, YOU can experience it. EXODUS CONSTRUCTION SET—The ONLY Ultima III SCENARIO editor \$28.50. (includes LAVALITE WORLD—A harsh new U3 scenario), WIZARDS WORKBENCH—The ONLY Wizardry III SCENARIO editor \$34.99. WIZI-SCOUT—inside scoop on all monsters/items \$20. ATOMIC WASTELAND—A NEW Wizi-scenario set in the future \$20. Call 800-628-2828 ext. 5202 Now to order (VISA/MC) or send CHECK, MO. FAST delivery. Money back Guarantee.

MAGICSOFT
P.O. Box 908-1
Danville, CA 94526-0908
(415) 820-0711

ATARISOFT FOR APPLE \$6 EACH

Pac-Man
Donkey Kong
Centipede
BUY ALL 3 ONLY \$15!
Add \$2.00 shipping and handling on orders under \$50.00.



ABBY'S SOFTWARE
37 South Broad St.
Fairborn, OH 45324
phone: (800) 282-0333 to order
VISA/MC

Continued from p. 43.

I used the LiveWire/Epson pair with a number of text programs, specifically Bank Street Filer and three different word processors: Magic Slate, MouseWrite, and WordPerfect. An option contained in the File menu lets you patch ProDOS on your word-processing or other application program disk, so files saved will be automatically time- and date-stamped. Since I did not want to alter my program disks, I did not test this feature.

Using LiveWire with graphics programs is a simple matter, as well. I worked with Dazzle Draw, The Print Shop, and Crossword Magic—all without incident. Other LiveWire options in the File and Graphics menus let you load a previously saved picture and print it in hi-res, double hi-res, inverted, rotated, centered, or magnified form. I used the many screen-dump features with pictures a friend had created and saved from Dazzle Draw.

As your picture is printed, you can see the progress on screen.

Documentation

The manual accompanying LiveWire seems adequate. Its 11 or so pages treat the installation and use of the product in a straightforward fashion. It contains no index, but the table of contents should suffice for reference purposes. Because serial-to-parallel conversion is likely to be a new concept for many users, a troubleshooting section would be a welcome addition to the documentation.

Support

Street Electronics' strong suit may be support. My first encounter with LiveWire was a frustrating one. Every time I tried to set the clock, the screen froze. I was unable to print anything from graphics programs. The Load Picture option was forever disabled. In short, the product had at least one bug.

Conversations with product developer Milo Street prompted him to

send me a newly corrected version of the software—by Federal Express. (After all, I was working under a deadline.) While the company probably could not afford the expense of using an overnight delivery service for the average user, I'm confident that the people at Street Electronics would answer customers' pleas for help with as much courtesy and concern as they did my entreaties. ■

*Cynthia E. Field
Wakefield, RI*

CORRECTION

In our January 1986 issue, the manufacturer of LockSmith is listed incorrectly (p. 29). LockSmith is now published by Alpha Logic Business Systems, 4119 North Union Road, Woodstock, IL 60098, (815) 568-5166.



BACKUP YOUR SOFTWARE WITH LOCKSMITH 6.0™.

Locksmith, the controversial copy program that took the Apple world by storm in 1981, has evolved from a powerful bit-copy program into a complete disk utility system, allowing the Apple user to recover crashed disks, restore accidentally deleted files, and perform hardware diagnostics on the disk drive and memory boards. The NEW Locksmith version 6.0 is now available and includes an advanced disk recovery utility, a framing-bit analyzer, an automatic boot tracer, a sector editor, many file utilities, and of course, the most powerful bit-copy program available. A fast disk backup utility copies disks in eight seconds flat. Improvements to Locksmith Programming Language have made it more powerful and easier to use for you to write your own backup and repair procedures. Includes a library disk which contains automatic procedures to copy hundreds of Apple programs.

Locksmith requires no additional hardware, but will use any additional RAM memory that it finds, including RAM boards from Applied Engineering and Checkmate Technology.

Don't get caught with your hands tied. Order Locksmith 6.0 today.

Does copy protection have your hands tied?



NEW LOW PRICE \$79.95

Registered Locksmith 5.0 owners may upgrade to version 6.0 for **\$29.95**.
Available from your computer dealer or directly from:



Alpha Logic Business Systems, Inc.
4119 North Union Road
Woodstock, IL 60098
(815) 568-5166



©Alpha Logic Business Systems, Inc. 1985
Locksmith and Locksmith/PC are registered trademarks of Alpha Logic Business Systems, Inc.

EXTRACT

A reprise of the reviews that have appeared in inCider in the last four months. Prices subject to change without notice.

inCider's Ratings

- ★★★★★ Excellent
- ★★★★ Above average
- ★★★ Good enough
- ★★ Not up to standard
- ★ The empty set

Hardware

Touch Window

★★★★
Personal Touch Corporation
4320-290 Stevens Creek Boulevard
San Jose, CA 95129
Touch sensitive tablet for your monitor,
March '86
\$199.95

Tymac MDD-640 Micro Disk Drive

★★★
Tymac Controls
129 Main Street
Franklin, NJ 07416
Limited—DOS 3.3 or ProDOS—and noisy
3½-inch disk drive for the II series,
January '86
\$399

UniDisk

★
Apple Computer
20525 Mariani Avenue
Cupertino, CA 95014
Cosmetic upgrade to the 5¼-inch Disk
II—143K, December '85
\$429, with controller
\$329, without controller

Software

Bank Street Mailer

★★★
Broderbund Software
17 Paul Drive
San Rafael, CA 94903
Letter writer and mail-list manager for
busy businesses and socialites,
February '86
\$69.95

Bataille de Mots and Snooper Troops: Sur les Traces du Deirdron

★★★
Gessler Educational Software
900 Broadway,
New York, NY 10003
Educational games for learning French,
March '86
\$49.95 each

Build a Book About You

★★★
Scarborough Systems
55 South Broadway
Tarrytown, NY 10591
Entertaining, if not educational,
personalized storybook for kids,
January '86
\$24.95

Kyan Pascal

★
Kyan Software
Department H
1850 Union Street #183
San Francisco, CA 94123
Two-pass compiler, faster than Apple's, but
needs work, December '85
\$69.95

MicroExpert

★
McGraw-Hill Book Company
Professional and Reference Division
1221 Avenue of the Americas
New York, NY 10020
Expert system development package,
March '86
\$49.95

Mouse Budget

★★★
International Solutions
910 West Maude Avenue
Sunnyvale, CA 94086
Tidy home-finance manager with a
friendly mouse, February '86
\$69.95

MouseWrite

★★
Roger Wagner Publishing
10761 Woodside Avenue, Suite E
Santee, CA 92071
Word processing with a mouse,
March '86
\$125

The Notable Phantom

★★★
DesignWare
185 Berry Street
San Francisco, CA 94107
Keyboard emulation and music games to
teach theory on the II, January '86
\$49.95

The Other Side

★★★
Tom Snyder Productions
123 Mount Auburn Street
Cambridge, MA 02138
Establish peace through trade between
warring nations, digital linkage,
January '86
\$69.95

Peterson's Financial Aid Service (\$195) Peterson's College Selection Service

(\$79.95)
★★★★
Peterson's Guides
P.O. Box 2123
Princeton, NJ 08540
Digital help with the selection and financ-
ing of a college education, December '85

PFS:Plan

★★
Software Publishing
1901 Landings Drive
Mountain View, CA 94043
Unintimidating, plain-Jane spreadsheet, 70
rows by 30 columns, February '86
\$125

Pro-Byter

★★★★
Beagle Bros
3990 Old Town Avenue, Suite 102C
San Diego, CA 92110
ProDOS and DOS 3.3 fun for program-
mers, utility, January '86-
\$34.95

P-Tral

★★
Woodchuck Industries
340 West 17th Street
New York, NY 10011
Translates Applesoft BASIC to Apple Pas-
cal for instruction or use, February '86
\$125

Quicken

★★★★
Intuit
540 University Avenue
Palo Alto, CA 94301
Quick and easy checking and finance for
the harried home or shop, February '86
\$79

Real Estate Analyzer

★★★
HowardSoft
1224 Prospect Street
Suite 150
La Jolla, CA 92037
Planning for your real estate investments,
March '86
\$295

Remember!

★
DesignWare
185 Berry Street
San Francisco, CA 94107
Memory training for drudge learning,
December '85
\$79.95

Standard & Poor's Stockpak II

★★★
CBS Software
One Fawcett Place
Greenwich, CT 06836
Repository of sound investment informa-
tion, December '85
\$150

Super Sofcrates: The Courseware Creator

★★★★
Simpac Educational Systems
1105 North Main Street
Gainesville, FL 32601
Innovative authoring system for noncom-
puterists to design educational software,
January '86
\$199

Think Fast

★
Brainpower
24009 Ventura Boulevard
Calabasas, CA 91302
Simple memory trainer, December '85
\$39.95

V-Color Graphics Tool Kit

★★★★
Video-7
550 Sycamore Drive
Milpitas, CA 95035
Applesoft graphics routines for double hi-
res programmers, 128K graphics driver,
December '85
\$49.95

Visible Pascal

★★★★
Wiley Professional Software
605 Third Avenue
New York, NY 10158
Gentle, fun, and colorful introduction
to Pascal, without compiler, December '85
\$59.95

Webster's New World Spelling Checker

★★★
Simon & Schuster
1230 Avenue of the Americas
New York, NY 10020
Easy-to-use spelling checker,
January '86
\$49.95

Willy Byte in the Digital Dimension

★★
datatrek
621 Second Street
Encinitas, CA 92024
Difficult play, but fun education in the basics
of computers, December '85
\$34.95

WordPerfect

★★★★
Satellite Software
288 West Center Street
Orem, UT 84057
Heavy-duty Apple version of popular IBM
word processor, March '86
\$179.95

ZBASIC

★★★
Zedcor
3438 Country Club Road
Tucson, AZ 85716
Compiled, transportable, structured pro-
gramming in BASIC, February '86
\$89.95

GAME ROOM

by Brian J. Murphy

In *Game Room*, Brian Murphy tells us what's new in the world of Apple games. Look here for inCider's scoop on the latest fun.

inCider's Ratings

- ★★★★ Excellent
- ★★★ Above average
- ★★ Good enough
- ★ Not up to standards
- ☆ The empty set

Perry Mason

★★★★

Telarium Corporation

One Kendall Square
Cambridge, MA 02139

Adventure

Any 64K Apple II with Applesoft,
one drive, DOS 3.3

\$39.95

From another era of TV history comes a fine game re-creating the Perry Mason series in high style. Who hasn't fantasized about being a heroic attorney standing in a courtroom, facing some weasely liar on the witness stand, and making him crack? In Telarium's **Perry Mason**, this is just what you can do.

The adventure begins with the murder of a prominent restaurateur, Victor Kapp, and the arrest of his wife Laura for the crime. The prosecuting attorney, the usually hapless Hamilton Burger, has a very strong circumstantial case against Laura and is about

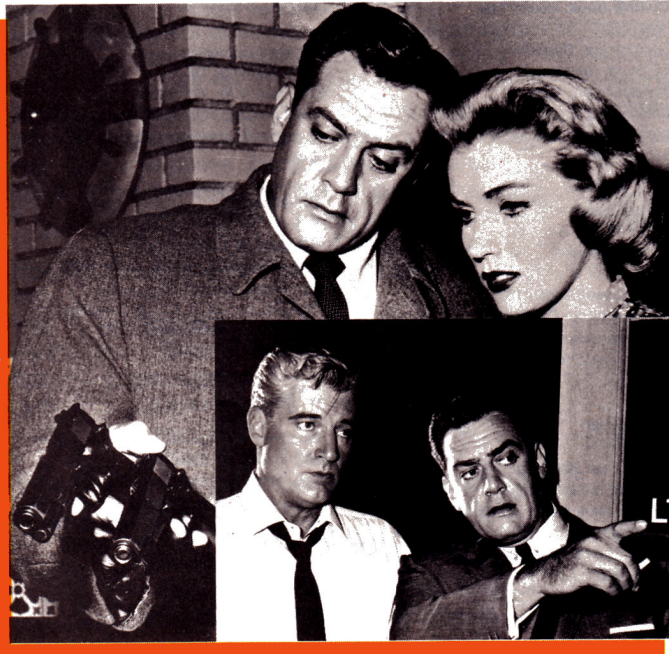

to embarrass you in court—unless you can bring all your skill as a detective and trial advocate to bear on the problem of finding the real killer.

Among your most important chores will be collecting clues at the murder scene and checking out every nook and cranny without provoking the police into tossing you out. You must also direct the investigations of your able secretary/assistant Della Street and detective Paul Drake into the behavior and motives of Victor Kapp's many friends and enemies—quite a few of whom were on the scene the night of the murder.

It was hard to quit playing the game long enough to write a review of it. The challenge of collecting clues is fun, and the trial sequence is absolutely fascinating. Early in my first try, I realized I didn't have nearly enough physical evidence from Paul's and Della's inquiries to win my case. Even though I was losing, I was having so

much fun I never wanted to stop. Getting the hang of courtroom procedure is fascinating. In the trial sequence, Perry Mason rises above the level of a top adventure game and becomes a totally entertaining courtroom simulation. This game deserves to become a best seller.

Star Trek: The Kobayashi Alternative

★★

Simon & Schuster

Computer Software Division
1230 Avenue of the Americas
New York, NY 10020

Text adventure

Any 64K Apple II with Applesoft,
one drive, DOS 3.3
\$39.95

If anyone were to come up with a truly exciting Star Trek game or simulation, I think the shock would kill me. For some reason, Star Trek seems to resist all attempts to translate it into really entertaining software.

Simon & Schuster's **Star Trek: The Kobayashi Alternative** is a case in point.

Wouldn't it have been really exciting if instead of an adventure game, Simon & Schuster (or anyone else) had compiled a simulation that integrated the visual elements of the Kobayashi game seen in the movie *Wrath of Khan*? No such luck—in fact, this Star Trek isn't illustrated, it isn't really about the Kobayashi game (hence the title), and it isn't much more fun than any of several other average-quality adventures I could name.

All that sets Star Trek apart from other science-fiction adventure games is the use of the Trek characters. This is one reason why *The Kobayashi Alternative*

Continued on p. 97.

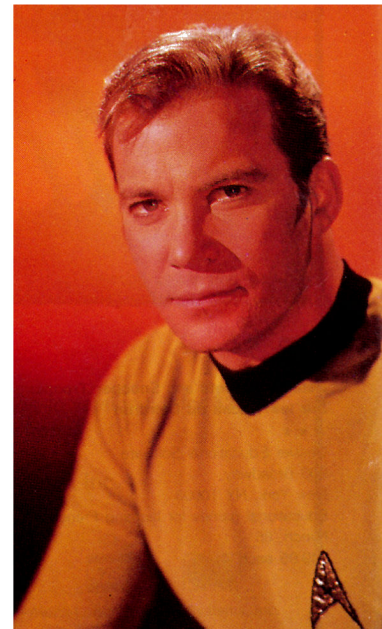

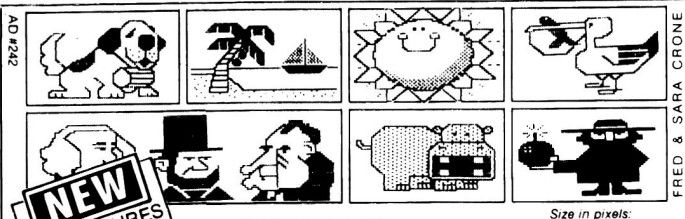

MINIPIX™ Disk #1
 \$29.95 (compatible with any Apple II—DOS 3.3 and ProDOS)

200 PICTURES ON DISK—FOR SHAPE MECHANIC, PRINT SHOP™, APPLE MECHANIC, ALPHA PLOT, BEAGLE GRAPHICS, and most other Apple-compatible hi-res graphics programs—Use pictures "as is", or create instant MIRROR IMAGES & BLOWUPS. Plus, convert part of any normal hi-res picture to PRINT SHOP™ format. PRINT SHOP™ owners: Use Minipix pictures directly on your greeting cards, banners and signs. SHAPE MECHANIC and APPLE MECHANIC fans: Use Minipix in shape table format for hi-res screen displays. ALPHA PLOT and BEAGLE GRAPHICS users: "Clip" Minipix images off the screen and "paste" them onto your own hi-res pictures.

"PRINT SHOP" is a trade mark of Broderbund Software, Inc.

NEW SHAPE MECHANIC™
 by BERT KERSEY & MARK SIMONSEN
 \$39.95 (any Apple II: DOS 3.3 & ProDOS)

Shape Mechanic is a lightning-fast remake of our Apple Mechanic and Typefaces disks, combined & rewritten to support ProDOS as well as DOS 3.3.



HI-RES SHAPE MAKER
 Shape Mechanic converts your hi-res drawings into "shape tables" so you can create title screens, charts and animation with Apple's built-in Draw & XDraw commands. "List & Learn" demos on the disk teach you how to create your own hi-res programs.

NO FEE to use Mechanic's routines in programs that you sell. Just give us credit. **SHAPE CAPTURE:** Convert all or part of any hi-res picture into a shape table.

HI-RES TYPE
 30 proportionally spaced hi-res screen display fonts (both large & small) are included on the Shape Mechanic disk. Every character may be edited to become any symbol.



SAMPLE TYPE: Most of these fonts were on our old "Typefaces" disk—in DOS 3.3 only.

All Beagle Bros disks are unlocked & copyable. Don't settle for less.

1 HOME INVERSE PRINT CHR\$(21)
 2 X=RD(1)*24+1:VTAB X:HTAB X:
 PRINT X:HTAB 26-X:PRINT X:GOTO 2

PRO-BYTER™
 by BERT KERSEY & JACK CASSIDY
 \$34.95 (Apple IIe/IIc or 64K II+ ProDOS)

BYTEZAP PRO: All NEW—Inspect ProDOS & 3.3 disks at the byte level. Make normally-impossible changes and repairs. Find any word in a disk or file. Repair zapped disk bytes and customize disks. Easy instructions show how to do it.

MACHINE-LANGUAGE SORT: One Call in your Applesoft program alphabetizes words—fast! Sorts string-arrays—A\$(1) etc. **MORE:** Save time & date in your catalogs. Catalog all directories on ProDOS disks. Swap Applesoft commands. TYPE text files without booting your word processor...

MACHINE LANGUAGE EDITOR: Type in programs from mags, and insert and delete. **ALL-NEW APPLE TIPS!** Use memory like an extra disk drive. Disable LIST so it says "File Locked". Disable/swap ANY command. Rename "Startup". Personalize catalogs...

NEW FONT MECHANIC™
 by MARK & JON SIMONSEN
 \$29.95 (any Apple II: DOS 3.3 & ProDOS)

30 all-new hi-res fonts for SHAPE MECHANIC and APPLE MECHANIC!

SAMPLE FONT MECHANIC TYPE:
 Old English CRATE FINE
 ZEBRA UNCLE BRANDING
 Caesar & HOLLYWOOD
 BELLS SANDWICH TIMES
 U.S. OPEN 2010N & X
 COUNTDOWN & ROOSEVELT
FONT UTILITIES: Convert other fonts (DOS Tool Kit™, etc.) into shape fonts. Adjust and distort (stretch, shrink, squish, etc.) for copy-fitting and special effects.

NEW CAT-MENU: Super high-speed; lets you select and execute ProDOS or DOS 3.3 files from menu with one keystroke.



NEW BIG U™

ProDOS™ UTILITY by RANDY BRANDT
 \$34.95 (Apple IIc, IIe or 64K II+ ProDOS)

FILE MOVER: (80-columns) Replaces Apple's Filer for ProDOS file transfer (not 3.3). Fast and friendly—no need to re-boot.

CRT WRITER: (80-col's, IIe or IIc only) Create fancy 80-column title screens. Or write & print short notes without booting up your word processor. Save screens on disk.

KEY-CAT 80: (80-col's) Hit ctrl-Reset to instantly see a disk's catalog in 80-columns. One keystroke runs or loads any program.

RAM LOAD: (IIc or 128K IIe) Auto-load files to and from RAM. Load all of your favorite programs into memory at once.

18 ALL-NEW ProDOS COMMANDS: (64K min., any Apple) COPY files from disk-to-disk. XLIST programs in better format. ANYCAT catalogs any DOS. MON monitors ProDOS. SHOW loads and shows pix. SEE lists disk programs without loading. **ERROR EDITOR:** Rewrite ProDOS's error messages ("Path Not Found", etc.).

INPUTTER: Accepts commas & colons, rejects control-characters. Esc to abort, etc. You pre-determine maximum string length.

REM-ZAPPER: Work with 2 versions of the same Applesoft program—one with Rem's and one without. Switch instantly. **MUCH MORE** including ProDOS versions of many Beagle UTILITY CITY programs.

TRIPLE-DUMP™
 by MARK SIMONSEN & ROB RENSTROM
 \$39.95 (any Apple II: DOS 3.3 & ProDOS)

PRINT ANY APPLE IMAGE: Use your dot matrix graphics-capable printer to print:
 1. Hi-Res and Double Hi-Res graphics
 2. Lo-Res and Double Lo-Res graphics
 3. 40- and 80-Column text-screen text.
 Print all kinds of images with absolutely no programming knowledge. OR call T-Dump routines from your Applesoft programs.
SPECIAL EFFECTS: Crop, rotate, magnify, compress, distort, adjust print density, etc.
GIANT BANNERS too: Print big signs and messages (8½" high letters) on any printer.

D CODE™
 by ALAN BIRD
 \$39.95 (any Apple II: DOS 3.3 & ProDOS)

PROGRAM PACKER: Compress Applesoft programs to increase efficiency. Combine program lines, shorten variables or remove Rem's. Find lines that won't execute.
AUTO-PROOFREADER: Errors are caught as you type, before a program is run.
SUPER-TRACE: When a program stops or crashes, type "DUMP" to look at the last 10-10,000 statements executed, in order.

"Live" tracing too, with each executing statement, line no. and selected variable value in a window at the bottom of screen.

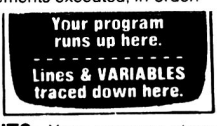

BREAKPOINTS: Your program stops when you want. For example, when X gets set to 99, or the 3rd time a Gosub occurs.
LIGHTNING-FAST FIND: Find strings & variables fast—search big programs in apx. 2 seconds—very useful! D Code is fully-transparent to your programs, and compatible with GPLE, Double-Take, etc.

EXTRA K™
 by MARK SIMONSEN & ALAN BIRD
 \$39.95 (IIc or 128K IIe: DOS 3.3 & ProDOS)

EXTRA VARIABLES: Applesoft programs run undisturbed in main memory while variables strings, etc., reside in the other 64K.
EXTRA APPLE: Have two 64K Apples & programs in memory (ProDOS & DOS 3.3 at the same time if you want). Switch at will.
EXTRA-FAST COPIES: "Nibble copy" and verify your unprotected disks in 35 seconds!
EXTRA FEATURES: Create combo 3.3/ProDOS disks. MANY MORE 128K utilities.
EXTRA SCREENS: Store all kinds of images in memory. Display any one instantly.



SHOW SEVERAL HI-RES PIX PER SECOND!

GPLE™
 by NEIL KONZEN
 \$49.95 (any Apple II: DOS 3.3 & ProDOS)

GLOBAL PROGRAM LINE EDITOR: The best, most popular Applesoft editor. Works like a word processor for Basic program lines.

INSERT AND DELETE: Quickly make changes to programs. No more awkward "escape-editing". No more hassles with extra spaces in quote statements. No more slow "cursor-tracing" to the end of a line.

SEARCH AND REPLACE: Find every occurrence of a string or variable in a program. Replace any word or variable too.

FUNCTION KEYS: Define your own—For example, ESC-1 can Catalog drive 1, ESC-N can clear the screen and type your name or anything... Customize your Apple!



Phone now for a free Beagle Bros Catalog.



24 Apple II software products under \$60.
 If you don't have your copy of our Winter/Spring 1986 catalog, phone toll free 1-800-227-3800 ext. 1607.

3990 OLD TOWN AVE., SAN DIEGO, CA 92110 (PHONE 619-296-6400)

GOTO YOUR SOFTWARE STORE.
 Or buy directly from Beagle Bros. WE SHIP FAST via First Class Mail.

- Alpha Plot \$39.50
- Beagle Bag 29.50
- Beagle Basic 34.95
- Beagle Graphics 59.95
- Big U 34.95
- D Code 39.95
- DiskQuik 29.50
- DOS Boss 24.00
- Double-Take 34.95
- Extra K 39.95
- Fatcat 34.95
- Flex Type 29.50
- Font Mechanic 29.95
- Frame-Up 29.50
- GPLE 49.95
- I. O. Silver 29.95
- Minipix Disk #1 29.95
- Pro-Byter 34.95
- ProntoDOS 29.50
- Shape Mechanic 39.95
- Silicon Salad 24.95
- Tip Disk #1 20.00
- Triple-Dump 39.95
- Utility City 29.50

Visa/MasterCard or COD, order Toll Free All 50 states, 24 hrs. every day (orders only)
1-800-227-3800 ext.1607

OR MAIL US A CHECK, MONEY ORDER OR VISA/MASTERCARD NO.

NAME _____
 ADDRESS _____
 CITY, STATE _____ ZIP _____
 CARD NO. _____
 EXPIRATION DATE _____

Add \$1.50 First Class Shipping, any size order
 Overseas add \$5.50—COD add \$3.00—Calif add 6%
 Mail to **BEAGLE BROS, DEPT. A**
 3990 OLD TOWN AVENUE, SUITE 102C
 SAN DIEGO, CALIFORNIA 92110
ALL ORDERS SHIPPED IMMEDIATELY.



**Special Apple Offer:
Arcade Games**
For the Apple II, II+ or IIe
\$215 worth of software
for only **\$59.95!**



Repton Price Was \$39.95

Will Star Fighter Armageddon arrive in time to save Repton? It's up to you.



Wavy Navy Price Was \$34.95

Fight enemy bombers, Kamikaze fighters, blazing machine guns... Hard to remember, it's just a game.



Buzzard Bait Price Was \$29.95

Help these citizens become something more than Buzzard Bait.



Plasmania Price Was \$29.95

Voyage through your patient's blood stream battling the body's defenses.



Type Attack Price Was \$39.95

Learn to improve your typing while defeating Lexicon with Letters!



Wayout Price Was \$39.95

You find the Way Out of 25 mazes - all in 3-D

This deal is too good to pass up, so hurry - supplies are limited.

All 6 Arcade Games for only **\$59.95** plus \$2.50 shipping and handling.

Games not sold separately. Check, Mastercard and VISA accepted.

CARNIVAL HOUSE

145 Grove Street
Peterborough, NH 03458
(603) 924-9882



| Reader Service | Page | Reader Service | Page |
|----------------|--|----------------|---|
| 61 | Advanced Logic Systems 23 | 12 | Interactive Microware 105 |
| 23 | Advanced Logic Systems 43 | 226 | Jacobsen Software Design 104 |
| * | Alf Products 107 | 28 | Legend Industries 62 |
| 199 | Alpha Logic Business Systems 92 | 241 | Manzanita Software Systems 78 |
| * | Applied Engineering 7, 29, 35, 58, 59, 60, 61, 73, 81, C11 | 248 | Meacom 89 |
| 243 | Applied Technology Labs 71 | 208 | Micro City 4 |
| 222 | AST Research 2, 3 | 206 | MicroProse 1 |
| 229 | Beagle Bros 80 | 100 | Nibble Notch 97 |
| 179 | Beagle Bros 95 | 110 | Northeastern Software 110, 111 |
| * | Business Computers of Peterborough 14, 15 | 192 | Norwich Data Services 105 |
| 235 | Carnival House 96 | * | Orange Micro 63 |
| 233 | Cauzin Systems 74, 75 | 120 | Orange Micro 65 |
| 60 | Central Point Software 82 | 52 | PBI Software CIV |
| * | Cheatsheet Products 68 | 247 | PM Software 42 |
| 227 | Checkmate Technology 8, 9 | 230 | Personal Financial Services 89 |
| 265 | Cirtech 20 | 133 | Pinpoint Publishing C11 |
| | Classified Ads 91 | 128 | Programs Plus 98, 99 |
| 103 | Clayton & Associates 88 | 155 | Quality Software 28 |
| 78 | Coit Valley Computers 77 | 16 | Quinsept 104 |
| 124 | CompuServe Information Services 40, 41 | 41 | Quorum Int'l Unltd. 12 |
| 76 | COMPUTIST 84 | 165 | Roger Coats 25 |
| 163 | Core Concepts 36 | 250 | Roger Wagner Publishing 34 |
| * | Covox 72 | 46 | Russ Systems 22 |
| 144 | Davka 69 | 223 | Sav-Soft Products 90 |
| 108 | Diversified Software 108 | 84 | Sensible Software 86 |
| 148 | Electronic Arts 18, 19 | 242 | Sensible Software 24 |
| 201 | Epyx Computer Software 37 | 143 | Silicon Express 66 |
| 245 | Firebird 38 | 218 | Sirtech 39 |
| 132 | First Class Peripherals 27 | 244 | Source, The 11 |
| 139 | Gutenberg Software Ltd. 26 | * | Southern California Research Group 85 |
| 229 | High Order Micro inCider Magazine 97 | 239 | Styleware, Inc 13 |
| | Classified Rates 97 | 156 | Sublogic 109 |
| | Subscriptions 32 | 15 | Uptime 83 |
| | Moving 108 | 264 | Utilico Microware 86 |
| | University Microfilm 88 | 135 | Vilberg Bros Computing 90 |
| | hotCider 64 | 116 | Wayne Green Int'l Ltd. 79 |
| 114 | Instant Software 101 | 72 | Wiley Professional Software 51 |
| | | 174 | Woodchuck Industries 107 |
| | | 270 | Writing Software Int'l Ltd. 31 |

For further information from our advertisers, please use the Reader Service card.

Advertising Sales: East Coast Office (603) 924-7138
West Coast Office (415) 328-3470

*This advertiser prefers to be contacted directly.

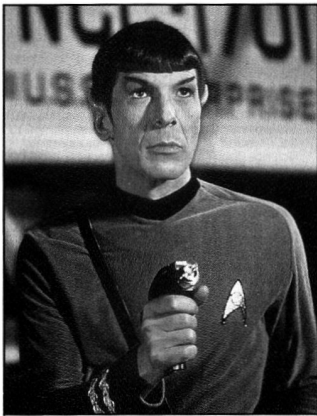

Continued from p. 94.

seems so disappointing—it fails to capture the essence of the characters. It's just an average sci-fi adventure with Trek characters grafted onto it.

It's a challenge to complete Star Trek's complex scenario, but not a pleasure. Its puzzles and obstacles are not so much inventive as petty and annoying. You're not impressed with the cleverness of the program as much as the many ways it stops you from really enjoying command of the *Enterprise*.

Star Trek didn't pass my most important test: It wasn't fun.

I'd advise waiting until someone comes out with a 128K Star Trek game that combines adventure (à la Infocom) and exciting tactical simulation (à la Sub-Logic's Flight Simulator II). That's the game we Trekkies are waiting for.

Temple of Apshai Trilogy

★★★

Epyx Computer Software
1043 Kiel Court
Sunnyvale, CA 94089
Fantasy/role-playing adventure
Any 64K Apple II with
Applesoft, one drive, DOS 3.3
\$40

Anyone who likes fantasy/role playing will have a soft

spot in his or her heart for Epyx' Temple of Apshai games—Temple of Apshai, The Upper Reaches of Apshai, and Curse of Ra. Though not as complex as Wizardry or Ultima, they offer a pleasurable combination of arcade action and strategy. These qualities kept the Apshai series at the top of the heap for a long time.

Even if you own one or two of the Apshai games, recommend you seriously consider getting the new, very much improved **Temple of Apshai Trilogy**, in which all three Apshai games are now on one disk.

Among the biggest enhancements are redesigned graphics. In fact, there are two complete sets. One group of pictures is in regular hi-res and is many times more attractive than the original set of Apshai stick figures. The optional pictures in double hi-res are strikingly handsome. Both sets of graphics offer much more color and better animation than the originals.

One advantage of consolidating these three adventures is that you can take your character on quests at any level of any of the three games. In effect, Epyx has built one mammoth game with 12 levels and nearly 600 different rooms—that's variety and challenge to spare. Apshai's back and I hope you get it.

What more could anyone ask? Next month we'll have a look at some new games and answer that question. Till then, aloha. ■

Brian Murphy is anxious to learn what you think of the current state of computer games. Write him at inCider, 80 Pine Street, Peterborough, NH 03458, and let him know your opinion.

Classified Rates

\$150.00 Per Issue (Minimum of Three Issues)
\$125.00 Per Issue (Minimum of Six Issues)
For Further Information, Call or Write:

inCider Classifieds
80 Pine St.
Peterborough, NH 03458

**IT'S LIKE
FREE DISKETTES**

Your 5 1/4" single side disks are usable on the other side. You paid for one side, why not use the other... **IT'S FREE!**

Nibble Notch will **open your new disk**. It's easy... won't harm existing data. Try it!

| | |
|--|--|
| <p>nibble notch I</p> <p>For Apple, Franklin, Commodore & Atari (w/Atari Drives); square notch.</p> <p>only \$14.95* <small>PLUS P&H</small></p> | <p>nibble notch II</p> <p>For all other computers; square notch & index hole.</p> <p>only \$21.90* <small>PLUS P&H</small></p> |
|--|--|

DISK OPTIMIZER II ©
Apple II Series Software
Pro DOS • DOS 3.3 • Pascal
Examines your **new disk**, locks out bad sectors and **certifies it 100% ERROR-FREE** in 30 seconds or less! Also checks drive speed...and more!

SUPER SAVER PACKAGE
Nibble Notch I and Disk Optimizer Combo (Optimizer alone reg. \$24.95)
\$29.95* FOR BOTH!

QUALITY DISKETTES low as 99¢

Toll Free 1-800-642-2536
1-215-527-1553
OR SEND CHECK OR MONEY ORDER TO:

707, Matson Ford Road, Villanova, PA 19085

* add \$2 (\$5 frgn) for P & H. PA Res. add 6% Sales Tax

U.S. PAT. 4,488,358

Computers

| | |
|--|--------|
| Apple Computer | |
| Apple // e Color & Mono Systems | Call |
| Apple // c Color & Mono Systems | Call |
| Macintosh 512K Computers | Call |
| Macintosh Plus Computers | Call |
| Central Point Software | |
| Lazer 128K Computer | 349.00 |
| <i>The Lazer 128 includes an Expansion Slot, RGB Video Output, Parallel Printer Port, an a 10 Key Numeric Keypad! Most Apple Compatible Computer Available at Any Price!</i> | |

BackUp Utilities/Boards

| | |
|--------------------------------------|-------|
| Alpha Logic Locksmith 6.0 | 65.00 |
| Applied Technology Laboratory | |
| Copy Master II 128K w/Gr. Dump | 94.00 |
| Central Point Software Copy II Plus | 20.00 |
| Wildcard II | 75.00 |
| Computer Applications | |
| Nibbles Away II/INADOL | 59.00 |
| Golden Delicious—CIA Files | 47.00 |
| Sensible Software—Back-TUP III | 45.00 |
| Utilico Software—E.D.D. III | 44.00 |

Entertainment

| | |
|--|-------|
| Access Software | |
| Beach-Head or Beach-Head II | 22.00 |
| Accolade Dam Busters | 20.00 |
| Hard Ball | 20.00 |
| Laws of the West | 20.00 |
| Pal 5 Trading Co. | 20.00 |
| Sundog V2.0 | 20.00 |
| Activision | |
| Alcazar or Master of the Lamps | 24.00 |
| Borrowed Time | 24.00 |
| Countdown to Shutdown | 24.00 |
| Cheese Busters or Pittfall II | 24.00 |
| Great American Road Race | 24.00 |
| Hacker or Space Shuttle | 24.00 |
| Little Computer People Discovery Kit | 24.00 |
| Mindshadow or Tracer Scansion | 24.00 |
| Star League Baseball | 19.00 |
| Avalon Hill Under Fire! | 36.00 |
| Avant-Garde | |
| Dave Winfield's Batter Up | 24.00 |
| Bantam Publishing | |
| Cave of Time or Escape | 22.00 |
| Fourth Protocol | 24.00 |
| 'Damiano the Wizard of Parastreda | 24.00 |
| Sherlock Holmes: "Another Bow" | 24.00 |
| Blue Chip Software | |
| Millionaire, Tycoon, Barron or Squire | 24.00 |
| Broderbund Ancient Art of War | 24.00 |
| Captain Goodnight & the Islands of Fear | 21.00 |
| Championship Lode Runner | 21.00 |
| Kartasia | 21.00 |
| Mask of the Sun or Serpent's Star | 24.00 |
| Where in the World is Carmen, San Diego? | 24.00 |
| DataSoft Alternate Reality | 29.00 |
| Bruce Lee, Conan, or Mr. Do | 23.00 |
| The Goonies or Zorro | 23.00 |
| Dallas Quest | 19.00 |
| Electronic Arts | |
| Adventure Construction Set | 32.00 |
| Archon II or One-On-One | 25.00 |
| Carriers At War or Wilderness | 32.00 |
| Europe Ablaze | 32.00 |
| Murder on the Zimdrumf | 14.00 |
| Music Construction Set | 25.00 |
| Pinball Construction Set | 22.00 |
| Reach for the Stars or Bard's Tale | 29.00 |
| 7 Cities of Gold or Skyfox | 25.00 |
| Software Golden Oldies | 22.00 |
| EPYX | |
| Bullblazer or Rescue on Fractulus | 24.00 |
| Summer Games II or Winter Games | 24.00 |
| Temple of Apehal Trilogy | 24.00 |
| World's Greatest Baseball | 21.00 |
| World's Greatest Football | 24.00 |
| Firebird Elite | 26.00 |
| Hayden Software | |
| Computer Novel Construction Set | 30.00 |
| Sargon III | 30.00 |
| Holy Grail or Inca | 30.00 |
| Infocom A Mind Forever Voyaging | 26.50 |
| Cruthrosts or Seastalker | 23.50 |
| Deadline or Starcross or SpellBreaker | 28.50 |
| Hitchhiker's Guide to The Galaxy | 23.50 |
| Infidel or Sorcerer | 26.50 |
| Witness, Planetfall, or Enchanter | 23.50 |
| Zork I or Wishbringer | 23.50 |
| Zork II, Zork III, or Suspect | 26.50 |
| Micro League Sports | |
| Micro League Baseball | 24.00 |
| General Manager/Owner Disk | 24.00 |
| Microprose | |
| Solo Flight or Nato Commander | 21.00 |
| F-15 Strike Eagle or Acrojet | 21.00 |
| Gunship or Silent Service | 21.00 |
| Crusade in Europe or Conflict in Vietnam | 25.00 |
| Mindscape | |
| Deja Vu: "A Nightmare Comes True" | 34.00 |
| James Bond: "A View To Kill" | 24.00 |
| Racter | 27.00 |
| Rambo: "First Blood Part II" | 24.00 |
| Stephen King's "The Mist" | 24.00 |
| The Halley Project | 27.00 |
| One Step Software Golf Best | 30.00 |
| Origin Systems | |
| Mobius | 37.00 |
| AutoDuel | 32.00 |
| Ultima III: Exodus or Ultima IV | 36.00 |
| Penguin The Quest or Ring Quest | 20.75 |
| Expedition Amazon or Xyphus | 20.75 |
| Sword of Kadesh or The Crimson Crown | 20.75 |
| Random House Alpine Encounter | 24.00 |

| | |
|----------------------------------|-------|
| Sierra-On-Line | |
| Kings Quest or King's Quest II | 30.00 |
| The Black Cauldron | 24.00 |
| Simon & Schuster | |
| Super Zaxxon or Frogger 3 Deep | 21.00 |
| Spy Hunter or Tapper | 27.00 |
| Sir-Tech Wizardry | 29.00 |
| Knight of Diamonds | 21.00 |
| Legacy of Lylgarnyn | 24.00 |
| Rescue Raiders | 21.00 |
| Wisprint | 15.00 |
| Spectrum Holobyte Gato | 22.00 |
| Synapse Software | |
| Brimstone, Mindwheel, or Essex | 27.00 |
| Strategic Simulations | |
| Baltic 85 or Gemstone Warrior | 20.50 |
| Battalion Commander | 24.00 |
| Battle For Normandy | 24.00 |
| 50 Mission Crush or Broadside | 23.50 |
| Geopolitique 1990 or Rails West | 23.50 |
| Germany 1925 or Carrier Force | 23.50 |
| Impromu Galactum | 23.50 |
| Kampfgruppe or Reforger 88 | 35.50 |
| North Atlantic 85 | 35.50 |
| Operation Market Garden | 30.00 |
| Objective Kursk or Phantasie | 23.50 |
| War in Russia | 47.50 |
| Sublogic Flight Simulator II | 31.00 |
| Tellurium Amazon or Dragon World | 24.00 |
| Fahrenheit 451 or Shadow Keep | 24.00 |
| Nine Princess in Amber | 24.00 |
| Perry Mason: Mandarin in Murders | 24.00 |
| Rendezvous with Rama | 24.00 |
| Windham Classics | |
| Below the Root or | |
| Swiss Family Robinson | 19.00 |
| Treasure Island or Wizard Of Oz | 19.00 |

Utility/Language Software

| | |
|--------------------------------------|--------|
| Apple Computer | |
| Apple II Instant Pascal | 105.00 |
| Apple Pascal V1.3 | 199.00 |
| Campanion Software Facelit 2 | 36.00 |
| Borland Turbo Pascal 3.0 | 39.00 |
| Turbo Database Tool Box | 31.00 |
| Tubo Tutor | 39.00 |
| Beagle Brothers Beagle Basic | 39.00 |
| Beagle G.P.L.E. | 27.00 |
| Big U | 19.00 |
| D-Code or Extra K | 22.00 |
| Disk Quick or I.O. Silver | 16.00 |
| Dos Bos or Silcon Salad | 13.00 |
| Double Take or Pro-Byter | 19.00 |
| Fat Cat | 19.00 |
| Pro-Byter | 19.00 |
| Pronto Dos or Utility City | 16.00 |
| Pronto Dump | 21.00 |
| Funk Software | |
| Sideways Prodos & Dos 3.3 | 32.00 |
| Lazerware Lisa V2.6 | 53.00 |
| Mescom | |
| UniDos (Dos 3.3 for the UniDrive) | 22.00 |
| Microsoft Applesoft Compiler | 105.00 |
| Basic Compiler | 239.00 |
| Quality Software | |
| Bag of Tricks II | 25.00 |
| Roger Wagner Merlin Pro | 57.00 |
| Merlin Assembler | 35.00 |
| Merlin Combo Pack | 64.00 |
| Software Masters | |
| Visible Computer: 6502 | 29.00 |
| The Byte Works | |
| ORCA/M Macro Assembler ProDos | 59.00 |
| Videx AppleWorks Modify Plus 84K | 39.00 |
| AppleWorks Modify Plus 128K | 49.00 |
| Vilberg Brothers | |
| DMP Utilities (ImageWriter or Epson) | 39.00 |

Graphics Packages

| | |
|--------------------------------------|-------|
| Activision Game Maker | 30.00 |
| Baudville | |
| Actors & Actions or Heros & Villians | 18.00 |
| Blaazing Paddles | 27.00 |
| Prince (C. Itoh or Epson) | 42.00 |
| Pixel | 29.00 |
| Shape Library 1, 2, or 3 | 12.95 |
| Take 1 | 32.00 |
| Beagle Brothers Beagle Graphics | 32.00 |
| Flex Text or Frame Up | 16.00 |
| Font Mechanic | 16.00 |
| Minipix Disk #1 | 16.00 |
| Shape Mechanic | 22.00 |
| Type Faces | 12.00 |
| Broderbund Dazzle Draw | 36.00 |
| Fantavision | 29.00 |
| Print Shop | 29.00 |
| Print Shop Companion | 24.00 |
| Print Shop Graphics Library | |
| I, II, or III | 14.95 |
| Print Shop Paper Refill | 12.95 |
| Data Transforms Fortrix 1.5 | 54.00 |
| Font Paks 1-13 ea. | 11.25 |
| Electronic Arts Movie Maker | 26.00 |
| Penguin Software | |
| New Complete Graphics System | 47.00 |
| The Graphics Magician | 35.00 |
| Simon & Schuster | |
| Great INTL. Paper Airplane | |
| Const. Kit | 22.00 |
| Springboard Newsroom | 32.00 |
| Newsroom Clip Art Collection Vol. 1 | 17.00 |
| Newsroom Clip Art Collection Vol. 2 | 21.00 |
| Graphics Expander Vol. 1 | 24.00 |

Communications

| | |
|------------------------------|--------|
| Apple Computer | |
| Access II (//e //c //g only) | 59.00 |
| CompuServe | |
| CompuServe Starter Kit | 21.00 |
| Microstuff Crosstalk | 102.00 |
| Quark Terminus //e | 69.00 |

| | |
|--|--------|
| Softronics Softform II | 124.00 |
| Software Publishing PFS: Access | 44.00 |
| Source Telecomputing | |
| The Source On-Line Information Network | 30.00 |
| United Software Industries | |
| ASCII: Express Pro: Prodos or Dos 3.3 | 76.00 |

Business Software

| | |
|---|--------|
| Advanced Logic Systems | |
| SpellWorks | 32.00 |
| The Handlers (//+, //e, //c) | 97.00 |
| Apple Apple Works (//e, //c) | 189.00 |
| Apple Writer II 2.0 ProDos (//e, //c) | 115.00 |
| Quickfile (//e only) | 75.00 |
| Applied Software Technology | |
| Versaform //e, //c | 48.00 |
| Arrays/Continental Software | |
| Home Accountant //e | 39.00 |
| Home Accountant //c | 42.00 |
| GLAR/AP Payroll ea. | 133.00 |
| Tax Advantages | 41.00 |
| Artcal MagiCalc ProDos | 79.00 |
| Magic Office System | 125.00 |
| Magic Window II | 79.00 |
| Bythe Software Omnisc 3 | 225.00 |
| BPI Systems | |
| BPI General Accounting Dos 3.3 | 199.00 |
| BPI AP/AP/PP or Inv. Dos 3.3 (ea.) | 199.00 |
| BPI General Accounting ProDos | 219.00 |
| BPI AP/AP/PP or Inv. ProDos (ea.) | 219.00 |
| Broderbund | |
| Bank Street Writer or Speller | 41.00 |
| Bank Street Filer or Mailer | 41.00 |
| CBS Software Stockpak II | 89.00 |
| Dow Jones Software | |
| Dow Jones Membership Kit | 19.00 |
| Electronic Arts Cut and Paste | 22.00 |
| Financial Cookbook | 32.00 |
| First Star The Works | 30.00 |
| Hayden Software | |
| The Writer | 27.00 |
| Human Edge Software | |
| Communications or Management Edge | 27.00 |
| Mind Prober | 27.00 |
| Mind Over Minors | 27.00 |
| Sales or Negotiation Edge | 27.00 |
| Howardsoft | |
| Real Estate Analyzer III w/Tax Preparer | 189.00 |
| International Solutions | |
| MouseBudget | 42.00 |
| MouseCalc | 92.00 |
| MouseDesk | 24.00 |
| MouseWord | 79.00 |
| Intuit Quicken | 49.00 |
| Kensington Microwave | |
| Format II Enhanced | 88.00 |
| Living Videotext | |
| Think Tank II - or //e | 79.00 |
| Manazita | |
| BusinessWorks | |
| System Manager (Required) | 69.00 |
| GLAR/AP or Inventory Control | 259.00 |
| Payroll Module | 295.00 |
| The Business Accountant | |
| System Manager (Required) | 69.00 |
| GLAR/AP or Inventory Control | 199.00 |
| Payroll Module | 229.00 |
| The Advanced Business Accountant | |
| System Manager (Required) | 69.00 |
| GLAR/AP or Inventory Control | 259.00 |
| Payroll Module | 295.00 |
| MECA Managing Your Money | 105.00 |
| MegaHaus MegaWorks | 69.00 |
| ReportWorks | 69.00 |
| Monogram | |
| Dollars and Sense (//+, //e) | 58.00 |
| Dollars and Sense (//c) | 68.00 |
| Forecast (84K or 128K) | 36.00 |
| Nofo Press Will Writer | 29.00 |
| Paladin Flashcalc | 59.00 |
| PBI Software Graphworks 1.2C | 59.00 |
| Jeeves | 38.00 |
| Peachtree | |
| Back To Basics: GLAR/AP | 105.00 |
| Pinpoint Publishing Pinpoint | 36.00 |
| PinPoint pop-up Spelling Checker | 36.00 |
| PinPoint Toolkit | Call |
| Practicalc II | 27.00 |
| Precision Software SuperBase | 59.00 |
| Quark Catalyst //e V3.0 | 59.00 |
| Word Juggler & Lexicheck //e | 59.00 |
| Roger Wagner Publishing | |
| Mouse Write | 75.00 |
| The Write Choice | 27.00 |
| Satellite Software Wordperfect | 79.00 |
| Sensible Software | |
| Bookends—ProDos | 79.00 |
| Graphics Department | 69.00 |
| Sensible Grammar | 55.00 |
| Sensible Speller—Dos or ProDos | 69.00 |
| Sierra On-Line | |
| General Manager II | 129.00 |
| Homeward Plus or Homeward File | 42.00 |
| Homeward Speller | 30.00 |
| Screenwriter Professional | 77.00 |
| Simon & Schuster | |
| JK Lasser's Money Manager | 49.00 |
| Software Publishing | |
| PFS: First Success | 128.00 |
| PFS:File, Graph, Report | 69.00 |
| PFS:Write or Plan (//e, //c) | 69.00 |
| Sorcim/IUS SuperCalc 3a | 105.00 |
| State of the Art | |
| Electric Checkbook | 59.00 |
| GLAR/AP/Inventory/Payroll | 289.00 |
| Stoneware | |
| DB Master Business Team | 189.00 |
| DB Master Business Writer | 89.00 |
| DB Master Version Four Plus | 169.00 |
| TimeWorks | |
| Silvia Porter's Financial Planner | 68.00 |
| Swiftcalc with Sideways | 105.00 |

Educational Software

| | |
|--|-------|
| Addison Wesley Smart Eyes | 36.00 |
| Apple | |
| Apple Logo II 128K (//e, //c only) | 79.00 |
| Bentam Books | |
| Fantastic Animals or Road Rally USA | 24.00 |
| The Complete Scarsdale Medical Diet | 24.00 |
| Baron's Computer SAT | 53.00 |
| Brainpower Chipwits or Think Fast | 24.00 |
| Broderbund | |
| Science Tool Kit Master Module | 36.00 |
| CBS Software Adventure Master | 26.00 |
| America Coast to Coast | 24.00 |
| Body in Focus | 24.00 |
| Dinosaur Dig | 24.00 |
| Forecast or T-Box | 29.00 |
| Goran's FrEx | 49.00 |
| Mastering The SAT | 59.00 |
| Success w/Algebra (ea.) | 21.00 |
| Success w/Math (ea.) | 15.00 |
| Davidson & Associates | |
| Alge-Blast | 28.50 |
| Classmate or Math Blaster | 28.50 |
| Speed Reader II | 40.50 |
| Speed Reader Data A, B, C, or D | 11.95 |
| Spell-It or Word Attack! | 28.50 |
| Designware | |
| European Nations & Locations | 26.00 |
| Grammar Examiner | 26.00 |
| Remember | 45.00 |
| Spellchecker or Spellakazam | 24.00 |
| States & Traits or Mission Algebra | 26.00 |
| The Body Transparent | 26.00 |
| DLM | |
| Alligator Mix or Demolition Division | 19.00 |
| Create with Garfield or Fraction Fuel Up | 19.00 |
| Freddie's Puzzles or Number Farm | 19.00 |
| Spelling Wiz or Word Invasion | 19.00 |
| Fisher Price | |
| Alpha Build or Logic Levels | 16.00 |
| First Man on the Moon | 18.00 |
| Peter Rabbit Reading | 18.00 |
| Golfer Publishing EduCalc | 30.00 |
| Gentle Filer or Easy Graph | 24.00 |
| Science Island or Treasure Hunter | 24.00 |
| Harcourt Brace Computer SAT | 46.00 |
| Learning Company | |
| Addition Magician | 21.00 |
| Humble Pict or Reader Rabbit | 24.00 |
| Gertrude's Puzzles or Secrets | 26.00 |
| Juggle's Rainbow | 18.00 |
| Magic Spell or Word Spinner | 21.00 |
| Mooptown Hotel or Number Stumper | 24.00 |
| Robot Odyssey or Rocky's Boots | 29.00 |
| Milliken | |

In Connecticut Call 378-3662 or 378-8293

| | |
|----------------------------------|-------|
| Weekly Reader Chivalry | 29.00 |
| Exploring Tables & Graphs 1 or 2 | 21.00 |
| Pic-BUILDER | 24.00 |
| Stickybear Series (ea.) | 24.00 |

| | |
|-------------------------------|--------|
| Modems | |
| Anchor Automation | |
| Signalman Express 1200 | 229.00 |
| Signalman Lightning 2400 | 349.00 |
| Volkmodem 12 | 179.00 |
| Apple Computer | |
| Apple Personal Modem | 279.00 |
| Apple II /e, /c, or Mac Cable | 25.00 |
| Hayes | |
| Hayes Micromodem I /e | 135.00 |
| Hayes 300 Baud Smartmodem /c | 155.00 |
| Hayes 300 Baud Smartmodem | 135.00 |
| Hayes 1200 Baud Smartmodem | 365.00 |
| Hayes 2400 Baud Smartmodem | 575.00 |
| Transit 1000 | 269.00 |
| Novation | |
| Novation Apple Cat II | 189.00 |
| Novation 212 Apple Cat II | 359.00 |
| Novation 212 Upgrade | 219.00 |
| Novation 2400 Baud | |
| Standalone Modem | 479.00 |
| Prentice | |
| Popcorn X-100 (1200 Baud) | 249.00 |
| Prometheus | |
| Pro Modem 1200 (External) | 269.00 |
| Pro Modem 1200A (Internal) | 239.00 |
| Pro Modem 300c | 129.00 |
| U.S. Robotics | |
| U.S. Robotics Password 1200 | 199.00 |
| U.S. Robotics Courier 2400 | 389.00 |
| Zoom Telephonics | |
| Zoom/Modem /e | 115.00 |
| Zoom/Modem /e Plus | 125.00 |

| | |
|---|--------|
| Accelerators/Ramcards/Z-80/80 Col. | |
| Advanced Logic Systems | |
| Add-Ram 18 | 65.00 |
| Add-Ram 80/64 | 52.00 |
| Add-Ram 80/256 | 145.00 |
| Z-Engine 2.2 | 125.00 |
| CP/M Card | 225.00 |
| Apple Computer | |
| Apple II Memory Expansion Card | 225.00 |
| Apple /e Extended 80 Col. Card | 115.00 |
| Applied Engineering | |
| RamWorks II (84K to 3MB) | Call |
| Z-Ram /c (256 or 512K) | Call |
| Ramworks RGB Option & 16 Bit Option | Call |
| TransWarp Accelerator | Call |
| ViewMaster 80 | 109.00 |
| Z-80 Plus | 109.00 |
| AppleLink Apricorn 64K Extend-It | 89.00 |
| Apricorn 16K Ramcard II+ | 68.00 |
| AST Research MegaRamPlus | Call |
| SprintDisk | Call |
| Caribbean Computer | |
| Extend 80 | 78.00 |
| Checkmate Technology | |
| Multiview 80/160 | 219.00 |
| Multiram CX Cards | Call |
| ESC-316 CX Kit | Call |
| Multiram /e Cards | Call |
| Multiram /EX 65C816 Card | Call |
| Information Appliance SwyftCard | 75.00 |
| Legend Industries | |
| Legend E' Card (84K to 1 MB) | Call |
| Legend S' Card (84K to 1 MB) | Call |
| Micro Sci Micro Sci 80/64e | 69.00 |
| Micro Sci 80/256e | 149.00 |
| Microsoft | |
| Microsoft Softcard II | 265.00 |
| MTC MTC Speed Demon | 159.00 |
| Titan Industries Saturn 128K Ram | 175.00 |
| Neptune 80 Col. w/84K | 185.00 |
| Accelerator /e | 219.00 |
| Vidax Videx Videoterm w/SS Inv. | 178.00 |
| Videx Ultraterm | 169.00 |

| | |
|------------------------------------|--------|
| Multifunction Cards | |
| AST Research Multi I/O Card | 155.00 |
| Checkmate Technology Gambit | Call |
| Prometheus VERSAcad | 135.00 |
| Quadram Multicore w/256K | 295.00 |
| Extended Multifunction Board | 179.00 |
| Street Electronics | |
| Business Card Parallel | 159.00 |
| Business Card Serial | 139.00 |
| Videx PSIO Dual Function Interface | 135.00 |

| | |
|--------------------------------|--------|
| Printer Interface Cards | |
| Apple | |
| Apple Super Serial Card | 109.00 |
| Apricorn Apricorn /c | 49.00 |
| Super Serial Card | 79.00 |
| Interactive Structures | |
| Passo/U Interface | 115.00 |
| Orange Micro | |
| Serial Grappler Plus | 75.00 |
| Grappler+ | 74.00 |
| Buffered Grappler+ | 135.00 |
| Grappler /c | 78.00 |
| Hot Link | 49.00 |
| Practical Peripherals | |
| Graphicard | 59.00 |
| PrinterFace | 49.00 |
| SerialLL Interface Card | 99.00 |
| Spice Labs Nice Print | 109.00 |
| TextPrint | |
| Print-It! (Parallel or Serial) | 125.00 |
| Thirdware | |
| Finger Print Plus II + /e, /c | 89.00 |

| | |
|-------------------------------------|--------|
| Clock/Calendar Peripherals | |
| Applied Engineering | |
| TimeMaster H.O. | 99.00 |
| BSR Interface | 39.00 |
| //c System Clock | 85.00 |
| Practical Peripherals | |
| ProClock /e or /c | 119.00 |
| Quadram | |
| Pro Dos Clock/Calendar Card | 65.00 |
| Creative Peripherals | |
| Seiko Datagraph 2001 w/Time Trax | 149.00 |
| Time Trax /e or /c | 79.00 |
| //c System Clock | 55.00 |
| Street Electronics Livewire w/clock | 72.00 |
| Thunderware Thunderclock | 105.00 |

| | |
|----------------------------|--------|
| Video Cards | |
| Video 7 | |
| Color Enhancer /e w/Dazzle | 119.00 |
| Draw | 89.00 |
| Color Enhancer /c | 89.00 |
| Screen Enhancer /e | 89.00 |
| Screen Enhancer /c | 49.00 |

| | |
|---------------------------------------|--------|
| Accessories | |
| Kensington System Saver | 60.00 |
| Cool + Time | 69.00 |
| Curt Diamond | 20.00 |
| Curtis Emerald | 36.00 |
| Curtis Ruby | 54.00 |
| Curtis Sapphire | 47.00 |
| Cauzin Strip Reader | Call |
| Touch Window by Personal Touch | 179.00 |
| Apple Mouse /e | 115.00 |
| Apple Mouse /c | 79.00 |
| Hayes Mach II Joystick | 27.00 |
| Hayes Mach III Joystick | 33.00 |
| Kraft Quickstick /c | 49.00 |
| Kraft Joystick | 31.00 |
| Digital Paintbrush System | 175.00 |
| Muppet Learning Keys | 42.00 |
| Koala Pad Plus | 72.00 |
| KeyTronic Keyboard KB-200 | 189.00 |
| Trackhouse Keypad | 79.00 |
| Mockingboard A Board | 69.00 |
| Mockingboard C Board | 119.00 |
| Mockingboard D Board (/c) | 129.00 |
| Echo II Plus | 94.00 |
| The Cricket /c | 115.00 |
| Hanzon Universal Data Buffer | 289.00 |
| Rainbow Paper Pak (300 sheets) | 12.00 |
| ImageWriter Ribbon-Black | 4.50 |
| ImageWriter Ribbon-Color | 5.00 |
| Environmental Software: Apple Skins | |
| Apple //c or //e w/Monitor II Cover | 19.00 |
| Apple //c w/Color Monitor Cover | 21.00 |
| Apple //e Professional System Cover | 23.00 |
| Apple //c, //e or UniDisk Drive Cover | 7.00 |

| | |
|----------------------------------|-------|
| Blank Media | |
| 5 1/4" Blank Media | |
| BASF 5.25" SS/DD (box of 10) | 10.50 |
| Elephant 5.25" SS/DD (box of 10) | 11.95 |
| Verbatim 5.25" SS/DD (box of 10) | 12.50 |
| Sony 5.25" SS/DD (box of 10) | 12.50 |
| Maxell 5.25" SS/DD (box of 10) | 13.50 |
| Nashua 5.25" SS/DD (box of 10) | 12.50 |
| Memorex 5.25" SS/DD (box of 10) | 13.50 |
| 3M 5.25" SS/DD (box of 10) | 16.95 |
| Dyan 5.25" SS/DD (box of 10) | 19.95 |
| 3 1/2" Blank Media | |
| BASF 3.5" DS/DD (box of 5) | 15.00 |
| Sony 3.5" DS/DD (box of 10) | 31.00 |
| Fuji 3.5" DS/DD (box of 10) | 31.00 |
| Verbatim DS/DD (box of 10) | 31.00 |
| Maxell 3.5" DS/DD (box of 10) | 31.00 |
| 3M 3.5" DS/DD (box of 10) | 31.00 |

| | |
|----------------------------------|---------------|
| Printers | |
| Apple | |
| ImageWriter II Color Printer | 459.00 |
| ImageWriter II 32K Buffer | 79.00 |
| ImageWriter II Cut Sheet Feeder | 175.00 |
| ImageWriter (Wide Carriage) | 475.00 |
| Brother HR-15XL | 329.00 |
| HR-25 | 459.00 |
| HR-35 | 679.00 |
| TwinWriter 5 | 859.00 |
| Fortia/Dynax | |
| DH45 Dual Head Printer | 659.00 |
| Citizen MSP-10 (160 cps) | 249.00 |
| MSP-15 (160 cps) | 369.00 |
| MSP-20 (200 cps) | 339.00 |
| MSP-25 (200 cps) | 509.00 |
| C.hoff ProWriter 8510 SP Plus | 329.00 |
| ProWriter 1500 SP Plus | 489.00 |
| Epson | |
| AP-80 (ImageWriter Compatible) | 269.00 |
| LX-90/90 | Call |
| FX-280 | 209.00/259.00 |
| For | Call |
| DX-10/20 | Call |
| JX-80 | Recent |
| LQ-800/1000/1500 Low/Low | Call |
| SQ-2000 | Prices |
| Judl 6000 Par. or Ser. | 179.00 |
| 6100 Par. | 345.00 |
| 6200 Par. | 509.00 |
| 6300 Par. or Ser. | 655.00 |
| NEC SpinWriter e.l.f. 360 | 379.00 |
| SpinWriter 2030P (20 cps) | 625.00 |
| SpinWriter 3530P (35 cps) | 989.00 |
| PinWriter P2-2P (180 cps) | 485.00 |
| PinWriter P3-3P (180 cps) | 695.00 |
| Okidata Okimate 20 Color Printer | 119.00 |
| Microline 182P | 215.00 |

| | |
|--------------------------------|---------|
| Microline 183P | 379.00 |
| Microline 182P | 339.00 |
| Microline 193P | 475.00 |
| Microline 192 Apple | 369.00 |
| Microline 193 Apple | 545.00 |
| Panasonic KXP-1091 | 229.00 |
| KXP-1092 | 349.00 |
| KXP-1582 | 399.00 |
| KXP-3131 | 249.00 |
| KXP-3151 | 379.00 |
| Silver Reed EXP-400P | 209.00 |
| EXP-500P | 199.00 |
| EXP-550P | 369.00 |
| EXP-800P | 659.00 |
| Star Micronics SG-10 (120 cps) | 219.00 |
| SG-15 (120 cps) | 379.00 |
| SD-15 (180 cps) | 339.00 |
| SR-10 (200 cps) | 449.00 |
| SR-15 (200 cps) | 585.00 |
| Toahlba P-1340 Parallel | 399.00 |
| P-341 Parallel Only | 759.00 |
| P-341 Parallel & Serial | 789.00 |
| P-351 Parallel | 1045.00 |
| P-351 Parallel/Serial | 1045.00 |

| | |
|--|---------|
| Disk Drives/Hard Disks | |
| Apple | |
| ProFile (10 Meg) w/Access. Kit | 1139.00 |
| Apple /c External Drive | 229.00 |
| Apple DuoDisk w/Accessory Kit | 449.00 |
| Apple UniDisk w/Controller | 279.00 |
| Apple UniDisk 3.5 w/Apple // Utilities | 359.00 |
| Apple UniDisk 3.5 w/Catalyst | 385.00 |
| Apple UniDisk 3.5 Accessory Kit (II + /e) 59.00 | |
| AST Research | |
| MicroStor 10MB Tape Backup Only | 629.00 |
| MicroStor 10 MB Hard Disk Only | 1329.00 |
| MicroStor 10MB Hard Disk w/Tape | 1899.00 |
| Corvus Systems OmniDrive Hard Disks | Call |
| H & M Disk Drive Services | |
| EquiDisk+ | 599.00 |
| 737K of storage on each Drive! Includes | |
| 2-5.25" Drives w/Controller, Power Supply & Cables, Apple DuoDisk Side By Side Design! | |
| Micro Sci A2 Full Height | 159.00 |
| A5 Slimline /e | 159.00 |
| A5 Slimline /c | 165.00 |
| Micro Sci C2 Controller | 49.00 |
| Miltec AD-1 Full Height /e | 139.00 |
| AD-3C Slimline /e or /c | 129.00 |
| Pice Products | |
| Apple Half-Height II+, /e, /c | 139.00 |
| Quark | |
| QC-10 Hard Disk /e, /c or Mac | 1029.00 |
| QC-20 Hard Disk /e, /c or Mac | 1379.00 |

| | |
|------------------------------|--------|
| Monitors | |
| Amdek | |
| Video 300G 12" Green Monitor | 115.00 |

| | |
|------------------------------------|--------|
| Video 300A 12" Amber Monitor | 119.00 |
| Color Monitor 300 (Composite) | 209.00 |
| Color Monitor 600 (RGB) | 385.00 |
| DVM III RGB Interface | 119.00 |
| Apple | |
| Color Monitor /e | 289.00 |
| Color Monitor /c | 289.00 |
| Panasonic | |
| TR120M1 HI-Res Green | 110.00 |
| TR120MD HI-Res Amber | 110.00 |
| DT3101 Dual Mode Color 10" | 185.00 |
| DTM140 10" Super HI-Res RGB | 389.00 |
| DTM140 14" Super HI-Res RGB | 319.00 |
| Princeton Graphics | |
| HX-9 9" RGB Color | 399.00 |
| HX-12 RGB 12" RGB Color | 419.00 |
| RGB-80 Interface | 145.00 |
| Selata | |
| SG-1000 Green | 105.00 |
| SA-1000 Amber | 115.00 |
| SC-1000 Composite Color | 149.00 |
| SC-200 RGB Color | 379.00 |
| SWI International Systems | |
| CVUE Flat-Panel Display /c | 389.00 |
| Taxan | |
| 115 12" HI-Res Green | 109.00 |
| 116 12" HI-Res Amber | 115.00 |
| 220 14" Composite Color | 209.00 |
| 610 12" HI-Res RGB Color (510x200) | 345.00 |
| 620 12" HI-Res RGB Color (640x200) | 385.00 |
| 410-80/64 RGB-II Interface | 169.00 |
| Teknika | |
| MJ-22 RGB Color Monitor | 289.00 |

Ordering Instructions

VISA AND MASTERCARD ACCEPTED

To order, call us anytime Monday thru Friday 9:00 to 6:00, Saturday 10:00 to 6:00. For fast delivery if ordering by mail, send cashier's check, certified check or money order. Fortune 1000 & Government checks honored immediately—Personal and other company checks allow 2 weeks to clear. Mastercard & Visa include card # & expiration date. Connecticut residents add 7.5% sales tax.

Shipping Charges: Software—\$3.00 Minimum charge U.S. Mainland. With C.O.D. shipments add an additional \$2.00 U.S. postal, APC, and FPO add 3% (\$5.00 Min.). Alaska or Hawaii add 6% (\$10.00 Min.). Canadian orders add 10% (\$15.00 Min.). Foreign Orders except Canada—Add 18% (\$25.00 Min.).

Hardware—Please call for shipping charges.

Our Policy: We do not guarantee machine compatibility. All products are new and include factory warranty, therefore ALL sales are final. Defective software will be replaced by the same item only. Defective hardware will be replaced or repaired at our discretion. Prices & availability subject to change without notice. Products purchased in error, subject to 20% restocking fee. All returns must have an authorization number. Call (203) 378-3662 to obtain one before returning defective products for replacement.



Visit Our New Showroom: Exit 32 Off I-95
 Station House Square
 2505 Main Street
 Stratford, Conn. 06497
 Telephone Hours: Monday-Friday 9-9;
 Saturday 10-9
 Showroom Hours: Monday-Friday 9-6;
 Saturday 10-6

Orders Only TOLL-FREE **1-800-832-3201**

MACINTOSH 512K/MACPLUS SYSTEMS CALL
 APPLE II E PROFESSIONAL SYSTEMS .CALL
 APPLE II C SYSTEMSCALL
 Up to 60% Off Retail

STATUS REPORT

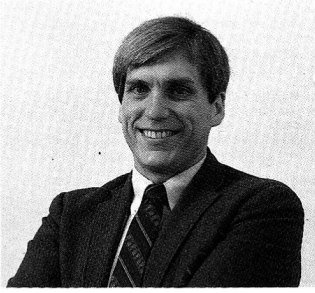

Interfaces

“A computer that complements the working of your mind represents truly radical ease of use. Does the Mac-style interface measure up?”

by Paul Statt, *inCider* staff

Once you understand the idea of a user interface, they seem to be staring at you everywhere. A *user interface* is the way you use a machine. Automobiles, for example, share a fairly standard interface: ignition key, steering wheel, mirrors and windshields, clutch pedal, and so on. You can drive a strange car because the way you drive—the user interface—is common to most cars.

If you've ever stood in a chilly shower in a hotel bathroom in a foreign city and wondered how to get hot water from a bizarre fixture resembling a nuclear submarine's periscope, you know the attraction of a standard interface.

A Macintosh-style interface—pull-down menus, icons, windows, and a cursor controlled by a mouse—will confront your Apple II screen this year. Apple has promised. The future of the II, we learned at the AppleWorld Expo in January, is a common interface and shared peripherals for all Apple products.

The Mac's great promise was “radical ease of use.” But don't get confused. Just because something is very easy to operate doesn't mean it will be useful or comprehensible.

A standard interface—of whatever type—would make every program written for the Apple IIe, Mac Plus, and any innovative machine Apple may offer this year easier to operate. But you might as well say that *Decline and Fall of the Roman Empire* is easy to read: It's a book written in English, and so is *Dick and Jane*. A standard interface makes things easy to operate, but not necessarily easy to understand.

Debbie de Peyster, *inCider's* editor in chief, has used a Macintosh (in the privacy of her home, of course) for years. She knows the Mac interface. Is Instant Pascal (see our review in this issue, p. 30) instantly easy for Debbie? Think Technologies, which created MacPascal, designed Instant Pascal to work just like its companion program. (It's the first official Apple software whose II and Mac versions have the same interface.)

Debbie knows how to operate Instant Pascal—but she doesn't understand Pascal

any better just because she can put the cursor where she wants it, find command menus, open and shut windows, and recognize the trash can.

A standard software interface, or any standard interface, is easy to operate by virtue of being common—if you know the standard. To a Chinese peasant, *Decline and Fall* is not only meaningless; he can't even read it—it's written in the wrong language and the wrong direction.

Uselessness is another problem. Mouse Budget, a fine personal-finance program from International Solutions, is easy for me to operate. But I do my taxes on the 1040EZ form—the one with “Send me back everything you withheld or tell my boss to give me a raise” on the bottom line. My finances are simple. No “radical ease of use” will make Mouse Budget meaningful—that is, useful—to me.

But the Mac interface purports to be fundamentally, philosophically, easy to use. That familiar screen with pictures and windows was developed by Xerox's Palo Alto Research Center. Its design is not arbitrary, but patterned after the way your mind works, especially your short-term memory and the right hemisphere of your brain. You can keep up to about seven unrelated items—say, a phone number or zip code—in your head at one time. The Xerox interface compensates for your weakness by keeping all possible commands on screen at the same time. Some of us favor our right brain, which likes pictures and shapes. The Xerox interface lets you see ideas graphically, in icons or on the desktop.

A computer, or hardware or software, that complements the working of your mind represents truly radical ease of use. You may find, for instance, as I do, that Information Appliance's SwyftCard (see Editors' Choice, January 1986, p. 128) is simple in operation and useful in doing its job, and fits your mind.

Does the Mac-style interface measure up? That answer is up to you. It will be the Apple standard, and as a standard will be easy to operate. It may even work like your mind. But before you buy a particular software package—or a new computer—don't forget to ask, “Will it do the job?” ■

**AVOID THE CROWDS
AND THE LAST MINUTE RUSH
AND PLACE YOUR ORDER**

SPRING IS JUST AROUND THE CORNER!

NOW!!

FREE SOFTWARE—For A Limited Time Only!!!!
Yes, that's right. We will give you a "KNOW YOUR APPLE" program absolutely free with any size purchase. This offer is good until quantities run out, so order now and get your free software program today.....

WE KNOW OF NO BETTER DRIVE AT ANY PRICE!!!!!!

..... **Another Incredible PICO Product.....**
Look at this great half-height 100% APPLE compatible disk drive. Suggested List Price \$269.95. Instant Software priced at only **\$189.95.**

| Disks 5 1/4" | List | Sale |
|---|-------|----------------|
| Sentinel DS/DD COLOR 10/box | 39.95 | 19.95 ☐ |
| Ultra Magnetics BONUS Pack DS/DD 12/box | 39.95 | 22.90 ☐ |
| CDC SS/DD 10/box | 31.95 | 9.95 ☐ |
| CDC DS/DD 10/box | 39.95 | 10.95 ☐ |
| Data Matrix 10/box | 44.91 | 11.95 ☐ |
| Dysan DS/DD 10/box | 49.95 | 33.95 ☐ |

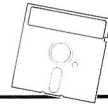

| | List | Sale |
|---|-------|----------------|
| Datarack Head Cleaning Kit | 15.95 | 12.95 ☐ |
| Head Cleaning Kit (c2017) | 16.99 | 7.95 ☐ |
| Datamatrix Head Cleaner | 6.99 | 4.95 ☐ |
| Anti-Static Spray Textwpe | 5.95 | 4.95 ☐ |
| Checkmate Anti Static | 3.88 | 2.95 ☐ |
| Disk Pac 3 1/2" Blue and Black | 14.95 | 7.95 ☐ |
| Disk Pac 5 1/4" Blue and Black | 13.95 | 6.99 ☐ |
| Disk File (6) | 2.95 | .99 ☐ |
| Teak Rolltop Disk Storage (5 1/4" holds 50) | 32.95 | 18.95 ☐ |
| Teak Rolltop Disk Storage (3.5 holds 45) | 23.95 | 14.95 ☐ |
| Data Defender 70 (5 1/4" holds 70) | 26.95 | 14.95 ☐ |
| Data Defender 15 (5 1/4" holds 15) | 4.49 | 2.99 ☐ |
| Flip n' File 50 (5 1/4" holds 50) | 19.95 | 9.99 ☐ |
| Cassette Storage (6) Black and Blue | 4.99 | .99 ☐ |

We know of no better disks at any price. DOLLAR DISKS!!!

- Quality Sentinel brand 5 1/4" disks
- Reliable, lifetime warranty
- SS/DD only \$1.00 each
- DS/DD only \$1.15 each
- Any quantity



Brother HR-10 Daisy Wheel Printer FINALLY! A Letter Quality Printer at a PRICE you can AFFORD.....
List price 349.00 **YOUR LOW PRICE ONLY \$299.00***

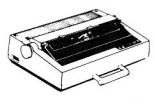

The HR-10 is designed to keep pace with modern computing needs by producing sharp, beautiful letter quality text. Thanks to a 2k bytes buffer and bidirectional printing, HR-10 gets everything onto the page quickly and accurately. The sprocket wheel feeder TF-10, which keeps fanfold paper flowing smoothly and efficiently, is standard equipment. And a shadow print feature lets you highlight words or phrases so they stand out from the rest of the text. Other features such as superscript and subscript, auto-underline and carriage skip movement provide versatility usually found on more expensive models.

| | List | OUR LOW PRICE* |
|--------------------------------|--------|-----------------|
| Brother HR-15 Letter Quality | 599.00 | 349.00 ☐ |
| Olympia-RO Letter Quality | 429.00 | 289.95 ☐ |
| Epson Homewriter Dot Matrix | 269.00 | 219.95 ☐ |
| Epson LX-80 NLQ Dot Matrix-NLQ | 299.00 | 249.95 ☐ |
| Epson FX100 Dot Matrix | 849.00 | 549.95 ☐ |

| Monitors | List | Sale |
|--------------------------------|--------|-----------------|
| Sanyo DMC 5500 Color Composite | 359.00 | 229.95 ☐ |
| Sanyo DM2112 Green | 118.00 | 79.95 ☐ |
| Sanyo DM2212 Amber | 118.00 | 79.95 ☐ |



The benefits of owning this drive to you are:
•Faster, more precise tracking and larger capacity than standard Apple drives.
•Quieter and smoother running.
•100% Apple compatibility for II+, IIe, and IIc external drives.
•Half-Height, compact design... saves you space.
•ONE YEAR WARRANTY.
•30 day moneyback guarantee.

Software SUCH A DEAL BARGAINS
All Titles only **\$9.99**

| | |
|---------------------|-----------------------|
| Adventureland | Electronic Breadboard |
| Apple Clinic | Mortons Fork |
| World Scrambler | Mystery Fun House |
| Caverns of Callisto | Savage Island |
| Skybombers 11 | The Russian Disk |
| Capitalization | Algebra II |
| Santa Paravia | Acey Ducey |
| Voodoo Castle | Merlin |
| Ghost Town | Routine Machine |
| Oil Tycoon | |

MORE items at fantastic SAVINGS...

| | List | Our Price |
|-------------------------|-------|----------------|
| Cut Throat | 39.95 | 24.95 ☐ |
| Enchanter | 39.95 | 24.95 ☐ |
| Bank Street Writer | 69.96 | 39.95 ☐ |
| All Keyfax Products | 12.95 | 5.95 ☐ |
| Prodos | | |
| Multiplan | | |
| Applewriter IIe | | |
| Visicalc | | |
| Keyboard cover | 9.95 | 4.95 ☐ |
| Bank Street Storybook | 39.95 | 24.95 ☐ |
| Microzone for Apple IIe | 39.95 | 13.95 ☐ |
| Archon | 40.00 | 24.95 ☐ |
| Cut & Paste | 35.00 | 14.95 ☐ |
| Financial Cookbook | 35.00 | 29.95 ☐ |
| Desecration | 37.95 | 9.95 ☐ |

| | | |
|----------------------------|-------|----------------|
| The Last Gladiator | 35.00 | 9.95 ☐ |
| Basic Tricks for the Apple | 24.95 | 13.95 ☐ |
| Learn Apple Logo | 19.95 | 14.95 ☐ |
| Night Flight | 24.95 | 19.95 ☐ |
| HARD HAT MACK | 35.00 | 12.95 ☐ |
| Sky Fox | 40.00 | 24.95 ☐ |
| Murder on Zinderneuf | 40.00 | 24.95 ☐ |
| Seven Cities of Gold | 40.00 | 24.95 ☐ |
| Routine Machine | 29.95 | 9.95 ☐ |
| Merlin Apple IIe | 30.95 | 9.95 ☐ |
| Copycat Apple IIe | 29.95 | 10.95 ☐ |
| Sampler 1 | 29.95 | 11.95 ☐ |
| Array | 29.95 | 11.95 ☐ |

| | | |
|--|-------|----------------|
| Pico Products Joysticks for ALL Apples | 39.95 | 21.95 ☐ |
|--|-------|----------------|

| Modems | List | Our Price |
|-------------------|--------|----------------|
| Anchor Mark x | 159.95 | 99.95 ☐ |
| Anchor Volksmodem | 72.88 | 49.95 ☐ |
| Black Jack | 49.95 | 25.95 ☐ |

GLARE GUARDS FOR YOUR CRT
These screens are available for color or mono (please specify).
•Fine nylon mesh•Easy attachment with velcro strips
•Reversible black or cream color•prevents dust accumulation
Only 19.95 for 12" and 24.95 for 14"

Universal Joystick for PICO PRODUCTS
This great joystick will work with an Apple II, II+, IIe or IIc and comes complete with:
•2 operating modes to give you "Auto-Centering" or "FreeFloating."
•2 pairs of fire buttons for the left or right-hand user.
•New quick fire button!
•ONE YEAR WARRANTY, 30-day money back guarantee.
•Easy to use and extremely durable. List 39.95 **Sale 21.95**

Protect Your Software FLIP 'N' FILE /15
Protect Software from dust, debris and moisture. Stores up to 15 5 1/4 diskettes.
List Price \$9.95 **Sale \$7.95**

Also Available

| | LIST | SALE |
|-------------------|---------|------------------|
| Flip 'n' File /50 | \$19.95 | \$14.95 ☐ |
| Data Defender /35 | \$ 9.95 | \$ 7.95 ☐ |
| Data Defender /70 | \$26.95 | \$19.95 ☐ |
| Roll Top /100 | \$49.95 | \$39.95 ☐ |



Kill Spikes, Fight Surge! MAXI Strip
Protect Valuable electronic equipment and data files from damage. Surge and spike suppressor and noise combination converts one outlet into six.
List \$34.95 **WOW!!! only \$19.95**

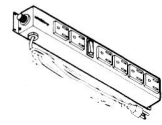

Also save on surge suppressors by CURTIS...

| | List | SALE |
|----------|---------|------------------|
| Diamond | \$49.95 | \$39.95 ☐ |
| Emerald | \$59.95 | \$49.95 ☐ |
| Sapphire | \$79.95 | \$69.96 ☐ |
| Ruby | \$89.95 | \$79.95 ☐ |

FAN FOLD COMPUTER PAPER

| | LIST | SALE |
|------------------------------|---------|------------------|
| 15# 1000 Sheets | \$14.96 | \$ 9.95 ☐ |
| 20# 1000 Sheets | \$19.95 | \$14.95 ☐ |
| 20# 1000 Sheets micro-perfed | \$19.95 | \$14.95 ☐ |
| 20# 2500 Sheets | \$32.95 | \$26.95 ☐ |



CALL TOLL FREE 800-843-6700

or call our BBS 603-357-4306 operator 1105 (N.H.—603-352-3736)

Some quantities limited. Selection may vary.

instant Software computer centers

or clip and mail coupon to Instant Software, WGE Center/70 Rte 202N, Peterborough, NH 03458
MC, VISA, M.O. or check accepted. Add \$3.00 for shipping and handling. *call for shipping charges

Name _____
Address _____
City _____ State _____ Zip _____

NEW PRODUCTS

edited by Paul Statt

Software

Facts Are Simple

Public Domain Software on File is an organized **collection of software in the public domain** for Apple II users. Twenty ready-to-boot disks with 250 programs for beginners and experts cover a range of applications from business and personal finance to speed reading, word processing, and home management. Public Domain Software on File was developed for Public Domain Research especially for libraries. All programs are menu driven and accompanied by user's guides. You can copy or modify code at will—legally. Two hundred fifty programs for \$195, from Facts on File, 460 Park Avenue, New York, NY 10016, (800) 322-8755. For more information circle number 365 on the Reader Service card.

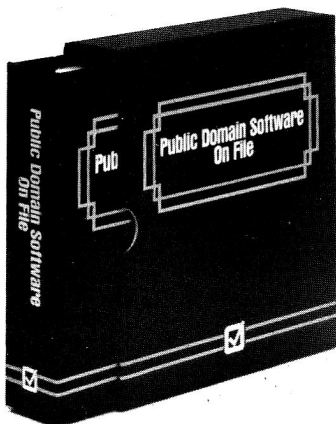

Two hundred fifty programs in Public Domain Software on File.

102



MultiScribe is a word processor with Macintosh style.

Mouse Words

MultiScribe is the first **word processor** for the Apple II series to offer all the features of the Macintosh interface, in conjunction with the double hi-res screen and proportional character spacing. MultiScribe features pull-down menus for command selection, scroll bars for moving quickly through text, and dialog boxes for extended functions and alert messages. If you don't have a mouse, you can use the "keyboard mouse," with the help of cursor-control keys and the escape key. You can choose from a variety of fonts and type sizes, or you can create your own with the font editor. What you see is what you get: Boldface, underlining, italics, outlining, shadow, subscripts, and superscripts appear on paper as they do on your display. MultiScribe sells for \$39.95, from StyleWare, 6427 Hillcroft, Suite 201, Houston, TX 77081, (713) 771-4627. For more information circle number 350 on the Reader Service card.

Screen Pass

The Video-7 Enhancer Series is a collection of **graphics and text adapters** that allow high-resolution color with your Apple II. Your Apple can now power an IBM-compatible RGB monitor. The Color Enhancer provides 16 distinct levels of color and 16 shades of gray to the //e and //c. It also lets you display readable 80-column text and 16-color graphics on the same monitor. Video-7 will include an enhanced version of Broderbund's popular Dazzle Draw with purchase of the Apple //e Color Enhancer at \$179.95, or the //c model at \$129.95. The Screen Enhancer, available for both Apple II machines, brings 16 shades of gray to the monochrome interface, 80-column text, and, for the //e, an extra 64K of internal memory. The //e version costs \$129.95, the //c \$79.95, from Video-7, 550 Sycamore Drive, Milpitas, CA 95035, (408) 943-0101. For more information circle number 353 on the Reader Service card.

Money Talks

MoneyWorks lets AppleWorks users pick from eight ready-made programs to help **plan personal finances**. You can project college expenses, real-estate purchases, stock sales, loans, life insurance, and your home budget, and decide whether to buy, rent, or lease your home or car. MoneyWorks captures the expertise of a personal banker in AppleWorks, for \$69.95, from Apropos Software, 64 Hillview Avenue, Los Altos, CA 94022, (415) 948-7227. For more information circle number 366 on the Reader Service card.

GrandMaster

Paul Whitehead Teaches Chess **teaches more than chess**: According to the publisher, the program contains the beginnings of a whole new way of representing logically related material, which will be developed in future packages. For now, champion chess master Paul Whitehead has created an expert system

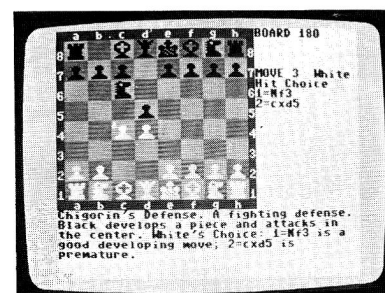

Paul Whitehead Teaches Chess—and more.

to teach rank beginners almost everything about the game. And experts can take on the Coffeehouse Chess Master, which allows them to play from any position in the tutorial. More than 40 hours of instructional material for \$49.95, from Enlightenment, 1240 Sanchez Street, San Francisco, CA 94114. For more information circle number 354 on the Reader Service card.

Another I

Alter Ego may be the last word in **simulation games**. This one lets you be anyone you want—you establish a personality by answering a number of questions about the simulated world of Alter Ego. Your answers can be truthful, or you can make them up, and you can start any time between childhood and old age. The program tracks and processes every response, to create a profile of you in your social world, as well as in emotional, physical, familial, and vocational spheres.

Alter Ego was written by Peter Favaro, a practicing child psychologist who based the game on his research with more than 300 people of all ages and backgrounds. The game is available in male and female versions for \$49.95, from Activision, 2350 Bayshore Frontage Road, Mountain View, CA 94043, (415) 960-0410. For more information circle number 351 on the Reader Service card.

inCider

Hardware

Commando

The Command Center gives you **fingertip control of up to five surge-protected power outlets**. The unit is completely EMI- and RFI-proof, and features both a locking on/off switch and an LCD clock/calendar. The Command Center is available for \$179.95 from Curtis Manufacturing Company, 305 Union Street, Peterborough, NH 03458, (603) 924-7803. For more information circle number 360 on the Reader Service card.

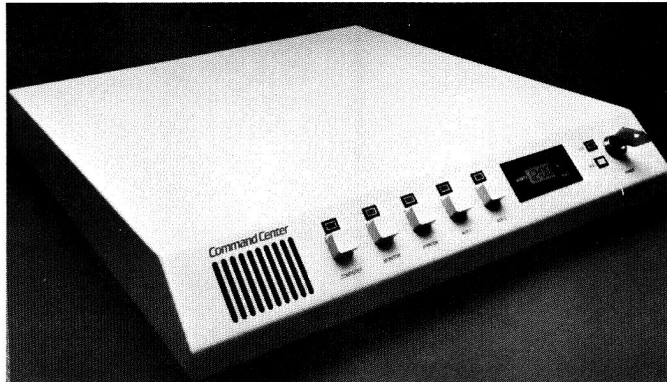

Command Center keeps your power clean.

Easy In, Easy Out

The uD-1000 I/O system **simplifies input and output** for the Apple II Plus and IIe. The board plugs into one of the Apple slots and provides eight digital outputs, eight digital inputs, and eight analog inputs. Industrial, educational, and hobby applications are easy to imagine. The uD-1000 I/O system comes with the

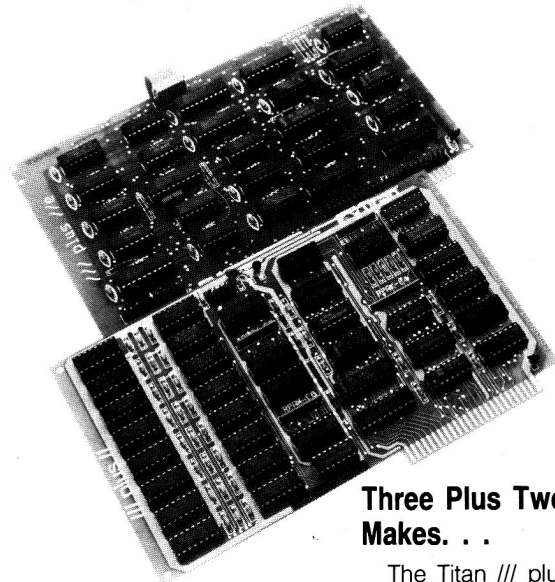

The Titan III plus IIe card runs IIe software on the Apple III.

Three Plus Two Makes. . .

The Titan III plus IIe board **emulates Apple IIe software on the Apple III**. The two-board set also adds an extra 128K of random-access memory to the Apple III. The IIe-emulation software supports both 40-column and 80-column video displays with upper- and lowercase characters. A ProDOS RAM disk in the IIe emulator uses the Apple III RAM. The software also supports a serial printer, the ProFile hard-disk drive, a double hi-res graphics display, and access from ProDOS to the Apple III clock. The board sells for \$175, from Titan Technologies, 310 West Ann Street, Ann Arbor, MI 48104, (313) 662-8542. For more information circle number 357 on the Reader Service card.

Hook, software for developers that lets you write Applesoft BASIC programs without bothering with PEEKs or POKEs. A 60-page manual is included, for \$169.95, from Micro-Dimensions, 4780 Beidler Road, Willoughby, OH 44094, (216) 946-8070. For more information circle number 355 on the Reader Service card.

Product descriptions contained in this section are based on information supplied to us by the respective manufacturers. These announcements are provided solely as a service to our readers and do not constitute endorsement by inCider of any given product.

And your Earls and Viscounts. If you've got royal ancestors, we have the noble software that can help you trace them down.

Family Roots and your Apple, IBM, Commodore, Kaypro*, and many others, offer individual and group sheets, charts, name indices, general search and text

**Put up
your
dukes!**

capabilities. Adapts to most disk drives, printers, and screens. You get more utility programs, plus lots of personal control. A comprehensive (new) manual is included.

All for just \$185.

Write or call today for more information and a free brochure.



Circle 16 on Reader Service Card.

Quinsept, Inc.

P.O. Box 216
Lexington, MA 02173
(617) 641-2930

American Express,
Visa, and MasterCard
gladly accepted.

*Trademarks for Apple
Computer Inc., International
Business Machines, CBM, Inc.
and Digital Research.

NEW PRODUCTS

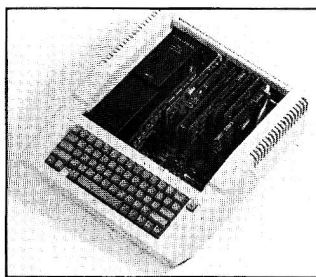

The Challenger 20-meg hard disk tucks neatly inside your II.

Hard About

Challenger provides the Apple II user with the advantage of an **internally mounted 10- or 20-megabyte hard-disk drive.**

Challenger works under a variety of operating systems, including ProDOS, DOS 3.3, CP/M, and Pascal; ProDOS volumes may be as large as 16 megabytes. The disk-drive/power-supply combination replaces the existing Apple II power supply, freeing expansion slots for other applications. Prices are \$1195 for a 10-meg Challenger, and \$1595 for the 20-meg model; contact Space Coast Systems, 301 South Washington Avenue, P.O. Drawer 2767, Titusville, FL 32781-2767, (305) 268-0872, or circle number 361 on the Reader Service card.

More Megs

RamWorks II now comes with **3 megabytes of on-board RAM**, thanks to an add-on piggyback card. A 64K printer buffer is included on the RamWorks II card. The 3-megabyte RamWorks II package sells for \$1699; RamWorks II with 1 megabyte of RAM is \$389. Contact Applied Engineering, P.O. Box 798, Carrollton, TX 75006, or circle number 362 on the Reader Service card.

Star Storage

The MicroStor family of **hard-disk/tape-backup units** has a new member—a 20-megabyte subsystem for the IIe running under ProDOS, DOS 3.3, Pascal, or CP/M. MicroStor is available for \$1995 from AST Research, 2121 Alton Avenue, Irvine, CA 92714. Circle number 364 on the Reader Service card.

Color RAM

The MultiRam RGB is a **multifunction interface card** that provides RGB color output and up to 400 megabytes of random-access memory. The MultiRam RGB card fits into the auxiliary slot on the Apple II motherboard, to replace the standard 64K 80-column card. You'll have all that the Apple 80-column card offers and a megabyte of memory, too. The card can be expanded to as much as 4 megabytes, and accepts the optional Western Design Center 65C816 16-bit coprocessor, as well. It works with ProDOS, DOS 3.3, and Apple Pascal operating systems, for less than \$200, from Checkmate Technology, 509 South Rockford Drive, Tempe, AZ 85281, (602) 966-5902. For more information circle number 356 on the Reader Service card.

Cheap Joy

The Suncom Tac-10 is a low-cost **Apple II-compatible analog joystick controller.** The one-handle top and two case-mounted action buttons provide great flexibility for cursor control. Dual cursor-centering trimmers allow precise x- and y-axis adjustment. The Tac-10 works with the IBM PC and Franklin Ace computers, too. The price is a mere \$34.95, from Suncom, 260 Holbrook Drive, Wheeling, IL 60090, (312) 459-8000. For more information circle number 352 on the Reader Service card.

THE BASEBALL DATABASE



**LET YOUR COMPUTER
KEEP TRACK OF YOUR
TEAM'S BASEBALL STATS
FOR YOU!**

EASY TO USE

- Clear Screen Directions
- Easy Data Entry and Correction
- Detailed Users Manual
- Fast Statistics Retrieval from Disk

COMPREHENSIVE

- 23 Batting and Fielding Statistics
- 22 Pitching Statistics
- Up to 30 Players
- Unlimited Games
- Hits, Runs, Errors, LOB and ERs for Every Inning
- All Totals, Cumulatives, Averages Etc. Calculated

DETAILED PRINTED REPORTS

- Player Rosters
- Game Summaries
- Pitching Cumulatives
- And a lot more
- Win/Loss Records
- Team Cumulatives
- Player Histories

\$49.95 APPLE IIe/IIc **\$39.95** COMMODORE 64

• 15 day money back guarantee

- Check or money order please, plus \$2.50 shipping and handling
- Program specs and details available upon request.

JACOBSEN SOFTWARE DESIGNS

1590 E. 43rd Avenue
Eugene, Oregon 97405
Phone: (503) 343-8030

Product Updates

● Tom Weishaar and Bert Kersey were two of the most popular and talented writers at *Softalk* magazine—now their best DOS-Talk columns have been collected into **The DOS-Talk Scrapbook** (paper, \$14.95, Tab Books). Fans should also take a look at Weishaar's **Open-Apple** newsletter (\$24 per year, P.O. Box 7651, Overland Park, KS 66027).

● If Pinpoint's Desktop Accessories aren't exactly what you wanted, design your own with the **Pinpoint Toolkit** (\$49.95). Also available is the **Pinpoint Spelling Checker**, for only \$49. But the best is the **RAM Enhancement Kit** that lets you load your applications into RAM and quickly point and shoot between them with a RAM Switcher. Only \$9 from Pinpoint, 5901 Christie, Emeryville, CA 94608, (415) 654-3050.

● Infocom's latest, **Ballyhoo**, has you hanging around the big top, solving a circus mystery by unravelling riddles. Fascinating people and places, for \$39.95 from Infocom, 124 Cambridge Park Drive, Cambridge, MA 02140, (617) 492-6000.

● At the AppleWorld Expo in January, Borland demonstrated **Turbo Modula-2** on an Apple IIe running CP/M with a Z-80 coprocessor card. Will ship this summer, says Borland, 4585 Scotts Valley Drive, Scotts Valley, CA 95066, (408) 438-8400.

● At the Computer Chess Championships last fall in Denver, Colorado, David Levy and Intelligent Software (England) placed third—to mainframe super "chess machines"—with an Apple IIe. Enhancements? A mere **Accelerator IIe**, \$139, from Titan Technologies, 310 West Ann Street, Ann Arbor, MI 48104, (313) 662-8542.

● The people's choice in early education, **Elfware**, is now faster and more responsive. Still an amazing \$39.95 for three programs, from Elfware, P.O. Box 118, Pollock Pines, CA 95726, (916) 644-3300.

● At Winter CES, Mindscape showed us **The Luscher Profile**, which analyzed us in color with accuracy; **The American Challenge: A Sailing Simulation**, which may train nautical neophytes to keep the America's Cup in the proper hemisphere; and promised simulations of a **Dick Francis** mystery novel and a **James Bond** adventure (all \$39.95). A creative company to watch, at 3444 Dundee Road, Northbrook, IL 60062, (312) 480-7667.

● More creative endeavors: Lord British and Electronic Arts have finally released **AutoDuel**, a meld of the movie *Road Warrior* and the runaway Ultima games. "A scary view of a ravaged future in which only the most cunning automotive warriors survive": this month's best press release. \$49.95 from Electronic Arts, 2755 Campus Drive, San Mateo, CA 94403, (415) 571-7171.

● Advanced Logic Systems has bundled three programs—**Word Handler**, **List Handler**, and **Spell Handler**—into an attractive \$99.95 package for word and list processing and spelling checking. 1195 East Arques Avenue, Sunnyvale, CA 94086, (408) 730-0307.

● The **Laser 128** is a IIc lookalike and IIe workalike with built-in disk drive, numerical keypad, function keys, modem and printer interfaces, and expansion slot—all for \$395. Check that price with Central Point Software, 9700 Southwest Capitol Highway, Portland, OR 97219, (503) 244-5782.

APPLE II DATA ACQUISITION DISPLAY & PLOTTING SOFTWARE

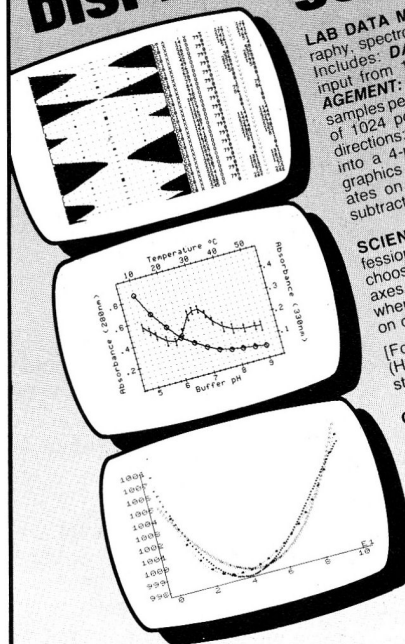

LAB DATA MANAGER software for chromatography, spectroscopy and many other applications. Includes: **DATA ACQUISITION**: samples A/D input from 1 to 16 channels; **MEMORY MANAGEMENT**: extra RAM cards can store up to 32K samples per channel; **FAST DISPLAY**: 4 data sets of 1024 points with zoom and scrolling in 4 directions; **STRIPCHARTS**: turns your printer into a 4-pen chart recorder that prints both graphics and text; **DATA PROCESSING**: operates on large data sets, e.g., differentiate, subtract baseline, integrate peaks. . . . \$250

SCIENTIFIC PLOTTER — Draws professional-looking graphs of your data. You choose data format, length and position of axes, 20 symbols, error bars, labels anywhere in 4 orientations. Includes 5 demos on disk plus 30-page manual. . . . \$25
[For DIF file or plotter adaptations (Hewlett-Packard, Apple, Houston instrument) add \$25 for each option.]

CURVE FITTER — Select the best curve to fit your data. Scale, transform, average, smooth, interpolate (3 types), LEAST SQUARES fit (3 types). Evaluate unknowns from fitted curve. Includes 5 demos on disk with 33-page manual. . . . \$35

ORDERING INFO — Add \$2.50 shipping on all U.S. orders. VISA or MASTERCARD orders accepted.
*Trademark of Apple Computer, Inc.

Write, call or Telex
for our latest catalog!



INTERACTIVE MICROWARE, INC.

P.O. Box 139, Dept. 52, State College, PA 16804
Phone: (814) 238-8294 • Telex: 705250

Circle 12 on Reader Service Card.

APPLE(II+)WORKS PLUS-WORKS™

It Really Works!!

PLUS-WORKS not only allows you to have all features of AppleWorks™ on an Apple II™, II+ or compatible, but our extended memory versions give you capabilities far beyond the standard IIe/c versions. Its great for expansion on the Apple IIe as well.

Compare these features with other AppleWorks patch programs

- Copyable - make backups, transfer to hard disk
- Up to 1 megabyte of **desktop** space available
- Database expansion to more than 4,200 records
- All control codes available to printer
- Supports Franklin computers and all full ASCII keyboards
- Supports all major 80 column cards
- Permanent and dynamic ram disk features
- All versions of AppleWorks supported, even V1.3
- Expand AppleWorks desktop into CP/M ram cards
- Optional patch to help with printer problems

• **PLUS-WORKS** - \$19.95 plus \$3.00 ship/hand. Requires AppleWorks, 64K Apple II+ or compat, 80 col card and shift key mod. Maximum desktop 10K. You may upgrade to XM for \$30.00 at any time.

• **PLUS-WORKS-XM** - \$49.95 plus \$3.00 ship/hand. Requires same as above with legend, saturn, or compatible ram card (A.P.P.L.E. Big board, know Drive, prometheus, etc), Apple Computer's memory expansion card, Microtek ram card, Orbital disco-ram, PCPI Applicard, Micropro Star card, IBS AP33 ram card, or Apple IIe with ramcard.

• **PLUS-WORKS-L** - Special version for Laser 3000, 10K desktop - \$19.95 plus \$3.00 ship/hand.

• **PLUS-WORKS-XMB** - Special version for Basis 108, \$49.95 plus \$3.00 ship/hand

• **Special combination offer - PLUS-WORKS-XM & 256K Apple Memory expansion card (expandable to 1 megabyte) - \$295.00**

MC/Visa add 4%

Information, Alaska & New Jersey residents call 516-922-9584
or send check or money order to:

Orders only 1-800-221-3826

Norwich Data Services

PO Box 356

East Norwich, NY 11732-0356

NYS residents add appropriate sales tax

Dealer inquiries invited

Apple & AppleWorks are trademarks of Apple Computer Inc.
PLUS-WORKS is a trademark of Norwich Data Services Ltd.

HINTS/TECHNIQUES

Super Startup

by Scott R. Bowers

Good old DOS 3.3 was easy to use—directories, prefixes, and so on were pretty simple. Then Apple introduced ProDOS. It was much faster and more advanced than DOS—but it's more complicated and harder to use, too.

Before ProDOS, I installed my faithful hello program on every DOS 3.3 disk I owned. The program was short and made it easy to do a variety of disk operations with just one or two key presses. I knew that was just what my new ProDOS disks needed. But after attempting to convert my old hello program to ProDOS, I soon realized I'd have to write another program to make full use of the features of Apple's new operating system. I came up with Super Startup.

Startup Operation

Super Startup is short, no-nonsense, and easy to use. After booting up your ProDOS disk with Startup installed, the first thing you see is a 40-column catalog of the disk on screen. Just as with ProDOS, you can pause the catalog with control-S or stop it with control-C. The program then successively labels all the files listed, beginning with the letter A. All subdirectories are labeled with inverse characters.

Below the catalog is a message scrolling the options available: TYPE LETTER TO RUN, OR LOAD=1 LOCK=2 UNLOCK=3 DELETE=4 CHANGE DRIVES=5 EXIT=6. You can also press the appropriate letter key to catalog a subdirectory, the backspace key to move back one directory level, or the escape key to recatalog the volume directory of any disk in the current drive. (Startup even accepts lowercase.)

If you choose any of options 1 through 4, Startup prompts you to press the letter key corresponding to the file on which you want to perform

the operation. If you change drives, Startup prompts you for the new slot and drive numbers. The exit option leaves you in the current prefix with a BASIC prompt at the bottom of the screen.

Line by Line

To use Super Startup, first type in the Applesoft program shown in the accompanying **Program listing** and save it to disk with the command **SAVE STARTUP**.

The heart of the program lies in the formula in line 480:

$$ME = 769 + (P * 128) + (KK * 128) - (769 + (P * 128) + (KK * 128) > 1921) * 948 - (769 + (P * 128) + (KK * 128) > 2945) * 984$$

Variable ME is the starting memory location on the text screen where the file name is located. Variable P is the line number of the first file; KK is the line number from P of the file on which you want to operate.

I found that the fastest way to designate a string variable equal to a file name is to read the names of the files directly from the 40-column text screen letter by letter with this formula.

Program listing. Super Startup for your ProDOS disks.

```
10 ONERR GOTO 530
20 DIM ID(26),ID$(25),I$(25)
30 D$ = CHR$(4): TEXT : PRINT CHR$(27) + CHR$(17): POKE 33,40:
PRINT D$;"PREFIX/": PRINT D$;"PREFIX": INPUT I$(0)
40 MS$ = "TYPE LETTER TO RUN, OR LOAD=1 LOCK=2 UNLOCK=3 DELETE=4
CHANGE DRIVE=5 EXIT=6...."
50 SN = 6:DN = 1
60 HOME :DI$ = "":DD = 0:BE = 1041:S = 913:P = 0:L = 64:K = 0:AA =
0:CC = 1: IF SD = 1 THEN PRINT D$;"CAT,S";SN;"D";DN:CC = 0
70 IF SD = 1 THEN 100
80 PRINT D$;"CAT":CC = 0
90 IF LE > 0 THEN 110
100 VTAB 23: PRINT D$;"PREFIX": INPUT I$(0):SD = 0:CC = 0
110 S = S + 128:P = P + 1: IF PEEK(S) = 217 OR PEEK(S) = 160 THEN
110
120 FOR I = BE TO BE + 80 STEP 40: FOR J = I TO I + 896 STEP 128:K =
K + 1:ID(K) = PEEK(J) + PEEK(J + 1): IF ID(K) = 320 AND K > P AND
AA = 0 THEN LP = K - 1:AA = 1
130 NEXT J: NEXT I
140 IF P = 9 THEN LP = 5: GOTO 170
150 FOR I = P TO LP: VTAB I: HTAB 18:L = L + 1: PRINT "["; CHR$(
L);"]": IF ID(I) = 397 THEN VTAB(I): HTAB 19: INVERSE : PRINT CHR$(
L): NORMAL
160 NEXT I
170 VTAB LP + 2: HTAB 1: PRINT LEFT$(MS$,39);MS$ = MID$(MS$,2) +
LEFT$(MS$,1):KK = PEEK(-16384): IF KK < 128 THEN FOR LL = 1 TO
75: NEXT LL:: GOTO 170
180 IF KK > 224 THEN KK = KK - 32
190 POKE -16368,0:KK = KK - 192: IF P = 9 AND KK < > - 37 AND KK
< > - 56 AND KK < > - 11 AND KK < > - 10 THEN 170
200 IF KK = - 37 THEN PRINT D$;"PREFIX/":LE = 0: GOTO 60
210 IF LE > 0 THEN IF KK = - 56 THEN LE = LE - 1:FF$ = "": FOR FF =
0 TO LE:FF$ = FF$ + I$(FF): NEXT FF: PRINT D$;"PREFIX";FF$: GOTO 60
220 IF (KK < - 15 OR KK > - 10) AND (KK < 1 OR KK > 1 + LP - P)
THEN 170
230 IF KK < - 9 THEN 290
240 GOSUB 480:II = ID(P - 1 + KK)
250 IF II = 397 THEN PRINT D$;"PREFIX";DI$:LE = LE + 1:I$(LE) = DI$
+ "/": GOTO 60
260 IF II = 395 THEN B$ = "B"
270 IF II = 387 OR II = 395 THEN OP$ = "RUN": GOSUB 520: END
280 IF II < > 397 OR II < > 395 THEN OP$ = "-": GOSUB 520: END
290 IF KK = - 15 THEN OP$ = "LOAD"
```

Listing continued.

You can modify the formula slightly to convert HTAB and VTAB coordinates to their memory locations. Knowing which memory addresses correspond to text-screen coordinates is helpful whenever you need to read characters on the text screen. You can convert the vertical line number if P is set equal to one and KK is equal to the vertical line number to be converted. Add the horizontal column number minus one to the result to find the final location.

Lines 10 through 100 set up beginning variables, record the prefix of the current disk, and print the disk catalog. Line 110 finds the line number of the first file and assigns it to the variable P.

The next line sets up an array that holds the file types of all the files on screen. It also finds the line number of the last file on screen and assigns it to the variable LP. To determine file types, I read the first two letters of the abbreviations under the TYPE column in the catalog.

Lines 150 and 160 label the files. Line 170 then scrolls the option message while waiting for a key press. All disk operations from here on are accomplished through the subroutine in line 520. In that line, the variable B\$ is set either to B or to nothing, depending on whether the file is binary or not. OP\$ is the variable that contains the disk command; DI\$ contains the name of the file on which you want to operate.

Lines 210 and 250 keep track of subdirectory levels, with variable LE as the pointer containing the current level, and array I\$(LE) as the names of the directory prefixes.

The rest of Super Startup sorts out key presses and controls disk operations performed on the files.

One reason I first hesitated to change over from DOS 3.3 to ProDOS was the lack of a hello program that would let me run programs easily without much typing. I hope Super Startup encourages you to make the switch to ProDOS. It's powerful, fast—and now it's easy. ■

Write to Scott Bowers at Route 5, Box 1338, College Station, TX 77840.

Got a hint of your own? inCider would like to see it. If we can use it in Hints/Techniques, we'll buy it from you. Send your tip to: inCider, 80 Pine Street, Peterborough, NH 03458.

Listing continued.

```

300 IF KK = - 14 THEN OP$ = "LOCK"
310 IF KK = - 13 THEN OP$ = "UNLOCK"
320 IF KK = - 12 THEN OP$ = "DELETE"
330 IF KK = - 10 THEN VTAB 23: END
340 IF KK = - 11 THEN VTAB LP + 2: HTAB 1: PRINT "SLOT:
": VTAB LP + 2: HTAB 7: GET SN$: POKE - 16368,0
350 IF KK = - 11 THEN : HTAB 1: PRINT "DRIVE: ";: GET DN$: IF ASC
(SN$) < 49 OR ASC (SN$) > 55 OR ASC (DN$) < 49 OR ASC (DN$) > 50
THEN 170
360 IF KK = - 11 THEN SN = VAL (SN$):DN = VAL (DN$): PRINT
D$;"PREFIX/":SD = 1:LE = 1: GOTO 60
370 VTAB LP + 2: HTAB 1: PRINT "TYPE 'LETTER' YOU WISH TO ";OP$;"
": POKE - 16368,0: REM 9 SPACES
380 KK = PEEK ( - 16384): IF KK < 128 THEN 380
390 IF KK > 224 THEN KK = KK - 32
400 IF OP$ = "LOAD" THEN 410
410 POKE - 16368,0:KK = KK - 192: IF KK < 1 OR KK > 1 + LP - P THEN
170
420 GOSUB 480
430 IF OP$ = "LOAD" THEN 450
440 GOSUB 520: GOTO 60
450 II = ID(P - 1 + KK): IF II = 428 OR II = 397 THEN VTAB LP + 2:DI$
= "": GOTO 170
460 IF II = 395 THEN B$ = "B"
470 GOSUB 520: GOTO 60
480 LO = 769 + (P * 128) + (KK * 128):ME = LO - (LO > 1921) * 984 -
(LO > 2945) * 984
490 SM = ME - 1:DI$ = ""
500 SM = SM + 1:DD = DD + 1:DI$ = DI$ + CHR$ ( PEEK (SM) - 128): IF
PEEK (SM) < > 160 THEN 500
510 DI$ = LEFT$( DI$,DD - 1): RETURN
520 HTAB 1: VTAB LP + 2: POKE - 16368,0: PRINT B$:OP$;" ";DI$;"
":: PRINT D$:B$:OP$:DI$:B$ = "": RETURN : REM 33 SPACES
530 IF PEEK (222) = 255 AND CC = 1 THEN 100
540 IF PEEK (222) = 255 THEN VTAB 23: PRINT CHR$ (7): END
550 IF PEEK (222) = 3 THEN SN = 6:DN = 1: GOTO 60
560 IF PEEK (222) = 10 THEN FL = 1: HTAB 1: VTAB LP + 2: PRINT "FILE
LOCKED. CONTINUE? (Y/N)"
570 IF FL = 1 THEN Q = PEEK ( - 16384): IF Q < > 217 AND Q < > 249
AND Q < > 206 AND Q < > 238 AND Q < > 141 AND Q < > 155 THEN 570
580 POKE - 16368,0
590 IF FL = 1 AND (Q = 217 OR Q = 249) THEN OP$ = "UNLOCK": GOSUB
520:OP$ = "DELETE": GOSUB 520:FL = 0: GOTO 60
600 IF FL = 1 AND (Q = 206 OR Q = 238 OR Q = 141 OR Q = 155) THEN FL
= 0: GOTO 170
610 IF PEEK (222) > 0 THEN VTAB 23: HTAB 1: PRINT "ERR NUMBER=";
PEEK (222);" IN LINE "; PEEK (218) + PEEK (219) * 256: PRINT CHR$
(4);"PREFIX/": POKE - 16368,0: END

```

End of listing.



5 1/4" DS/DD with hub ring and sleeve, factory warranted, packaged in 50's. Shipping Extra. Quantity 50, 85¢ each.

The same low price our volume copying customers pay!

75¢

each Qty. 100

We sell 3 1/2" & 5 1/4" disks—all types, major brands. Call toll free:

1-800-321-4668

in Colorado, 303-234-0871

VISA, MASTERCARD, OR COD ACCEPTED

ALF 1315-F Nelson St. Denver, CO 80215

P-tral:

BASIC to Pascal Translation Software

P-tral is the user-friendly translation software that converts AppleSoft BASIC programs to Apple Pascal.

- Translates any business, scientific, graphics and game software from source.
- Translation results approach 100%.
- Translates any sized program—Large or Small.
- Essential compile directives generated.
- Version 1.0 \$179.00.

REQUIREMENTS: 64/128K RAM, Dos 3.3 80-column card/Apple II, IIe, IIc Apple Pascal 1.1 or 1.2

To order or request more information contact: **WOODCHUCK INDUSTRIES**
340 West 17th Street, New York, NY 10011
(212) 924-0576 / (212) 206-6490

NEW!

The Diversified Accountant™ Job Cost System

The Best By Far - The Diversified Accountant is by far the fastest, most powerful, and easiest to use Job Cost System on the market.

High Capacity - Handles 1,000 active jobs, 200 work codes, and 845 vendors or employees. Holds 380,000 data entries on a 10-meg hard disk, or 3,000 entries on a floppy disk.

Optimized Data Entry - Accepts data as fast as you can type. Skilled operators can enter a complete transaction in less than 10 seconds.

Highly Flexible Reports - Unique data selection/computation process lets you find virtually anything you want to know about your actual and estimated costs.

Incredibly Fast - Using Pascal and optimized Machine Language, The Diversified Accountant can usually compute a report faster than your printer can print it.

Programmer Supported - Mail and telephone support is available from Bill Basham. We will notify you of all major updates, which you can buy for \$5.

Try it First - Our \$5 demo disk is an actual working copy of the program. We believe that the best way to sell a program this good, is to put it in your hands. Check it out!

BUY THE BEST BY FAR BUY DSR

- Diversi-DOS™** \$30
DOS 3.3 enhancement
- Diversi-COPY™** \$30
Hi-speed disk back-up/format
- Diversified Accountant™** \$475
Job Cost System
- Demonstration Disk \$5
- Diversi-DIAL™** \$475
7-line C.B.-simulator
- Demonstration Disk \$5

24-Hour Toll-Free Ordering

800 835-2246 ext. 127 (orders only)

For information call 313 553-9460

300-Baud Modem call 313 553-4466

FREE: Dogfight II arcade game included with Diversi-DOS and Diversi-COPY

All programs work on Apple //e, //c or 64K Apple II+ compatible computers.

Sold by Mail-Order Only. Price includes 1st class or foreign airmail.

C.O.D., Visa/Mastercard (Include Exp. Date)
Personal Check, Purchase Orders accepted

Diversified Software Research, Inc.
34880 Bunker Hill
Farmington, MI 48018-2728 

COMING ATTRACTIONS

- **Telecommunicating:** *inCider* looks at what's on line and how to get started with your modem.
- **Feature review:** Bill O'Brien evaluates high-speed and standard modems.
- **Special hardware project:** Build your own modem for less than \$30.
- **Looking for a self-help project?** Our review will help you find the right software for everything from cooking to fitness to psychology.
- **See how schools are sharing information with the community via their BBSs** (bulletin-board systems).
- **Reviews:** Viewtron, Genie, Managing Your Money, and more

MOVING? PROBLEM?

Get help with your subscription by calling our new toll free number:

1-800-645-9559*

between 9 a.m. and 5 p.m. EST,
Monday-Friday.

If possible, please have your mailing label in front of you as well as your cancelled check or credit card statement if you are having problems with payment.

If moving, please give both your old and new address.

*New York State residents call
1-800-732-9119.

inCider

inCider magazine is published monthly by CW Communications/Peterborough, Inc. Entire contents copyright 1986 CW Communications/Peterborough, Inc. No part of this publication may be reprinted, or reproduced by any means, without prior written permission from the publisher. All programs are published for personal use only. All rights reserved.

inCider is a member of the CW Communications/Inc. group, the world's largest publisher of computer-related information. The group publishes over 50 computer publications in more than 20 major countries. Nine million people read one or more of the group's publications each month. Members of the group include: ARGENTINA'S *Computerworld/Argentina*; ASIA'S *Asian Computerworld*; AUSTRALIA'S *Computerworld Australia*, *Australian PC World*, and *Macworld*; BRAZIL'S *DataNews* and *PC Mundo*; CHINA'S *China Computerworld* and *China Computerworld Monthly*; DENMARK'S *Computerworld/Danmark*, *PC World*, and *Run (Commodore)*; FINLAND'S *Mikro*; FRANCE'S *Le Monde Informatique*, *Golden (Apple)*, *OPC (IBM)*, *Theoreme*, and *Distributive*; GERMANY'S *Computerwoche*, *Infowelt*, *PC Welt*, *Computer Business*, and *Run*; ITALY'S *Computerworld Italia* and *PC Magazine*; JAPAN'S *Computerworld Japan*; MEXICO'S *Computerworld/Mexico*; THE NETHERLANDS' *Computerworld Netherlands* and *PC World*; NORWAY'S *Computerworld Norge* and *PC Mikrodata*; SPAIN'S *Computerworld Espana*, *PC World*, and *Commodore World*; SWEDEN'S *ComputerSweden*, *Mikrodatorn*, and *Svenska PC World*; SWITZERLAND'S *Computerworld Schweiz*; THE UNITED KINGDOM'S *Computer News*, *PC Business World*, and *Computer Business*; VENEZUELA'S *Computerworld Venezuela*; THE U.S.'S *AmigaWorld*, *Computerworld*, *inCider*, *InfoWorld*, *MacWorld*, *Micro Marketworld*, *PC World*, *Run*, *80 Micro*, *Focus Publications*, and *On Communications*.

Problems with Advertisers: Send a description of the problem and your current address to *inCider*, Route 101 and Elm Street, Peterborough, NH 03458, attn. Rita Rivard, Customer Service Manager. If urgent, call (800) 441-4403.

Problems with Subscriptions: Send a description of the problem and your current and/or most recent address to: *inCider*, Subscription Department, P.O. Box 911, Farmingdale, NY 11737. Or call (800) 645-9559, (800) 732-9119 in New York, between 9 a.m. and 5 p.m. E.S.T., Monday through Friday. If you have a problem with payment, please have your mailing label and your cancelled check or credit card statement in front of you.

Change of Address: Send an old label or a copy of your old address and new address to: *inCider*, P.O. Box 911, Farmingdale, NY 11737. Please give eight weeks' advance notice.

Microfilm: This publication is available in microform from University Microfilms International. United States address: 300 North Zeeb Road, Dept. P.R., Ann Arbor, MI 48106. Foreign address: 18 Bedford Row, Dept. P.R., London, WC1R4EJ, England.

Dealers: Contact Raino Wirein, Direct and Newsstand Sales Manager, *inCider*, Route 101 and Elm Street, Peterborough, NH 03458. Call (800) 343-0728.

Back Issues: Send \$3.50, plus \$1.00 postage for each copy to *inCider*, Back Issues Dept., Route 101 and Elm Street, Peterborough, NH 03458. For ten or more copies postage is a blanket \$7.50. To order by telephone using VISA, MasterCard or American Express call (800) 258-5473 from outside New Hampshire, or 924-9471, ext. 136, within New Hampshire.

Submissions: We're always looking for first-class manuscripts at *inCider*. We'll consider publication of any material for the Apple. Guidelines for budding authors are available—just address an envelope to yourself and include it with your request. Mail manuscripts, queries, or requests for writers' guides to: *inCider* Editorial Offices, 80 Pine Street, Peterborough, NH 03458.

Flight Simulator II

For Apple II+,
Apple IIe, & Apple IIc

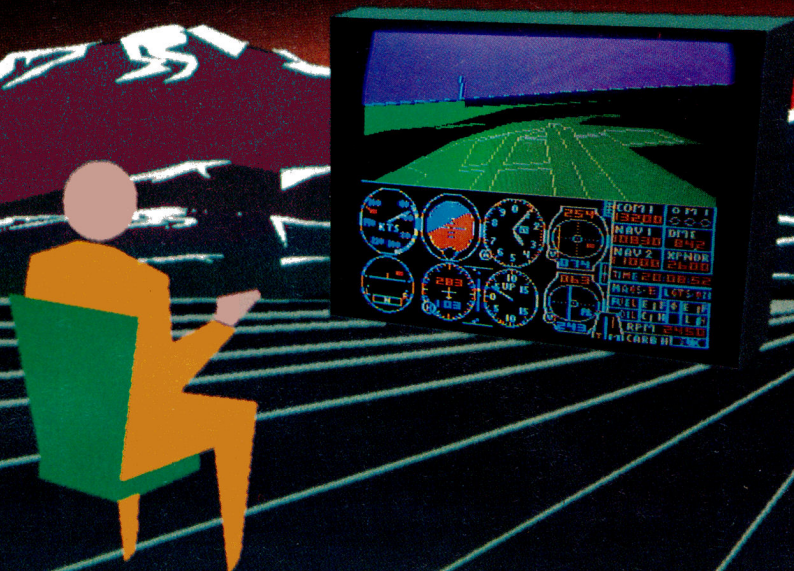

Put yourself in the pilot's seat of a Piper 181 Cherokee Archer for an awe-inspiring flight over realistic scenery from New York to Los Angeles. High speed color-filled 3D graphics will give you a beautiful panoramic view as you practice takeoffs, landings, and aerobatics. Complete documentation will get you airborne quickly even if you've never flown before. When you think you're ready, you can play the World War I Ace aerial battle game. Flight Simulator II features include ■ animated color 3D graphics ■ day, dusk, and night flying modes ■ over 80 airports in four scenery areas: New York, Chicago, Los Angeles, Seattle, with additional scenery areas available ■ user-variable weather, from clear blue skies to grey cloudy conditions ■ complete flight instrumentation ■ VOR, ILS, ADF, and DME radio equipped ■ navigation facilities and course plotting ■ World War I Ace aerial battle game ■ complete information manual and flight handbook.

See your dealer . . .

or write or call for more information. For direct orders enclose \$49.95 plus \$2.00 for shipping and specify UPS or first class mail delivery. American Express, Diner's Club, MasterCard, and Visa accepted.

Order Line: 800 / 637-4983

Circle 156 on Reader Service Card.

subLOGIC
Corporation
713 Edgebrook Drive
Champaign IL 61820
(217) 359-8482 Telex: 206995

CALL TOLL FREE 1-800-382-2242

NEAR THE SOFTWARE WE WILL BEAT

88 Ryders Lane, Stratford, Connecticut 06497 (See Below)

1. Top our unmatched selection and inventory of software/hardware for the Apple, Mac (as well as the IBM PC, and Commodore Amiga).
2. School and corporate purchase orders are welcomed. CALL 1-800-874-1108.
3. Special/rush orders. If something you need is not listed, hard to find, or needed in a hurry, CALL 1-800-874-1108.
4. Order Status. CALL (203) 375-3860.
5. FREQUENT PURCHASER PROGRAM. Effective 10/14/85, any repeat customer who has placed an order after 9/4/85 will automatically receive \$1 off any order he or she places with us. Please mention to your operator that you are a repeat customer. We value your continuing business. Send in \$1,000 worth of invoices (representing previous purchases) and you will receive a coupon worth 1% off any future purchase. With \$5,000 worth of invoices, receive a coupon worth 5% off any future purchase.
6. SOFTWARE RENTAL LIBRARY. For 25% of our price, rent any program for two weeks. Apply your rental fee toward purchase if you choose.
7. No additional charges for credit card orders.
8. Convenient hours. 7 days/week: 9 AM-11 PM EST.
9. Technical experts on duty.
10. FREE AIR EXPRESS SHIPPING. Purchase \$150 or more of software and for no additional charge we will ship your products by air courier. Mention this to your operator as you place your order.
11. FURTHER DISCOUNTS BY MAIL. Circle the items in our ad you want, send the ad in with the coupon below and receive \$.50 off each item! Cut out a competitor's ad with a lower price and we will give you \$1 off his price (subject to the conditions below).

Send coupon and list of items desired to DISCOUNT BY MAIL DEPARTMENT
Northeastern Software, 88 Ryders Lane, Stratford, CT 06497

To be eligible for the \$.50 per item discount you must:
1. Fill out all items. 2. Send in our ad with the items you desire circled.

Name _____
Address _____
City _____ State _____ Zip _____
Phone No. at above address _____

Check form of payment
 Visa MasterCard C.O.D. Personal Check
 Certified Check Money Order

Card No. _____ Exp. Date _____ 85

Personal and company checks allow 3 weeks to clear. For faster delivery, send cashier's check, certified check, or money order. Shipping—Software (\$3.00 minimum). Shipping—Hardware (please call 203-375-3860). COD—Add an additional \$2.00. Alaska, Hawaii, Canada, PD, APD, and FPO \$3.00 minimum. Foreign orders—\$15.00 minimum and 15% of all orders over \$100. Mastercard and Visa (please include card no. and expiration date). Connecticut residents add 7.5% sales tax. Prices subject to change without notice. All returns must have a return authorization number. Call 203-375-3860 to obtain one before returning goods for replacement. Defective merchandise replaced with same item only. We do not guarantee compatibility. All sales are final. *Comparable advertised price* does not include typographical errors on the part of other vendors or prices that do not reflect higher shipping costs, credit card charges, or membership fees. The \$1 off offer only applies to items where Northeastern's price is not already the lowest. Final judgement remains with the manager on duty.

| SPECIALS | | COPY PROGRAMS AND BOARDS | | ENTERTAINMENT | | PRINTER INTERFACES | | ACCESSORIES/TURBO BOARDS | |
|-----------------------|--------|-------------------------------|-------|------------------------------------|--------|---------------------------------|--------|-----------------------------------|-------|
| Ultima 4 | 33.00 | Back It Up III | 42.00 | ACCOLADE | 20.00 | ORANGE MICRO | 131.50 | Science Island or Treasure Hunter | 23.25 |
| Silent Service | 19.50 | CIA Files | 46.75 | Beachhead | 19.00 | Buffered Groppler | 72.00 | Easy Graph or Friendly File | 23.25 |
| Appleworks | 174.00 | Copy II+ | 19.00 | Beachhead II | 19.00 | Grappler Plus | 72.00 | Educac | 23.25 |
| Spellworks | 37.00 | Copy Master II 128k w/6C Dump | 93.00 | Dave Busters | 20.25 | SPICES LABS | 34.75 | HAYDEN | 12.00 |
| Javes | 35.00 | EDD III | 43.50 | Fight Night | 18.25 | Nice Print | 104.75 | Word Challenges | 12.00 |
| Mozibus | 35.00 | Lordsmith 6.0 | 64.00 | Hardball | 20.50 | TEXTPRINT | 123.50 | Rocky's Boots or Robot Odyssey | 27.75 |
| R. Wagner House Write | 72.00 | Middles Away III | 58.00 | Low of the West | 19.50 | Printer II (Parallel or Serial) | 87.50 | Number Shunter or Boolean Reboot | 22.75 |
| Super Serial Card | 104.00 | Wildcard II | 70.00 | PSI 85 Trading Post | 19.50 | THIRDWARE | 87.50 | Magic Spells or Word Spinners | 29.50 |
| Pinpoint | CALL | | | Sundog | 22.50 | FingerPrint Plus | 87.50 | Bumble Games or Burnable Plot | 23.25 |
| Reportworks | CALL | | | ACTIVISION | 22.50 | | | Centaur's Puzzle or Secrets | 24.75 |
| | | | | Borrowed Time | 22.50 | | | MAGNUM | 32.25 |
| | | | | Countdown to Shutdown | 22.50 | | | Super Speed Reading | 30.00 |
| | | | | Ghostbusters or Zani | 23.00 | | | MECC | |
| | | | | Kind Shadow or Space Shuttle | 23.00 | | | Elementary Series (EACH) | 29.00 |
| | | | | The Trozer Sanction or H.E.R.O. | 23.50 | | | Math or Health Series (EACH) | 29.00 |
| | | | | AVAILON HILL | | | | MICROSOFT | 14.75 |
| | | | | Under Fire | 32.00 | | | Typing Tutor II | 14.75 |
| | | | | AWANT GUARD | | | | CALL | |
| | | | | Dave Winfields Better Up | 22.50 | | | Math Sequences (EACH) | 20.25 |
| | | | | BLUE CHIP | 23.25 | | | Number Chase or Pop R' Spell | 23.50 |
| | | | | Millionaire, Baron or Tycoon | 23.25 | | | RAMSON Word Processor | 41.50 |
| | | | | Secure | 25.00 | | | MINDSCAPE | 41.50 |
| | | | | BRODERBUND | 20.00 | | | Perfect Score SAT | 41.50 |
| | | | | Captain Goodnight | 20.00 | | | | |
| | | | | Championship Lode Runner | 19.85 | | | | |
| | | | | Choplifter | 19.85 | | | | |
| | | | | Lode Runner or Xerataka | 19.85 | | | | |
| | | | | Mask of the Sun | 22.25 | | | | |
| | | | | Where... Is Carmen, San Diego? | 23.00 | | | | |
| | | | | CBS SOFTWARE | | | | | |
| | | | | Murder by the Dozen or Felony | 21.75 | | | | |
| | | | | DATABASE | | | | | |
| | | | | Alternate Reality | 25.00 | | | | |
| | | | | Bruce Lee or Conan | 22.25 | | | | |
| | | | | Zaxxon | 18.50 | | | | |
| | | | | ELECTRONIC ARTS | | | | | |
| | | | | Adventure Construction Set | 30.50 | | | | |
| | | | | Archon | 22.00 | | | | |
| | | | | Archon II or Skyfox | 24.25 | | | | |
| | | | | Bard's Tale or Beach for the Stars | 27.50 | | | | |
| | | | | Carriers At War | 30.50 | | | | |
| | | | | Europe Abilize | 30.50 | | | | |
| | | | | Micro Construction Set | 24.50 | | | | |
| | | | | One-On-One | 24.00 | | | | |
| | | | | Pinball Construction Set | 21.25 | | | | |
| | | | | Pinball Construction Set | 24.25 | | | | |
| | | | | Sumner Games I or II | 23.00 | | | | |
| | | | | Temple of Apehai Trilogy | 23.00 | | | | |
| | | | | Winter Games | 21.50 | | | | |
| | | | | Worlds Greatest Baseball Game | 20.00 | | | | |
| | | | | Worlds Greatest Football Game | 23.00 | | | | |
| | | | | SAFARI | | | | | |
| | | | | Sargon III | 27.25 | | | | |
| | | | | INFORMATION | | | | | |
| | | | | Cartoons or Zark I | 21.75 | | | | |
| | | | | Deadline, Suspended or Success | 27.50 | | | | |
| | | | | Forbidden Quest | 23.50 | | | | |
| | | | | Hitchhiker's Guide to the Galaxy | 21.75 | | | | |
| | | | | Planefall or Enchanter | 21.75 | | | | |
| | | | | Sorcerer, Suspect or Infidel | 24.75 | | | | |
| | | | | Witness or Seastalker | 21.75 | | | | |
| | | | | Zark II or Zark III | 24.75 | | | | |
| | | | | MICROPROSE | | | | | |
| | | | | Crusade in Europe | 23.75 | | | | |
| | | | | Decision in The Desert | 20.00 | | | | |
| | | | | F-15 Strike Eagle or Solo Flight | 20.00 | | | | |
| | | | | RATD Commander | 19.75 | | | | |
| | | | | MICRO LEAGUE SPORTS | | | | | |
| | | | | Micro League Baseball | 23.00 | | | | |
| | | | | Micro League Managers Disk | 23.00 | | | | |
| | | | | MINDSCAPE | | | | | |
| | | | | Crossword Magic | 28.50 | | | | |
| | | | | Holley Project | 26.00 | | | | |
| | | | | Color Me | 22.50 | | | | |
| | | | | James Bond View To A Kill | 22.50 | | | | |
| | | | | Bambo | 22.50 | | | | |
| | | | | Stephen King's The Mist | 22.50 | | | | |
| | | | | Woodoo Island | 22.50 | | | | |
| | | | | MUSE | | | | | |
| | | | | Beyond Castle Wolfenstein | 18.25 | | | | |
| | | | | Castle Wolfenstein | 18.25 | | | | |
| | | | | ORQUESTA | | | | | |
| | | | | How About a Nice Game of Chess? | 20.50 | | | | |
| | | | | ORIGIN SYSTEMS | | | | | |
| | | | | Ultima III | 33.25 | | | | |
| | | | | PENGUIN | | | | | |
| | | | | Covered Mirror | 20.50 | | | | |
| | | | | Crimson Crown | 20.50 | | | | |
| | | | | Expedition Amazon | 19.75 | | | | |
| | | | | The Quest or King Quest | 20.00 | | | | |
| | | | | Apollus or Transylvania | 20.25 | | | | |
| | | | | SIERRA | | | | | |
| | | | | Frappier 3-Drop or Super Zaxxon | 19.50 | | | | |
| | | | | Spy Hunter or Buck Rogers | 25.75 | | | | |
| | | | | Topper or Star Trek | 25.75 | | | | |
| | | | | SIERRA ON LINE | | | | | |
| | | | | King's Quest I or II | 28.00 | | | | |
| | | | | SIR TECH | | | | | |
| | | | | Wizardry I | 26.75 | | | | |
| | | | | Wizardry II | 20.50 | | | | |
| | | | | Wizardry III or Wizardry IV | 23.50 | | | | |
| | | | | Wizard | 14.25 | | | | |
| | | | | SPECTRUM HOLDITTE | | | | | |
| | | | | Gato | 21.00 | | | | |
| | | | | STRATEGIC SIMULATIONS | | | | | |
| | | | | 50 Mission Crush or Rails West | 23.00 | | | | |
| | | | | Bolic 85 or Gunstone Warrior | 19.75 | | | | |
| | | | | Battle Commander | 23.00 | | | | |
| | | | | Battle for Normandy | 23.50 | | | | |
| | | | | Genopolis 1990 | 22.75 | | | | |
| | | | | Germany 1985 or Carrier Force | 34.75 | | | | |
| | | | | Impetrium Galacticum or Broadside | 22.75 | | | | |
| | | | | North Atlantic 86 | 34.75 | | | | |
| | | | | Objective Kurik or Phantasia | 23.00 | | | | |
| | | | | Operational Market Garden | 22.25 | | | | |
| | | | | Quasars | 29.50 | | | | |
| | | | | Releaser 88 or Kampfgruppe | 34.75 | | | | |
| | | | | USAAF | 32.00 | | | | |
| | | | | War in Russia | 46.50 | | | | |
| | | | | SEIB LOGIC | | | | | |
| | | | | Flight Simulator II | 30.50 | | | | |
| | | | | Night Mission Pinball | 20.75 | | | | |
| | | | | TELARIUM | | | | | |
| | | | | Dragonworld or Shadowkeep | 22.75 | | | | |
| | | | | Fulcrum 451 or Amazon | 22.75 | | | | |
| | | | | Rendezvous with Rama | 22.75 | | | | |
| | | | | APPLE | | | | | |
| | | | | Imagewriter II W/acc. Kit | 445.00 | | | | |
| | | | | Imagewriter 15" W/acc. Kit | 470.00 | | | | |
| | | | | Lasermaster | CALL | | | | |
| | | | | BROTHER | | | | | |
| | | | | HR-15 XL | 330.00 | | | | |
| | | | | HR-25 | 450.00 | | | | |
| | | | | HR-35 | 665.00 | | | | |
| | | | | CITIZEN | | | | | |
| | | | | MSF-10 | 245.00 | | | | |
| | | | | MSF-15 | 365.00 | | | | |
| | | | | MSF-20 | 385.00 | | | | |
| | | | | MSF-25 | 505.00 | | | | |
| | | | | EPSON | | | | | |
| | | | | Spectrum LX-80 | 205.00 | | | | |
| | | | | Spectrum LX-90 W/acc. Kit | CALL | | | | |
| | | | | LX-80 Color Printer | CALL | | | | |
| | | | | APPLE COMPUTER | | | | | |
| | | | | Apple Mouse IIc | 73.00 | | | | |
| | | | | Apple Mouse IIe | 103.00 | | | | |
| | | | | Appleworks Modifier 64K | 37.50 | | | | |
| | | | | Appleworks Modifier 128K | 47.50 | | | | |
| | | | | CH NAMES | 26.25 | | | | |
| | | | | Hayes Match II | 32.25 | | | | |
| | | | | Hayes Match III | 32.25 | | | | |
| | | | | INNOVATIVE TECHNOLOGIES | | | | | |
| | | | | Pop N File 50 | 18.00 | | | | |
| | | | | KEYTRONICS | | | | | |
| | | | | KB 200 | 185.00 | | | | |
| | | | | IDEAL TECHNOLOGIES | | | | | |
| | | | </ | | | | | | |

ASTERN

ANY COMPARABLE ADVERTISED PRICE BY \$1

| | |
|------------------------------------|--------|
| SCARBOROUGH SYSTEMS | |
| Build A Book About You | 23.25 |
| Boston Computer Diet | 45.75 |
| MasterType's Writing Wizard | 45.75 |
| MasterType's Filer | 23.50 |
| MasterType's New and Improved | 23.25 |
| Run for the Money or Songwriter | 23.50 |
| SCHOLASTIC SOFTWARE | |
| Fact and Fiction Booklet I/II | 22.50 |
| Macroease 1-8 (EACH) | 22.50 |
| Story Tree or Story Maker | 22.50 |
| Turtle Tracks or Agent USA | 23.00 |
| Operation Frog or Logic Builders | 23.00 |
| Logo Robot or Kids At Work | 14.25 |
| SIMON AND SCHUSTER | |
| Chem Lab | 23.50 |
| LoveJays Preparation For The SAT | 41.50 |
| Typing Tutor III | 28.50 |
| SPINMAKER SOFTWARE | |
| Fraction Fever or Pace Maker | 14.50 |
| File and Report or Spreadsheet | 33.50 |
| Snooper Troops 1 or 2 | 19.50 |
| Story Machine or Grandma's House | 14.75 |
| Kindercomp or Kids on Keys | 14.50 |
| Spinmaker Word Processor | 33.50 |
| Alphabet Zoo or Kidwriter | 16.75 |
| In Search Of | 19.50 |
| SPRINGBOARD | |
| Early Games or Piece of Cake | 16.00 |
| Make A Match or Fraction Factory | 16.00 |
| Mask Parade | 23.50 |
| Easy As ABC | 23.50 |
| Mathbusters | 17.50 |
| TERRAPIN | |
| Terrapin Logo | 54.50 |
| Terrapin Logo 10 Pack | 177.00 |
| TIMEWORKS | |
| Evelyn Wood Dynamic Reader | 38.75 |
| WEEKLY READER | |
| Exploring Tables And Graphs 1 Or 2 | 20.50 |
| Sticky Bear Series (EACH) | 23.75 |

| | |
|------------------------------------|--------|
| INTERNATIONAL SOLUTIONS | |
| Mouse Budget | 41.00 |
| Mouse Calc | 91.00 |
| Mouse Desk | 23.00 |
| Mouse Word | 78.00 |
| Mouse File | CALL |
| KENSINGTON | |
| Format II Enhanced | 86.00 |
| LIVING VIDEOTEXT | |
| Think Tank I/II/III | 77.00 |
| MEGAHAUS | |
| Magfinder | 89.00 |
| Megaworks | 66.50 |
| MANZANITA | |
| Business Works Master Module | 67.00 |
| Manzanita GL/AR/PIV | 255.00 |
| Manzanita Payroll | 290.00 |
| MECA | |
| Managing Your Money | 102.00 |
| MICROPRO | |
| Wordstar | 168.00 |
| MICROSOFT | |
| Multiquip | 54.00 |
| MONOGRAM | |
| Dollars & Sense | 56.50 |
| Dollars & Sense IIc | 66.50 |
| Forecast | 35.00 |
| NOLD PRESS | |
| Will Writer | 28.50 |
| PBI SOFTWARE | |
| Graphworks | 58.00 |
| Jeeves | 35.00 |
| PEACHTREE | |
| Back to Basics | 98.00 |
| PINPOINT PUBLISHING | |
| Pinpoint | 35.00 |
| PRACTICORP | |
| Practical | 26.00 |
| PRECISION SOFTWARE | |
| Supercase | 53.00 |
| QUARK | |
| Word Juggler w/lexicheck | 58.75 |
| Catapult IIc | 93.00 |
| ROGER WAGNER PUBLISHING | |
| Mouse Writer | 72.00 |
| The Write Choice | 26.50 |
| ROLODEX | |
| Rolodex Compcard | 33.75 |
| Rolodex Label Express | 33.75 |
| SATELLITE SOFTWARE | |
| Word Perfect | 77.00 |
| SCARBOROUGH | |
| Net Worth | 46.50 |
| SENSIBLE SOFTWARE | |
| Bookends or Sensible Speller | 67.00 |
| The Graphics Department | 65.00 |
| Report Card | 33.00 |
| SIERRA-ON-LINE | |
| The General Manager II | 127.00 |
| Homeward | 41.00 |
| Homeward Speller | 30.00 |
| Screenwriter IIc | 73.00 |
| Homeward Writer and Speller Bundle | CALL |
| SORCIMA | |
| Supercard 3A | 100.50 |
| SOFTWARE PUBLISHING | |
| PFS: First Success | 126.00 |
| PFS: Access or Proof | 43.50 |
| PFS: File or Graph | 68.25 |
| PFS: Report or Write | 68.25 |
| STATE OF THE ART | |
| Electric Checkbook | 58.00 |
| GLAR/AP/PIV or PAYROLL | 205.00 |
| STONEWARE | |
| DB Master 4 Plus | 167.00 |
| DB Master Hard Disk | 235.00 |
| DB Master Business Writer | 87.00 |
| DB Bus. Pack or Master Bus. Team | 187.00 |
| TIMEWORKS | |
| Shiva Porter's Financial Planner | 67.00 |
| TURNING POINT | |
| Time Is Money | 57.50 |
| VIRTUAL COMBINATICS | |
| Micro Cookbook II/III | 21.50 |
| VISICORP | |
| Flashcalc | 57.00 |

| | |
|-------------------------------------|--------|
| BUSINESS | |
| ADVANCED LOGIC SYSTEMS | |
| The Handlers Package | 94.75 |
| List or Word Handler | 44.00 |
| Spellworks | 31.50 |
| APPLE | |
| Apple Writer II | 111.00 |
| Apple Access | 54.00 |
| Quickfile | 67.00 |
| APPLIED SOFTWARE TECHNOLOGY | |
| Versiform | 43.50 |
| ARTISCI | |
| Magic Office Systems | 122.00 |
| Magic Calc 3.3 | 55.00 |
| Magic Window | 76.00 |
| ASHTON TATE | |
| DBase II | 245.00 |
| BPI | |
| Gen. Acctg. AR, AP, GL, PAY | 194.00 |
| Gen. Acctg. AR, AP, GL, PAY Pro Dos | 209.00 |
| ORGANIZATIONAL SOFTWARE | |
| Omnia III | 227.00 |
| BRODERBUND | |
| Bank Street Filer | 39.50 |
| Bank Street Speller | 39.50 |
| Bank Street Writer 64K or 128K | 39.50 |
| CONTINENTAL SOFTWARE | |
| FCM/PI | 57.00 |
| Home Accountant or Tax Advantage | 37.50 |
| DOW JONES SOFTWARE | |
| Investor's Workshop | 86.00 |
| Market Analyzer or Microscope | 198.00 |
| Mk. Mgt. or Spreadsheet Link | 147.00 |
| Membership Kit | 18.00 |
| ELECTRONIC ARTS | |
| Financial Cookbook | 30.00 |
| Cart & Paste | 21.25 |
| D-Code | 21.00 |
| FUNK | |
| Sideways | 32.00 |
| HAYDEN SOFTWARE | |
| The Writer | 26.50 |
| HOWARD SOFTWARE SERVICES | |
| Real Estate Analyzer III | 185.00 |

MONITORS

| | |
|--------------------------|--------|
| APPLE | |
| Color Monitor IIc or IIc | 275.00 |
| AMDEK | |
| Color 300*** | 206.50 |
| Color 600 | 373.50 |
| Video 300A Amber*** | 116.50 |
| Video 300G Green*** | 110.50 |
| DUM III | 117.50 |
| PRINCETON | |
| HX-9 | 389.00 |
| HX-12 | 409.00 |
| RGB Interface | 140.00 |
| TAXAM | |
| 115 Green | 105.00 |
| 116 Amber | 110.00 |
| 610 | 300.00 |
| 620 | 350.00 |
| 630 | 405.00 |
| 640 | 460.00 |

MODEMS

| | |
|-------------------------------------|--------|
| ANCHOR AUTOMATION | |
| Volkmodem 1200 | 177.50 |
| Volkmodem IIc, IIc or Mac Cable | 11.00 |
| NOVATION | |
| Apple Cat II | 187.00 |
| 212 upgrade kit | 218.00 |
| 212 Applicat | 353.00 |
| APPLE COMPUTER | |
| Apple IIc, IIc or Mac Connector Kit | 23.00 |
| Apple Personal Modem | 260.00 |
| HAYES | |
| Hayes Smartmodem 300 | 132.00 |
| Hayes Smartmodem 300 IIc | 152.00 |
| Hayes Micromodem IIc w/SC I | 128.00 |
| Hayes Smartmodem 1200 | 360.00 |
| Hayes Smartmodem 2400 | 577.00 |
| PRENTICE | |
| Procap X-100 Modem | 244.00 |
| PROMETHEUS | |
| Prometheus 1200 External | 285.00 |
| Prometheus Internal IIc/II+ | 255.00 |
| Zoom Modem IIc | 114.00 |
| Zoom Modem IIc Plus | 120.00 |

UTILITY SOFTWARE/LANGUAGES

| | |
|--------------------------------|--------|
| BEAGLE BROTHERS | |
| Apple Mechanic | 15.75 |
| Beagle Basic | 18.50 |
| Disk Quick | 15.50 |
| Dos Boss | 12.25 |
| Double Take | 18.00 |
| Extra K | 21.00 |
| Fast Cat | 18.50 |
| Flex Text | 15.50 |
| GPLe | 25.50 |
| I/O Silver | 15.00 |
| Mini Pix | 14.75 |
| Mechanic | 20.00 |
| Pro Mechanic | 15.00 |
| Big U | 17.00 |
| Pro Byter | 18.50 |
| Procto Dos | 15.00 |
| Silicon Salad | 12.75 |
| Triple Dump | 20.00 |
| Type Focus | 10.75 |
| Utility City | 15.25 |
| BORLAND | |
| Turbo Pascal | 35.00 |
| Turbo Toolbox | 28.00 |
| Turbo Tutor | 20.50 |
| KENSINGTON MICROWARE | |
| System Saver | 57.50 |
| LAZERWARE | |
| Lisa II/2.6 | 52.50 |
| MICROSOFT | |
| Applesoft Compiler | 102.00 |
| Premium Softcard IIc | 247.00 |
| PERFECT DATA | |
| Perfect Data Head Cleaning Kit | 18.00 |
| QUALITY | |
| Bag of Tricks | 23.50 |
| Bag of Tricks II | 28.00 |
| ROGER WAGNER | |
| Merlin | 33.75 |
| Merlin Combo | 64.75 |
| Merlin Pro | 55.75 |
| Visible 6502 | 28.50 |
| VIDEX | |
| Ultraform w/SS Inv. | 175.00 |
| Video 7 RGB Interface IIc | 93.00 |
| Video 7 RGB Interface IIc | 84.00 |

MULTIFUNCTION BOARDS

| | |
|---------------------------------------|---------|
| APPLIED ENGINEERING | |
| Applied Eng. Trans Warp Accelerator | CALL |
| Applied Eng. Ramworks II | CALL |
| Applied Eng. Rgh Option | 100.00 |
| Applied Eng. Z Rom IIc | CALL |
| Applied Eng. System Clock | 62.00 |
| Applied Eng. Viewmaster | 102.00 |
| Applied Eng. Timemaster H.O. | 105.00 |
| Applied Eng. ISR Option | 37.00 |
| Applied Eng. Z-80 Plus | 103.00 |
| APRICORN | |
| Apricorn 16K RAM Card | 64.00 |
| Apricorn 64K Extend II | 84.00 |
| AST RESEARCH | |
| AST Mega Ram Plus | CALL |
| AST Sprint Disk | CALL |
| AST Micro Stor (10mg hd, 3.5") | 1249.00 |
| AST Micro Stor (10mg B.U.) | 589.00 |
| AST Micro Stor (10mg hd w/B.U.) | 1799.00 |
| AST Multi I/O | 152.00 |
| CARABIAN | |
| Extend 80 | 77.00 |
| CHECKMATE TECHNOLOGIES | |
| Checkmate ZEE-80A Card | 64.50 |
| Checkmate IIc-80 Ram Card | 56.50 |
| Checkmate Multiram C (256K) | 245.00 |
| Checkmate Multiram C (512K) | 310.00 |
| Checkmate Multiram IIc | 129.00 |
| Checkmate Multiview 80/160 | 206.00 |
| INFORMATION APPLIANCE, INC. | |
| Swyftcard | 69.00 |
| OHIO KACHE SYSTEMS CORPORATION | |
| Kache Board (256K) | CALL |
| OS/2 Optional Power Supply | CALL |
| PRACTICAL PERIPHERALS | |
| Serial Interface Card | 90.75 |
| Prolock IIc or IIc | 116.50 |
| Printerface | 47.50 |
| Graphiccard | 57.50 |
| QUADRAM | |
| Quadram Pro Dos Clock/Calendar | 59.00 |
| Quadram Extended Multifunction Card | 155.00 |
| Quadram Buffered Serial Int. (64K) | 95.00 |
| Quadram Parallel Interface | 65.00 |
| Quadram Parallel Card w/Graphics | 70.00 |
| Quadram 80 Column 64K Card | 97.00 |
| Quadram Multi-Care Board w/256K | 175.00 |
| Quadram E-Ram 80 | 96.00 |
| STREET ELECTRONICS | |
| Alphabits II | CALL |
| Liveness W/Clock | 70.50 |
| Business Card Serial | 131.00 |
| Business Card Parallel | 154.00 |
| THUNDERWARE | |
| Thunderclock Plus | 103.00 |
| CREATIVE PERIPHERALS | |
| Time Trax IIc or IIc | 77.50 |

ANIMATION/GRAPHICS SOFTWARE

| | |
|-------------------------------|-------|
| BAUDVILLE | |
| Actors and Actions | 16.25 |
| Blazing Paddles | 25.75 |
| Heroes and Villains | 16.25 |
| Pix It | 28.50 |
| Shape Library 1, 2 or 3 | 10.75 |
| Talk 1 | 31.50 |
| BEAGLE BROTHERS | |
| Beagle Graphics | 30.50 |
| Frame Up | 15.00 |
| BRODERBUND | |
| Dazzle Draw | 34.50 |
| Fantavision | 27.00 |
| Print Shop | 26.75 |
| Print Shop Companion | 22.50 |
| Graphics Library 1 | 14.25 |
| Graphics Library 2 | 14.25 |
| Graphics Library 3 | 14.25 |
| Refill Paper Pack | 12.25 |
| DATA TRANSFORMS | |
| Fontrix | 53.25 |
| Font Packs 1-13 | 11.00 |
| PENGUIN | |
| New Complete Graphics System | 44.75 |
| Graphics Magician | 33.75 |
| SENSIBLE SOFTWARE | |
| Graphics Department | 64.75 |
| SOFTWARE PUBLISHING | |
| PFS: Graph Dos or Pro Dos | 68.00 |
| SPINMAKER | |
| Delta Drawing | 22.75 |
| SPRINGBOARD | |
| Chip Art Effects for Newsroom | 16.25 |
| Graphics Expander I | 22.25 |
| Newsroom | 30.50 |
| WEEKLY READER | |
| Picbuilder | 21.75 |
| Zoom Graphics | 29.50 |

DISK DRIVES

| | |
|------------------------|---------|
| APPLE | |
| UNIDISK w/catalyst | 255.00 |
| Duo Disk w/casc. Kit | 425.00 |
| IIc Add On | 219.00 |
| MICRO SCI | |
| A2 143K | 152.00 |
| Slimline IIc | 152.00 |
| Slimline IIc | 159.00 |
| Controller Card | 47.00 |
| QUARK | |
| QC-10 Hard Disk, UNDER | 999.00 |
| QC-20 Hard Disk, UNDER | 1375.00 |

TELECOMMUNICATION SOFTWARE

| | |
|-----------------------------------|--------|
| APPLE COMPUTER | |
| Apple Access II | 54.00 |
| COMPUERVE | |
| Compuerve Starter Kit | 14.00 |
| DOW JONES | |
| Spreadsheet Link | 80.00 |
| Dow Jones Starter Kit | 80.00 |
| HAYES | |
| Smartscan II | 69.00 |
| Hayes Terminal Program | 54.00 |
| MICROSTUF | |
| Crosslink | 95.00 |
| QUARK | |
| Terminix | 58.75 |
| SOFTRONICS | |
| Softform II | 122.00 |
| SOFTWARE PUBLISHING | |
| PFS: Access | 42.00 |
| SOURCE TELECOMPUTING | |
| Source Subscription Kit | 25.00 |
| UNITED SOFTWARE INDUSTRIES | |
| Asci Express Pro (Dos or Pro Dos) | 74.00 |

BLANK MEDIA

| | |
|-----------------|-------|
| Elephant | |
| Elephant 55/DD | 12.00 |
| Elephant 05/DD | 15.50 |
| Verbatim 55/DD | 14.50 |
| Verbatim 05/DD | 18.50 |
| Memorex 55/DD | 14.00 |
| Basf 55/DD | 11.00 |
| Maxell 55/DD | 14.00 |

EDITORS' CHOICE

ImageWriter II: The Poor Man's Laser Printer

Apple's newest peripheral is the sleekest-looking yet. The tilt that makes the **ImageWriter II** look like a plane taking off also makes for a neat space beneath the printer for your pinfeed paper, away from any cables. This represents an improvement over the design of the original ImageWriter. The ImageWriter II also prints faster, pouring out up to 250 characters per second in draft mode. Two additional print modes, standard quality for everyday work and near-letter-quality (NLQ) for correspondence and reports, are included.

If you need a chart or graph for presentation, the ImageWriter II prints high-resolution graphics in seven colors. It has no problem handling mailing labels, envelopes, and multipart forms, as well.

Bob Ryan, contributing editor, says, "The ImageWriter II print speed is great, and the printer is durable enough to stand up under a lot of wear and tear. It's the poor man's laser printer."

Review editor Paul Statt notes, "This is the first of many peripherals that will work with both the Apple II series and the Mac. Apple promises that all its peripherals will work with either system in the very near future."

Managing editor Dawn Matthews happily disconnected her Scribe and nabbed the new ImageWriter II as soon as it arrived at the *inCider* offices. It hooked up easily to her //c: "As usual, the manual has clear directions—Apple always has great docs. I had a good time running the test for color printing and using the accompanying DiskWare utility to print pictures of Einstein and Shakespeare. I've had a problem seeing the green print-selection and on/off lights in a brightly lit room, though."

Accessories available for the ImageWriter II include a 32K Memory Option your dealer can install in an existing expansion slot in the printer. (The printer comes with a 2K buffer.) The special SheetFeeder inserts individual pages and stacks them after printout to make large printing jobs easier. A third option is the AppleTalk hardware/software setup that lets your printer serve up to 31 computers in a local-area network. AppleTalk is currently available for the Macintosh, and an Apple II version is in the works.

The ImageWriter II lists for \$595; the 32K Memory Option is priced at \$99; the SheetFeeder costs \$225; and the AppleTalk connector kit is \$50 per computer, from Apple Computer, 20525 Mariani Avenue, Cupertino, CA 95014. ■

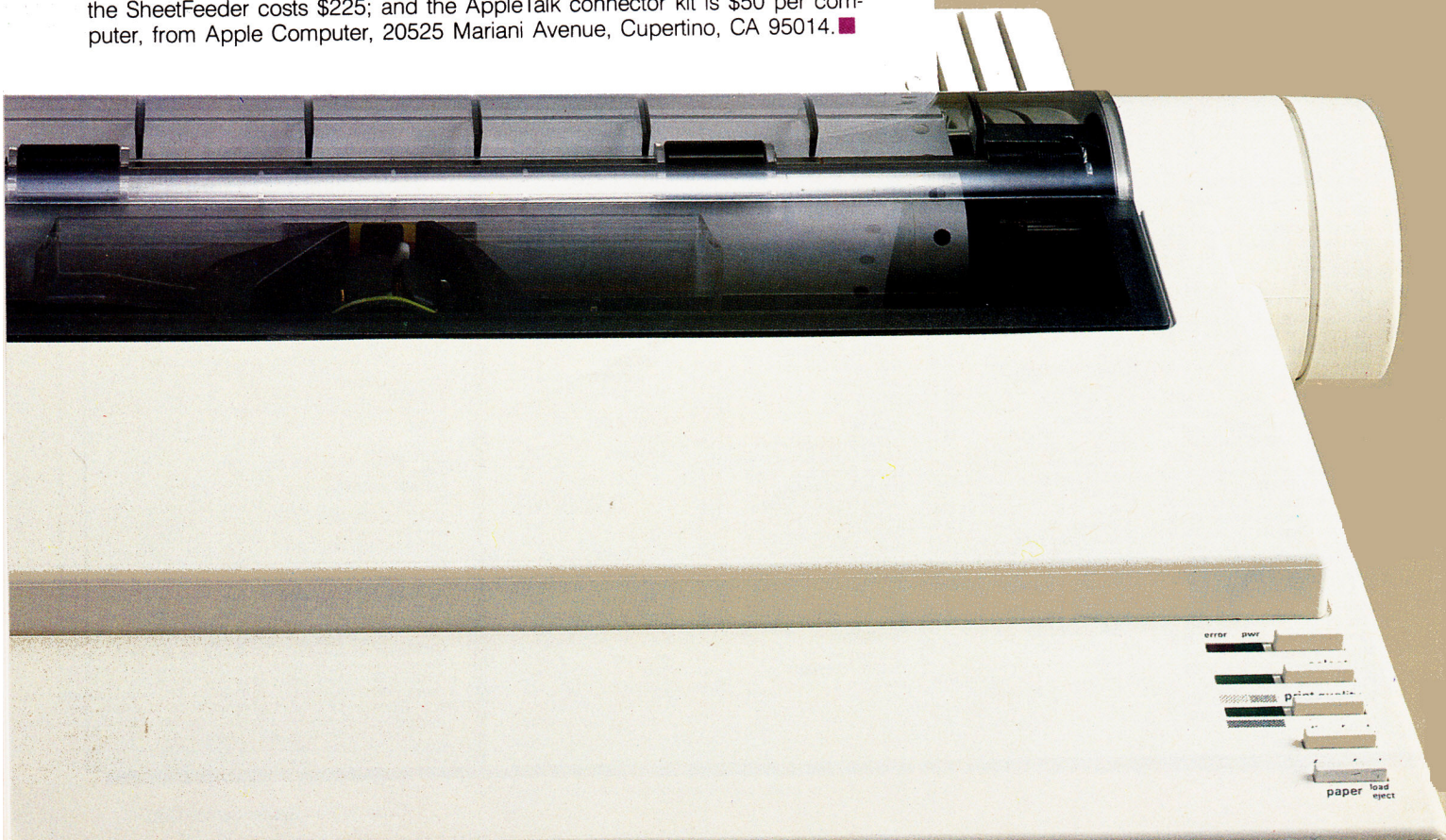

Let's compare ApplesTM to ApplesTM.



An Apple IIc



An Apple IIc with Z-RAM

The Apple IIc on the right works exactly the same as the Apple IIc on the left. Almost. The Apple on the right has a powerful memory expansion coprocessing card called Z-RAM. From Applied Engineering. Which means the Apple on the right can completely load AppleWorks into RAM—and then run it up to thirty times faster than the Apple on the left.

Z-RAM also acts as a solid-state disk drive. Which means the Apple on the right will load and store programs up to 30 times faster. And, our included RAM disk is compatible with Applesoft, PRO-DOS, DOS 3.3, PASCAL and CP/M.

Turbo Charged AppleWorks.

Even a 256K Z-RAM can completely load AppleWorks into RAM. With Z-RAM, the moment your fingers touch the keyboard AppleWorks responds. A 256K Z-RAM lets your IIc run AppleWorks up to 30 times faster, increases available desktop to 235K and maximum number of records from 1,350 to over 15,000, quadruples the number of lines allowed in the word processor, provides a print spooler, and auto-segments large files so they can be saved on two or more disks. A 512K Z-RAM boosts AppleWorks desktop to an incredible 425K.

Take a closer look.

There's more. Z-RAM has a built-in high speed Z-80B microprocessor that allows you to run CP/M programs. Which means you now have access to the single largest body of software in existence, including popular packages like WordStar, dBase II, Turbo PASCAL and Microsoft BASIC. A 16 bit option is also available.

And still more. Z-RAM is compatible with all IIc software and hardware, installs easily in just ten minutes with a screwdriver (slightly longer without), is available with 256K or 512K of additional memory (a 256K Z-RAM can be upgraded to 512K at

any time). Z-RAM is easily handled by the IIc power supply with our patent pending power saving design.

The only thing better than that would be a recommendation from Steve Wozniak.

"I recommend Applied Engineering products wholeheartedly." (Of course, Steve's IIc has a Z-RAM installed.)

*Steve Wozniak, the creator
of Apple Computer*

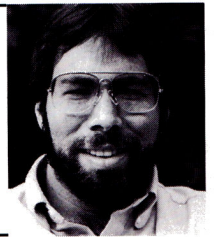

For fast response.

Z-RAM comes complete with simple instructions, RAM disk software, Z-80 operating system, CP/M manual. And a five year "hassle free" warranty. Make a good Apple great. With 256K Z-RAM "384K total" (\$329); with 512K "640K total" (\$389); 16 bit option may be added later (\$89).

If you want to run CP/M software, but don't need more memory, we suggest our Z-80c card. The Z-80c has no memory expansion ports and is priced at only \$159.

Call 214-241-6060 TO ORDER TODAY. 9 a.m. to 11 p.m. Seven days, or send check or money order to Applied Engineering. MasterCard, Visa and C.O.D. welcome. Texas residents add 5% sales tax. Add \$10.00 outside U.S.A.

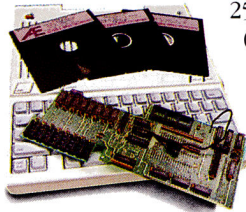

AE Applied Engineering
P.O. Box 798, Carrollton, TX 75006
(214) 241-6060



How fast is the other Apple II desk organizer? Hold your breath.

How fast is Jeeves? Well, you want your appointment calendar, your phone dialer/directory, calculator, memo pad, alarm clock? Done. Instantly. That's how fast Jeeves is.

Are you still holding your breath? Good. Just another 10 seconds. *Jeeves*[™]

PBI Software Inc. 1111 TRITON DRIVE, 2ND FLOOR, FOSTER CITY, CA 94404 (415) 349-8765
JEEVES, THE AFFORDABLE PERSONAL ASSISTANT, \$49.95. WORKS WITH OR WITHOUT APPLE WORKS. TO FIND OUT MORE ABOUT JEEVES SEE YOUR LOCAL COMPUTER SOFTWARE DEALER OR ORDER DIRECTLY FROM US BY CALLING 800-843-5722; OR IN CALIFORNIA, CALL 800-572-2746 9AM-5PM PST.
JEEVES IS A TRADEMARK OF PBI SOFTWARE. APPLE AND APPLEWORKS ARE TRADEMARKS OF APPLE COMPUTER, INC. SOFTWARE TESTED WITH APPLE IIC.