



\$2.95
JULY 1986
VOLUME 4
ISSUE 7

PRINT IT!

Your Apple II and the LaserWriter

Apple II/Macintosh

THE INDEPENDENT GUIDE TO APPLE COMPUTING

D SPELLING
CHECKERS
COMPARED



EASY
MACINTOSH
ACCOUNTING

UN IIe
SOFTWARE
IN YOUR III



COMMON-SENSE
REPAIRS

AT LAST!

**APPLE II
DESKTOP
PUBLISHING**

Unleash the  *Amazing Powers*
 of the **LASERWRITER**
 with your **APPLE II!**

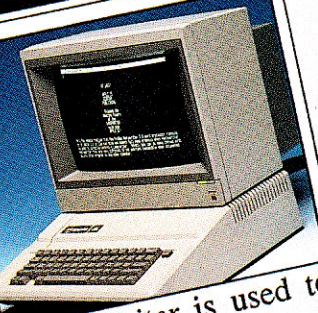
Very few people realize that the ProDOS Apple Writer 2.0 word processor running on an Apple IIc or IIe can give you superb full page graphics when directly control a LaserWriter. In fact, you can do many things with Apple Writer that are very difficult if not outright impossible when attempted by any other program on any computer 

*****3-DIGIT 371
#GAS0116S091 8#680488 8H

DR KENNETH BUCHHOLZ
WWW.APPLE2ONLINE.COM



Introducing the Most Powerful Business Software Ever!

FOR YOUR IBM • APPLE • MAC • TRS-80 • KAYPRO • COMMODORE • MSDOS OR CP/M COMPUTER*

OVER
100,000
SOLD

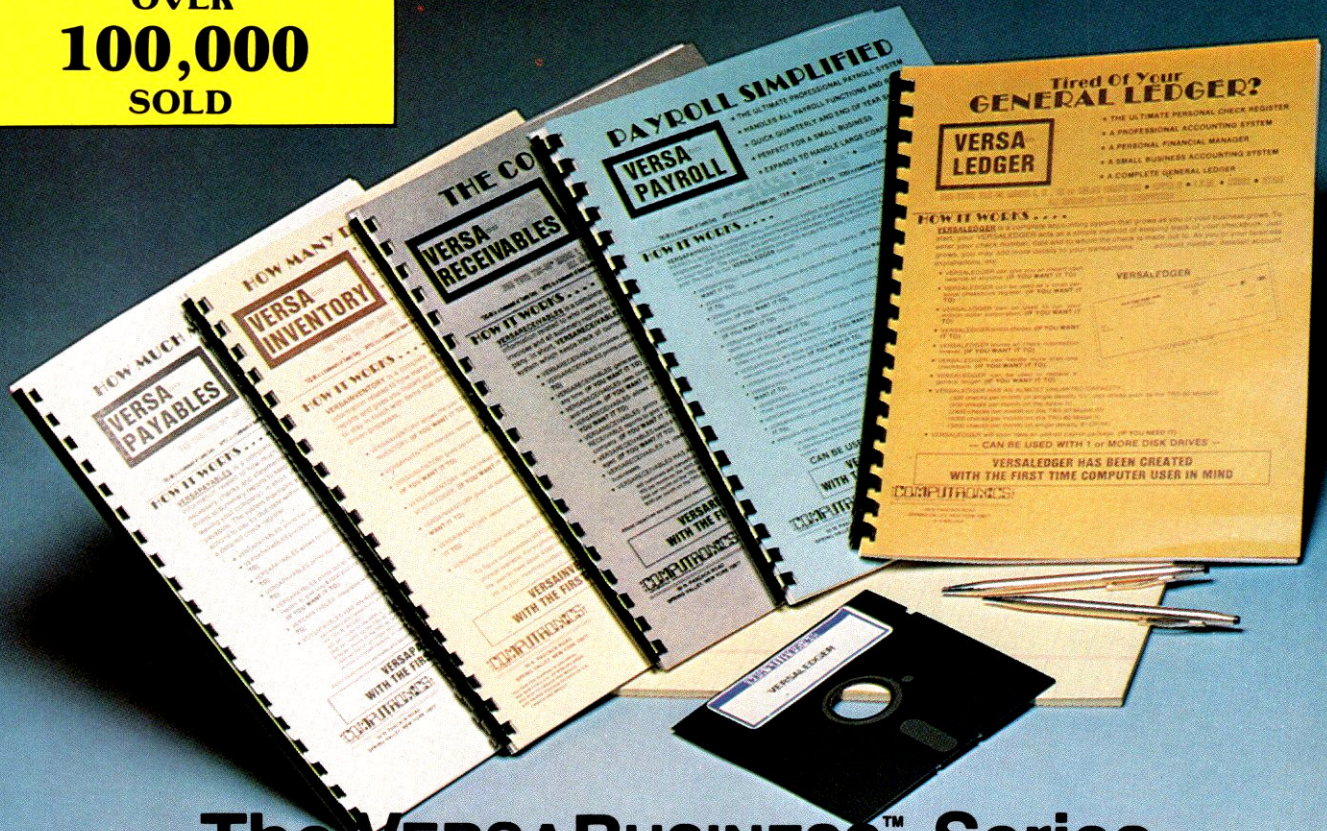

The VERSABUSINESS™ Series

Each VERSABUSINESS module can be purchased and used independently, or can be linked in any combination to form a complete, coordinated business system.

VERSARECEIVABLES™

\$99.95

VERSARECEIVABLES™ is a complete menu-driven accounts receivable, invoicing, and monthly statement-generating system. It keeps track of all information related to who owes you or your company money, and can provide automatic billing for past due accounts. VERSARECEIVABLES™ prints all necessary statements, invoices, and summary reports and can be linked with VERSALEDGER II™ and VERSAINVENTORY™.

VERSAPAYABLES™

\$99.95

VERSAPAYABLES™ is designed to keep track of current and aged payables, keeping you in touch with all information regarding how much money your company owes, and to whom. VERSAPAYABLES™ maintains a complete record on each vendor, prints checks, check registers, vouchers, transaction reports, aged payables reports, vendor reports, and more. With VERSAPAYABLES™, you can even let your computer automatically select which vouchers are to be paid.

VERSAPAYROLL™

\$99.95

VERSAPAYROLL™ is a powerful and sophisticated, but easy to use payroll system that keeps track of all government-required payroll information. Complete employee records are maintained, and all necessary payroll calculations are performed automatically, with totals displayed on screen for operator approval. A payroll can be run totally, automatically, or the operator can intervene to prevent a check from being printed, or to alter information on it. If desired, totals may be posted to the VERSALEDGER II™ system.

VERSAINVENTORY™

\$99.95

VERSAINVENTORY™ is a complete inventory control system that gives you instant access to data on any item. VERSAINVENTORY™ keeps track of all information related to what items are in stock, out of stock, on backorder, etc., stores sales and pricing data, alerts you when an item falls below a preset reorder point, and allows you to enter and print invoices directly or to link with the VERSARECEIVABLES™ system. VERSAINVENTORY™ prints all needed inventory listings, reports of items below reorder point, inventory value reports, period and year-to-date sales reports, price lists, inventory checklists, etc.

VERSALEDGER II™

\$149.95

VERSALEDGER II™ is a complete accounting system that grows as your business grows. VERSALEDGER II™ can be used as a simple personal checkbook register, expanded to a small business bookkeeping system or developed into a large corporate general ledger system **without any additional software.**

- VERSALEDGER II™ gives you almost unlimited storage capacity (300 to 10,000 entries per month, depending on the system),
- stores all check and general ledger information forever,
- prints tractor-feed checks,
- handles multiple checkbooks and general ledgers,
- prints 17 customized accounting reports including check registers, balance sheets, income statements, transaction reports, account listings, etc.

VERSALEDGER II™ comes with a professionally-written 160 page manual designed for first-time users. The VERSALEDGER II™ manual will help you become quickly familiar with VERSALEDGER II™, using complete sample data files supplied on diskette and more than 50 pages of sample printouts.

SATISFACTION GUARANTEED!

Every VERSABUSINESS™ module is guaranteed to outperform all other competitive systems, and at a fraction of their cost. If you are not satisfied with any VERSABUSINESS™ module, you may return it within 30 days for a refund. Manuals for any VERSABUSINESS™ module may be purchased for \$25 each, credited toward a later purchase of that module. All CP/M-based Computers must be equipped with Microsoft BASIC (MBASIC or BASIC 80).

To Order:

Write or call Toll-free (800) 431-2818
(N.Y.S. residents call 914-425-1535)

- add \$3 for shipping in UPS areas
- add \$4 for C.O.D. or non-UPS areas
- add \$5 to CANADA or MEXICO
- add proper postage elsewhere

DEALER INQUIRIES WELCOME

All prices and specifications subject to change / Delivery subject to availability.

COMPUTRONICS

50 N. PASCACK ROAD, SPRING VALLEY, N.Y. 10977



Children's Software from Springboard™

The best way to introduce your child to the computer.

Early Games for Young Children™

This popular program offers a delightful collection of games designed to teach children ages 2½ to 6 a variety of important basic skills in a fun and friendly way.

Children learn to distinguish shapes, recognize letters, say the alphabet, count, add, subtract, even spell their names!

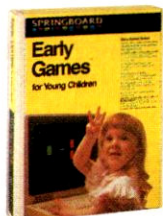

Large, colorful letters, gentle hints and a picture menu help children learn without adult supervision.

It's the perfect way to introduce your child to the computer.



Early Games



Easy as ABC

Satisfaction Guaranteed

At Springboard, we stand behind our products.

That's why we offer a full 30-day money-back guarantee. Look for these and other Springboard products for all ages at your favorite software store.

Now Available For:
Macintosh
 Apple II+, IIe, IIc, IBM PC, PCjr,
 Commodore 64/128

Easy as ABC™

Learning the alphabet is a wonderful new adventure with Easy as ABC. Five fun games introduce children ages 3 to 6 to letter recognition, alphabetical sequence and upper/lower case letters.

Delightful animals present the alphabet in a variety of ways. Jumping frogs, buzzing bees and soaring rockets fascinate your children as they learn. And multiple skill levels keep them interested so they learn more.

No other program teaches your children the alphabet as thoroughly.

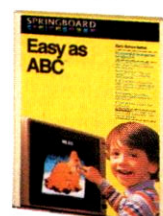

SPRINGBOARD



Springboard Software, Inc. • 7808 CreekrIDGE Circle • Minneapolis, MN 55435 • (612) 944-3915

CIRCLE 261 ON READER SERVICE CARD



Why The Biggest Names In Soft AST's SprintDisk™ Memory

AST and leading software manufacturers are working together to break new ground, establish new standards and provide new solutions that enhance the power of your Apple II for your serious business and educational needs.

In making their hardware compatibility choices — choices that can make or break their companies — the

*The most current versions
SprintDisk, SprintCache trademarks and SixPakPlus registered trademark of AST Research, Inc. Apple registered trademark and Apple II, Macintosh, AppleWriter II, AppleWorks and ProDOS trademarks of Apple Computer, Inc. BusinessWorks is a trademark of Manzanita Software Systems. MouseWrite is a trademark of Roger Wagner Publishing, Inc. Dollars and Sense is a trademark of Monogram. BPI and BPI Systems are trademarks of BPI Systems, Inc. Sensible Speller is a trademark of Sensible Software, Inc. Mouse Calc and Mouse Desk are trademarks of Version Soft. SuperCalc 'a is a registered trademark of Sorcim/IUS Micro Software. A Division of Computer Associates International, Inc. PFS, Write, PFS, Plan, PFS: Report, PFS: File and PFS: Graph are registered trademarks of Software Publishing Corporation. Catalyst is a trademark of Quark Incorporated. ReportWorks registered trademark of Megahouse Corporation. Pinpoint is a trademark of Pinpoint Publishing and Virtual Combinatics, Inc. Managing Your Money registered trademark of Micro Education Corporation of America.
Copyright © 1986 AST Research, Inc. All rights reserved.

software leaders look to AST, the hardware leader with the proven track record. So should you.

AST is the world's leading supplier of enhancement products for personal computers with a well-earned reputation for outstanding quality and reliability. We offer a full-line of products for the Apple II and Macintosh™ families. And you've heard of our award-winning SixPakPlus® multi-function card for the IBM PC — the defacto industry standard with well over 500,000 shipped.

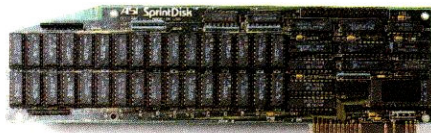

**Introducing SprintDisk:
Up To 2 MB Of Memory
Expansion And All The
Software Compatibility,
With None Of The
Modifications.**

The new generation memory card is here, now you can break the 64K barrier with all the software compatibility you need. Designed for use as a rapid-access, mass-storage device, SprintDisk provides up to 2 Megabytes of desktop workspace for your spreadsheets, word processing documents and databases.

Good-bye Software Patches.
With SprintDisk you can take advantage of expanded memory while saying "good-bye" to the hassles of modi-



ware Are 100% Compatible With Expansion For The Apple II.™

fications. All your favorite applications software* (those illustrated above and more) are completely, automatically and immediately compatible. Of course, SprintDisk is ProDOS™, DOS 3.3 and Pascal 1.3 compatible.



The Speed of AST's SprintCache™ Buffer. We include exclusive utility software — we call it SprintCache — so if you are using multiple storage devices, you can also use SprintDisk as a caching buffer. It allows you to cache up to fourteen floppy, hard-disk or tape drives for higher performance and greater productivity.

Hardware Facts. SprintDisk is compatible with the Apple II Memory

Expansion board. It's fully socketed and user-upgradeable with 256 Kb chips. And it comes with its own RAM diagnostic software.

The Quality, Service and Support of an Industry Leader.

AST's worldwide reputation is built on quality. SprintDisk features the highest-quality four-layer construction and undergoes extensive testing and comprehensive burn-in procedures for the ultimate in reliability — AST has the lowest product failure rate in the industry. And don't forget our two-year warranty, world-renowned service and customer support.

For more information call (714) 476-3866 or circle the reader service below.

- FEATURES**
- SprintDisk
 - Up to 2 MB Total Memory
 - 256 Kb to 1.0 MB on mainboard
 - Up to 1.0 MB additional memory on piggyback card
 - Apple II Memory Expansion board compatible
 - SprintCache for fast, user-transparent disk/tape caching
 - ProDOS, DOS 3.3 and Pascal 1.3 compatible
 - No application software modifications necessary
 - Fits any I/O slot except #3 in II, II+ or IIfx
 - Fully socketed and user-upgradeable

CIRCLE 323 ON READER SERVICE CARD

**AST
RESEARCH INC.**



Flight Simulator II

For Apple II,
Apple II+, & Apple IIe



Put yourself in the pilot's seat of a Piper 181 Cherokee Archer for an awe-inspiring flight over realistic scenery from New York to Los Angeles. High speed color-filled 3D graphics will give you a beautiful panoramic view as you practice takeoffs, landings, and aerobatics. Complete documentation will get you airborne quickly even if you've never flown before. When you think you're ready, you can play the World War I Ace aerial battle game. Flight Simulator II features include ■ animated color 3D graphics ■ day, dusk, and night flying modes ■ over 80 airports in four scenery areas: New York, Chicago, Los Angeles, Seattle, with additional scenery areas available ■ user-variable weather, from clear blue skies to grey cloudy conditions ■ complete flight instrumentation ■ VOR, ILS, ADF, and DME radio equipped ■ navigation facilities and course plotting ■ World War I Ace aerial battle game ■ complete information manual and flight handbook.

See your dealer . . .

or for direct orders enclose \$49.95 plus \$2.00 for shipping and specify UPS or first class mail delivery. American Express, Diner's Club, MasterCard, and Visa accepted.

Order Line: 800 / 637-4983

subLOGIC
Corporation
713 Edgebrook Drive
Champaign IL 61820
(217) 359-8482 Telex: 206995



Publisher
 Sydney H. Rogers
Editor in Chief
 Maggie Canon
Executive Editor
 Frederic E. Davis
Technical Editor
 Chip Carman
Senior Copy Editor
 Eva Langfeldt
Managing Editor
 Leslie Steere
Assistant Editor
 Carol Person
Office Manager
 Marjorie Gae Brandon
Contributing Editors
 Chris Albertson, Mary Bohannon,
 Michael Callery, Charles Doherty,
 Russ Lockwood, Steve Rosenthal,
 Charles Rubin, Vanessa Schnatmeier,
 Roberta Schwartz, Rhoda Simmons,
 David Thornburg, Michael Wiesenberg
Art Director
 Peter A. Tucker
Associate Art Director
 Fabian Cooperman
Art Assistant
 Ae Kyung Kuark
Mechanical Artists
 Steve Campbell, Nancy Brown

Editorial Office: 11 Davis Drive, Belmont, CA 94002; (415) 598-2290
 Advertising/Business Office: Ziff-Davis Publishing Company,
 One Park Avenue, New York, NY 10016, (212) 503-5105
 Subscription Inquiries and Service: A+, P.O. Box 2965, Boulder, CO 80322,
 (303) 447-9330

Advertising Director
 Suzanne M. Zellner
Northwest Manager
 Thomas E. Richardson
Mid-Atlantic/Southeast Manager
 Chris M. Tice
Mid-West Manager
 Thomas J. Lutzke
Northwest Manager
 David J. Ezequelle
Southeast Manager
 Cynthia L. Ramsey
Telemarketing Manager
 Leslie Phillip
Advertising Coordinator
 Ilene Morris
Account Representatives

NORTHEAST Robert Sullivan
MID-ATLANTIC Peter Stangel
SOUTHEAST Susan Relihan
MID-WEST Peter Stangel
NORTHWEST Peter Longo
SOUTHWEST Susan Relihan
 Helen Kempisty
 Robert Woltersdorf
 Charles Mast

Assistant to Publisher
 Single-Copy Sales Director
 Circulation Manager

ZIFF DAVIS PUBLISHING COMPANY

President
 Kenneth H. Koppel
Senior Vice President, Marketing
 Paul Chook
Vice President, Operations
 Baird Davis
Vice President, Controller
 John Vlachos
Vice President, Creative Services
 Herbert Stern
Vice President, Circulation
 Alicia Marie Ivans
Vice President, Circulation Services
 James Ramaley
Vice President, Marketing Services
 Ann Pollak Adelman
Vice President, Development
 Seth Alpert
Vice President
 Hugh Tietjen
Business Manager
 Gary A. Gustafson
Production Director
 Walter J. Terlecki

ZIFF COMMUNICATIONS COMPANY
President
 Philip B. Korsant
Executive Vice President
 James D. Dunning, Jr.
Senior Vice President
 Kenneth H. Koppel
Senior Vice President
 Philip Sine
Vice President
 Laurence Usdin
Vice President
 William Phillips
Vice President
 J. Malcolm Morris
Vice President
 Steven C. Feinman
Treasurer
 Selwyn I. Taubman
Secretary
 Bertram A. Abrams

A+ is an independent journal, not affiliated in any way with Apple Computer, Inc. Apple is a registered trademark of Apple Computer, Inc. Entire contents Copyright © 1986 Ziff-Davis Publishing Co. All rights reserved; reproduction in whole or in part without permission is prohibited. The following are trademarks of Ziff-Davis Publishing Co.: A+, A+: The Independent Guide for Apple Computing, MacTips, Rescue Squad, That's Entertainment.
 Permissions: Material in this publication may not be reproduced in any form without permission. Requests for permission should be directed to the Licensing Manager, Jean Lamensdorf, Ziff-Davis Publishing Company, 1 Park Ave., New York, NY 10016. BPA membership (Selected Market Audit Division) applied for October 1983.



YOUR SECOND CHANCE AT LIFE

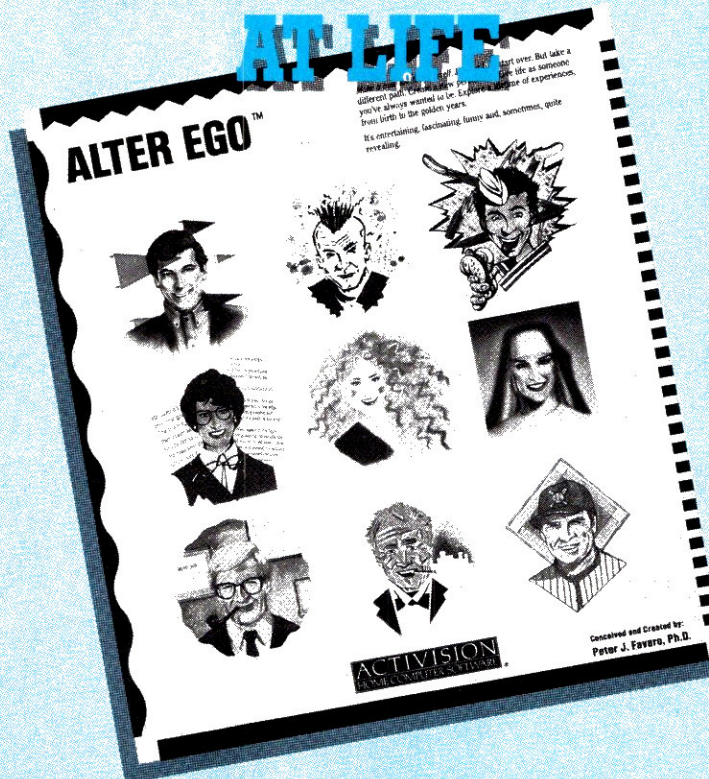

Ever have one of those days when you wish you were anyone but yourself? Now with Alter Ego™, you can.

Alter Ego, Activision's fantasy role-playing game lets you experiment with "What if" . . . just for the fun of it.

Hundreds of entertaining life situations lie in store for you. Explore new options. Make new choices. Let your

computer track your development through 7 life stages, from infancy through the golden years.

Become a high-powered executive. A rock star. A beach bum. Or the President of the United States.

Alter Ego. Ground breaking entertainment packed into 3 disks. Have all the fun of living a secret life. Without any of the risk.



ALTER EGO™

Conceived and Created by Peter J. Favaro, Ph. D.

Male and Female versions available for Apple II series, IBM PC/PCjr and compatibles, Tandy 1000, Commodore 64 and 128 and Macintosh computers.

Commodore 64 and 128 are trademarks of Commodore Electronics Limited. Apple and Macintosh are trademarks of Apple Computer. IBM is a trademark of International Business Machines Corp. Tandy is a trademark of Tandy Corp. Activision is the registered trademark of Activision, Inc. © 1986 Activision, Inc.



CIRCLE 174 ON READER SERVICE CARD

Contents

JULY 1986/VOLUME 4/ISSUE 7

Downloaded from www.Apple2Online.com



THE INDEPENDENT
GUIDE TO
APPLE COMPUTING

COVER STORY

22

APPLE II DESKTOP PUBLISHING

BY STEVE ROSENTHAL

If you thought that the LaserWriter was only for the Macintosh, think again, and read this article. With some software and a little bit of simple programming, Apple II owners can access the power of the LaserWriter to produce typeset-quality documents.

HARDWARE

30

HARDWARE HARD LUCK AND HOW TO HANDLE IT

BY HENRY F. BEECHHOLD

Any hardworking computer will break down sooner or later. Before you panic, realize that with a little bit of common sense and some simple tools, you can probably conquer the problem. We'll teach you some of the basics in this tutorial on how to handle hardware problems yourself.



42

APPLE III ALTER EGO

BY CHRIS ALBERTSON

There was a time when Apple II owners longed for a device that would allow their machine to emulate the Apple III. As irony would have it, Apple III owners may now want to convert in the opposite direction, and Titan Technologies has just the set of plug-in boards that let your Apple III emulate the IIe.



SOFTWARE

48

SPELL IT WRITE

BY SUSAN JANUS

As many of us already know, no matter how important the information, spelling and typographical errors reflect poorly on the writer. Help is available, though. Software publishers have developed an array of stand-alone and built-in spelling checkers to work in conjunction with word-processing programs. This article and its accompanying chart present many of the spelling checkers you may be considering.

DEPARTMENTS

9

EDITORIAL

11

LETTERS

15

NEWSPLUS

BY FREDERIC E. DAVIS

News and views of the personal-computer industry

65

THE LEARNING CURVE

BY DAVID D. THORNBURG

This month's column concentrates on a new "construction set" authoring system for the Apple IIe and IIc. Tutor Tech from Techware, Inc., deserves a close look by teachers interested in creating instructional software, according to Thornburg.



67

COMPUTER CALISTHENICS

BY MICHAEL WIESENBERG

The absentminded clerk strikes again: More misplaced multiplying makes mischief.

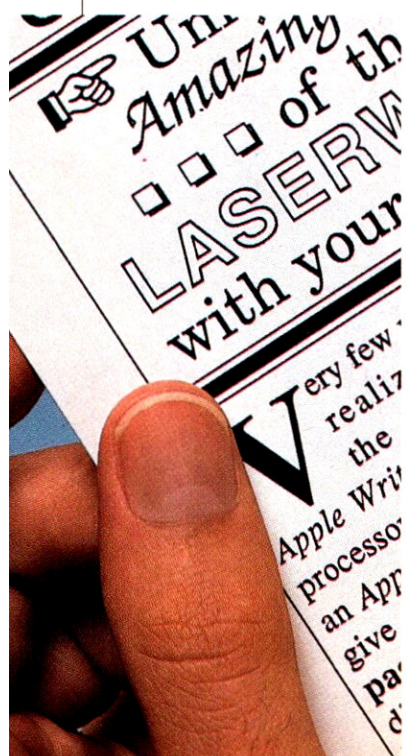

DEPARTMENTS, Continued

73

THAT'S ENTERTAINMENT

Reviews of Carriers at War from Strategic Studies Group/Electronic Arts; Essex from Synapse/Brøderbund; STAR TREK: The Kobayashi Alternative from Simon & Schuster, Inc.; and King's Quest II: Romancing the Throne from Sierra On-Line, Inc.

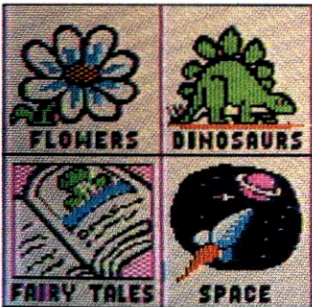

87

SPEAKING OF GRAPHICS

BY ROBERTA SCHWARTZ AND MICHAEL CALLERY
Graphics programs for kids: This month Schwartz and Callery look at four graphics programs for introducing children to computers, including Color Me, Designer's Pencil, PictureWriter, and Rainbow Painter.

112

PIPELINE

BY CAROL PERSON AND RHODA SIMMONS
Products you want to know about—for the entire Apple-computer line



129

THOUGHTWARE

BY STEVE ROSENTHAL
Putting the desktop in its place: This month Steve Rosenthal discusses the converging path of the Apple II and Macintosh computers.

133

RESCUE SQUAD

BY CHRIS VAN BUREN AND GARY B. LITTLE
Understanding the difference among AppleWorks versions and programming double-width, high-resolution graphics in Applesoft

136 **A+ MART**

138 **A+ DIRECTORY**

141 **MACINTOSH DIRECTORY**

142 **INDEX TO ADVERTISERS**

144 **COMING SOON**

The Macintosh Section

93

68000 ASSEMBLY-LANGUAGE PROGRAMMING, PART II

BY GARY B. LITTLE
This article is the second in a series of three articles designed to introduce you to 68000 assembly-language programming on the Macintosh. In part I last month, author Gary Little gave an overview of the instructions and registers the 68000 uses. This month, he gives a general review of the instruction set for the 68000 and then concentrates on addressing modes.

98

PEGBOARD ACCOUNTING SYSTEMS

BY RUSEL DEMARIA
Pegboard, or one-write, accounting systems have been popular with small business for many years because they are simple and easy to use. Now computer programmers are discovering how naturally the pegboard system fits into computerized accounting. Rusel DeMaria reviews two such products for the Macintosh, Plains & Simple from Great Plains Software and MacOneWrite from Sierra On-Line.

107

SILICON PRESS

BY S. VENIT
If you are tired of hassling with printing cards, stickers, and labels, be sure to read this review of Silicon Press, which, according to this reviewer, is an incredible time saver.

110

MACTIPS

Suggestions from our readers

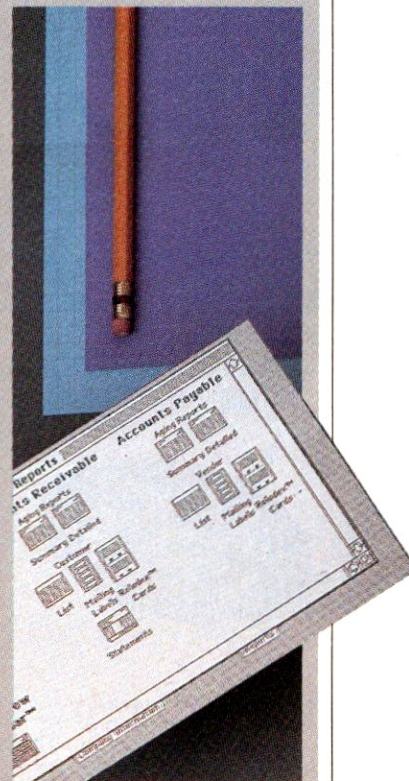

(No I.D. required for half-elves.)

When the Going Gets Tough, the Bard Goes Drinking.

And the going is tough in Skara Brae town. The evil wizard Mangar has cast an eternal winter spell. Monsters control the streets and dungeons beneath. Good citizens fear for their lives. What's worse, there's only one tavern left that serves wine. But the Bard knows no fear. With his trusty harp and a few rowdy minstrel songs he claims

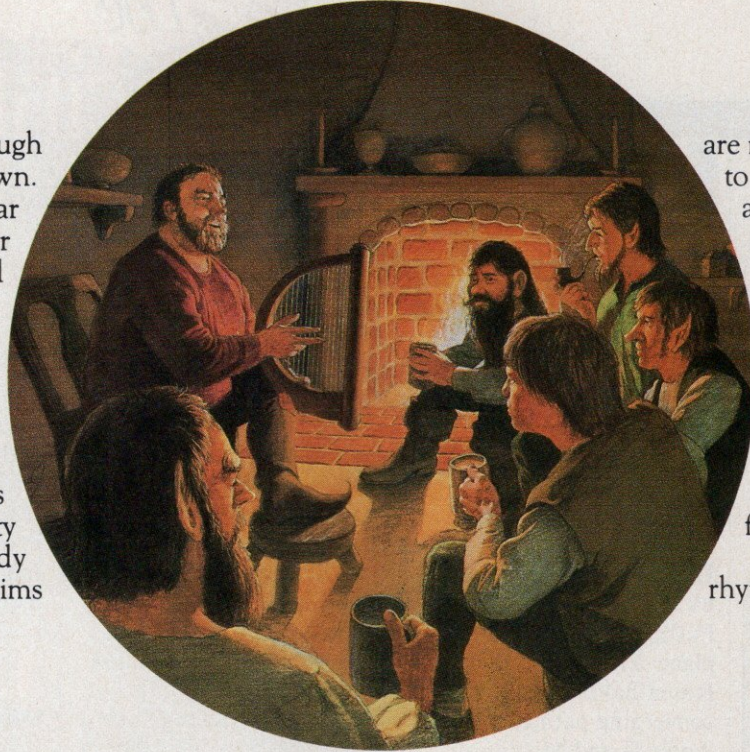

are magic, the Bard is ready to boogie. All he needs is a band of loyal followers: a light-fingered rogue to find secret doors, a couple of fighters to bash heads, a conjurer to create weird allies, a magician for magic armor. Then it's off to combat, as soon as the Bard finishes one more verse. Now what's a word that rhymes with "dead ogre?"

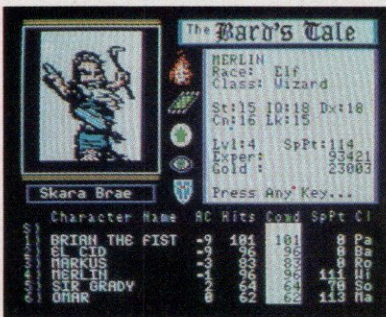

4 classes of magic user, including wizard and sorcerer. 85 new magic spells in all.

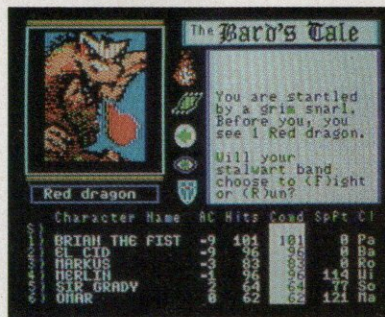

128 color monsters, many animated. All challenging.



Full-color scrolling dungeons. 16 levels, each better than the one before. 3-D city, too.

Optional use of characters created in Wizardry® or Ultima III.®

The Bard's Tale™

from



ELECTRONIC ARTS™

Specs: 100% machine language, 400K worth on 2 disks. 64K RAM minimum; enhanced for 128K. Now available for Apple II family for \$44.95, C-64 & 128 for \$39.95. To order: Visit your retailer or call (800) 245-4525 (In Calif. call (800) 562-1112) for VISA or MasterCard orders. To purchase by mail, send check or money order to Electronic Arts, P.O. Box 7530, San Mateo, CA 94403. Add \$5 for insured shipping and handling. Allow 1-4 weeks for delivery. The Bard's Tale is worth the wait. Apple is a trademark of Apple Computer. Wizardry is a registered trademark of Sir-Tech Software, Inc. Ultima is a registered trademark of Richard Garriott. The Bard's Tale and Electronic Arts are trademarks of Electronic Arts. For a copy of our complete catalogue and direct order form, send \$.50 and a stamped, self-addressed envelope to Electronic Arts, 1820 Gateway Drive, San Mateo, CA 94404.

Message from Maggie

DESKTOP PUBLISHING

Every year a special subject sparks the imagination of the computer industry. This year a major focus is on desktop publishing, which is a significant new way to use microcomputer hardware and software.

Desktop publishing refers to the use of personal computers, page printers, and page-layout software to produce typeset-quality documents at a small fraction of the cost of traditional typesetting.

Until recently, most companies and publishers created typeset documents by employing outside services for typesetting, page layout, and pasteup. Although this process is effective in producing high-quality materials, it is also expensive and time-consuming. The single most important factor in changing the way typeset materials are produced is the advent of laser printing, and the introduction of Apple Computer's LaserWriter in 1985 started the desktop-publishing revolution, even though other laser printers were already available. The LaserWriter was the first low-cost laser printer that contained a powerful built-in computer that used the PostScript page-description language to control the creation of typefaces in a wide variety of styles and fonts. With the power of laser typography accessible to personal computers, suddenly the private domain of typeset-quality publishing opened up to anybody with access to a personal computer, a laser printer, and the appropriate software.

At this point, you may be thinking that there is one large problem with this rosy scenario of publishing becoming the province of personal computers—the Apple II isn't in the picture, because the LaserWriter was built for the Macintosh. Well, we have a pleasant surprise for Apple II owners: The LaserWriter works quite well with the

Apple II series; you just have to know how to tap the hidden resources of PostScript contained inside the LaserWriter.

Keeping up with this desktop-publishing revolution is the subject of this month's cover story. We are proud to bring you the details of how to make your Apple II control the LaserWriter to produce professional-looking typeset materials.

To help prove the validity of using an Apple II and the LaserWriter as a desktop-publishing solution, we had our cover illustrator create this month's cover art with an Apple IIe, a LaserWriter, and the Apple Writer II word-processing program. The cover artist, Don Lancaster, is a pioneer in the computer industry, as well as a champion of the Apple II. Lancaster feels the Apple II should definitely not be overlooked by the desktop-publishing market. As a matter of fact, he ardently believes the Apple II can take better advantage of the LaserWriter than the Macintosh can, since the Macintosh does not make full use of PostScript. You can use the Apple II to program the LaserWriter's powerful built-in PostScript controller and achieve special effects that Macintosh applications don't offer. Don's package of LaserWriter utilities for Apple Writer II proves this point, and Steve Rosenthal includes this software in our cover story.

Since so many Apple IIs are in use in small and medium-size businesses, where desktop publishing will flourish, we predict increasing interest in using the Apple II as part of desktop publishing. This month's article is the first of several we will provide to keep you, your Apple II, and your business up to date in this promising area. +

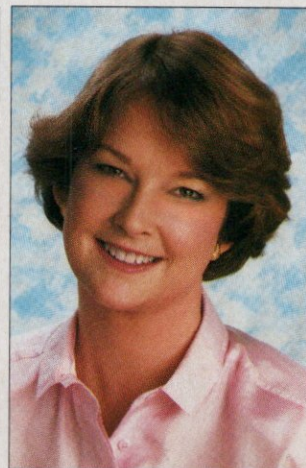

The LaserWriter works quite well with the Apple II series; you just have to know how to tap the hidden resources of PostScript contained inside the LaserWriter.

Maggie Canon

MAGGIE CANON/EDITOR IN CHIEF

THE AMERICAN WAY TO THE TOP

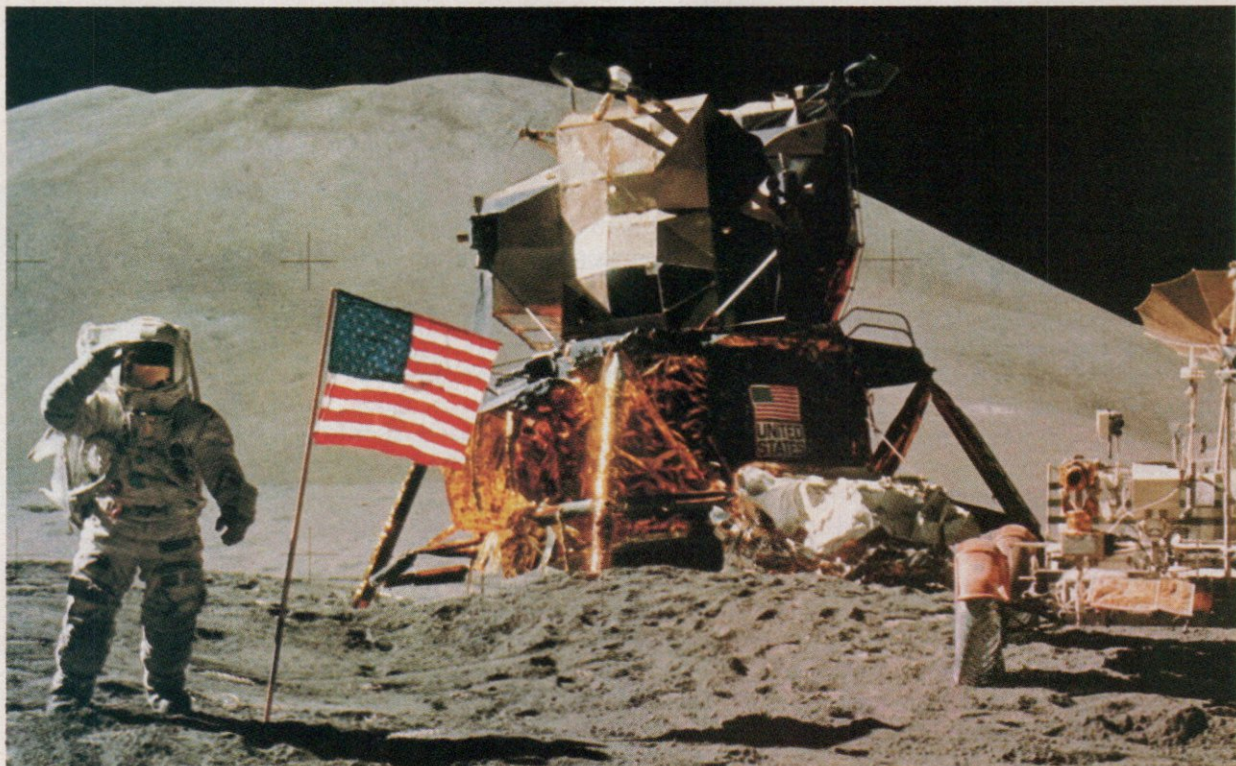

This July 4th, we at Applied Engineering hope that all Americans will take time out to ponder who and what we are.

It is hoped that we can remind ourselves what it means to be an American.

We invented the telephone, the electric light, the phonograph, and the airplane. Americans invented the first vacuum tube, transistor and the integrated circuit, without which the personal computer would have been impossible. Over 95% of the world's new inventions are invented by Americans. We lead the world in all phases of technology; electronics, physics, chemistry, health science, space and robotics. We've sent men to the moon, landed a robot on Mars, and sent our probes out across the galaxy! Americans by their very nature are inventors, thinkers, winners and doers.

America is a country where two young men started a company in their garage and three years later Apple Computer is the industry leader. Applied Engineering started much the same way and we became the leading Apple peripheral manufacturer, with no outside sales force, no marketing strategy,

and no commissioned sales people.

Our business plan at Applied Engineering is simple. BE THE BEST. That means producing tomorrow's peripherals today, it means hard work, high quality, total dedication to Apple Computer and good service at competitive prices.

While some other guys are losing the ball game . . . we're adding to our roster. In the past few months, we've added 4 new products to our line up for a total of 26 and we're working on more. We've added more order lines and more knowledgeable people to serve you.

While others look to the Orient for solutions to their engineering and manufacturing problems, we at Applied Engineering feel differently because we know America's inventive past and her inventive future and we're excited.

To quote Dr. Robert Goddard in a letter to H. G. Wells, "There can be no thought of finishing, for 'aiming at the stars,' both literally and figuratively, is a problem to occupy generations, so that no matter how much progress one makes, there is always the thrill of just beginning."



APPLIED ENGINEERING
The Apple enhancement experts.

We invite your comments.

Letters

CUSTOM SOLUTION

Dear A+: A while ago (in the October 1985 issue), I read the comments of letter writer S. Richard Ravich on the lack of support for his Starfire drive, and I heard a familiar ring. I own a Rana Elite II floppy-disk drive and wanted to use its extended capacity under ProDOS, but no support was available. Being fed up with this situation, I decided to modify the ProDOS 1.1.1 diskette driver to recognize my drive's abilities. I purchased a copy of *Beneath Apple ProDOS* by Quality Software, and, after many many hours of work, I now can use ProDOS with my expanded drive as well as with the Elite I or III drives. In this time when computer users are subject to the whims of hardware manufacturers, it's nice to know you can tip the scales with the abundant information available on the Apple II—a luxury many other microcomputer owners do not enjoy. If any are interested in the modifications, use the following address.

L.D. Crandall
P.O. Box 386
Bonita, CA 92002

LOGICAL EXTREMES

Dear A+: To comply with Dr. John Caruso, Jr.'s request ("Letters," May 1986) I suggest that Apple Computer change its Macintosh manual to depict one male and one female each of the following: white, black, Hispanic, American Indian, oriental, and "other." And to complete the 24 pictures, one each of the above but handicapped (or gay). And if there are still complaints by some minorities, they should start deleting text and replacing it with the respective pictures un-

til we have a nice album of all possible ethnic, sexual, and other distinctive characteristics and all possible combinations of them. Never mind the primary object of the manual, which is to convey information about a computer, not to play ridiculous political games.

Roberto Restrepo, M.D.
Fort Worth, TX

BEYOND BASIC

Dear A+: I was so pleased at David Thornburg's "Learning Curve" column on the shortcomings of Apple-soft BASIC in your February 1986 issue that I was inclined to write you a letter of thanks. Time passed, and I neglected to do so. However, in view of recent criticisms by letter writers Allan Porter and Allan Mahler (April 1986), I feel I must respond.

Mr. Porter says the column was a disservice to your readers. If he feels that the airing of alternative views is a disservice, I suggest he begin lobbying Congress immediately for the repeal of the first amendment. Thornburg stuck to the facts in his article. Every criticism he cited was well founded.

I do not differ with the letter writer on the fact that "the genesis of any computer program is inside the human skull." Indeed, this is where all the great inventions of mankind begin. Given a creative thought, however, available tools must be used to implement that thought. Throughout history, in all professional fields, old tools have often been discarded for new ones that lead to higher quality and productivity. Worldwide, study after study has shown that the use of structured languages, such as Pascal,

lead to more reliable programs and more productive programmers.

As for Mr. Mahler, I'm sorry if his body cannot stand the tremendous physical strain of having to enter TWO WHOLE CHARACTERS for an assignment operator (Pascal's :=). I certainly am glad I do not have to read any of his programs if the number of keystrokes per line is his prime consideration.

The writer is correct about English. It is far from perfect. That is why engineers, mathematicians, musicians, and professionals in countless other fields have all adopted other, more precise, notations for their craft. As the demands of their work increased, the notations they used were often traded for more useful conventions. Why should the profession of computer programming be different?

As for the writer's difficulty in having a Pascal program write to the printer while the program is running, I have had the opportunity to experience both Apple Pascal and Turbo Pascal and have had no such trouble with either.

In Turbo, there is a built-in logical output device (LST) that allows you to do this directly. In Apple Pascal, you need merely to open the printer device (PRINTER:) as an output file. In both cases, this information is readily available in the language manual. One has to wonder how open-minded Mr. Mahler was about Pascal as he allegedly "fought for a few months" with a language frequently taught to college freshmen in a ten-week quarter.

As for criticism of the "experts," they have something that the writer, because of his attitude, will never achieve. They have the experience of working with *many* programming languages. They do not believe Pascal is perfect, any more than they believe BASIC is perfect. Both BASIC and Pascal are merely single steps in the evolution of computer languages. Indeed, Niklaus Wirth, the creator of

Pascal, accepted criticisms of his own language and created a new language (Modula-2) to correct some of its shortcomings. Now *that* is open-minded!

Remember, when it first appeared, BASIC was very "different." Indeed, the B in BASIC stands for *beginners*. Those who wish to continue using beginners' tools should step aside and allow the rest of us to progress to Pascal and beyond!

Dale E. Courte
Dayton, OH

CD-ROM APPLICATION

Dear A+: I recently read your article entitled "Optical Data Storage" in the April 1986 issue of A+ and found it very interesting. Compact Disc Read-Only Memory (CD-ROM) technology certainly is an innovation in data storage that holds many great possibilities.

The article mentioned that Reference Technology has developed the application of a database covering toxicology and drug interactions. The database you referred to is the Com-

puterized Clinical Information System (CCIS) of Micromedex, Inc. I would like to point out that although Reference Technology assembles the CD-ROMs, the database is actually produced and sold by Micromedex, Inc. of Denver, Colorado.

In 1985, Micromedex, (which had been producing medical databases on microfiche since 1974), became the first company to produce a database using the CD-ROM. The Computerized Clinical Information System of Micromedex includes the Poisindex, Drugdex, Emergindex, and Indentindex databases. The system is currently used by physicians, pharmacists, nurses, and other allied health professionals in hospitals, drug and poison centers, clinics, and physician's offices throughout the world.

Nancy E. Kuchta
Micromedex, Inc.
Denver, CO

FAIRNESS IN UPDATES

Dear A+: Recently, on the strength of articles in your magazine, I purchased Mouse Calc from International Solutions. It was version 1.0. After spending the weekend playing around with it, I called the company in California long distance from the Chicago area to ask some questions. Then I found out that a new version 1.2 was out and that I would have to pay for it.

COME ON NOW!! I had owned the program for three days and was being told that I could update it for a service charge. The president, Mr. Mark Kuamme, and I went at it for about ten minutes, and I came away no better than before. He thinks it is fair to ask new users to pay for updates even if they have just bought the program, and I think it stinks! He even welcomes my bitch letters to the press and helped me spell his name correctly. I assume because of all the thousands of dollars they spend in your magazine, you won't have the guts to print bad press about him. Please tell me you have more morals than that. After all, you have the duty to present both sides to your readers and inform them. Your only loyalty should not be to your advertisers.

I believe a \$10 update is extremely fair for registered users, but that during the warranty period, especially the first week of ownership, updates should be automatic, free, and fast.

Kenneth Clybor
Wheeling, IL

UPTIME

• THE DISK MONTHLY •

Get 120 programs for less than 60¢ each!

Make your life easier and get more from your computer.

Organize your life and be more productive with our home management and finance programs. Have fun learning with educational programs and fun relaxing with games and adventures. You'll find business, graphics, utilities and more!

Ten programs and more on every disk — a wealth of information. **Subscribe now!**

Make the very next disk yours! Fill in the coupon and return it to us.

We make it easy and inexpensive — a disk each month.

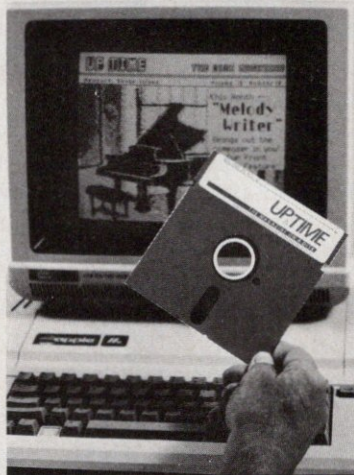

Free Offer!

Take advantage of this introductory offer! Subscribe and receive **Mail Magic FREE!** Add, edit, or delete names and addresses; sort by name, city, state or zip; print labels and more. Yours with any purchase below.

Offer expires June 30, 1986

For Immediate Service Call Us Toll-Free: **1-800-437-0033**

In Rhode Island: 1-401-849-4926

I'LL BYTE!!! I'm a computer enthusiast who wants more. Please start my subscription to UPTIME immediately. I want:

12 Disk Issues \$66 **6** Disk Issues \$48 **3** Disk Issues \$30 **1** Disk Issue \$11.95

(Add \$2 per issue in foreign countries, except Canada and APO)

Name _____
Address _____
City _____ State _____ Zip _____

- Please send my free **Mail Magic** disk.
 Payment enclosed. (Please make checks payable to UPTIME.)
 Bill my: VISA MASTERCARD

Account No. _____ Expiration Date _____

Signature _____

- Please send information on UPTIME for Macintosh.

Send to: UPTIME, PO BOX 299, NEWPORT, RI 02840.

Subscribe now and save. You won't believe the value! Satisfaction guaranteed.

CIRCLE 219 ON READER SERVICE CARD

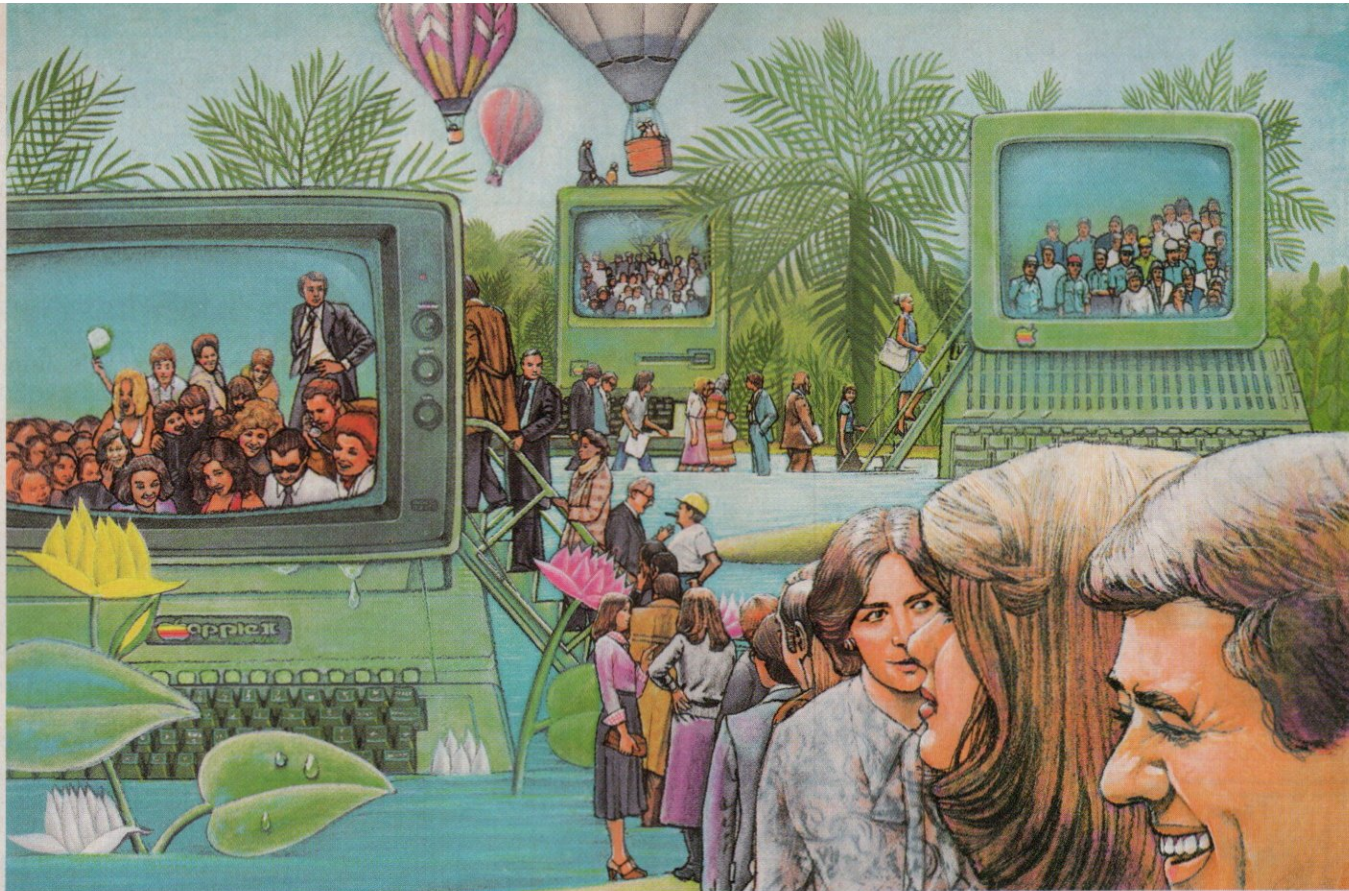

USE THE BRAINS YOUR APPLE WASN'T BORN WITH.

Right at your fingertips in CompuServe's Apple® Forums.

Join the CompuServe **Apple II and III Forum** to swap everything from tall tales to short cuts with other users, and explore thousands of classic programs stockpiled since 1979.

Swap programs and files with fellow Mac owners in our **Macintosh® Users Forum**. Questions? You'll get answers from the experts here!

Visit the **Macintosh Developers Forum**. Get updates to the "Inside Macintosh Software Supplement." Interact with the Mac "team" in Cupertino.

The **Apple User Groups Forum**, supported by Apple Computer, unites officers of Apple user groups—"ambassadors" for hundreds of thousands of Apple-active enthusiasts worldwide.

Easy access to free software.

- Download *First-rate, non-commercial, user-supported software and utility programs.*
- Take advantage of CompuServe's

inexpensive weeknight and weekend rates (when Forums are most active, and standard online charges are just 10¢ a minute).

- Go online in most major metropolitan areas with a local phone call.
- And receive a **\$25.00 Introductory Usage Credit** with purchase of your CompuServe Subscription Kit.

Information you simply can't find anywhere else.

Use the Forum *Message Board* to send and receive electronic messages, and pose specific questions to Apple owners.

Join ongoing, real-time discussions in a Forum *Conference*—with Apple luminaries like Bill Atkinson, Doug Clapp, Dan Cochran, Jean-Louis Gasse, Mark Pelczarski, John Sculley and Steve Wozniak.

Search Forum *Data Libraries* for free software, user tips, transcripts of previous CompuServe online conferences and more.

Enjoy other useful services like:

- **Popular Computer Magazines**—electronic editions, for your reading pleasure. Including **Apples Online**, which reprints

articles from leading user group newsletters nationwide and other Apple-related publications.

- **Other CompuServe Forums**—supporting Jazz™ and other LOTUS® products. Microsoft®, MicroPro®, Borland International®, Ashton-Tate®, and other software. Also Pascal, Basic, C, Forth, Assembly and other programming languages.

All you need is your Apple computer and a modem ... or almost any other personal computer.

To buy your Subscription Kit, see your nearest computer dealer. Suggested retail price is \$39.95. To receive our free brochure, or to order direct, call 800-848-8199 (in Ohio, call 614-457-0802). If you're already a CompuServe subscriber, type GO MAUG (Micronetworked Apple Users Group) at any ! prompt to see what you've been missing.

CompuServe®

Information Services, P.O. Box 20212
5000 Arlington Centre Blvd., Columbus, Ohio 43220

800-848-8199

In Ohio, Call 614-457-0802

An H&R Block Company

CIRCLE 271 ON READER SERVICE CARD

A+ MAGAZINE/JULY 1986 ▶ 13

CHARTS!

FOR THE APPLE II

- Create charts in seconds
- Print on almost any printer

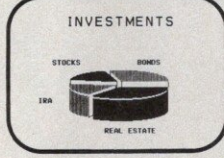
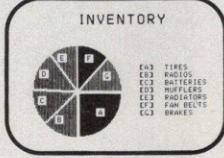
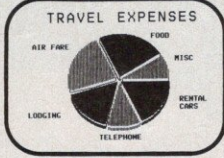
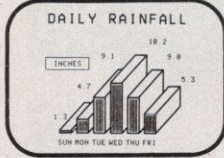
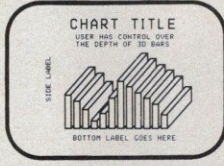
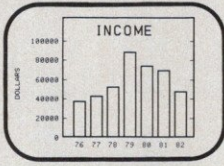
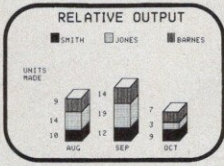
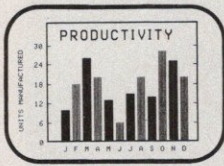

AlphaChart. 2D/3D bar and pie charts. Extras include powerful draw, type, and slide show programs. 26 chart styles. \$29.95.

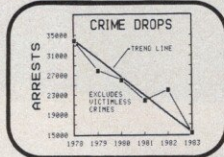
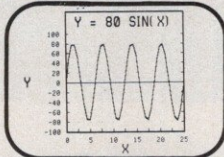
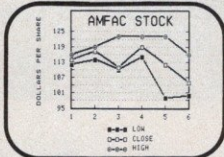
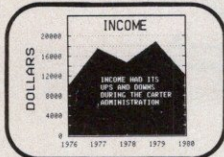
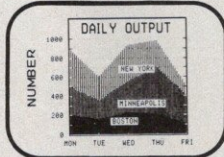
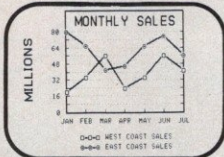
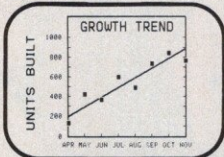
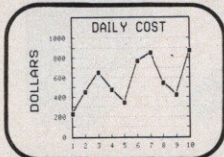

CurvePlotter. Line, area, trend, and math function charts. Up to three curves per chart, 100 points per curve. 12 chart styles. \$29.95.

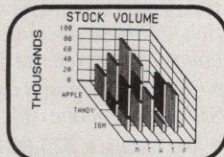
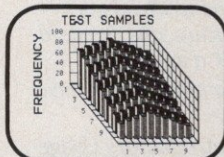
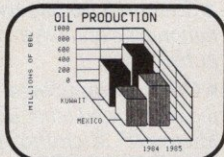
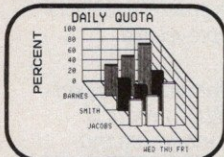
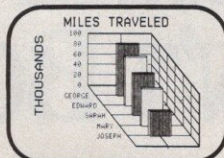
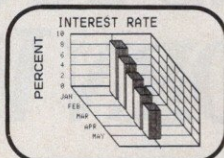
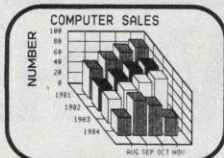
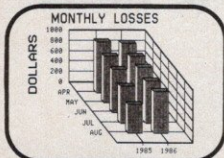

3DChart. Nothing else like it! 3D bars plotted versus two variables on a 3D grid. Up to 144 bars. 14 chart styles. \$29.95.

Save \$20! Order any two disks for \$39.90.
Save \$40! Buy all three disks for \$49.85.

- Check/VISA/MasterCard/COD
 - 3 months money-back guarantee
- Or, send \$3.00 for a really great demo disk and a 24 page instruction manual



800-826-2989 (Nationwide)
 800-231-7316 (California)

SPECTRAL GRAPHICS SOFTWARE

6333 Pacific Avenue
 Stockton, CA 95207
 (209) 473-2862

CIRCLE 139 ON READER SERVICE CARD

CORRECTION

In the Apple Cable Connection chart starting on page 58 of our June 1986 issue, all references to cable number 590-0037 should have listed the pin configuration as *Match identical pin numbers*. Apple's cable specifically matches pin numbers 1, 2, 3, 4, 5, 6, 7, 8, 12, 13, 19, 20, and 23 so that you can use it for a variety of peripherals, as the chart indicates. For cable number 590-0335, all the first and second numbers in the pin configuration should be reversed. Also, the Apple III contains a Serial Card III, not a Super Card III.

NO ESKIMOS, EITHER

Dear A+: This is a letter in response to that written by a "Dr." Caruso in your May 1986 issue. I am wondering if he has anything better to do than to look through books and magazines categorizing the races and creeds of those depicted. Has it not occurred to Dr. Caruso that Apple felt it too stupid, to say the least, to hire a representative of each minority to hold a mouse in different chapters of the manual, rather than just use one model? It's the type of person that looks at us as white or black or Indian that prevents us from accepting one another. It's "racially sensitive" people like him that cause the problems. I, personally, am not offended that I did not see an amputee or an Eskimo or even a Latvian in the manual.

Robert Voldemar Zimmers (age 16)
 Tacoma, WA

COMPUTER COMPETITION

Dear A+: We at the Crittenden Middle School love reading your magazine, and we are hoping you can help us out with a competition we are planning. Our computer lab recently ran a contest using a program called Academic Jeopardy. The scores were almost all perfect. This led us to believe we needed some more difficult questions!

We are now compiling a list of questions for a new contest, which I am currently writing and have named Middle School Bowl. We need a variety of questions and answers on all subjects that will reasonably tax a middle schooler's brain. If your readers wanted to contribute to our program, we would greatly appreciate it.

Jessica Wright
 Computer Lab, H.C. Crittenden
 10 McDonald Street
 Armonk, NY 10504

BY FREDERIC E. DAVIS

NewsPlus

*Just imagine
this high-
resolution
monitor on a
next-generation
color Macintosh!*

SONY'S NEW INCREDIBLE MONITOR/TV

Sony has developed a near-flat 41-inch-diagonal Trinitron cathode-ray tube (CRT) with a maximum horizontal resolution of 1861 pixels. Each pixel is composed of a phosphor trio of red, blue, and green dots that can combine to make virtually any color.

Sony says the tube was developed for use in CAD/CAM applications and eventually for the Japanese Hi-Vision HDTV (High Definition TV) system being proposed as a future television standard to give TV pictures many times the picture quality of today's sets. Don't expect to be able to run right out and buy these, though. Sony recently announced

**SONY'S NEW 41-INCH HIGH-
DEFINITION VIDEO SYSTEM
(HDVS) COLOR MONITOR**



a prototype model of a monitor based on the tube, with a resolution of more than 1000 lines horizontally and more than 750 lines vertically, which is available only to developers for the small sum of about \$40,000 each. Sony officials claim the picture quality is good enough for displaying color slides with barely any loss of quality. Just imagine that monitor on a next-generation color Macintosh. Wow!

DESKTOP PUBLISHING

Desktop publishing, a term coined by Paul Brainerd of Aldus Corporation, is definitely one of the most commonly heard computer buzzwords these days. Many people, including myself, feel that desktop publishing represents a major new use of personal computers. I started exploring the use of personal computers in electronic-publishing systems five years ago, when I used an Apple II to create documents for the computer typesetting of a plant dictionary I was writing, using the TeX typesetting language developed at Stanford University. I inserted the TeX commands into a database

template on the Apple and then telecommunicated the files to a DEC System 20 mainframe for processing.

Times have changed. The TeX typesetting language no longer requires a mainframe; in fact, Addison-Wesley has recently introduced a version of TeX that runs on the Macintosh. An advantage of

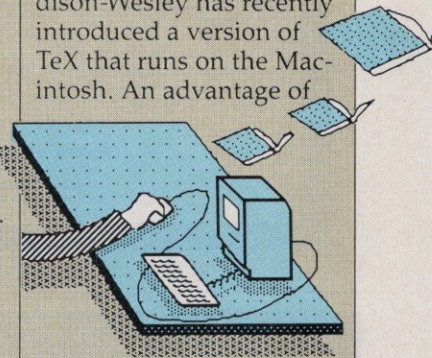

TeX over page-layout programs such as PageMaker is that TeX works with ordinary text files from almost any program. You can now create word-processing, database, or other files that contain embedded TeX instructions on your Apple II and transfer them to a Macintosh for typesetting and printing on the LaserWriter or a Linotronic typesetting machine—a good example of how the Mac and the II can work together effectively.

The Apple II is an excellent low-cost data-entry workstation that costs less than some terminals yet offers local disk storage and processing. The Mac, with a megabyte of RAM and a 32-bit processor, is as powerful as the mainframes of yesteryear and can handle complex tasks, such as TeX processing,

DIGITAL VISION

COMPUTEREYES™

VIDEO IMAGES ON YOUR COMPUTER!

Finally—an inexpensive way to capture real-world images on your computer's graphics display! COMPUTEREYES™ is an innovative slow-scan device that connects between any standard video source (video tape recorder, video camera, videodisk, etc.) and your computer. Under simple software control, a b/w image is acquired in less than six seconds. Unique multi-scan modes also provide realistic grey-scale images. Hundreds of applications!

Package includes interface module, complete easy-to-use software support on disk, owner's manual, and one year warranty all for \$129.95 plus \$4.00 S&H (USA).

Also available as a complete package including:

- COMPUTEREYES™
 - Quality b/w video camera
 - Connecting cable
- for only \$399.95 plus \$9.00 S&H.



Demo disk available for \$10.00 postpaid (refundable).

See your dealer or order direct. Mass. residents add 5% sales tax. Mastercard, Visa accepted. To order, or for more information, write or call:

DIGITAL VISION, INC.
14 Oak Street — Suite 2
Needham, MA 02192
(617) 444-9040, 449-7160

ONLY \$129.95

- Available for:
- Apple II series
 - Commodore 64/128
 - Atari 800/800XL/65XE/130XE

CIRCLE 170 ON READER SERVICE CARD

FREE!

DATA ACQUISITION • GRAPHICS • DATA ANALYSIS

PRODUCT CATALOGS FOR YOUR

IBM or Apple PC

Interactive Microware offers a complete, low cost family of high quality hardware and software for **Chromatography • Process Control • Spectrophotometry • Temperature Monitoring • Electrochemical Analysis • Atomic Absorption • Instrument Monitoring • Data Plotting • Curve Fitting • IR and UV/VIS Spectroscopy • Computer Assisted Design** and Much More!

Thousands of clients worldwide use IMI products for Science, Engineering and Business Applications.

CALL (814) 238-8294 FOR IMMEDIATE ACTION!

IBM 48 PAGES 94 PRODUCTS

APPLE 64 PAGES 264 PRODUCTS

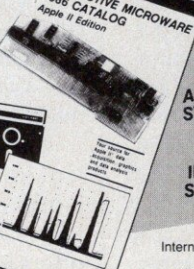
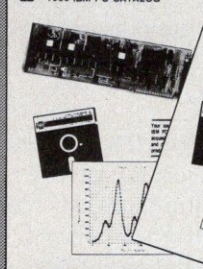

featuring

COMPLETE APPLE II WORKSTATIONS STARTING AT \$ 2220

COMPLETE IBM PC WORKSTATIONS STARTING AT \$ 3595

IBM is a registered trademark of International Business Machines Corp. Apple is a registered trademark of Apple Computer, Inc.



INTERACTIVE MICROWARE, INC.
POB 139, Dept. 209, State College, PA 16804
Phone: (814) 238-8294 • Telex 705250

CIRCLE 324 ON READER SERVICE CARD

NewsPlus

that are beyond the capability of an Apple II.

For more information about desktop publishing, take a look at *Desktop Publishing* from Dow Jones-Irwin, of which I was coauthor. Two A+ people helped out: A+'s senior copy editor, Eva Langfeldt, contributed as a writer and editor, and the book was formatted and indexed by Michael Wiesenberg, author of A+'s "Computer Calisthenics" column, using the aforementioned TeX typesetting language.

prevalent today.

Another interesting potential is the possibility of being able to read information on IBM PC diskettes with an Apple II or Macintosh, and vice versa. This development would create a significant level of data compatibility among various models of IBM and Apple computers.

ARMY TO USE VIDEO GAMES FOR TRAINING

We have been receiving an incredible number of war-related computer games lately, including Colonial Conquest, Battle Group, and Nam from Strategic Simulations; Under Fire from Avalon Hill; Ancient Art of War from Brøderbund; and Europe Ablaze from

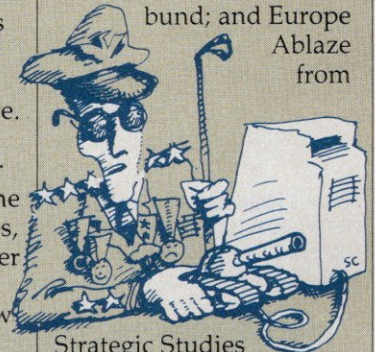

Strategic Studies Group/Electronic Arts. And now I've just found out that the U.S. Army has been taken with the war-game/simulation craze. The Army's way to do it was to award a \$57.8 million contract to a firm called Perceptronics, Inc., located in Woodland Hills, California, to create a computer-controlled battlefield simulation.

APPLE HARD DISK UPGRADES. ONE SIZE FITS ALL.



It's also reassuring to know that the ProApp 10 and 20 are designed and manufactured by some of the same team of experienced professionals who helped the industry leaders perfect their hard disk systems.

MONEY-BACK GUARANTEE.

Each ProApp 10 and 20 hard disk comes with a "no risk" money-back guarantee. Order the ProAPP and use it for up to 10 days. If you're not 100% satisfied with its performance, return it for a complete refund.

ORDER TODAY. CALL 800-424-2425.

To order your ProAPP 10 or 20, or for additional information, call toll-free. Use the coupon below and charge it to your VISA, MasterCard or American Express card, or send money order and get next week, UPS surface delivery. Allow approximately 30 days for personal checks to clear.

PROAPP™ 1475 S. Bascom Avenue
Campbell, CA 95008

Apple is a registered trademark, MAC and Macintosh are licensed trademarks, and ProDOS, Pascal 1.3, Ile and Iic are trademarks of Apple Computer, Inc. ProAPP is a trademark of ProAPP, Inc. All disk capacities are listed as formatted. © 1986 ProAPP, Inc.

Yes! Rush me the ProAPP hard disk system specified below, including all cables, manuals and software.

_____ ProAPP 10MB Hard Disk(s) at \$795 each (includes shipping, handling and sales tax).

_____ ProAPP 20MB Hard Disk(s) at \$995 each (includes shipping, handling and sales tax).

To receive correct cable kit, please specify your machine:

I have a MAC Plus MAC 128/512 Ile Iic

Name _____ Company _____

Shipping Address _____

City/State/Zip _____

Phone (____) _____

I've enclosed my check or money order for \$ _____

Please bill the following credit card account for \$ _____

VISA MasterCard American Express Card Exp. Date _____

Card # _____

Signature _____

Mail to: ProAPP, Inc., 1475 S. Bascom Ave., Campbell, CA 95008

A+ 7-86

FULLY COMPATIBLE WITH APPLE® MACINTOSH™ 128 AND 512, MACINTOSH PLUS, Ile™ AND Iic™

Finding a reliable and affordable hard disk for your Apple computer is easier than you think thanks to the new ProAPP™ 10 and 20 megabyte hard disk systems.

10MB HARD DISK SYSTEM—\$795.

20MB HARD DISK SYSTEM—\$995.

Attractively styled and priced to match, the compact ProAPP 10 and 20 are designed to work with all popular Apples. Everything you need is provided: cables, easy-to-use manuals and software. Simply plug in and run.

The ProApp 10 and 20 come ready to support the following Apples and operating systems: Macintosh 128 and 512, Macintosh Plus; Iic and Ile using ProDOS; DOS 3.3 or Pascal 1.3.

BUY DIRECT AND SAVE.

Right now, you can purchase the ProAPP 10 and 20 direct. This not only gives you the lowest possible price, but allows for faster, more responsive support.

ONE YEAR LIMITED WARRANTY.

The ProAPP 10 and 20 are rugged, reliable hard disk systems, incorporating the latest engineering advances like our SCSI interface and print spooler. That's why we can back them with a full 12-month limited warranty. And a toll-free hotline to answer any installation and operating questions you might have.

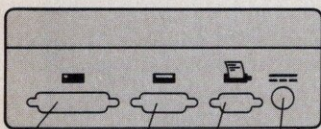

SCSI high-speed interface for Macintosh Plus.

Imagewriter compatible printer/spooler interface.

Floppy interface for Macintosh 128/512, Ile and Iic.

Connector to international power converter.

CIRCLE 175 ON READER SERVICE CARD



SOFTWARE-COMPANY BLUES

Software companies that produce entertainment software for the Macintosh are really singing the blues lately. These poor guys are being hurt from all sides. Marc Canter, president of MacroMind, tells me that Hayden Software is so many months behind on paying his company royalties for hit programs such as MusicWorks, VideoWorks, and CheapPaint that he's unable to keep up with his original plans for creating the next batch of great software and often worries how he'll be able to keep funding his current staff of only six people. And Hayden isn't the only firm that hasn't been paying its bills to software developers lately; First Software, one of the largest software distributors, is in serious financial trouble and owes a lot of money to many starting developers.

To make matters worse, Macintosh owners don't seem to be willing to part with many dollars for entertainment software. Illegal copying of programs is rampant among collegiate Mac users and others who are ordinarily a prime market for entertainment titles. When Charlie Jackson of Silicon Beach Software told me how many

copies of his company's fine Enchanted Scepters adventure game sold last month, I could have cried. And the folks at Electronic Arts tell me that the Apple II is almost always part of their plans for an entertainment product but porting games over to the Mac is a much lower priority. Has Apple finally convinced the world that the Mac really is a business computer?

CHEAPER MULTILAYER BOARDS

West-Tronics of Bensonville, Illinois, recently announced that it has developed a new method of creating multilayer printed circuit boards that cost about 16 to 20 cents per square inch for a four-layer board, which is only half what traditional boards cost. According to West-Tronics, the new boards are cheaper because the company's process eliminates a lot of the traditional etching and laminating of multilayer-board manufacturing.

Entertainment-software producers are being hurt from all sides.

SERVANT

Macintosh wizard Andy Hertzfeld is busy working on a new program tentatively called Servant that is an alternative to the Macintosh Finder. We got a sneak preview of this fascinating program when Andy demonstrated it to the Apple 32'ers users' group this spring. Servant is packed with features yet loads twice as fast as the current HFS and up to five times faster than the old MFS. Servant also permits multiple application windows to be open on the desktop simultaneously.

Andy has slightly deviated from Apple's way of doing things, which has prompted some squawks from Apple people; for example, Andy doesn't like scroll bars except for word processing, so he has chosen to use a hand to move the desktop (similar to the hand in MacPaint). Andy says that if Apple is not interested in Servant, he will find a third-party developer to market it for him.

Some of the other features in the preliminary version of Servant are the ability to assign custom-designed icons to folders or to edit other icons; the ability to use any MacPaint document as the background pattern on the desktop; a speech option that speaks the name of any icon or menu choice that you select; movement

of the actual outline of the icon when you drag it—not a simple rectangle as in the current Finder; and the ability to view the name, size, and date of files in conjunction with the full-size icons. Some neat cosmetic touches add a little flair: The hands of the watch spin while you are waiting, and the lid of the trash can flips open when you throw something away. We'll keep you posted as we find out more about Servant.

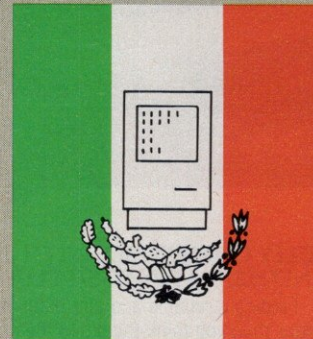

THE MAC GOES TO MEXICO

Apple de Mexico has finally received approval to sell Macs in Mexico and has announced that it is offering Spanish versions of many popular programs, from Excel to PageMaker. Apple has also created a special Apple IIe Turbo System for sale in Latin America. This system is selling well in Mexico, where Apple has an estimated 35% of the personal-computer market.

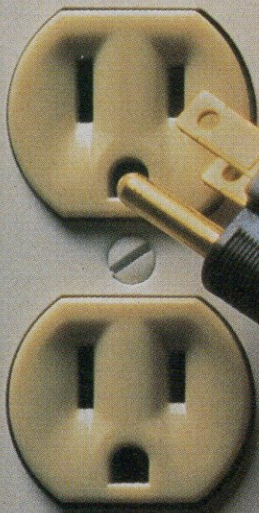

This is all it takes to get Apple talking to IBM, Tandy, Macintosh and Compaq.

And it's simple and inexpensive.

Now a powerful **GridNet™** Local Computer Communications Network is as close as your nearest electrical outlet.

Thanks to GridComm's Communicators, virtually any office can create its own high speed, error-free **GridNet™**... instantly! There's no need to purchase special system software. And there's none of the expense

and inconvenience of installing additional wiring. Because a **GridNet™** utilizes your existing electrical grid as a highly-effective data transmission medium.

And a **GridNet™** will support IBM PC, XT, AT, and all IBM compatibles, Apple and Macintosh, Hewlett-Packard, Tandy, AT&T, Epson, NEC... all the most popular micros and peripherals, in the

same network. Freely sharing data, with complete connectivity and effective compatibility.

The cost? As much as 60% below that of specially-wired systems.

Find out just how easy it is to increase your office's productivity. See your local dealer, or contact "The Great Communicator" for more information.



THE GREAT COMMUNICATOR

P.O. Box 2779, Danbury, Connecticut 06813-2779. For information call 203-790-9077

Trademarks: IBM, PC, XT, AT/International Business Machines Corp.—Apple, Macintosh/Apple Computer Inc.—Tandy/Tandy Corp.—Compaq/Compaq Computer Corp.—Hewlett-Packard/Hewlett-Packard Co.—Epson/Epson America Inc.—AT&T/American Telephone and Telegraph Co.—NEC/NEC Home Electronics (U.S.A.) Inc.

CIRCLE 199 ON READER SERVICE CARD

*So just tie my Apple Lisa
To my worn out
Appaloosa . . .*

EASTER EGGS

In my March column, I announced an *A+* Easter Egg Hunt. Easter eggs are special messages or features hidden in programs by whimsical programmers. These messages or features appear only if you take unusual actions. Here are the best Easter eggs:

From Dustin Lee Berg: Put the Congo Bongo game disk into your Apple II, turn the computer on, don't do anything until the first full screen comes on, and then press Control-A to see a bunch of otherwise hidden thank-you notes.

From Tyler Bowell of Lynden, Washington; Scott Dau of Annandale, Virginia; and Nicholas Brenckle of Hamden, Connecticut: When you get to the tactical display in the game Skyfox on the Apple II, try pressing Control-G.

Another from Tyler Bowell: To avoid having to worry about your men in Choplifter! and thereby extend your playing time, start the game by landing beside some men, on their right side, but don't let them get into the chopper; when the men get as close as they can to the chopper, take off and land about halfway across the screen. Repeat this process until you get at least one man to the base. Since this man did not board the chopper, the computer doesn't

count him as having arrived at the base, which means there are only 63 men left, but the computer thinks there are 64. This quirk will allow you to play until all your choppers are used up, without having to worry about men.

Three more from Scott Dau: Try pressing either Control-^ or Control-| during the game Hard Hat Mack for the Apple II. Pressing Control-B several times while playing Gumball on an Apple II produces interesting results.

Josh Brookhart from Hudson, Ohio, found this Easter egg in his older Ap-

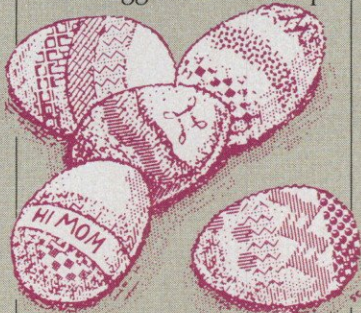

ple IIc: Type this one-line program into an Apple IIc with the old ROMs:

```
10 PR#5:IN#5:INPUT AS:PRINT AS
```

Chandid Wilson tells us that if you are not able to complete Friday on the Gumball game for the Apple II, you can see a special message on track 1F, sectors F and E.

According to George Howe of Scotia, New York, another disk location for a secret message is on track 17 (hex 11), sector

5 in The Print Shop for the Apple II.

George Deriso of Fremont, California, says that the "Stolen from Apple Computer" message hidden in the Macintosh ROM has been changed from location \$40AD26 in the original Mac to location \$40E118 in the Mac Plus.

From C. V. Rao of Houston, Texas: If you play the Airborne game on the Macintosh on Christmas (or with the Mac's calendar set to December 25), a Christmas tree appears in the field instead of a cactus.

Dan Eggleston of Austin, Texas, has a version of the Resource Editor program for the Macintosh that has a few doozies that we've unfortunately been unable to duplicate. If anyone knows which version of the Resource Editor these Easter eggs work with, write to me, and I'll let people know. Anyway, Dan claims that if you hold down the ⌘ and option keys while selecting About Resource Editor from the apple menu, a message appears that states, "Thanks for the Mrs. Field's cookies, etc.," and if you choose About Resource Editor while pressing the Shift, ⌘, and Option keys, your computer will go into "flipping pig mode," whatever that is.

Thanks, everyone, for sharing your Easter eggs!

AN APPLE SONGBOOK?

Writer and computer humorist Dr. John Bear, whom some of you may recognize as the author of the book *Computer Wimp*, read that the original IBM and NCR company songbooks had been rediscovered. Bear, musing on what the Apple Computer songbook might contain, came up with these examples for us:

(to the tune of "Battle Hymn of the Republic")

Mine eyes have seen the
story of our Wozniak
and Jobs
How they rose to fame
and glory, from their
days as nerds and slobs,
As they parlayed their
blue boxes into money
by the gobs,
And Apple rolled along.

Glory be to their endeavor,
Apple II will live forever,
Sculley, Sculley, now or
never,
As Apple rolls along.

(to the tune of "The Last Roundup")

I'm a-headin' for the last
roundup,
To that land where sales
curves rise into the sky,
So just tie my Apple Lisa
To my worn out Appa-
loosa,
And we'll all reach hacker
heaven by and by.

The Complete Works With AppleWorks™

Coming Soon:
PageWorks and ChartWorks....

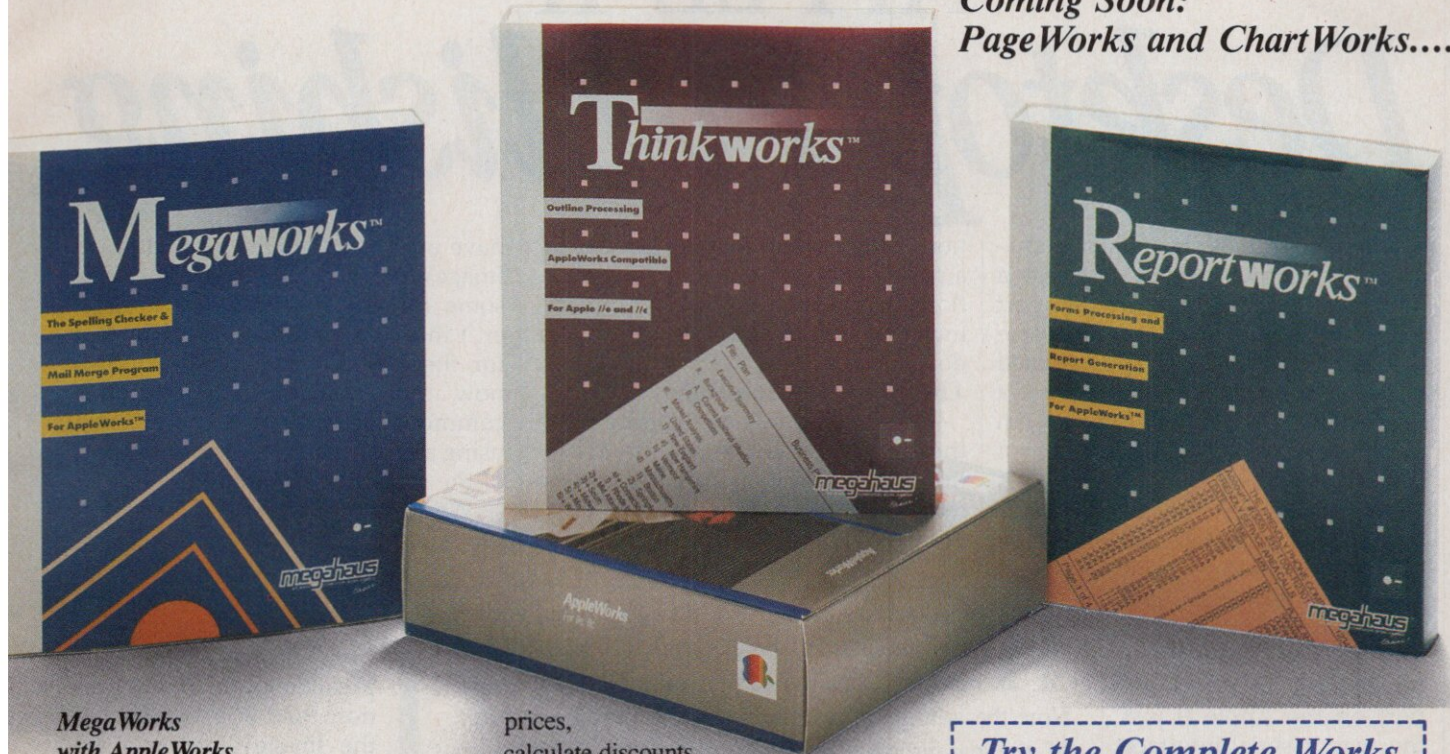

MegaWorks with AppleWorks.

MegaWorks is the Mail Merge and Spelling correction program designed exclusively for AppleWorks. MegaWorks' mail merge lets you combine information from AppleWorks database files with word processing documents to print personalized form letters. MegaWorks' spelling checker corrects misspelled words in documents and allows you to customize its 40,000 word dictionary with 10,000 more words of your own. Both mail merge and spelling correction maintain word wrapping and pagination of documents.

ReportWorks with AppleWorks.

ReportWorks is the powerful report generator that uses your AppleWorks files to print lists, fill out forms and analyze your data. In fact, ReportWorks allows you to produce just about any kind of report in any kind of format. And ReportWorks can add tax, look up

prices, calculate discounts, enter client information automatically and much, much more. Now with AppleWorks and ReportWorks you can:

- Fill out any form, including purchase orders, invoices and more
- Calculate and print estimates and proposals
- Analyze and summarize lists and other data

NOW, ThinkWorks with AppleWorks.

ThinkWorks is the powerful stand alone outline for Apple //, that also works with AppleWorks. Use ThinkWorks to organize any kind of information: lesson plans, reports, lists and proposals.

ThinkWorks is the only outline processor that allows you to combine outlines, and to include an outline inside an AppleWorks word processing document.

ReportWorks and ThinkWorks requires an Enhanced 128K Apple 11e or Apple 11c. MegaWorks requires a 128K Apple 11e or 11c. Two disk drives are strongly recommended.

Try the Complete Works for only \$10!!

...and receive a coupon worth up to
\$135.00 & your \$10 back!

To receive all 3 demo copies of MegaWorks, ReportWorks and ThinkWorks—just fill out this coupon & mail with your check, money order, M/C or Visa—or—better yet—call us at (619) 450-1230 & say...

"I want DemoWorks"

Name _____

Address _____

City/State/ZIP _____

Phone (Days) (_____) _____

\$10 check enclosed MC Visa Exp. _____

Signature _____

Megahaus Corporation, 5703 Oberlin Dr.,
San Diego, CA 92121

A

megahaus™
WE MAKE COMPUTERS WORK HARDER.

Easier!

5703 Oberlin Drive
San Diego, CA 92121
(619) 450-1230

*You can use your Apple II-series
computer to unleash the
powers of the Apple LaserWriter.*

APPLE II Desktop Publishing

The Apple LaserWriter is just that—an Apple output device, not just a Macintosh printer. Direct support from Apple Computer, Inc. for Apple II/LaserWriter connections is reputed to be on the way, but you can get a head start with some software from outside developers and a little bit of simple programming.

Of course, you can always use a LaserWriter in its daisy-wheel printer simulation mode to print out plain text from just about any Apple II application. The LaserWriter hooks right up to a serial port on the Apple II just the way a serial-interface daisy-wheel printer does, using a standard RS-232 serial cable. You set the software to talk to a Diablo 630 printer and set the Apple LaserWriter for 630 emulation, and away you go.

The LaserWriter can do much more, though. With the PostScript page-description language built in and its own powerful internal computer, the LaserWriter can take commands from the Apple II and process them into complex text and graphics drawn at 300 dots per inch over a full page.

Unfortunately, at present, PostScript is the only language that produces that kind of output on the LaserWriter, and Apple II applications don't yet normally produce PostScript output. Rather than providing PostScript-encoded descrip-

tions of the operations for producing a page image, most Apple II applications produce letters or dot patterns meant for an ImageWriter or similar dot-matrix printer.

Three Possible Solutions

Given that language gap between the II and the LaserWriter, three solutions are possible. You can try to teach the Apple II to produce PostScript, you can intercept Apple II out-

have an Epson printer instead of an ImageWriter, you probably have some translation software (a "driver") that adapts the standard output for the Epson machine. That's also how most Macintosh applications communicate with the LaserWriter, using a driver routine installed as part of the system configuration.

We won't know for sure until Apple releases such a translation product, but the evidence is that the firm has one in the works. At least under ProDOS, it should soon be possible to run an application that was created for the ImageWriter and get results that are as good or better on the laser-based machine.

Especially for the LaserWriter, however, using this type of translation software is not necessarily an optimal solution. The LaserWriter connected through this type of driver wouldn't get any more information than what the software would have provided to the ImageWriter. In effect, the LaserWriter is hobbled by the lesser powers of the ImageWriter, while both the originating program and output device have the potential to do more.

LaserWriter as Computer
Teaching the LaserWriter new tricks at the machine-language and ROM level is also a possibility, but for most of us that approach doesn't seem practical. Although the com-

Here's a laser printer test paragraph that shows you whole word breaks and full wall-to-wall microjustification of **ten fonts all at one time**. Note the automatic justification cancel on the last line of the paragraph. Professional features include an automatic initial capital, a progressive three stage microjustification, and "hanging" punctuation at the line ends. Both *italics* and **bold italics** can be freely intermingled. You can include ^{superscripts} gracefully, and print _{subscripts} with equal ease. Nothing very fancy is needed for a 51Ω resistor, or when $\pi = 3.14$. While the mixed fonts may be any shape or size, ranging from 3 point thru 20,000 point, most *Special Effects* are best used very sparingly.

Figure 1: The Apple Writer/LaserWriter Utilities package includes menu choices that let you combine up to ten fonts in the same paragraph.

put and translate it to PostScript on the fly, or you can get the LaserWriter to accept ImageWriter files.

Translating is perhaps the easiest general solution, because the techniques are well established for other types of printers. If, for example, you

puter that is embedded in the LaserWriter is a 68000-based machine with ROM, RAM, inputs, and outputs, it's not set up for user programming, and Apple has not made available any programming tools or an operating system.

If you are an experienced programmer, though, you might consider that PostScript, besides being an output language for printers, is also a complete programming language that theoretically can do anything that any other programming language can handle. With the right program, the LaserWriter can accept ImageWriter-format files, smooth out the images for the increased resolution, and print them out in laser-written form. You can also download programs to the LaserWriter and run them, using the Apple II as a terminal.

By far the the easiest way to get the Apple II talking to the LaserWriter right now is to get the Apple II to speak PostScript. Creating PostScript output is somewhat more difficult than simply creating characters and dots, but it's not all that hard.

Desktop publishing with your Apple II-series computer just requires the LaserWriter, some available software, and a little bit of simple programming.

AT LAST!

APPLE II DESKTOP PUBLISHING

Unleash the  Amazing Powers

of the 
LASERWRITER
with your **APPLE II!**

Very few people realize that the ProDOS Apple Writer 2.0 word processor running on an Apple IIc or IIe can give you superb full page graphics when



Apple Writer is used to do many things with Apple Writer that are very difficult if not outright impossible when attempted by any other program on any other computer 

You will, however, have to learn at least some of the PostScript language. You might try the *PostScript Reference Manual* or *PostScript Tutorial and Cookbook*, both from Addison-Wesley; the *A + PostScript* tutorial series (June–September 1985); or any of the growing number of PostScript books.

Once you've figured out what you want to say in PostScript, you shouldn't have much problem with the basic mechanics of getting the Apple II to say it. PostScript page descriptions consist of procedural statements in ASCII (normal text) or bit maps in hexadecimal form, both of which you can produce with the right routines in Applesoft or another programming language.

If you do go this route, remember that PostScript is a vector (drawing procedures)-based, rather than a pixel (dot pattern)-based, language. So creating an image is more like creating shape tables for screen video than it is like fiddling with bits in screen memory. Instead of telling PostScript where each dot should go, you tell it a procedure for drawing an image.

You can, if you wish, send normal Apple II hi-res pictures to the LaserWriter by using some routines in PostScript that accept bit-map pictures in hexadecimal form, but that will give you the Apple II's 192 × 280

screen resolution, rather than the 300-dot-per-inch maximum of the LaserWriter.

Furthermore, when you do get application software to produce PostScript output, you won't be able to see your creations directly on the screen, unless you also write your own PostScript-to-screen pixel converter (which, to say the least, would be a major enterprise). So you'll have



Figure 2: Lancaster's package lets you do curved and fancy text and graphics for logos and awards, and even giant text for signs.

to create most of your work as a series of iterations: writing PostScript instructions, printing the result, and then making necessary adjustments.

If you have no love for programming, on the other hand, you may just want to wait for a bit. Fairly soon, you should start to see a growing

number of programs for the Apple II that include PostScript output meant for the LaserWriter.

Lancaster's Electronic Linecaster

If you do decide to take the PostScript plunge yourself, you don't have to start completely from scratch. Don Lancaster, one of the true pioneers of the personal-computer movement, has been exploring the Apple II/LaserWriter connection, and he's put together an intriguing package called *Apple Writer/LaserWriter Utilities* that transforms the Apple Writer II word-processing program into a PostScript output package (see "Apple Writer Is an Open Road," below).

The results can be absolutely stunning. Included in the package are routines that set typeset text, routines that draw circuit diagrams, and routines that produce bumper stickers and business cards. One even draws Mickey Mouse.

Happy Hacking

At the stage that I saw them, Lancaster's routines did most of the middle half of the job—you still have to organize the basics, and Lancaster's software won't take care of the very fancy cases. It is, at least right now, intended for those of us who like to hack around: You do need to learn at least some PostScript, and many

APPLE WRITER IS AN *Open Road*

Apple Writer II may not have been designed to drive PostScript printers, but it was designed for change—in the best of the Apple II tradition it includes an open-ended "macro" feature, its own high-level programming language, and even a built-in communications feature.

The macros and the WPL language make it easy to add text strings, find selected points, and pull up various blocks of text, depending on what came before. Basically, you can have WPL perform any operation that you can do directly from the keyboard.

PostScript, felicitously, can be expressed purely in ASCII (ordinary text). So if you add in the right strings at the right places, Apple Writer can indeed speak PostScript.

The adaptation is not completely perfect, however. Because the Apple Writer WPL facility was meant for small and moderate tasks, it is hard to automate the generation of the more-

complex PostScript statements.

Furthermore, the PostScript codes are not processed by the II, only by the LaserWriter. As a result, Apple Writer can't tell you if you've made a mistake or asked for operations the LaserWriter can't carry out.

Talking Direct

On the other hand, Apple Writer can at least talk directly to the LaserWriter, so you don't have to switch back and forth to a communications program to try out your files. One of the choices on the Additional Functions menu is Connect Keyboard to Printer/Modem, which routes what normally would go out to the screen to the serial port.

For short PostScript routines, you can hook the LaserWriter up to just about any serial card, run the card's initialization program to set up a 1200- or 9600-bps link (the LaserWriter can work with either speed, but you want the faster 9600 bps),

and then switch to Apple Writer.

For longer routines, though, you'll need some kind of "handshaking" that lets the LaserWriter tell the II to pause while already sent characters are processed. The LaserWriter uses the method known variously as DC1/DC3, X-ON/X-OFF, or Ctl-S/Ctl-Q, which means it sends back the first in each character pair when it needs the Apple II to wait and the second character when it's ready for more text. Some cards, including Apple's Super Serial Interface, have such a handshaking feature built into their driver software.

At 9600 bps, Apple Writer can't really keep up a two-way conversation, so if you simply send your PostScript files to the LaserWriter without any special settings, you'll probably miss any error messages that come back during processing. You can get a free copy of how to make those settings from Don Lancaster.

Rolodex® Software

Desktop management systems from the company that started it all.

Trademark
Software

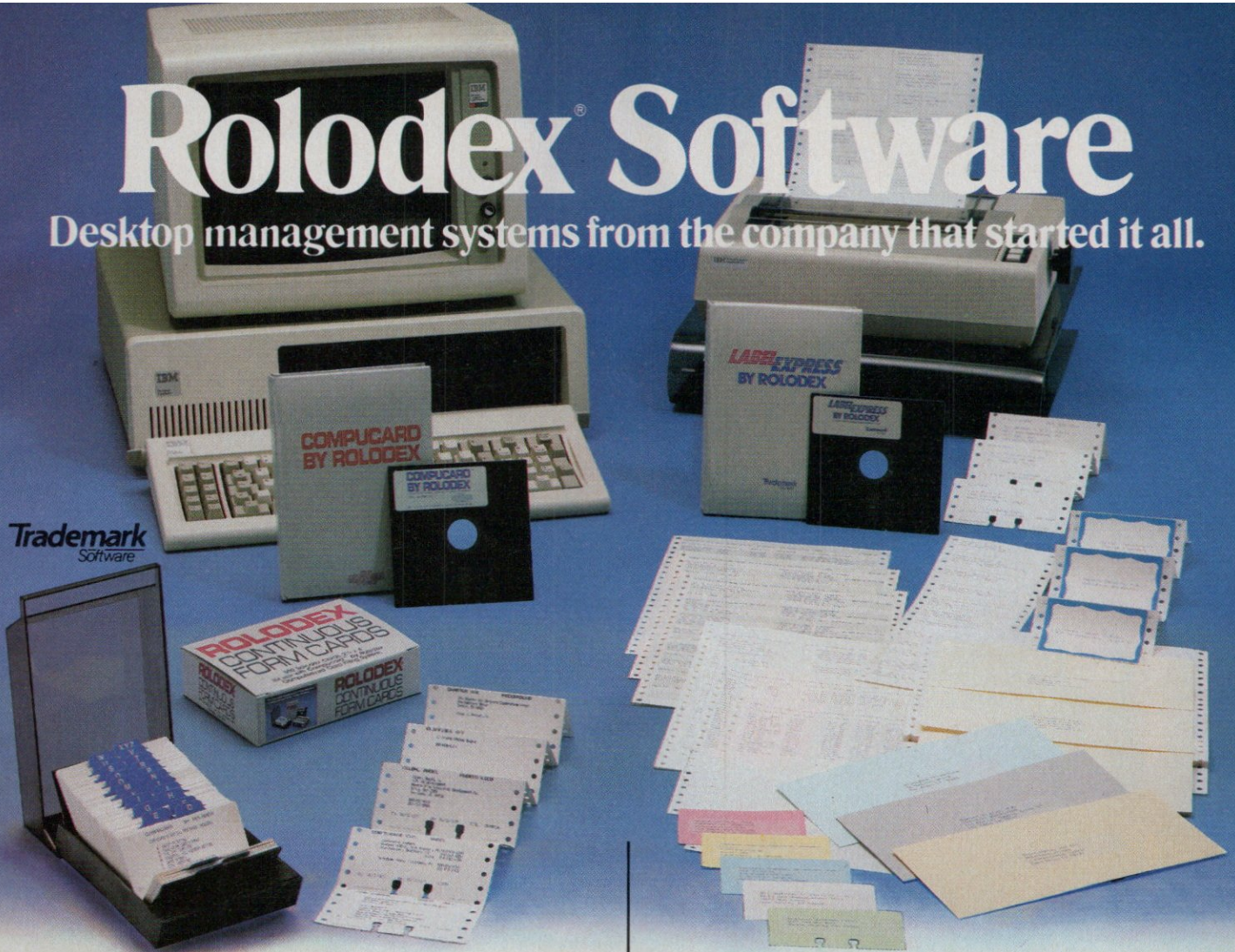

COMPUCARD BY ROLODEX™

COMPUTERIZED CARD FILING SYSTEM

With Compucard by Rolodex, card sets can be created, updated, edited and duplicated fast and easy to improve office productivity and organization as card filing is simplified.

Compucard Software Program and Documentation Manual are available for IBM®/PC (CSM-I) or Apple® IIe (CSM-A) at \$49.95. They are also available complete with VIP24C Special file and 500 Rolodex Brand Continuous Form Cards, 2 1/4 x 4" at \$68.50 (CC500-I for IBM and CC500-A for Apple). Compucard features include: Free-form card format with up to 450 characters per 2 1/4 x 4" card Rapid printing Full-screen editing commands Date stamping for each entry Dual indexing Flexible select code system.

LABEL EXPRESS BY ROLODEX™

Label and List Management Software

Label Express makes it easy to create labels, locate and update mailing lists, address envelopes, print name badges or Rolodex Brand Continuous Form Cards. Label Express by Rolodex. It keeps you in touch with people.

Label Express software is available for IBM/PC (LSM-I) and Apple IIe (LSM-A) computers, at \$49.95 each. Its powerful features include: **Creating your own label formats, up to 180 characters on five lines.** Full-screen editing with popular, word processing commands Immediate indexing for each new entry Extensive and time-saving search features Full combine/merge capability Customized printing up to 999 copies.

ROLODEX CORPORATION

245 Secaucus Road, Secaucus, N.J. 07094

An **Insilco** Company

CIRCLE 182 ON READER SERVICE CARD

IBM/PC is a registered trademark of International Business Machines Corporation; Apple IIe is a registered trademark of Apple Computer, Inc.



The data you'll have to depend on tomorrow could depend on the disk you choose today.

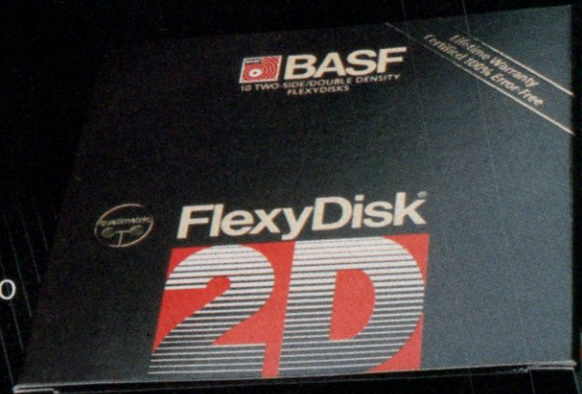

BASF QUALIMETRIC™ 5.25" FLEXYDISKS. CERTIFIED 100% ERROR-FREE AND WARRANTED FOREVER

LOOK WHAT'S IN IT FOR YOU!

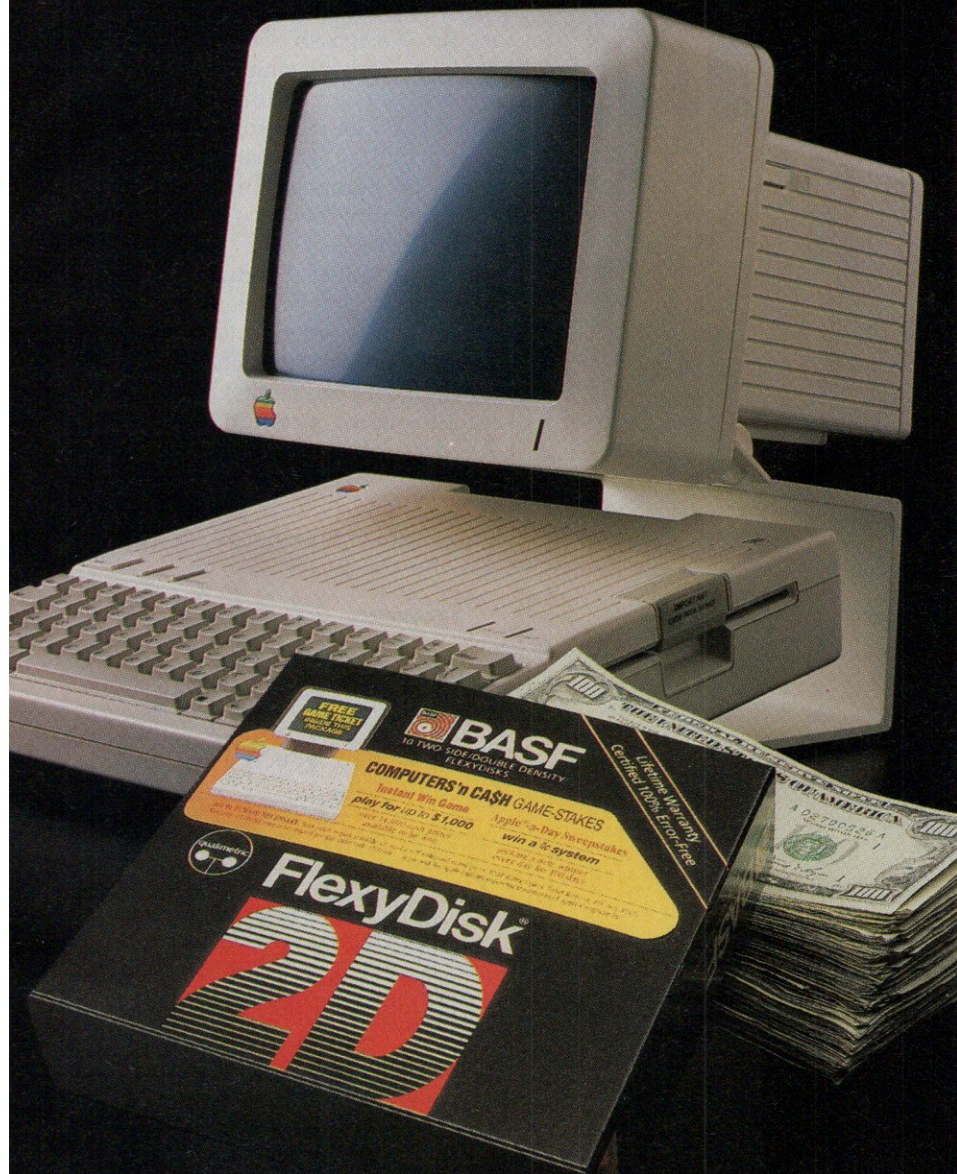

Now more than ever, there's more for you when you buy BASF Qualimetric™ FlexyDisks®. There's a special two-part game ticket that not only gives you 100 chances to win an Apple® IIc Computer in our Apple-a-Day Sweepstakes, but is also an exciting scratch-off game with 14,110 chances to instantly win cash prizes up to \$1,000. What else is in it for you? Only the best...the BASF FlexyDisk, certified 100% error-free and warranted forever. See your BASF dealer today and look for the specially-marked boxes of 5.25" and 3.5" BASF FlexyDisks.

CIRCLE 157 ON READER SERVICE CARD



Apple and the Apple logo are registered trademarks of Apple Computer, Inc.

steps require you to figure out how to customize one of the dozens of examples to perform your specific task.

But the routines are steadily evolving; you get readable, modifiable PostScript source code; the \$49.95 price is a true bargain; and Lancaster's update policy is generous: Once you buy a copy, he sends you the next update automatically and keeps doing so as long as you send back the previous update fee. He'll also answer any reasonable question about PostScript and the Apple II by phone at no charge!

Note that to try the package, you'll also need a copy of Apple Writer II (\$195, from Apple), an Apple Super Serial card or equivalent, and an RS-232 cable to hook your II up to the LaserWriter.

The Apple Writer Solution

Running the package goes like this: Using the ProDOS filer programs (from your ProDOS user disk), you make a copy of the four disks from Don Lancaster and then move a copy of your Apple Writer program to the first working disk. You boot up this combined program disk and give Apple Writer its initial opening Return.

You're now, courtesy of the Apple Writer Word Processing Language (WPL) and some programming by Lancaster, in a menu-driven system that lets you pick among a dozen or so routines on each disk, switch to any of the three other disks, or exit to Apple Writer.

Most of the routines include demonstration files that you can run by just answering a few yes/no questions, but for any serious work, you'll have to create your own text files either to combine directly with the provided routines or to send to the LaserWriter following a setup routine from the collection.

For example, the Justify menu choice leads you to a submenu with 11 different types of justification (see figure 1). One choice, the Mixed Font justify, lets you combine up to ten different fonts in the same paragraph, including a large multiline initial letter (what typographers call a drop cap). To use this routine, you enter your text as a normal Apple Writer file, with the addition of one or more of the ten possible escape codes (the ESC key followed by a number) wherever you want to change type specifications. Then, you reinvoke Lancaster's routines with the DO

NEXT MONTH...



...Ohio Kache Systems will expose you to something new and exciting.



Ohio Kache Systems Corp.
Dayton, Ohio

© Ohio Kache Systems is a developer of computer enhancement products.

command (Control-P from Apple Writer), start the justify routine, and see what the result looks like on the LaserWriter.

This routine, because it produces PostScript output directly from text rather than from an ImageWriter file, creates much finer typography than what you get from standard programs for the Macintosh. For example, it provides for placing punctuation marks at the end of lines slightly indented into the right margin ("hanging punctuation"), a feature that most simpler programs and most commercial typesetting systems do not normally give you.

Other routines produce multicolumn output, left and right justification, and even centered letters within multiple columns (which makes for attractive lists and tables). You can do step-and-repeat printing for labels, curved and fancy text for logos and awards (see figure 2), and even giant text for signs (which you paste together from individual 8½ × 11 LaserWriter sheets).

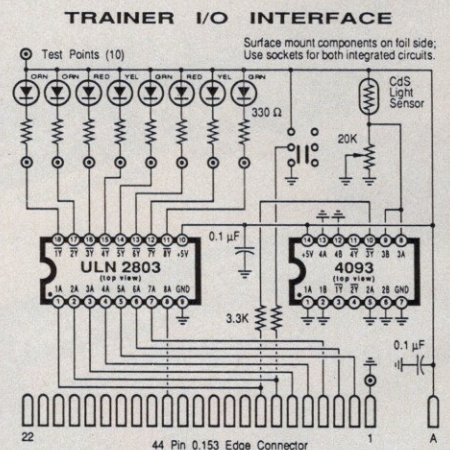

Figure 3: With a little work, you can produce drawings as complex as circuit diagrams.

If you're picture- rather than text-oriented, you'll also find many routines for both serious diagrams and some lighter work. Of necessity, these require a greater knowledge of PostScript and usually a larger number of iterations before you get them just right, but they do let you produce drawings as complex as circuit diagrams or 3-D perspective drawings, even if you can't draw a straight line (see figures 3 and 4).

For most of the graphics routines, you follow a multistep process. First, using the supplied grid routines, you print out a sheet with the markings you need to tell PostScript where to put your images. Then, using that

grid as a digitizing pad, you enter any necessary coordinates into your file. Typically, simple drawings need 20 coordinate pairs and some of the complex ones several times that. Hand-digitizing and typing in the results may seem like a rather primitive approach, but it's cheap and effective and doesn't take nearly as long as you might fear.

All curved lines in PostScript are made from a set of mathematically generated shapes called curved splines, so you'll probably need to study up on those in the PostScript manuals if you want to do any drawings that are more ambitious than

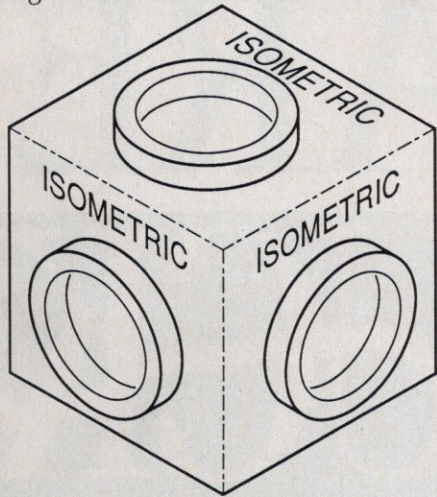

Figure 4: With the right routines, you can produce 3-D perspective drawings even if you can't draw a straight line.

straight-line diagrams. One of the routines in Lancaster's package even prints out small samples of all the shapes possible, in a small grid, to give you an idea of your choices.

Just a First Step

If you have an active imagination, you'll want to create a lot of images that you won't find in these routines. Because you get the PostScript and WPL source code, however, and because your own inputs are text as well, everything you create becomes a building block that you can use again in more complex procedures. You can save, modify, and combine your work, just as with any other Apple Writer text.

If you need to get some regular tasks done efficiently, you can simply use the same routines over and over with new text files to supply the content. Once you get the hang of WPL and PostScript, it's even relatively easy to set up your routines so less computer-knowledgeable people can use them. If you like computer games, you may find just experiment-

ing with PostScript a fascinating exercise. Think of it, perhaps, as a high-end Printed Page Construction Set.

That support for both serious business and some less-serious playfulness is what we've come to expect from Apple—and that's certainly what you'll get if you hook an Apple II and a LaserWriter together. +

Steve Rosenthal regularly posts his scripts to A+ magazine, in between his tasks as producer of the television program "The Computer Show."

PRODUCT INFORMATION

Apple Writer/LaserWriter Utilities

Don Lancaster, Synergetics
Box 809
Thatcher, AZ 85552
(602) 428-4073

List Price: \$49.95; examples of Apple II/LaserWriter output available at no charge

Requires: Apple IIe with Super Serial Card, or Apple IIc; Apple Writer II (ProDOS version)

CIRCLE 400 ON READER SERVICE CARD

Encyclopedia Electronica!

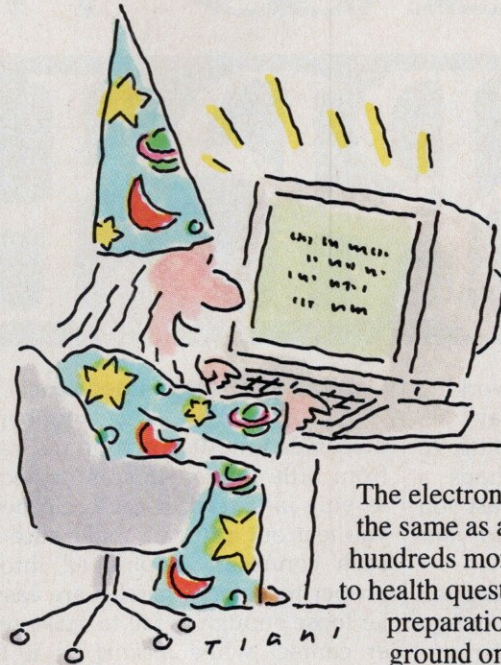

**Grolier's
Academic
American
Encyclopedia**
online through
CompuServe.

The encyclopedia that's fun to use—for the whole family.

The encyclopedia that's always current—updated every 13 weeks.

The electronic encyclopedia that costs the same as a computer game, and has hundreds more uses—from homework to health questions, from trivia to travel preparation, from business to background on new topics, from special speeches to science facts.

Subscribe Today— GO AAE on CompuServe.

Unlimited Usage for Only \$49.95 per year (Plus connect charges)

For the price of a computer game!

Also on CompuServe—GO EDU-6 to play

The Whiz Quiz*™ trivia game.



Grolier Electronic Publishing, Inc.
95 MADISON AVENUE, NEW YORK, NEW YORK 10016

*The Whiz Quiz Trademark of Grolier Electronic Publishing, Inc.

CIRCLE 169 ON READER SERVICE CARD

*Nontechnical, common-sense
remedies for
equipment malfunctions*

HARDWARE

HARD LUCK

As cooperative and hardworking as your computer may be, sooner or later it's going to throw a tantrum, perhaps a small one, but big enough to cast you back (temporarily, of course) to your old technophobic days.

When your Apple comes a cropper, you can panic and mill around or you can remind yourself that a fair number of problems are soluble with a bit of common sense, a simple tool or two, and a willingness to make the effort. Sure, some computer failures demand special tools and training to overcome them, but if your computer goes strange without filling the air with odious smells, there's a good chance that a little tinkering on your part will put things to right.

Trouble can develop in the (1) cabling and interconnections, (2) computer proper (the box with the chips and boards), (3) keyboard, (4) video monitor, (5) storage system (disk drives), and (6) peripherals (e.g., printer, plotter, modem, digitizer). In the paragraphs that follow, we'll look at some of the easy-to-cope-with difficulties that might arise.

Cabling and Interconnections

A surprisingly large number of personal-computer symptoms result from little things such as neglecting to plug in a cord or cable. So before you tear out any hair, make sure that each connector is plugged into its proper receptacle. Cables are easy to jar loose enough to fail to make proper contact while *looking* as if they were solidly attached.

Cables that you plug in and unplug frequently are susceptible to the sloppies. In time, the pins and shells get worn and loose and refuse to make a solid connection. At some point in time, you'll have to replace one or more of these plug-worn cables, although a little first aid and some care in the process of plugging and unplugging can forestall the inevitable.

The connector that's the easiest to loosen (and, hence, tighten) is the RCA phono plug on computer-to-TV video cables. The outer shell of the plug—made of a thin metal stamping—spreads because you have to wiggle it when inserting it into or removing it from its connection. Use

your fingers or a pair of pliers to *gently* press this shell back into shape (see figure 1).

The best way to manage the more elaborate connectors (commonly, DB-25s) is to attach them securely with screws or tape and leave them alone (see figure 2).

If you've determined that you do have a problem, check to see that the pins (male connector) are straight and even and that the shell makes a snug fit over the matching connector (see figure 3).

Suppose you turn on your computer one day, and the monitor comes up with nothing but a raster (a flickering white screen). You can bet that the monitor isn't getting a signal from the computer. Although there are several possible causes, the most common one is a loose or detached video cable. Check the cable at the computer end and the monitor end. If the cable just won't connect firmly, apply first aid, as discussed above. If, on the other hand, you get a completely dark screen, satisfy yourself that the monitor power cord is plugged in and the

and How to

Handle It

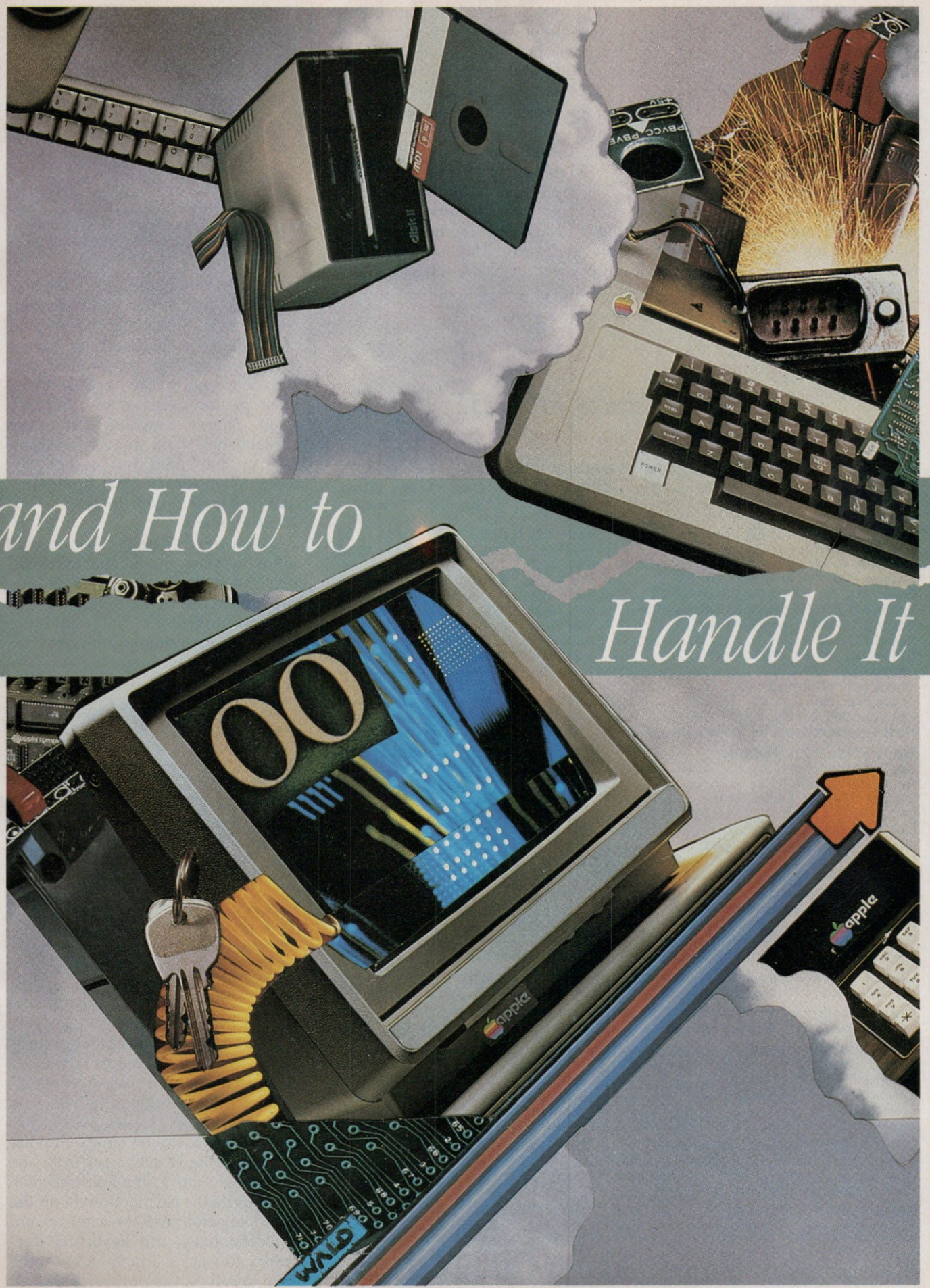

power switch is turned on.

A good strategy is to plug all your power cords into a single outlet strip, which you can use as the master switch for the whole system (see figure 4).

Invest in a good-quality strip, one with a circuit breaker, a power light, and protection against electrical "noise," which can cause your computer all kinds of aggravation. Expect to spend somewhere around \$50. It's well worth it. For ultimate protection (at ultimate cost!),

plug your outlet strip into an uninterruptible power supply. Such a doodad not only "conditions" the household electricity, but it also lets you shut down the system gracefully in the event of a brownout or black-out.

The Computer

Troubleshooting the computer itself requires more expertise than I can impart in this short article. Nevertheless, should your Apple II, II Plus, or IIe start exhibiting odd symptoms (deranged displays, refusal to accept

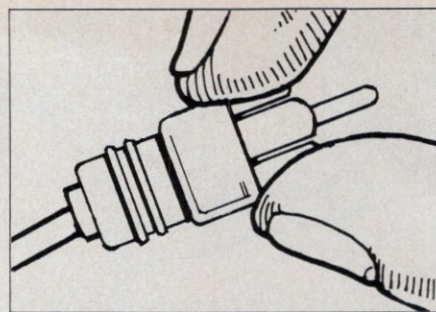

Figure 1: Using your fingers, you can press the shell of an RCA phono plug back into shape.

input, and other forms of computer dementia), turn the machine off, open the lid, disconnect the internal cables, remove the boards, and blow out (with canned compressed air) and/or vacuum up the dust balls. Then replace everything and try again. Simply reseating connectors reestablishes good contact and can clear up the flakies. For present purposes, the insides of other Apples (including Macs) are off-limits.

The Keyboard

If you haven't been conscientious about keeping the keyboard clean, keys can stick or even refuse to produce characters. A thorough application of canned air, followed by a thorough vacuuming, may be the

Ribbon Land

Quality Products for Le\$\$

ORDER HOTLINE 1-800-221-4892

In NJ or for Information CALL 201-842-1437

Nylon Ribbons - Red, Blue, Yellow, Green, Brown, & Purple. *Silver, Orange & Gold.

Printer Types	Black		Color		*Transfer	
	EACH	6+	EACH	6+	EACH	4+
*Apple Imagewriter, DMP, Prowriter	4.50	4.00	5.50	4.50	6.50	6.00
Apple Imagewriter II (Reloads)			8.00	7.50	14.00	13.00
Canon A-40/50/55, PW-1080A/1088/1156	6.00	5.50	7.00	6.50		
Comrex 220, Axiom GP550, GP700	5.00	4.50	6.00	5.50		
*Epson MX, FX, RX 80/85, Citizen 10/20	4.50	4.00	5.50	4.50	6.50	6.00
Epson MX, FX, RX 100/185, Citizen 15/25	6.00	5.50	7.00	6.50		
Epson LX-80/90, Homewriter 10	5.00	4.50	6.00	5.50	7.00	6.50
Epson LQ1500	5.50	5.00	6.00	5.50		
*Okidata 82, 92, 83, & 93/SG10	2.50	2.10	4.00	3.50	5.00	4.50
Okidata 182, 192 & 193	7.00	6.50				
Okimate 20 (Thermal)	6.00	5.50	7.00	6.50		
Panasonic 1090, 91 & 92	9.00	8.50	10.00	9.50		
Toshiba 1350, 51, P1340, P351, 341	6.00	5.50	7.00	6.50		

*Heat Transfers Available in Red, Blue, Yellow & Black.

Multi-Strike Film Ribbons

	EACH	6+
Apple Scribe (Black)	5.50	5.00
Apple LQP, Qume IV	5.25	5.00
Brother HR15/35, COMREX II	6.00	5.50
Diablo 620	4.50	4.25
Diablo Hi-Type II	3.50	3.25
Juki 6000, Juki 6100	4.00	3.75
NEC 3500	6.25	6.00
Spirit 80, BMC-80, Legend 880, 808, 1080, 1380	6.25	6.00

MacInker - Re-Ink Ribbons for about 5¢.

Apple Imagewriter, DMP, Prowriter	49.95
Epson MX, FX, RX 70/80/100	49.95
Universal Base Plus Driver Kit for Most Nylon Ribbons	64.95
Ink Kit (Available in Red, Blue, Yellow, Green, Brown, Purple & Black)	8.00

Color Computer Paper - Red, Blue, Gold, Light Blue, Pink & Ivory.

100 Sheets	\$6.00	600 Sheets or Rainbow Pack	\$24.00
------------	--------	----------------------------	---------

Color Envelopes - Invitation Size/Red, Blue, Gold, Light Blue & Pink

25 Envelopes	\$2.50	50 Envelopes	\$4.50	100 Envelopes	\$8.00
--------------	--------	--------------	--------	---------------	--------

Print Head Cleaning Kits - Helps prolong ribbon & Print Head Life.

Apple Imagewriter I & II, DMP, Prowriter	8.00
Epson MX, FX, RX 70/80/85	8.00
Epson MX, FX, RX 100/185	10.00
Epson LX-80/90	10.00
Okidata 82, 83, 92 & 93, SG10	5.00

Color Printing Software Specials - Imagewriter I & II plus More

Color Print - Print MacPaint & MacDraw files in color on the Macintosh	\$25.00
Color Chart - Print over 100 charts and graphs in color on the Macintosh	\$32.00
Prince - Color printing for IIc, IIe, II+	\$39.00

CALL FOR PRICING ON ALL HARD TO FIND RIBBONS!

School & Business Purchase Orders Accepted. Dealer Inquiries Welcome! Dealer Price List on Request. NJ Resident add 6% Sales Tax • Add \$3 Shipping & Handling for all orders under \$50 and paper orders, UPS GROUND Only.

Ribbon Land • P.O. Box 8634 • Dept. AP7 • Red Bank • NJ • 07701

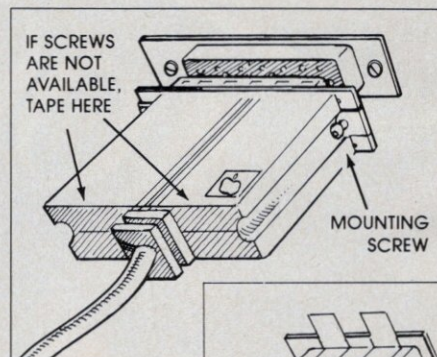

Figure 2: Secure the more elaborate connectors such as DB-25s with screws or tape.

only necessary treatment.

If some keys persist in their recalcitrance, you can try removing the cap from each offending key and spraying the inner workings lightly with electrical contact cleaner, sold at Radio Shack and similar stores. Pop the cap by prying it gently up from the front edge with a small screwdriver. Then spritz the cleaner down into the naked key and press the cap back on.

Occasionally, the keyboard electronics go wacko. Tough luck—you'll have to call on the professionals.

It speaks for itself.

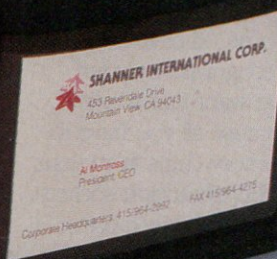
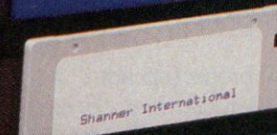
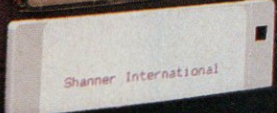

The Shanner Planner™ gives you and comes with:

- Storage for four disks - 3½" or 5¼" (specify preference when ordering)
- 5 x 8" Notepad - can also accommodate documentation up to 300 pages
- Pen and Pencil Compartment
- Ruler Slot
- Business Card Section
- 5 Year Calendar
- Full Function Memory Calculator

The unique velcro locking system ensures that your important media and contents are safely secured in their compartments at all times.

Measuring approximately the size of a normal executive portfolio, The Shanner Planner will fit comfortably into any size attache or carrying case, and comes packaged in an attractive gift giving box.

The Shanner Planner™

\$39⁹⁵

Dealer Inquiries Accepted
Call 800/828-6637

Remember the expression "A picture is worth a thousand words?" Take a second look. The Shanner Planner™ is the first ever full system portfolio created specifically for the computer user. Designed to address the individual needs of the computer industry, The Shanner Planner is tastefully constructed of long lasting, durable, textured nylon (*it's the in thing today*) to maintain its smart appearance over time.



SHANNER INTERNATIONAL CORP.
The Shanner Planner™ is a creation of, marketed worldwide by, and is a Trademark of SHANNER INTERNATIONAL CORP.
CIRCLE 116 ON READER SERVICE CARD

See the local authorized dealer nearest you or use this *SPEEDY* order form.

Please send me _____ Shanner Planner(s) at \$39.95 each, plus \$6.00 postage & handling. (CA residents add \$2.60 per Planner for sales tax.) Please indicate method of payment and media size required:

Check Money Order VISA Mastercharge Media Size 3½" 5¼"

Orders may be sent to:
Shanner International Corp.
453 Ravendale Drive, Mountain View, CA 94043

Account No. _____
Name _____
Address _____
City _____ State _____ Zip _____

Prices subject to change without notice. A+7/86
For direct orders:
Call our **HOTLINE 1-800-423-8673**. In CA **1-800-626-9273**.

RamWorks II[®]

The Best Selling, Most Compatible, Most Recommended, Most Expandable Card Available.

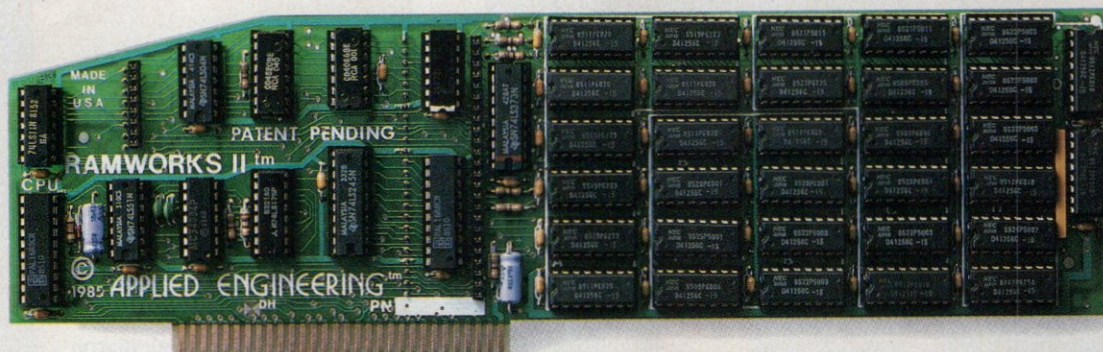

64K to 16 MEG! RamWorks II Is Number One.

It's simple, RamWorks II sells the most because it does the most.

The AppleWorks Amplifier.

While RamWorks II is recognized by all memory intensive programs, NO other expansion card comes close to offering the multitude of enhancements to AppleWorks that RamWorks II does. Naturally, you'd expect RamWorks II to expand the available desktop, after all Applied Engineering was a year ahead of everyone else *including Apple* in offering more than 55K, and we still provide the largest AppleWorks desktops available. But a larger desktop is just part of the story. Look at all the AppleWorks enhancements that even Apple's own card does not provide and *only* RamWorks II does. With a 256K or larger RamWorks II, *all* of AppleWorks (including printer routines) will automatically load itself into RAM dramatically increasing speed by eliminating the time required to access the program disk drive. Switch from word processing to spreadsheet to database at the speed of light with no wear on disk drives.

Only RamWorks II eliminates AppleWorks' internal memory limits, increasing the maximum number of records available from 1,350 to over 15,000. *Only* RamWorks II increases the number of lines permitted in the word processing mode from 2,250 to over 15,000. And *only* RamWorks II (256K or larger) offers a built-in printer buffer, so you won't have to wait for your printer to stop before returning to AppleWorks. Ram-

Works II even expands the clipboard. And auto segments large files so they can be saved on two or more disks.

RamWorks II, nothing comes close to enhancing AppleWorks so much.

The Most Friendly, Most Compatible Card Available.

Using RamWorks II couldn't be easier because it's compatible with more off-the-shelf software than any other RAM card. Popular programs like AppleWorks, Pinpoint, Catalyst, MouseDesk, HowardSoft, FlashCalc, The Spread Sheet, Managing Your Money, SuperCalc 3a, and MagiCalc to name a few (and *all* hardware add on's like ProFile and Sider hard disks). RamWorks II is even compatible with software written for Apple cards. But unlike other cards, RamWorks II plugs into the Iie auxiliary slot providing our super sharp 80 column text in a completely integrated system while leaving expansion slots 1 through 7 available for other peripheral cards.

Highest Memory Expansion.

Applied Engineering has always offered the largest memory for the Iie and RamWorks II continues that tradition by expanding to 1 full MEG on the main card using standard RAMs, more than most will ever need (1 meg is about 500 pages of text)...but if you do ever need more than 1 MEG, RamWorks II has the widest selection of expander cards available. Additional 512K, 2 MEG, or 16 MEG cards just snap directly onto RamWorks II by plugging into the

industry's only low profile (no slot 1 interference) fully decoded memory expansion connector. You can also choose non-volatile, power independent expanders allowing permanent storage for over 20 years.

It Even Corrects Mistakes.

If you've got some other RAM card that's not being recognized by your programs, and you want RamWorks II, you're in luck. Because all you have to do is plug the memory chips from your current card into the expansion sockets on RamWorks II to recapture most of your investment!

The Ultimate in RGB Color.

RGB color is an option on RamWorks II and with good reason. Some others combine RGB output with their memory cards, but that's unfair for those who don't need RGB *and* for those that do. Because if you *don't* need RGB Applied Engineering doesn't make you buy it, but if you want RGB output you're in for a nice surprise because the RamWorks II RGB option offers better color graphics plus a more readable 80 column text (that blows away any composite color monitor). For only \$129 it can be added to RamWorks II, giving you a razor sharp, vivid brilliance that most claim is the best they have ever seen. You'll also appreciate the multiple text colors (others only have green) that come standard. But the RamWorks II RGB option is more than just the ultimate in color output because unlike others, it's fully

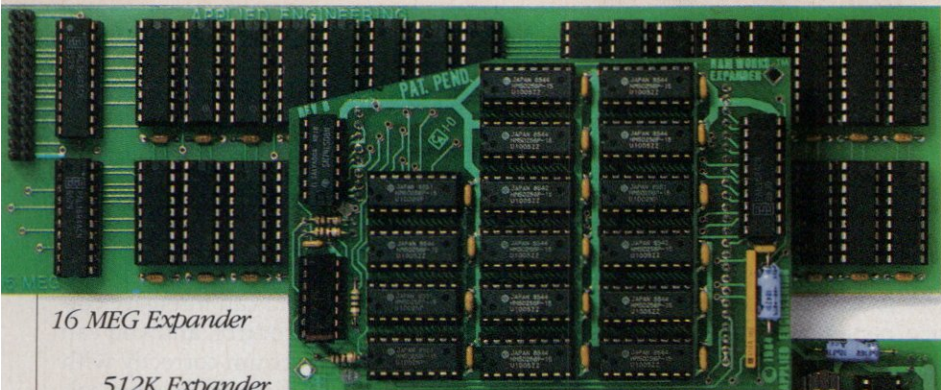

16 MEG Expander

512K Expander

compatible with all the Apple standards for RGB output control, making it more compatible with off-the-shelf software. With its FCC certified design, you can use almost any RGB monitor because only the new RamWorks II RGB option provides both Apple standard and IBM standard RGB outputs (cables included). The RGB option plugs into the back of RamWorks II with no slot 1 interference (works on the original RamWorks, too) and remember you can order the RGB option with your RamWorks II or add it on at a later date.

True 65C816 16 Bit Power.

RamWorks II has a built-in 65C816 CPU port for direct connection to our optional 65C816 card. The only one capable of linearly addressing more than 1 meg of memory for power applications like running the Lotus 1-2-3™ compatible program, VIP Professional. Our 65C816 card does not use another slot but replaces the 65C02 yet maintains full 8 bit compatibility.

Endorsed by the Experts.

Steve Wozniak, creator of the Apple Computer said "I wanted a memory card for my Apple that was fast, easy to use, and very compatible; so I bought RamWorks." A+ magazine said "Applied Engineering's RamWorks is a boon to those who must use large files with AppleWorks...I like the product so much that I am buying one for my own system." inCider magazine said "RamWorks II is the most powerful auxiliary slot memory card available for your Iie, and I rate it four stars...For my money, Applied Engineering's RamWorks II is king of the hill."

Apple experts everywhere are impressed by RamWorks II's expandability, versatility, ease of use, and the sheer power and speed that it adds to any Iie. With a RamWorks II in your Apple, you'll make IBM PC's and AT's look like slowpokes.

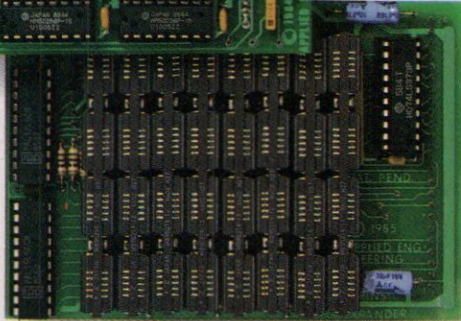

2 Meg Expander

It's Got It All

- 15 day money back guarantee
- 5 year hassle free warranty insures coverage no matter where you purchase
- Built-in super sharp 80 column display, (with or without RGB)
- Expandable to 1 MEG on main card
- Expandable to 16 meg with expander card, with NO slot 1 interference
- Can use 64K or 256K RAMs
- Powerful linear addressing 16 bit coprocessor port
- Automatic AppleWorks expansion up to 3017K desktop
- Accelerates AppleWorks
- Built-in AppleWorks printer buffer
- The only large RAM card that's 100% compatible with all Iie software

RGB Option

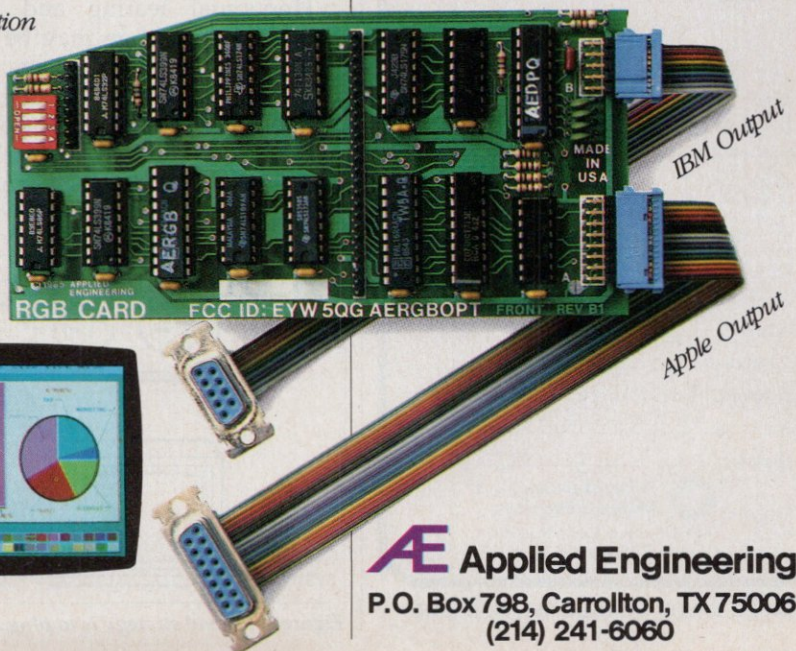

- RamDrive™ the ultimate disk emulation software included free
- Memory is easily partitioned allowing many programs to be in memory at once
- Compatible, RGB option featuring ultra high resolution color graphics and multiple text colors, with cables for both Apple and IBM type monitors
- Built-in self diagnostics software
- Lowest power consumption (patent pending)
- Takes only one slot (auxiliary) even when fully expanded
- Software industry standard
- Advanced Computer Aided Design
- Used by Apple Computer, Steve Wozniak and virtually all software companies
- Displays date and time on the AppleWorks screen with any PRO-DOS compatible clock
- Much, much more!

RamWorks II with 64K	\$179
RamWorks II with 256K	\$219
RamWorks II with 512K	\$269
RamWorks II with 1 MEG	\$369
RamWorks II with 1.5 MEG	\$539
RamWorks II with 3 to 16 MEG	CALL
65C816 16 Bit Card	\$159
RGB Option	\$129
256K Upgrade	\$ 50

RamWorks II. The industry standard for memory expansion of the Apple Iie. ORDER YOUR RamWorks II TODAY. 9 a.m. to 11 p.m. 7 days, or send check or money order to Applied Engineering. MasterCard, Visa and C.O.D. welcome. Texas residents add 5½% sales tax. Add \$10.00 if outside U.S.A.

AE Applied Engineering
 P.O. Box 798, Carrollton, TX 75006
 (214) 241-6060

YOUR
APPLE
TODAY,
KEEPS THE
DOCTOR
AWAY.



HOUSECALL

THE COMPUTERIZED
HOME MEDICAL ADVISOR

- Written By Physicians.
- Over 400 Diagnoses.
- Concise Information accessed directly or through branching questionnaire.
- Educational—background and treatment for each condition diagnosed.
- Closely Related Diagnoses follow computer's initial choice.
- A Ready "Second Opinion".
- Fast, Easy and Fun to use.
- Self Contained—Multiple disk data base—no modem needed.
- Always Current—yearly updates available at nominal cost.

Great For Business Offices As An Employee Benefit. Also Helps Reduce Absenteeism

HOUSECALL Will Run On APPLE II +, c, e, IBM PC Family, and 100% Compatibles. Dealer inquiries invited.



To Order Call Toll Free
(800) 233-3556
For More Information Call
(303) 773-1237

List Price \$79.95 **SPECIAL \$49.95**

Please send _____ copies of **HOUSECALL**
@ \$49.95 + \$5.00 shipping (\$12.00 foreign).
[Colorado residents add \$1.80 tax]. 20 Day Money
Back Guarantee. For Unprotected Add \$20.00.

Type of Computer _____

Name _____

Address _____

City/State/Zip _____

Check VISA MC Exp. Date _____

No. _____

Signature _____

**Rocky Mountain
Medical Software, Inc.**
5680 S. Syracuse Circle, Suite 500A
Greenwood Village, CO 80111

CIRCLE 239 ON READER SERVICE CARD

The Display Monitor

Most monochrome monitors have readily accessible controls for brightness (or "black level") and contrast, as well as horizontal and vertical hold. Some also allow you to adjust picture height and width. Next time you turn on your computer, experiment with these controls and note how each one affects the display. Service personnel report that an unexpectedly large number of home computerists bring in computers that are "malfunctioning," only to find out that someone has inadvertently twitched one or more of the display

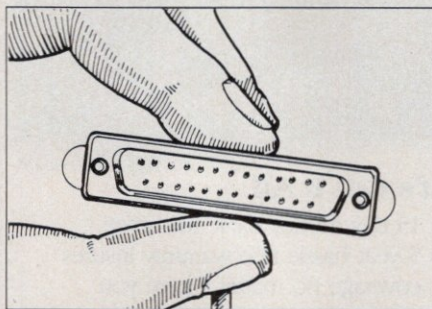

Figure 3: Make sure the male DB-25 connector's pins are straight and even.

controls enough to distort or even wipe out the picture.

The ideal brightness and contrast settings are those that give you a sharp display from your normal viewing distance. Cranking up the brightness smears the image, shortens the life of the picture tube, and gives you a headache. Ditto for contrast. Play with the two controls until you arrive at the sharpest, clearest image at the lowest comfortable viewing intensity.

Horizontal tearing and vertical rolling of the image may be due to various electronic problems in the computer or monitor, but give the horizontal and vertical controls a try. As components age, their electrical values change somewhat, and occa-

sionally you need to compensate by fine-tuning things. You can almost always settle the screen down with some judicious knob twisting.

To the preceding problems, color monitors add those problems that are associated with color saturation (intensity), color accuracy (tint), and color purity and alignment. You can intensify color with the color control, and you can distribute the spectrum correctly with the tint control. You have to leave color alignment (including purity adjustment) to a trained technician, however, who has to open the monitor and do a lot of fiddling around inside—a fairly expensive process.

Unless you've had your monitor or color TV set for a long time, it's unlikely to need alignment. Generally, tinkering with the various image controls (brightness, contrast, color, and tint) should do the job. If you've made a reasonable effort and the display still looks dismal, the TV- or computer-service center is in for some profit at your expense.

Remember that, dollar for dollar, a monochrome monitor gives you a sharper image than a color monitor does. A color TV set used as a monitor gives you the poorest image of all. No matter how much you touch up the controls, you can't overcome the TV's inherent limitations.

Monitors, along with the rest of your equipment, like to be clean. So every few days, wipe the screen off with a *slightly* damp sponge and quickly dry it, and don't allow dust (or anything else) to clog the ventilation slots. Heat and electronic components are natural enemies.

Disk Drives

Service people report that disk drives fail more frequently than any other computer component. Despite this seemingly horrifying statistic, disk drives are pretty reliable. Here

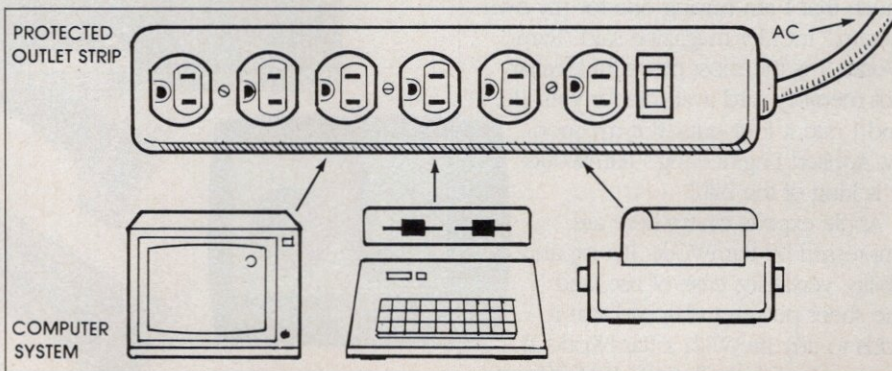

Figure 4: A good strategy is to plug all of your power cords into a protected outlet strip.

are a few hints anyway.

If you have trouble getting a disk to boot, the problem may be with (1) the disk itself (try another copy of the same program or another program); (2) an errant data bit in the system (turn off the computer for a few seconds, remount the disk, close the drive door tightly, and reboot); (3) dirty read/write head(s); or (4) incorrect spin rate. Actually, there can be many other causes, but these are the most common.

You can clean the heads with a commercial head-cleaning kit. Just don't overdo it, or you'll cause premature head wear. To determine if timing really is the cause of your grief, you'll need a diagnostic disk. Retiming requires that you get to the innards of the drive, and the manual that comes with the diagnostic disk should tell you how to do this.

Handle disks carefully, replacing them in their envelopes as soon as you're finished with them, and never leave disks sitting in disk drives when you've closed up shop.

For an in-depth look at do-it-yourself disk-drive repair, dig out your March and April 1985 issues of *A+*, which include a two-part series called "First Aid for Disk Drives."

The Printer

Paper jams, paper dust, and blown dot-matrix printheads constitute the major ills your printer is heir to. Printers with easily accessible configuration switches are also prone to sudden failures due to little fingers' fiddling with little switches. Before doing anything else, check to see that all the switches are properly set. You should have made records of the settings when the printer was installed.

Paper jams usually result from improperly seating the tractor holes on the tractor pins, oblique feeding of continuous forms with a friction-feed printer, or anything that hinders the movement of paper. Hindrances may arise from improper paper loading, small scraps of paper in the paper path, allowing already printed pages to feed back through with new paper (it happens!), and objects sitting on the paper on its way to the printer.

Paper produces a large quantity of fibrous dust that can eventually cause your printer to misbehave. Preventive maintenance pays. Carefully clean out your printer about once a month. Use canned compressed air to dislodge the fibers and a vacuum



Capture \$500 in Savings Expand your System with Orange Micro's Rebate Bonanza

Orange Micro has already helped to expand over 350,000 Apple II systems with the revolutionary Grappler+ printer interface series. This summer, we are launching the **Rebate Bonanza**. Teamed with leading manufacturers, we'll provide you with over \$500 worth of valuable coupons good for cash rebates and free merchandise on the most popular software and accessories for your Apple II. Exciting products from BPI, Broderbund, Data Transforms, Kensington, Koala, Orange Micro, Manzanita, Megahaus, Pinpoint, Quark, Roger Wagner and Sir-tech. All this, just for expanding your system with the most popular line of Apple enhancements in history.

Orange Micro — The Best Choice

From simple text to the most complex graphics, Orange Micro has the best solution for your Apple II. For IIe and II+ users, the Grappler+ offers the industry standard with over 30 built-in features for unparalleled versatility in graphics and text. The Buffered Grappler+ merges Grappler print versatility with up to 20 pages of buffering to save you time. For text formatting exclusively, the Orange Interface™ offers intelligence for about the price of a "dumb" interface. And, the Serial Grappler+ provides exclusive color Grappler capabilities for ImageWriter II users.

If you own a IIc, Orange Micro again has the answers. For an effective and economical link to any parallel printer, the HotLink is what you need. For

advanced graphics, the Grappler C is the most powerful IIc parallel interface available.

\$10 Cash Rebate on the new ImageBuffer

Orange Micro has developed a revolutionary enhancement for Apple's ImageWriter II printer — the ImageBuffer. The ImageBuffer offers the most powerful print buffer available (up to 128K — 40 pages of text!) as well as the ability to make over 250 copies of any original. Snapping easily into the expansion port of the ImageWriter II, the ImageBuffer requires no power supplies or extra cables. Best of all, Orange Micro has included a \$10 cash rebate coupon for the ImageBuffer in the **Rebate Bonanza**. That makes the ImageBuffer the best value available anywhere.

The Time is Now!

Orange Micro's **Rebate Bonanza** is on for a limited time only, so don't delay. Look for the specially marked packages or ask your Orange Micro dealer for details. Orange Micro products plus a \$500 **Rebate Bonanza** to help expand your system. There's never been a better time to make the best choice in printer interfacing... ORANGE MICRO.



1400 N. Lakeview Ave., Anaheim, CA 92807
(714) 779-2772

©Orange Micro, Inc. 1986

CIRCLE 258 ON READER SERVICE CARD

HOW TO TURN YOUR APPLE® INTO A BANKER.

Here's how to make the investment in your Apple really pay off.

With SPECTRUMSM the electronic home banking and information system from The Chase Manhattan Bank, N.A. Teamed up with your PC, SPECTRUM is your direct link to Chase. And the start of a better way to manage your money and your time.

A push of a button lets you pay bills electronically, anywhere; transfer funds; keep records; and more. Even get vital financial information and trade stocks* at discount rates.

Right at home, anytime—with complete security. All, including electronic mail, starting at just \$5 a month. And, with 2 months free for new subscribers, now's an even better time to get control of your finances. Call today for your free demo diskette.

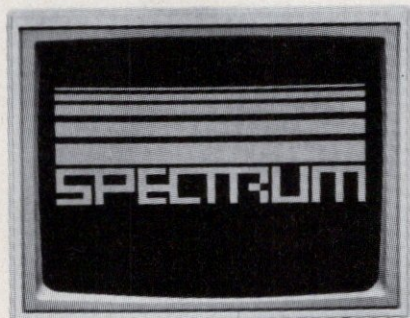

**CALL TOLL FREE
1-800-522-7766**



© 1986 The Chase Manhattan Bank, N.A. / Member FDIC.

Apple is a trademark of Apple Computer, Inc.

*Stocks are traded through Rose & Company Investment Brokers, Inc., a Chase affiliate/Member NYSE and SIPC.

The moral of the story: Maintenance is better than repair. Keep your computer equipment clean, dry, and well connected. Don't let familiarity breed contempt.

cleaner to get rid of them. After the unit is clean, wipe a *thin* coat of high-quality lubricant (such as a Teflon-based oil) onto the rail that carries the printhead.

A blown dot-matrix printhead either refuses to print anything or prints only some of the dots. The result of one or more missing dots is fine blank lines across the printed page. All the popular dot-matrix printers come with user-replaceable printheads, and you'll save a service charge by doing the simple replacement yourself. Order the correct head from the dealer, remove the old head, and mount the new one. Removal generally amounts to no more than taking out two screws and unplugging a small cable. Replacement reverses the process and is just as easy. While you're at it, clean off the printhead rail and wipe on a little bit of lubricant.

The Moral of the Story

Maintenance is better than repair. Keep your equipment clean, dry, and well connected. Don't let familiarity breed contempt. And when disaster strikes, don't panic. Yell, but don't panic. Then sit down and let your sense of logic and order tell you where the problem lies. If you feel you can handle it yourself, give it a try. Otherwise, pack the computer off to the service center. Of course, you must *never* do anything to your computer while it's still under warranty! Let Apple Computer worry about it in that case. +

Henry Beechhold is a professor of English and linguistics at Trenton State College in Trenton, New Jersey. He is the author of Plain English Repair and Maintenance for Home Computers (Simon & Schuster) and is product review editor of Computer Consultant.

The Universal MacInker(s)TM are here

**Re-ink any Fabric
ribbon automatically
for less than**

5¢

Now one **Universal Cartridge MacInker (UC)** re-inks all fabric cartridges and one **Universal Spool MacInker (US)** re-inks all spools. We have **MacInker(s)** dedicated to specialized cartridges, zip pack, harmonica etc. Over 1000 printer brands supported. Use your **MacInker** to re-ink your dry, fabric cartridges (for less than 5 cents in ink) and watch the improvement in print-out quality. Our new, residue-less, lubricated, dot matrix ink yields a darker print than most new ribbons. Or get any of our basic ink colors: brown, blue, red, green, yellow, purple and use **MacInker** to create and/or Re-ink your own colored cartridges. We have uninked or colored cartridges for the popular printers and ribbon re-loads for any printer. Operation is extremely simple & automatic with new, twin drive electric motor that supports CW and CCW rotating cartridges. A good quality fabric ribbon of average length can be re-inked almost indefinitely. In our tests one re-inked Epson* 80 ribbon has outlived the estimated life of the print-head!! We receive consistent & similar feedback from our customers. As of August 85 we have over 40,000 MAC INKER(s) in the field, in 5 continents (220 V motors available). **MacInker (UC) is \$60.00.** Cartridge drivers are **\$8.50/ea.** We still have our first generation, dedicated **MacInker(s)** for most popular printers. Prices start at **\$48.00** with most units below \$60.00. **MacInker** has been reviewed, approved and flattered in most magazines and even in the NEW YORK TIMES and the CHICAGO SUN TIMES.

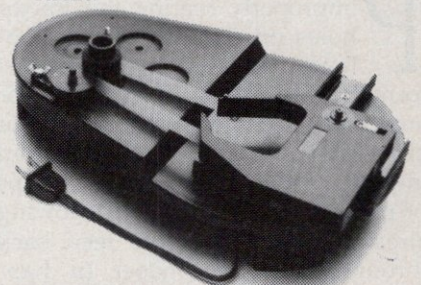

Computer Friends

6415 S.W. Canyon Ct.
Portland, OR 97221
(503) 297-2321

Order toll free 1-800-547-3303
or ask for free detailed brochure.
Dealers inquiries welcome.

*EPSON is a trademark of EPSON CORP.

MultiScribe™

Creative Writing for Your Apple® IIc™/IIe™

Now your Apple IIc or IIe can offer you the type of creativity that you might have thought was available only with a Macintosh.™ MultiScribe is a full feature word processor that uses double hi-res and proportional spacing to give your Apple all the character of a Mac.

You supply the imagination, MultiScribe does the rest.

There are no complicated commands to learn. Easy to use pull-down menus provide you with a wide range of type styles, character sizes, and text formatting options. You can choose the typeface that's right for your text—or create your own custom fonts with MultiScribe's font editor. And MultiScribe gives your writing style—any style, from bold and underline to italic, outline and shadow—just like MacWrite.™

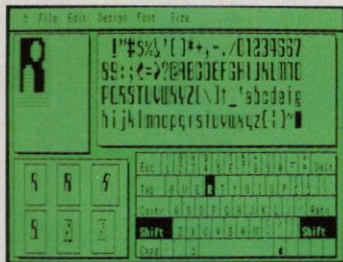

Pictured above: MultiScribe's font editor.



If you're afraid of mice, don't worry.

With MultiScribe, you have the option of using a standard keyboard or a mouse. Use your mouse to pick and click commands from the pull-down menus... or use the arrow keys for "keyboard mouse" action. Each MultiScribe option has a keyboard equivalent displayed right on the menu, giving you the best of both worlds.

Don't upgrade your old computer, just your old files.

MultiScribe works with any IIc or IIe equipped with extended 80 column card and most dot-matrix printers, including Imagewriter,™ Epson,® and Okidata.® You can even use MultiScribe to customize files created by other word processing programs.

And best of all—the price.

MultiScribe is available for only \$59.95. Just complete and mail the coupon below or call our toll-free number, 1-800-233-4088 (in Texas call 1-713-771-4627).

\$59.95

+ \$3.00 shipping & handling
 Texas residents add 5 1/8% sales tax.
 Outside U.S. add \$10.00.
 Make check or bank order payable to:
StyleWare, Inc.

Name		
Street		
City	State	Zip
<input type="checkbox"/> MasterCard®	<input type="checkbox"/> Visa	<input type="checkbox"/> Check/Money Order
Card#	Exp. Date	
<input type="checkbox"/> 5 1/4" Diskette	<input type="checkbox"/> 3 1/2" Diskette	
MultiScribe™ Creativity at your fingertips. StyleWare, Inc. 6405 Hillcroft, Suite 201, Houston, Texas 77081		

CIRCLE 155 ON READER SERVICE CARD

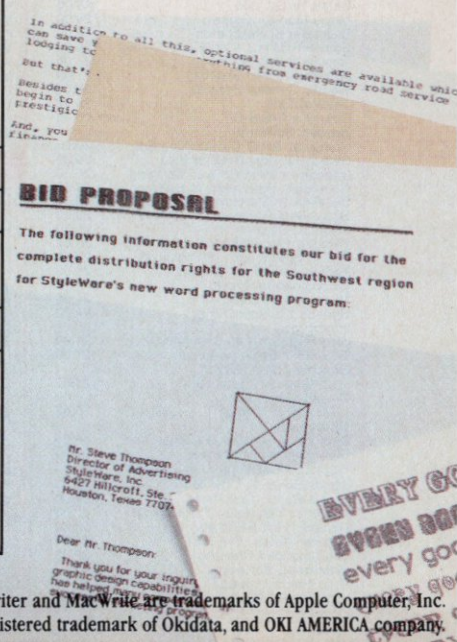

MultiScribe is a trademark of StyleWare, Inc. Apple is a registered trademark of Apple Computer, Inc. Apple IIe, Apple IIc, Imagewriter and MacWrite are trademarks of Apple Computer, Inc. Macintosh is a trademark licensed to Apple Computer, Inc. Epson is a registered trademark of Epson America, Inc. Okidata is a registered trademark of Okidata, and OKI AMERICA company.

Computers

Apple Computer	
Apple // e Color & Mono Systems	Call
Apple // c Color & Mono Systems	Call
Macintosh 512K Computers	Call
Macintosh Plus Computers	Call
Central Point Software	
Laser 128K Computer	349.00
The Laser 128 includes an Expansion Slot, RGB Video Output, Parallel Printer Port, and a 10 Key Numeric Keypad! Most Apple Compatible Computer Available at Any Price!	

BackUp Utilities/Boards

Alpha Logic Locksmith 6.0	59.00
Applied Technology Laboratory	
Copy Master II 128K w/Gr. Dump	92.00
Central Point Software	
Copy II Plus Version 6	20.00
Wildcard II	70.00
Computer Applications	
Nibbles Away III/ADOL	59.00
Golden Delicious Software LTD	
CIA Files	46.00
Utilico Software - E.D.D. IV	42.00
E.D.D. IV Plus (II, II+, //e w/Disk II)	109.00
E.D.D. IV Plus	119.00
(//e w/DuoDisk or UniDisk)	

Entertainment

Access Software	
Beach-Head or Beach-Head II	21.00
Accolade Dam Busters or Fight Night	20.00
Hard Ball of Laws or the West	20.00
Psi 5 Trading Co. or Sundog V2.0	20.00
Activision	
Alcizar or Master of the Lamps	24.00
Borrowed Time	24.00
Countdown to Shutdown	24.00
Ghost Busters or Pitfall II	24.00
Great American Road Race	24.00
Hacker or Space Shuttle	24.00
Little Computer People Discovery Kit	24.00
Mindshadow or Tracer Sanction	24.00
Star League Baseball	19.00
Alter Ego (Male or Female)	29.00
Avant Hill Under Fire!	34.00
Avant-Garde	
Dave Winfield's Batter Up	22.00
Bantam Publishing	
Cave of Time or Escape	22.00
Fourth Protocol	24.00
IDamiano the Wizard of Parastrada	24.00
Sherlock Holmes: "Another Bow"	24.00
Blue Chip Software	
Millionaire, Tycoon, Barron or Squire	24.00
Broderbund Ancient Art of War	24.00
Captain Goodnight & the Islands of Fear	21.00
Championship Lode Runner or Karateka	21.00
Mask in the Sun or Serpent's Star	24.00
Where in the World is Carmen, San Diego?	24.00
Data East Karate Champ	25.00
DataSoft Alternate Reality	27.00
Bruce Lee, Conan, or Mr. Do	22.00
The Goonies or Zorro	22.00
221B Baker Street	24.00
The Never Ending Story	24.00
Mind Pursuit	24.00
Electronic Arts	
Adventure Construction Set or Ogre	32.00
Archon II or One-On-One	25.00
Age Of Adventure	22.00
Wizard	28.00
Carriers At War or Wilderness	32.00
ChessMaster 2000	25.00
Europe Ablaze	32.00
Murder on the Zinderneuf	14.00
Music Construction Set	25.00
Pinball Construction Set	22.00
Reach for the Stars or Bard's Tale	28.00
Super Boulder Dash	22.00
7 Cities of Gold or Skyfox	25.00
Golden Oldies or Lords of Conquest	22.00
EPYX	
Koronis Rift or Eidolon	24.00
Barbie or G.I. Joe	19.00
Movie Monster Game	24.00
BullBlazer or Rescue on Fractulus	24.00
Summer Games II or Winter Games	24.00
Temple of Apsah Trilogy	24.00
World's Greatest Baseball	21.00
World's Greatest Football	24.00
Firebird Elite	26.00
Colossus Chess IV	00.00
Hayden Software	
Computer Novel Construction Set	30.00
Sargon III, Holy Grail, or Inca	30.00
Infocom A Mind Forever Voyaging	26.50
Cuthroats, Seastalker, or Ballyhoo	23.50
Deadline or Starcross or SpellBreaker	28.50
Hitchhiker's Guide to the Galaxy	23.50
Infidel or Sorcerer	26.50
Witness, Planetfall, or Enchanter	23.50
Zork I, Wishbringer, or Fobbitzky	23.50
Zork II, Zork III, or Suspect	26.50
Micro League Sports	
Micro League Baseball	24.00
General Manager/Owner	24.00
Microprose	
Solo Flight or Nato Commander	21.00
F-15 Strike Eagle or Acrojet	21.00
Gunship, Silent Service, or Kennedy Approach	21.00
Crusade in Europe or Conflict in Vietnam	25.00
Mindscape	
Deja Vu: "A Nightmare Comes True"	34.00
Dick Francis High Stakes	29.00
Forbidden Castle or Voodoo Island	24.00
James Bond: "A View To Kill"	24.00
James Bond: "Goldfinger"	24.00
Racter or The Halley Project	27.00
Rambo: "First Blood Part II"	24.00
Stephen King's "The Mist"	24.00
The American Challenge	29.00
Omnitrend Software	
Omnitrend's Universe I	62.00
Omnitrend's Universe II	39.00

One Step Software	
Golf Best Pinehurst	30.00
Origin Systems Moebius	37.00
AutoDuel	38.00
Ultima III: Exodus or Ultima IV	36.00
Sierra-On-Line	
The Quest, Ring Quest, or OO-Topos	20.75
Coveted Mirror or Xyphus	20.75
Sword of Kadsath or The Crimson Crown	20.75
Random House Alpine Encounter	24.00
Championship Boxing	21.00
Kings Quest or King's Quest II	30.00
The Black Cauldron	24.00
Simon & Schuster	
Super Zaxxon or Frogger 3 Deep	21.00
Spy Hunter, Tapper or Star Trek	27.00
Sir-Tech Wizardry	29.00
Knight of Diamonds	21.00
Legacy of Lylgarnyn	24.00
Rescue Raiders	21.00
Wisiprint	15.00
Spectrum HoloByte Gato	21.00
Synapse Software	
Brinone, Mindwheel, or Essex	27.00
Strategic Simulations	
Rings of Ziffin, or Colonial Conquest	28.00
Phantasia II, or Panzer Grenadier	28.00
Baltic 85 or Gemstone Warrior	20.50
Battalion Commander	24.00
Battle For Normandy	24.00
50 Mission Crush or Broadside	23.50
Geopolitique 1990 or Rails West	23.50
Germany 1985 or Carrier Force	35.50
Imperium Galactum	23.50
Kampgruppe or Reforger 88	35.50
North Atlantic '86	35.50
Operation Market Garden	30.00
War in Russia	47.50
U.S.A.F.	32.00
Battle of Antientum or Field of Fire	28.00
Battle Group	24.00
Sublogic Flight Simulator II	31.00
Tellurium Amazon or Dragon World	24.00
Fahrenheit 451 or Shadow Keep	24.00
Nine Princes in Amber	24.00
Perry Mason: Mandarin Murders	24.00
Rendezvous with Rama	24.00
Windham Classics	
Below the Root or	
Swiss Family Robinson	19.00
Treasure Island or Wizard Of Oz	19.00

Utility/Language Software

Apple Computer	
Apple II Instant Pascal	105.00
Apple Pascal V1.3	179.00
Champion Software Facelit 2	36.00
Corland Turbo Pascal 3.0	39.00
Turbo Database Tool Box	31.00
Turbo Tutor	21.00
Beagle Brothers	
MacroWorks or Beagle Basic	18.00
Beagle G.P.L.E.	27.00
Big U, Double Take, or Pro-Byter	18.00
Code or Extra K	21.00
Disk Quick of I.O. Silver	16.00
Dos Bos or Silicon Salad	13.00
Fat Cat	18.00
Tip Disk #1	11.00
Pronto Dos or Utility City	15.00
Triple Dump	21.00
Funk Software	
Sideways Prodos & Dos 3.3	32.00
Laserware Lisa V2.6	53.00
Meacom	
UniDos (Dos 3.3 for the UniDrive)	26.00
Microsoft Applesoft Compiler	102.00
Basic Compiler	239.00
Nikrom	
Master Diagnostics // e or II+	39.00
Pecan Software	
UCDOS Pascal	69.00
Quality Software	
Bag of Tricks II	30.00
Roger Wagner Merlin Pro	57.00
Merlin Assembler	39.00
Merlin Combo Pack	64.00
Software Masters	
Visible Computer: 6502	29.00
The Byte Works	
OPCAM Macro Assembler ProDos	59.00
Videx AppleWorks Modify Plus 64K	37.00
AppleWorks Modify Plus 128K	47.00
Vilberg Brothers	
DMP Utilities (ImageWriter or Epson)	39.00
Woodchuck Industries	
P-Trial: Basic to Pascal Translation	119.00
Zedcor ZBASIC	65.00

Graphics Packages

Activision Game Maker	30.00
Baudville	
Actors & Actions or Heros & Villains	18.00
Blazing Paddles	27.00
Prince (C. Itoh or Epson)	42.00
Pix-It	29.00
Shape Library 1, 2, or 3	12.95
Take I	34.00
Beagle Brothers Alpha Plot	21.00
Beagle Graphics	31.00
Flex Text or Frame Up	15.00
Font Mechanic or Minipix Disk #1	15.00
Shape Mechanic	21.00
Broderbund Dazzle Draw	36.00
Print Shop or Fantasion	29.00
Print Shop Companion	24.00
Print Shop Graphics Library	
I, II, or III	14.95
Print Shop Paper Refill	12.95
Data Transforms Fontrix 1.5	52.00
Font Paks 1-13 ea.	11.95
Electronic Arts Movie Maker	26.00
Penguin Software	
New Complete Graphics System	27.00
The Graphics Magician	35.00
Sensible Software	
The Graphics Department	65.00
Simon & Schuster	
Great Intl Paper Airplane	24.00
Const. Kit	24.00

Springboard Newsroom	32.00
DB Master Business Team	185.00
DB Master Business Writer	85.00
DB Master Version Four Plus	165.00
TimeWorks	
Silvia Porter's Financial Planner	59.00
Swiftcat with Sideways	105.00

Communications

Apple Computer	
Access // (//e //c only)	59.00
Compuserve	
Compuserve Starter Kit	20.00
Hayes Smartcom I	69.00
Terminal Program (Smartmodem)	59.00
Microsoft Crosstalk	99.00
Quark Termin // e	69.00
Softronics Softerm II	124.00
Source Telecomputing	
The Source On-Line Information Network	30.00
United Software Industries	
ASCII: Express Pro: Prodos or Dos 3.3	69.00

Business Software

Advanced Logic Systems	
SpellWorks	29.00
The Handlers (II+ //e //c)	97.00
Apple Apple Works (//e //c)	179.00
Apple Writer I / 2.0 ProDos (//e //c)	115.00
Quickfile (//e only)	75.00
Applied Software Technology	
Versaform //e //c	48.00
Arrays/Continental Software	
Home Accountant //e or //c	39.00
Tax Advantage 1985	37.00
Blythe Software Omnix 3	225.00
BPI Systems	
BPI General Accounting Dos 3.3	194.00
BPI ARI/APR or Inv. Dos 3.3 (ea.)	194.00
BPI General Accounting ProDos	209.00
BPI ARI/APR or Inv. ProDos (ea.)	209.00
Broderbund	
Bank Street Writer or Speller	41.00
Bank Street Filer or Mailer	41.00
CBS Software Stockpak II	89.00
Dow Jones Software	
Dow Jones Membership Kit	19.00
Electronic Arts Cut and Paste	22.00
Financial Cookbook	32.00
First Star The Works	30.00
Hayden Software	
The Writer	27.00
Human Edge Software	
Communications or Management Edge	27.00
Mind Prober	27.00
Mind Over Minors	27.00
Sales or Negotiation Edge	27.00
Howardsoft	
Real Estate Analyzer III w/Tax Preparer	189.00
International Solutions	
MouseBudget	39.00
MouseCalc	85.00
MouseDesk	24.00
MouseWord	69.00
Intuit Quicken	49.00
Kensington Microware	
Format II Enhanced	88.00
Living Videotext	
Think Tank II+ or //e	79.00
Manzanita	
BusinessWorks	
System Manager (Required)	65.00
GLARI/AP or Inventory Control	255.00
Payroll Module	290.00
The Business Accountant	
System Manager (Required)	69.00
GLARI/AP or Inventory Control	229.00
Payroll Module	229.00
The Advanced Business Accountant	
System Manager (Required)	69.00
GLARI/AP or Inventory Control	259.00
Payroll Module	295.00
MECA Managing Your Money	105.00
Megahaus MegaWorks	69.00
ReportWorks	69.00
ThinkWorks	Call
Monogram	
Dollars and Sense (//+, //e or //c)	68.00
Forecast (64K or 128K)	36.00
Nolo Press Will Writer	29.00
Paladin Flashcalc	59.00
PBI Software Graphworks 1.2C	59.00
Jeeves	38.00
Peachtree	
Back To Basics: GLARI/AP	98.00
Pinpoint Publishing Pinpoint	35.00
PinPoint Pop-up Spelling Checker	35.00
PinPoint Toolkit	26.00
PM Software ProFILER 2.1	69.00
Practicore Practical II	26.00
Precision Software SuperBase	54.00
Quark Catalyst //e V3.0	59.00
Word Juggler & Lexicheck //e	72.00
Roger Wagner Publishing	
Mouse Write	59.00
The Write Choice	27.00
Satellite Software Wordperfect	79.00
Sensible Software	
Bookends - ProDos	65.00
Sensible Grammar	55.00
Sensible Speller - Dos or ProDos	69.00
Sierra On-Line	
Homeward Plus (128K) or Homeward Filer	42.00
Homeward Speller	30.00
Screenwriter Professional	77.00
Simon & Schuster	
JK Lasser's Money Manager	47.00
JK Lasser's Income Tax	47.00
Software Publishing	
All Programs For //e with 128K or //c	
File (FileReport/Plan/Write)	139.00
PFS: File, Graph, Report	69.00
PFS: Write or Plan (//e //c)	69.00
Sorcim/IUS SuperCalc 3a	99.00
State of the Art	
Electric Checkbook	59.00
GLARI/AP/Inventory/Payroll	285.00

Stoneware	
DB Master Business Team	185.00
DB Master Business Writer	85.00
DB Master Version Four Plus	165.00
TimeWorks	
Silvia Porter's Financial Planner	59.00
Swiftcat with Sideways	105.00

Educational Software

Addison Wesley Smart Eyes	36.00
Apple	
Apple Logo I / 128K (//e //c only)	79.00
Bantam Books	
Fantastic Animals or Road Rally USA	24.00
The Complete Scarsdale Medical Diet	24.00
Barron's	
Computer SAT Revised Version	36.00
Brainpower Chipwits or Think Fast	24.00
Broderbund	
Science Tool Kit Master Module	36.00
CBS Software Adventure Master	26.00
America Coast to Coast	24.00
Body in Focus or Dinosaur Dig	24.00
Forecast or TRex	24.00

APPLE III ALTER EGO

Titan Technologies' III Plus IIe lets your Apple III emulate a IIe.

There was a time when thousands of Apple II owners longed for a device that would allow their machine to emulate the Apple III. As irony would have it, they might now need to convert in the opposite direction, and Titan Technologies (formerly Saturn) has just the set of plug-in boards with which to do it.

At first, this product appears to be a downgrade—something akin to the Plug and Play kit that made my Okidata 92 printer act like an IBM Graphics (i.e., modified Epson MX-80) machine and, in the process, removed some of its best features—but that is not the case here. In fact, Titan's III Plus IIe not only opens the Apple III's drives to virtually the entire Apple II and IIe software libraries, but it also enhances the III's natural functions.

Who would have believed it could come to this? I vividly recall the excitement surrounding the introduction of the Apple III a little over five years ago and the subsequent disappointment many of us shared when the first machine we laid eyes on—at a New York computer show—spewed garbage onto the screen, beeped pitifully, and died. As it turned out, this failed demonstration was not an isolated case of computer crib death, for Apple IIIs were popping their chips all over the country. I must admit that those of us who had invested one or two thousand dollars in an Apple II (and could ill afford to write that off and buy a III) breathed a

sigh of relief when the first release turned out to be less than wonderful, but Apple quickly diagnosed and cured the malady, thus generating renewed interest—not to mention a certain amount of jealousy.

Apple II owners had mixed feelings about the III. On the one hand, we marveled at its 128K RAM, up-and-down-arrows, numeric keypad,

*For the estimated
80,000-100,000
Apple IIIs still in
use, the Titan cards
represent a new
lease on life.*

built-in 80-column uppercase and lowercase display, 16 colors, enhanced graphics, and "typeahead" buffer; on the other hand, many people worried that the Apple II was being superseded, and nobody wants to be stuck with an obsolete computer. Of course, the Apple II did not die, it simply spawned the IIe and IIc models, new generations that today happily coexist with it.

For a variety of reasons, the Apple III did not fare as well. Some say it never quite recovered from its ill-fat-

ed start; others blame competition from Big Blue, which entered the microcomputer field with a solidly established image in the business community and placed its PCs on the very desks Apple had intended for its new machine. The final death knell—so the story goes—was sounded by Steve Jobs, who is said to have seen the III as a nuisance in the Macintosh's path. Notice that no one has blamed the machine itself; it remains an excellent computer that never got a chance to really prove its worth.

A New Lease on Life

Today, little or no new software is being written for the Apple III, but an estimated 80,000-100,000 units are still in use by a fiercely loyal group of owners, who will see the Titan cards as a new lease on their machine's life.

From the beginning, emulation of the Apple II and II Plus was a highly touted feature of the Apple III; its designers set out to create a business machine that serious Apple II owners could graduate to without rendering obsolete their accumulated software library. But the emulation went only so far: It enabled the Apple III to display the II's high-resolution graphics and 40-column text screens and to run virtually all programs that had been written for an unenhanced Apple II. The number of unenhanced IIIs was rapidly diminishing at that time, however; many 80-column cards were on the market, and more and more applications programs were



written to take advantage of them.

Thus, Apple II emulation meant little to Apple III owners whose needs went beyond running games or the earliest application software packages. As it turned out, even game players fell victim to incompatibility, for neither of the III's two game ports worked in the Apple II mode—the term *joysticks* became a misnomer. The Titan III Plus IIe solves the joystick problem (it has an on-board 16-pin game socket), but, since it emulates the IIe's 80-column card

rather than the old Videx or Double-Vision types, early 80-column Apple II programs remain incompatible. A PR#3 command invokes the 80-column feature, and some preboot programs might work, but Titan makes no guarantees in that direction. Since most of these game programs are now outdated, that handicap should be of little concern.

Installing the Titan

The III Plus IIe package comprises two Titan boards, one a modified version of a previously marketed Titan

Apple II emulation card, the other a new IIe card. Owners of unmodified Titan Apple II emulation cards can send them to Titan for an upgrade that costs \$175. Installing the two boards is a relatively easy task when you follow the furnished step-by-step instructions. Briefly, you first locate the video ROM on the motherboard and replace it with Titan's ribbon cable. A 24-pin connector on the other end of the cable goes into one of the Titan boards, which you press into slot 2 of the Apple III. You then link the two cards by way of another ribbon cable and place the second one in slot 3. Assuming that you have a parallel card in slot 1, you'll have only



Frustrated With Your IIe/c Word Processor/Speller? Let the Bard's 'Pro-Am' Writing System Calm You Down!

With the Bard you get 3 Word Processing levels, a built-in 50,000-word Spell Checker and an Animated Graphic Tutorial. All for the tranquilizing price of **\$69⁹⁵**

(Add \$3.50 for postage and handling)

Read what the reviewers and our customers say about the Bard's "Pro-Am."

"... THIS VALUE-PACKED word processor offers a level for every age and ability..."

HIGHEST RATING—FOUR STARS

Overall performance ★ ★ ★ ★
Documentation ★ ★ ★ ★
Ease of Use EASY!
Value for the Money ★ ★ ★ ★

(*Family Computing*, June issue, 1986)

"I HAVE NEVER THANKED a company for making a product before this time... Thank you for giving me an easy-to-use Apple Writing System for my whole family. The BARD is a winner! I have never been able to get my wife to touch a word processor. Before the BARD, she found the world of word processing beyond her. Now she uses it (the Starter's level) several times a week (to write letters). Our daughter (the youngest) has gone through the tutorials and is our Experienced (level) user... in less than half an hour she was rolling.

"Our sons have now switched (from AppleWorks to the BARD). The Spell Checker was instrumental in this decision. I am an article writer for magazines... and write every day. The BARD (Professional level) has made my work easier and fun again! One simply sits down and uses the BARD. A few checks here and there the program rolls. I learned it in about a half hour and have been using it ever since. The speed of the editing and formatting keeps me moving... the "Quick" function macros let me keep a barrel of usable goodies a keystroke away. The simple use of different printer fonts unleashes the printer (this is the first program which included my Gemini 10x as a regular part of the program).

"Thank you for living up to your advertising and the support you offer. Please consider me an automatic new customer for any of your new products. Just send them along."

(*The Rev. Philip G. Houghton, Waynesburg, PA.*)

Bard features include: Preview full pages before printing • 30 Popular Printers Set-Up Automatically • 50,000 Word Spell Checker Built in 40/80 Column Versions • Macros • Cut & Paste • Find & Replace • Destructive Overwrite • Illustrated Manual & Much More.

Writing Software International

90 Day Warranty. When ordering, specify ProDOS (requires 128 K, one drive) or 3.3 (requires 2 drives for Professional versions). For Demo Disk, refundable with purchase, send \$5 plus 75 cents postage and handling.

To order direct send \$69.95 + \$3.50 postage and handling
110 E. Broadway, Suite 600
Missoula, MT 59802
(406) 543-3141



The Apple III was created to be a business machine that II owners could graduate to without rendering obsolete their software library.

one vacancy left, which you can use for, say, a CP/M card.

Booting the Titan startup disk produces a menu (see figure 1) with three options: 1) START APPLE III OPERATION, 2) CHANGE IIe EMULATION, and 3) START APPLE IIe EMULATION. Option 2 yields a second menu, leading to options for

SLOT 1 PRINTER SETTINGS

- 1) Baud rate is 9600
- 2) NO Parity
- 3) Data Format is 8 Bits
- 4) 1 Stop Bit
- 5) Line Length is OFF
- 6) Page Length is OFF
- 7) Line Feeds are ADDED
- 8) HI-BIT is DISABLED

ENTER CHOICE BY NUMBER

(RETURN) FOR PREVIOUS MENU

Figure 1: Titan configuration menu for serial printers connected to the Apple III's RS-232C port

changing the serial-printer and communications settings (see figures 1 and 2). Changing a jumper on the board in slot 2 allows the computer to access a serial printer connected to the Apple III's built-in RS-232C port.

If you want to communicate with the outside world from the IIe mode,

SLOT 2 COMMUNICATIONS SETTINGS

- 1) Baud rate is 1200
- 2) NO Parity
- 3) Data Format is 8 Bits
- 4) 1 Stop Bit

ENTER CHOICE BY NUMBER

(RETURN) FOR PREVIOUS MENU

Figure 2: Titan configuration menu for communications device connected to the Apple III's RS-232C port

connect a modem to the serial port, and set the software accordingly. The Titan III Plus IIe software duplicates many of the Super Serial Card's functions, but not all, so you may run into trouble. I did not encounter any problems with the Hayes 300- and 1200-bps modems. If you are using the serial port for a printer, you probably don't have a parallel card in slot 1, and thus the solution to an eventual communications problem is to install the Super Serial Card, which the Titan cards can address if it has the

DISPLAY SLOT ASSIGNMENTS

STARTUP DISK: /USERS.DISK/

YOUR Apple //e HAS:

128K OF RANDOM ACCESS MEMORY

APPLESOFT IN ROM

SLOT 1: PARALLEL CARD

SLOT 2: I/O CARD

SLOT 3: 80-COLUMN CARD

SLOT 4: EMPTY

SLOT 5: PROFILE

SLOT 6: DISK DRIVE

SLOT 7: USED

PRESS RETURN TO DISPLAY MAIN MENU

Figure 3: With a parallel card in slot 1 and nothing in slot 4, the screen display shows how Titan's boards are emulating the IIe. Slot 5 is labeled PROFILE because it looks like a ProFile drive to the emulation, but it is actually the Titan's ProDOS RAMdisk.

proper jumper setting.

Because it carries its own complement of 128K RAM, the Titan card set can take advantage of the IIe's double high-resolution graphics display, which has a resolution of 560 x 192 dots per inch. Not all graphics programs work with this enhanced mode, so option 3 on the second menu lets you toggle this feature on or off, and you can change all these settings in midstream by pressing the open-apple/Reset combination, which brings back the main menu.

You can also move back and forth between the II and III modes without turning off the power.

Once you've configured the system, normal operation is a snap: Boot the startup disk, replace it with one containing the ProDOS or SOS system, and press the corresponding option number. If you want to see what kind of Apple IIe the Titan cards have turned your III into, run the ProDOS User's Disk and press S (for *Slot Assignments*). Figure 3 shows the screen that appeared on my machine.

FIRST TOTALLY PORTABLE APPLE //c

Take it with you
everywhere!



Apple //c
is a registered
trademark of Apple
Computer Inc.

System Features:

- 24 Line by 80 Character LCD Display
- 8 Hour rechargeable power supply
- 21 lb. total system weight including //c
- Durable Cordura carrying case with handle and shoulder strap

Lowest Prices Yet!

- | | |
|---------------------------------------|-----------------|
| • C-VUE Flat Panel Display | REDUCED! 399.00 |
| • PRAIRIE POWER Battery Pack and Case | REDUCED! 150.00 |
| • Checkmate Technology Specials: | |
| 512K Multiram™ CX Board | REDUCED! 225.00 |
| 768K Multiram™ RGB Board | NEW! 269.00 |
| 768K Multiram™ //e Board | NEW! 219.00 |
| • Apple //c Computer* | 750.00 |

NEW! No Portable System Is Complete Without These:

- | | |
|---------------------------------------|-------|
| • Apple //c Cigarette Lighter Adapter | 29.95 |
| • Apple //c Power Extension Cable | 19.95 |
| • Apple //c Power Y-Adapter | 22.95 |

FREE! Price Quotes on all Apple Products & Peripherals

Ordering Information:

1-800-GET-CVUE (outside California)
(619) 274-1253 (within California & outside U.S.)

MasterCard and VISA accepted.

Prices subject to change without notice

ROGER COATS P.O. BOX 171466 SAN DIEGO, CA 92117



14-day
money-back
guarantee

Checkmate Technology, Inc.
*not sold individually

CIRCLE 109 ON READER SERVICE CARD

**WITH THIS
ONE PROGRAM
YOU CAN EASILY
DESIGN,
ORGANIZE,
FILE,
SEARCH,
SORT,
CALCULATE,
MERGE,
AND PRINT
USING FLOPPY
OR HARD DISK.**



**ALL FOR
ONLY \$99.95.**

**ProFILER 2.1 - A SINGLE-DISK
DATA MANAGER/REPORT GENERATOR**

With ProFILER 2.1, you get power, flexibility, and ease of use—all on one floppy disk. And you can easily transfer all your data to hard disk without additional data entry. To get a whole lot more out of your Apple—for a whole lot less—order today.

- Up to 1500 records per floppy—65,000 on hard disk
- Multiple files per disk, multiple index files, full screen editor
- ProDOS generates reports 8 times faster than DOS 3.3
- AppleWorks compatible
- Optional data conversion program for PFS users

See your dealer or order today!

1-800-628-2828 Ext. 530

Plus \$3 shipping and 6% CA tax

Dealer Inquiries Invited



Software

17610 Beach Blvd. Suite 29
P.O. Box 1788
Huntington Beach, CA 92647
714-963-2221 • 714-841-7400

ProFILER 2.1 developed by Custom Computer Products. PFS is a registered trademark of Software Publishing Corp. Apple, ProDOS, and AppleWorks are registered trademarks of Apple Computer, Inc. Price shown reflects suggested retail.

It looks great, but does it really work? You bet. The first program I tried was Word Perfect, and all went well until I had to delete a character and searched the Apple III keyboard in vain for a Delete key. The Titan people have solved the problem simply by giving Control-Shift-Backslash the same effect. Next I ran AppleWorks, with equally smooth results. In fact, the III can outperform

*All in all, a
bona fide Apple IIe
can do little
that the \$399
Titan III Plus IIe
cards can't emulate.*

the IIe, because even its numeric keypad and two-speed keystroke-repeat feature function properly in the IIe emulation mode.

When I spent a whole evening running every conceivable type of Apple II program on the III, I soon realized that anything I could run on my Apple IIe also ran on the emulated IIe. In each case, I made vain attempts to crash the program or, at the very least, run into a snag, but the real IIe duplicated the frustrations as well as the joys. When I had a slight problem with the graphics on Newsroom, the solution was to turn off the double-hi-res mode. Since Word Juggler, for a long time my favorite word processor, was originally written for the Apple III, it made little sense to run the IIe version in the emulation mode, but I tried it anyway, and it also worked splendidly. The only Apple IIe program that refused to run was SuperCalc 3a, but it failed only because it requires a CMOS 6502 (65C02B) microprocessor. Not really a problem, because this chip, which you find in the Apple IIc and newer IIe computers, is easy to install in the Apple III, replacing the NMOS 6502B.

RAM Bonuses

The Titan startup disk contains two RAMdisk programs, one of which activates automatically. It checks to see how much memory your Apple III has in its main memory and then installs as much of that

as possible as a RAMdisk. In the case of a 256K Apple III, that means a 192K RAMdisk—enough to hold a good dictionary, for example. Although installation is automatic, you have to format the RAMdisk before you can use it.

I mentioned at the beginning of this review that the Titan cards enhance Apple III operation, and this improvement involves an SOS RAMdisk, which requires more setup work, but is well worth the trouble. The Titan startup disk contains an SOS RAM driver that you must first transfer to your application disk by way of the Systems Configuration Program (SCP). If the disk has insufficient space, you can set up a two-stage loading procedure. For you experienced SOS users, the configuration should be a breeze; others may find it slightly complicated, but the Titan manual contains clear, step-by-step instructions.

I was sorry to discover that the Titan cards couldn't address my high-capacity Micro Sci A143 floppy drive in IIe emulation, but I'm not so sure that I can't do something to rectify that. On the other hand, they do work with a ProFile hard disk and (under ProDOS) the Apple III's clock/calendar chip. The Titan emulator doesn't provide flashing characters and MouseText (icons) either, but wouldn't you really rather have the other extras?

All in all, a bona fide Apple IIe can do little that the \$399 Titan III Plus IIe cards can't emulate. That versatility and the aforementioned RAMdisk features make this a highly recommended addition to any Apple III. It might even serve as an inducement to purchasing a III, which (I am told) has dropped to about \$400 on the used market. +

Chris Albertson is a New York music critic who has been using Apple computers since 1979.

PRODUCT INFORMATION

Titan Technologies, Inc.

Distributor:
Sun Data
851 North Main
Logan, UT 84321
(800) 821-3221

List Price: \$399 (upgrade of Titan II card, \$175)

Requires: Apple III, ProDOS

CIRCLE 368 ON READER SERVICE CARD

To boldly go at speeds no Apple has gone before.

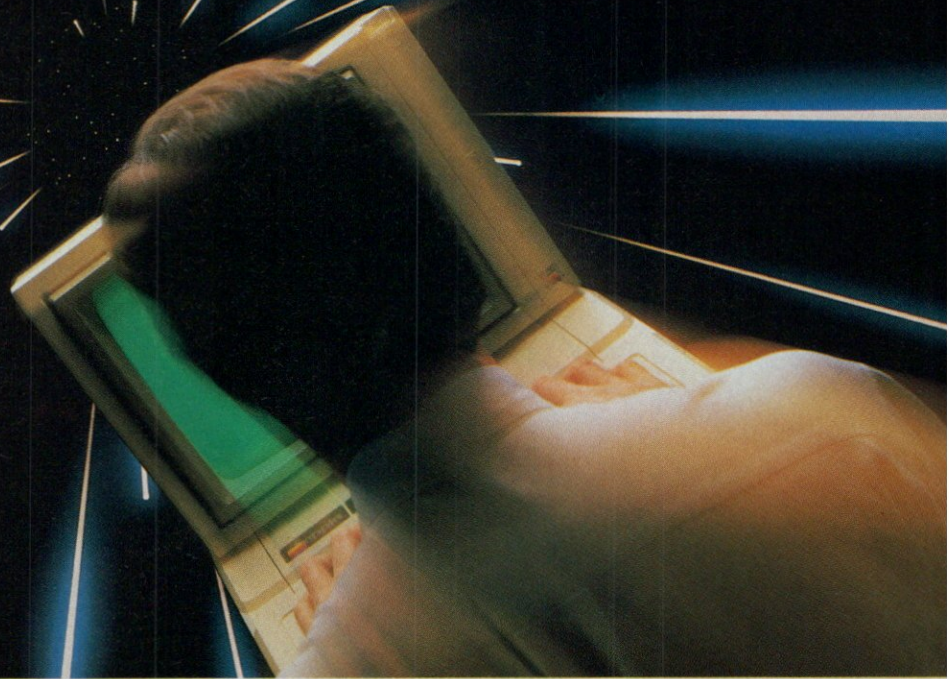

Get TransWarp™. The fastest accelerator you can buy for your Apple™ IIe, II, or II+.

Computing at warp speed!

It's an experience you shouldn't miss. And with TransWarp, you won't have to. Because TransWarp will run your software up to 3.6 times faster — leaving other accelerators in the stardust!

No more yawning while your Apple™ slowly rearranges text or calculates spreadsheets. With 256K of ultra-fast RAM, TransWarp speeds up *all* Apple software — including AppleWorks, SuperCalc 3a, Visicalc, and all educational software, graphics and games. And it's compatible with all standard peripheral cards (such as RamWorks II and Apple memory cards), Profile and Sider hard disks, 3½" UniDisks, 80-column cards, modems, clock cards, mouses and more! You name it, TransWarp accelerates it. There's even a 16 bit upgrade chip available should 16 bit software become available for the Apple.



"I recommend Applied Engineering products wholeheartedly."

*Steve Wozniak, the creator
of Apple Computer*

An important difference.

TransWarp's not the only speedup card on the market. But it's the only one that accelerates your Apple's main memory, ROM and auxiliary memory. And with more and more programs residing in auxiliary memory, buying anyone else's accelerator makes less and less sense. TransWarp even works with most D.M.A. devices including the Swyft™ card.

There's one more difference. Since TransWarp doesn't use memory caching, it accelerates *all* software — and not just most of it.

A cinch to use.

Simply plug TransWarp into any slot in your Apple II, II+ or IIe — including slot 3 in the IIe. Instantly you'll be computing at speeds you only dreamed about before. And should you ever wish

to run at normal speed, simply press the ESC key while turning your Apple on.

Since TransWarp is completely transparent, you won't need pre-boot disks or special software. It's ready to go right out of the package!

Speed = Productivity

Imagine the productivity gains you'll achieve when your programs are running over three times faster. TransWarp is so powerful, your Apple will make IBM PCs™ and even ATs™ look like slowpokes — whether you're planning taxes, plotting charts or playing games! Take a look at a few of the features that set TransWarp apart:

- 3.6 MHZ 65C02
- 256K of ultra-fast on-board RAM
- Accelerates main *and* auxiliary memory
- Low power consumption for cool operation
- Totally transparent operation with all software
- Plugs into any slot, including slot 3 on the Apple IIe
- Accelerated 16 bit option available

Satisfaction guaranteed!

Give *your* Apple the TransWarp advantage. With our risk-free 15-day money back guarantee, you have nothing to lose but wasted time. Call today!

TransWarp Accelerator \$279
16 bit upgrade (may add later) \$89

For fast response:

Call Applied Engineering, 9 a.m. to 11 p.m., 7 days at (214) 241-6060. MasterCard, VISA and C.O.D. welcome. Texas residents add 5% sales tax. Add \$10.00 if outside U.S.A.

Or mail check or money order to Applied Engineering, P. O. Box 798, Carrollton, TX 75006.

AE Applied Engineering
The Apple enhancement experts.

P. O. Box 798, Carrollton, TX 75006 (214) 241-6060



THE DAILY SUN

^lThis story is the hottest news this paper has ^tseen since the mayor took a sledgehammer to his own garbage can eight months ago to protest the trash collectors' strike.

As a cub reporter with less than two years on the staff of the Daily Sun, I knew this scoop was my guaranteed ticket to a whopping big promotion.

For the last seven months, I had doggedly stalked the facts, following the thread of corruption through office after office at City Hall.

Kickbacks ^{were} the name of the game, and the top players ranked from the mayor's right-hand aids to the supervisor of the city's largest project. Some very big heads were going

Until today, I hadn't told a ^{soul} not even

W strike... less than... Daily Sun I knew this... to a who... the ad ne... office... office of... the name of the game... the ma... ity... players...

THE DAILY SUN
This story is the hottest news this paper has seen since the mayor took a sledgehammer to his own garbage can eight months ago to protest the trash collectors' strike.

an ex... CRA' take... re...

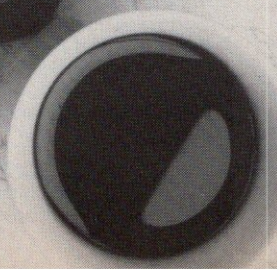

Spell It ~~Write~~ ^{Right}

The latest in orthographic aids for Apple II word processing

This story is the hottest news this paper has scene since the mayor took a sledge-hammer to his own garbage can eight months ago to protest the trash collectors' strike.

As a cub reporter with less than two years on the staff of the *Daily Sun*, I knew this scoop was my guaranteed ticket to a whopping big promotion.

For the last seven months, I had doggedly stawked the facts, following the thread of corruption through office after office at City Hall.

Kickbacks was the name of the game, and the top players ranked from the mayor's right hand aids to the supervisor of the city's largest presinct. Some very big heads were going to roll, and I was going for a run of tenpin strikes!

Until today, I hadn't told a sole, not even Mother. It wasn't easy making up excuses for the hours I spent night after night tailing suspects. Mother said I was neglecting her, but I knew she suspected another woman. After all, I'm all she's got since Dad dies, she reminds me every morning as she serves me my sof boiled egg on toast.

Anyway, all will be forgiven when I tell her the turth tonight and announce my pramotion.

Here comes the editor-in-shief now with my story in hand! A quick ajustment of my glasses—they've got heavy black frames and a bad habit of falling down my nose when I'm typing. It wouldn't do to face the turning point in my career with my glasses asque.

"Bailey?" he says in that gruff, tobaco-stained voice I love and fear so much.

"Yessir!" I say, pride already putting a sizable lump in my throat.

"Is there any hope of your ever lerning how to spell?"

As many of us know so well, no matter how hot the story or how important the information, spelling and typographical errors reflect poorly on a writer. In the case of business letters and press releases, the bad impression can go beyond the writer and reflect poorly on

the company he or she represents.

If the sad tale of the cub reporter strikes a chord in you, you'll be relieved to know that help is on the way. Software publishers have trained a valuable and powerful player to add to the word-processing team. Spelling checkers, either stand-alone or built

into word-processing programs, have reached a peak in terms of speed, ease of use, automatic correction capabilities, and even the incorporation of some artificial-intelligence techniques. Fulfilling a broad range of requirements, from those of young students writing term papers to those of professional journalists, spelling checkers are a must if you strive for perfection in your written communications (and who doesn't?).

Word-processing programs may include a built-in spelling checker, or the manufacturer may provide a spelling checker that works with the word-processing program. Spelling checkers fall into three main categories. Those that are included in, or can be installed into, a word-processing program are considered integrated, because you do not have to leave the word-processing program to check the spelling of your documents. The second group works with specific word-processing programs, and the third group works with any word-processing program that saves documents as ASCII text files. The spelling checkers in the latter two categories require you to leave the word-processing program and then start the spelling-checker application in order to check your documents.

If you already own a word-processing program, look for a spelling checker that works specifically with your program. If your word-processing program is not listed in the chart that accompanies this article but saves documents as ASCII text files, you are still in luck.

This review will cover the the best-known spelling checkers for the Apple II series and a few recent arrivals. The chart that follows presents the remaining programs and their basic features.

Although spelling checkers offer a variety of capabilities, the basic operating premise is the same for all of them. They all contain a dictionary database, but some programs have more words in the database than others do, and almost all allow you to add your own words. When you begin spell-checking, the program instructs you to load your document (unless the checker is integrated with your word-processing program, in which case you can spell-check without leaving the word-processing program) and compares the data, or words, in your document to the words in its dictionary database. If a word is not in the program's dictionary database, the spelling checker lets you know, in most cases, by highlighting the word in context.

Of course, the more words a spelling checker's dictionary has, the more effective and complete the correcting job will be. No spelling checker can take the place of a good human proofreader for complete accuracy, however. As we delve deeper into the correcting process, you'll see why.

The first thing you'll want to ascertain in choosing a spelling checker is which programs can work with your word-processing program. If you haven't yet purchased a word-processing program, you'll want to consider those with built-in spelling checkers. In general, you can save time by eliminating the need to switch disks if the spelling checker is integrated with a word-processing program.

Two valuable features to look for in a spelling checker are the ability to suggest alternative spellings and the provision for you to scroll through the program's electronic dictionary, thereby eliminating the need to leave your work to search through a printed dictionary if the program does not come up with the correct alternative spelling to a misspelled word. In general, you can choose one of the alternative words and prompt the program to replace the word automatically with your choice, or you can type a replacement directly into your document.

The suggested alternative spellings are usually based on words listed close to the misspelled word in the dictionary that use similar letters. They appear, with instructions and options, in a "proofing window" next to your document. Sometimes they're amazingly helpful, sometimes not. For instance, the incorrect word *presinct* in

Spelling Checkers

PRODUCT	COMPATIBLE WITH	TYPE	PRICE	# WORDS IN DICTIONARY
Bank Street Speller Bröderbund Software 17 Paul Drive San Rafael, CA 94903 (415) 479-1700	Bank Street Writer	Stand-Alone	\$69.95	30,000
Haba Spell It Haba Systems, Inc. 6711 Valjean Avenue Van Nuys, CA 91406 (818) 901-8828	AppleWorks word-processing program	Stand-Alone	\$49.95	33,000
Magic Words Artsci, Inc. 5547 Satsuma Avenue North Hollywood, CA 91601 (818) 985-5763	Magic Window (all versions), AceWriter, any ASCII file	Stand-Alone	\$69.95	14,000
MECC Speller (A134) MECC (Minnesota Educational Computing Corporation) 3490 Lexington Ave. North St. Paul, MN 55126-8097 (612) 481-3500	MECC Writer, Apple Writer II	Stand-Alone	\$39	10,000+
MegaWorks Megahaus Corporation 5703 Oberlin Drive San Diego, CA 92121 (619) 450-1230	AppleWorks word-processing program	Stand-Alone	\$125 (includes mail merge)	40,000
Pinpoint Spelling Checker Pinpoint Publishing Box 13323 Oakland, CA 94661 (415) 654-3050	AppleWorks word-processing, database, and spreadsheet programs	Integrated	\$69	61,000
PowerSpell Beaman Porter, Inc. 417 Halstead Avenue Harrison, NY 10528 (914) 835-3010 (914) 835-3156	PowerText	Stand-Alone	\$50	6000+
Random House Proofreader Digital Marketing 1136 Saranap, Ste. P Walnut Creek, CA 94595 (415) 947-1000	WordStar and approx. 200 other word-processing programs	Stand-Alone	\$50	32,000
Sensible Speller Sensible Speller IV Sensible Software, Inc. 210 S. Woodward, Ste. 229 Birmingham, MI 48011 (313) 258-5566	Most major word-processing programs, any ASCII text file	Stand-Alone	\$125	80,000+
Spellbound Quorum Internationale, Unlimited Box 2134APE Oakland, CA 94621 (415) 769-6080 (800) 222-2824 In CA (800) 222-2812	AppleWorks word-processing program	Integrated	\$49.95	1000

MAKES ADDITIONS TO MAIN DICTIONARY	CREATES PERSONAL DICTIONARY	DISPLAYS SUSPECT WORDS IN CONTEXT	SUGGESTS SPELLING	SCROLLS DICTIONARY	WILD-CARD CHARACTERS FOR SEARCHING DICTIONARY	REQUIRES	OPERATING SYSTEM	UNIDISK 3.5 ALSO
						Apple II Plus, IIe, or IIc; 2 disk drives	N/A	
	2 disk drives required							
						Apple IIe with Extended 80-Column Card, or IIc	ProDOS	
	2 disk drives recommended							
						Apple II, II Plus, IIe, or IIc	DOS 3.3	
						Apple IIe or IIc	DOS 3.3	
						Apple IIe with 128K RAM, or IIc	DOS 3.3	 read only
						Enhanced Apple IIe with Extended 80-Column Card, 2 disk drives, extra RAM, speed-up card, and UniDisk 3.5 recommended, or IIc	ProDOS	
	2 disk drives required							
						64K version: Apple II or II Plus, 64K RAM, 2 disk drives; 128K Version: Apple IIe, 128K RAM, or IIc; 2 disk drives	Pascal 1.2	
	2 disk drives required							
						CP/M card	CP/M	
						Apple II Plus with 64K RAM, IIe, or IIc	ProDOS (SS) DOS 3.3 (SSIV)	
	2 disk drives required							
						Apple IIe with Extended 80-Column Card and 128K RAM, or IIc	ProDOS	

HARDWARE

- CCS
 \$ 99. 7711 Or 7710-A Serial Card
CENTRAL POINT
 79. Wild Card II Copier
C H PRODUCTS (HAYES)
 29. Mach II Joystick (II+ Or IIe)
 37. Mach III Joystick (II+ Or IIe)
INTERFACE MODULES
 39. 64K & 80 Column Card (Ile)
 49. Floppy Drive Controller (II+, Ile)
 155. Full Ht 143K Floppy Drive (Ile)
 155. Half Ht 143K Floppy Drive (Ile)
 155. Half Ht 143K Floppy Drive (Ile)
KENSINGTON
 69. System Saver Fan
KOALA
 75. Touch Tablet
ORANGE MICRO
 49. Hot Link Serial To Parallel Cable (Ile)
 79. Grappler Plus or Grappler C
 135. Buffered Grappler Plus
QUARK
 995. 10 MB Hard Disk (Ile, Iic, Or Mac)
SMT
 39. Parallel Interface And Cable (II+, Ile)
TG PRODUCTS
 19. Joystick (Ile, Iic)
TITAN
 155. 128K RAM Card
 229. Accelerator Ile
TRACKHOUSE
 79. Numeric Keypad (Ile)
VIDEX
 179. Videoterm 80 Column Card
 189. Ultraterm 132 Column Card
 25. Soft Video Switch

DISKETTES

- CONROY-LAPOINTE**
 \$ 13. 10 ea. 5 1/4" SS/SD (Apple)
 99. 100 ea. 5 1/4" SS/DD (Apple)
 25. 10 ea. 3 1/2" SS/DD (Mac)
 115. 50 ea. 3 1/2" SS/DD (Mac)
 29. 10 ea. 3 1/2" DS/DD (Mac)
 115. 50 ea. 3 1/2" DS/DD (Mac)
 259. 100 ea. 3 1/2" DS/DD (Mac)
MAXELL
 13. 10 ea. 5 1/4" SS/DD (Apple)
 32. 10 ea. 3 1/2" DS/DD (Mac)

MONITORS

- AMDEK**
 \$119. 300G 12" Green Composite
 129. 300A 12" Amber Composite
ZENITH
 109. 1220 Amber Composite
 109. 1230 Green Composite

6. RCA Monitor Cable

PRINTERS

- EPSON**
 \$289. AP 80 75 cps, 15 NLQ
 389. FX 85 160 cps, 32 NLQ
STAR MICRO
 289. NX 10 120 cps, 25 NLQ
 379. SD 10 160 cps, 40 NLQ
PANASONIC
 269. P 1091 120 cps
SMT
 39. Parallel Card With Cable
CENTRAL POINT
 19. Laser 128 Parallel Printer Cable

MODEMS

- US ROBOTICS**
 \$299. 1200 External
 499. 2400 External

SURGE SUPPRESSORS

- CURTIS**
 \$ 29. Diamond 6 Outlets
 35. Emerald 6 Outlets, 6' Cord
 46. Sapphire 3 Outlets, RFI Filter
 55. Ruby 6 Outlets, RFI Filter, Cord

UTILITY SOFTWARE

- BORLAND**
 \$ 42. Turbo Pascal (Requires CP/M)
 36. Turbo Toolbox
CENTRAL POINT
 23. Copy II Plus
DATA TRANSFORMS
 63. Fontrix
FUNK
 37. Sideways (DOS 3.3 Or ProDOS)
MICROSTUF
 109. Crosstalk (Requires CP/M)
OMEGA
 75. Locksmith
TERRAPIN
 59. Logo
UNITED
 79. ASCII Express (DOS 3.3 Or ProDOS)
VIDEX
 35. Appletworks Modifier

Your full line, full service discount computer source.

BUSINESS SOFTWARE

- ASHTON-TATE**
 dBase II (Requires CP/M)
BPI
 219. Gen. Accounting, AR, AP, PR (Ile)
 235. Gen. Accounting, AR, AP, PR (ProDOS)
DOW JONES
 145. Market Manager Plus
 199. Market Analyzer
LIVING VIDEOTEXT
 89. Think Tank
MEGAHAUS
 75. Megaworks Or Reportworks
MICROPRO
 265. WordStar Professional
MICROSOFT
 62. Multiplan (DOS)
PINPOINT
 42. Pinpoint
QUARK
 79. Word Juggler & Lexichex
SSI (SATELLITE)
 99. WordPerfect
SOFTWARE PUBLISHING
 79. PFS: File, Write, Graph Or Report

GAMES

- ELECTRONIC ARTS**
 \$ 29. Sky Fox Or Dr. J & Larry Bird
 39. Ultima III Or IV
HAYDEN
 30. Sargon III
INFOCOM
 29. Hitchhiker's Guide Or Zork I, II Or III
MICROPROSE
 23. F-15 Strike Eagle
SPECTRUM HOLOBYTE
 25. GATO (Requires 128K)
 30. Orbiter Or Tellstar I (Ile, Iic)
 49. Tellstar II (Ile, Iic)
SUBLOGIC
 33. Flight Simulator II

HOME & EDUCATIONAL

- BRODERBUND**
 \$ 32. The Print Shop
 38. Print Shop With Refill
 45. Bank Street Mailer Or Filter
 85. Bank Street Combo
MONOGRAM
 79. Dollars & Sense (II+, Ile Or Iic)
SIMON & SCHUSTER
 33. Typing Tutor III Or Spell Check
SPRINGBOARD
 19. Clip Art Vol 1
 27. Clip Art Vol 2
 35. Newsroom

1•800•547•1289

Business Accounts: 1•800•4•CONROY

In Oregon: 1•800•451•5151

Hours: 6-6 Pacific Mon-Fri, 8-4 Sat • Local: (503) 620-9878

ORDERING INFORMATION

- Most orders shipped second day air.
- Heavy items may require additional shipping charges.
- Shipping Charges:
- US & Puerto Rico — 3% (\$6 minimum)
- Prices reflect a 3% discount for Conroy-LaPointe Credit Card or cash.
- APO, FPO — US rate PLUS \$5
- Add 3% for other credit card purchases.
- Canada — 12% (\$15 minimum)
- Foreign — 18% (\$25 minimum)
- Customer Service: (503) 620-9877



LASER 128: Better than Apple[®] at half the price.

- 128K RAM, 32K ROM
- External Drive Port
- 65C02 CPU
- Numeric Keypad
- 5 1/4" Floppy Drive, Internal
- 4 Cursor Keys
- 1 Expansion Slot, Ile
- 10 Function Keys
- 1 Parallel Port
- Supports Double Hi Res
- 2 Serial Ports
- Mouse/Joystick Port

\$499 With Monitor And Cable

\$949 Includes Monitor, 2nd Floppy Drive, Printer, Cables **A40**

Conroy•LaPointe Inc.

RamFactor™

All the Performance, Speed, and Software Compatibility of RamWorks™ in a Slot 1 through 7 Card.

That's right! Now Applied Engineering offers you a choice. While RamWorks is the dear winner for the auxiliary slot in a Ie, RamFactor is the standard for slots 1 through 7. Now anyone with an Apple II+, Franklin, or Apple Iie preferring to use slots 1 through 7 can now enjoy the speed and performance that until now was only available with RamWorks.

With RamFactor, you'll be able to instantly add another 256K, 512K, or a full 1 meg on the main board and up to 16 meg with additional piggyback card. And since virtually all software is automatically compatible with RamFactor, you'll immediately be able to load programs into RamFactor for instantaneous access to information. You'll also be able to store more data for larger word processing documents, bigger data bases, and expanded spreadsheets.

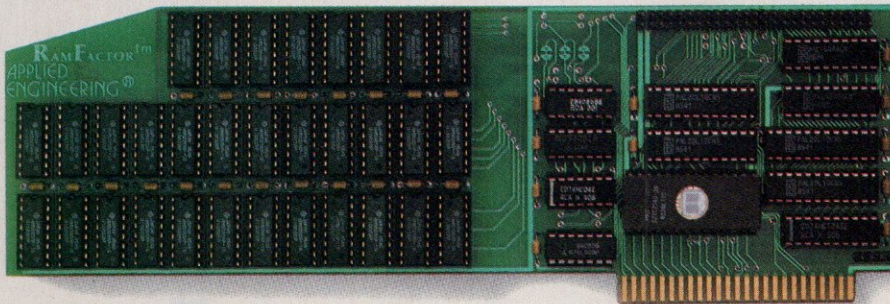

Very Compatible

All the leading software is already compatible with RamFactor. Programs like AppleWorks, Pinpoint, BPI, Managing Your Money, Dollars and Sense, SuperCalc 3A, PFS, MouseWrite, MouseDesk, MouseCalc, Sensible Speller, Applewriter Iie, Business Works, ReportWorks, Catalyst 3.0 and more. And RamFactor is fully ProDos, DOS 3.3, Pascal 1.3 and CP/M compatible. In fact, no other memory card (RamWorks excepted) is more compatible with commercial software.

AppleWorks Power

There are other slot 1-7 cards that give AppleWorks a larger desktop, but that's the end of their story. But RamFactor is the only slot 1-7 card that increases AppleWorks internal memory limits, increasing the maximum number of lines permitted in the word processor, and RamFactor is the only standard slot card that will automatically load AppleWorks into RAM dramatically increasing speed and eliminating the time required to access the program disk, it will even display the time and date on the AppleWorks screen with any ProDos clock. RamFactor will automatically segment large files so they can be saved on 5¼", 3½", and hard disks. All this performance is available to anyone with an Apple Iie or II+ with an 80 column card.

RamFactor, no other standard slot card comes close to enhancing AppleWorks so much.

True 65C816 16 Bit Power

RamFactor has a built-in 65C816 CPU port for direct connection to our Iie 65C816 card for linearly addressing up to 16 meg for the most powerful 16 bit applications. (II+ 65C816 card under development.)

Powerful Program Switcher

With RamFactor, you can organize memory into multiple work areas and switch between them. Each work area can contain different programs and even different operating systems. Now you can switch from one program to another or even switch from AppleWorks to DOS 3.3 to CP/M to Pascal to ProDos in under a second. And with our Battery back-up option, you can have permanent storage for up to 20 years.

Quality and Support of the Industry Leader

RamFactor is from Applied Engineering, the largest, most well supported manufacturer of Apple peripherals and the inventor of large RAM cards for the Apple. With our 5 year no hassle warranty and outstanding technical support, you're assured of the most trouble free product you can buy.

Features:

- Up to 16 meg total memory, 256K to 1 meg on main board. Up to 16 meg with additional memory on piggyback card.
- Fully Apple II Memory Expansion compatible
- Compatible with Apple Iie, II+ and Franklin
- Battery back-up option allows you to turn on your Apple and run your favorite programs in less than 1 second!
- Automatically recognized by ProDos, DOS 3.3, Pascal and CP/M
- Built-in RamDrive™ software (a true RAM disk not disk caching)
- Systems are directly bootable from RamFactor if desired
- Built-in linear addressing 16 bit co-processor port
- Built-in self diagnostic software
- Automatic expansion with AppleWorks 1.3 or later
- Allows Apple II+ and Iie to run your AppleWorks without buying additional software
- Accelerates AppleWorks
- Displays time and date on the AppleWorks screen with any ProDos clock
- Fits any I/O slot except slot 3
- Fully socketed and user upgradeable
- Much, much more

RamFactor with 256K	\$239
RamFactor with 512K	\$289
RamFactor with 1 MEG	\$389
RamFactor with 2-16 MEG	CALL
Battery Back-up Option	\$179
65C816 16 Bit Card	\$159

Order RamFactor today . . . with 15 day money back guarantee and our "no hassle" five year warranty. Call 9 a.m. to 11 p.m., 7 days, or send check or money order to Applied Engineering. MasterCard, Visa and C.O.D. welcome. Texas residents add 5½% sales tax. Add \$10.00 if outside U.S.A.

AE Applied Engineering
The Apple enhancement experts.

(214) 241-6060

P.O. Box 798, Carrollton, TX 75006

the sample document is somewhat removed from the correctly spelled *pre-cinct* in the dictionary, so suggested spellings would be something like *pre-scient* or *prescience*. If you don't have a clue how to spell the word, your alternatives are to scroll through the words beginning with *pre* in the program's dictionary or to ask the person in the next office.

No spelling checker can catch words spelled correctly but used incorrectly. For example, take the words *scene* and *sole* in the sample document. Since both words appear in most spelling-checker dictionaries, they pass as correct.

A nice feature common to all the programs in this review is that they let you customize their dictionaries to fit your personal writing needs, either by adding your own words to the spelling checker's database or by creating a dictionary from scratch on a separate disk. So if you work with a lot of terms that the spelling-checker dictionary lacks, you can add those words to your program's dictionary as you create documents. Many specialized dictionaries, already compiled and available on disk, cover legal, medical, and techni-

SPELLING CHECKERS, CONTINUED

PRODUCT	COMPATIBLE WITH	TYPE	PRICE	# WORDS IN DICTIONARY
Spell Perfect LJK, Inc. 7852 Big Bend Blvd. St. Louis, MO 63119 (314) 962-1855	Letter Perfect, Simply Perfect, any ASCII file	Stand-Alone	\$79.95	30,000
Spellworks Advanced Logic Systems 1195 East Arques Ave. Sunnyvale, CA 94086 (408) 730-0307	AppleWorks word-processing program	Stand-Alone	\$49.95	90,000
The Speller Palantir Software 12777 Jones Road, Suite 100 Houston, TX 77070 In TX (713) 955-8880 (800) 368-3797	The Word Processor, any ASCII text file	Stand-Alone and Integrated	\$145	60,000
Webster's New World Spelling Checker Simon & Schuster Gulf + Western Bldg. 1 Gulf + Western Plaza New York, NY 10023 (201) 592-2900	Apple Writer II, Bank St. Writer, PIE:Writer, Screen Writer II, Perfect Writer, Textra, Word Perfect, AppleWorks word-processing program, any ASCII file	Stand-Alone	\$59.95	114,000
WordPerfect V.1.0 WordPerfect Corp. 288 West Center Street Orem, UT 84057 (801) 227-4370	WordPerfect	Integrated	Upgrade \$30	50,000+

The best AppleWorks-Compatible spelling checker just got better! Introducing the improved... Sensible Speller™

The new ProDOS Sensible Speller supports the Apple II Memory Expansion Card and is now supplied on the UniDisk 3.5, as well as on the 5 1/4" disk. Its huge vocabulary—80,000 words in all—is derived from the official Random House Dictionary®.

Used in conjunction with a memory expansion card, the improved Sensible Speller runs up to three times faster than before. You can also load everything—program and dictionaries—on to a hard disk drive.

However, Sensible Speller is still just as easy to use. It shows you misspellings in context, suggests the correct spelling, and allows immediate replacement of misspelled words with correct ones.

Chances are you are already equipped to use Sensible Speller because it works with AppleWorks and virtually all other Apple word processors.* It runs on all Apple //c, //e and II+ computers and is available at your dealer for \$125.

Black's Law Dictionary™, **Sensible Technical Dictionary™** and **Stedman's Medical Dictionary™** are available separately on diskette for use with the Sensible Speller. Each is \$39.95. A new utility now allows you to merge the dictionaries together.























*Sensible Speller ProDOS works with the following word processors, AppleWorks, AppleWriter-ProDOS version (Apple Computer, Inc.), Format II Enhanced-ProDOS (Kensington Microwave), Mouse Write-text files (Roger Wagner Publishing), MouseWord (International Solutions), PFS:WRITE-ProDOS (Software Publishing, Inc.), Word-Talk (Computer Aids) and WordPerfect (SSI Software), Word Juggler (Quark, Inc.), Writing Wizard (Scarborough Systems), Zardax-ProDOS (Computer Solutions), and others. Owners of trademarks indicated in parentheses: Black's Law Dictionary (West Publishing, Inc.); Stedman's Medical Dictionary (Waverly Press, Inc.).



Sensible Software, Inc. 210 S. Woodward, Suite 229, Birmingham, MI 48011
(313) 258-5566

CIRCLE 106 ON READER SERVICE CARD



MAKES ADDITIONS TO MAIN DICTIONARY	CREATES PERSONAL DICTIONARY	DISPLAYS SUSPECT WORDS IN CONTEXT	SUGGESTS SPELLING	SCROLLS DICTIONARY	WILD-CARD CHARACTERS FOR SEARCHING DICTIONARY	REQUIRES	OPERATING SYSTEM	UNIDISK 3.5 ALSO
						Apple II Plus, IIe, or IIc	DOS 3.3	
	 2 disk drives recommended					Apple IIe with 128K RAM, or IIc	ProDOS	
						Apple II Plus with 64K RAM, IIe, or IIc; CP/M card	CP/M	
						ProDOS: Apple IIe with 128K RAM, or IIc DOS 3.3: Apple II Plus with 64K RAM, IIe, or IIc	DOS 3.3 and ProDOS	
	 2 disk drives required					Apple IIe with 128K RAM, or IIc, 2 disk drives recommended	ProDOS	

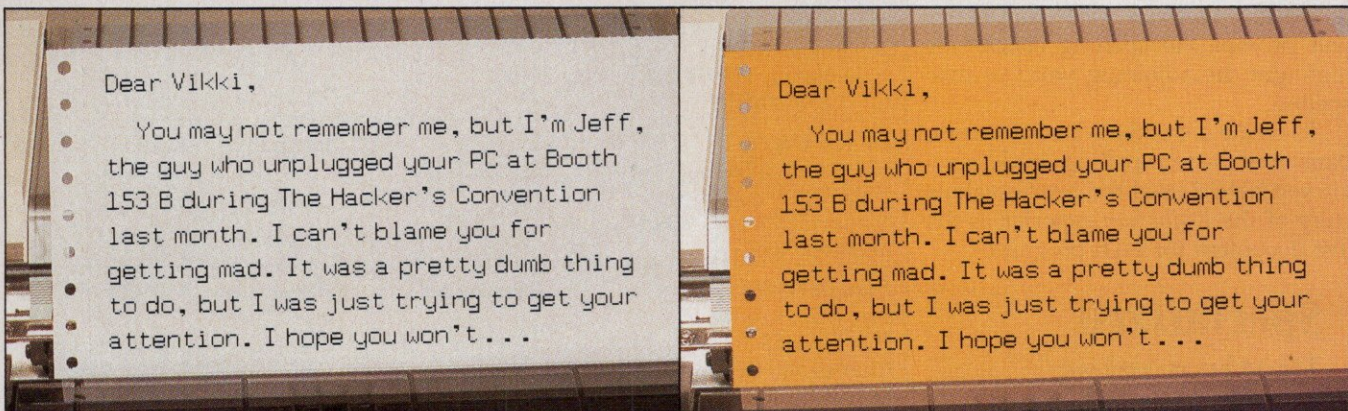

When white ain't right.

A printout is a printout, right? Well, yes and no. TV is TV, too, but you'd rather watch it in color than in black and white. Then why settle for plain old white computer paper? Now you can print out your letters, memos, greeting cards

in any of *nine* vibrant colors on new RainbowPak paper. Color gets attention, creates a mood, adds a powerful extra dimension to your message. When white's not right, say it in color with new RainbowPak.

Say it in color with RainbowPak.

For the name of your nearest dealer, call 800-638-7563.



RainbowPak

Manufactured by:
Eastern Software Distr., Inc.
Baltimore, MD.

cal terms (see listing below).

If you need to create a separate dictionary disk, you will likely require two disk drives. Two disk drives are essential anyway if you don't want to waste a lot of time switching back and forth between your document and stand-alone spelling checkers as you work your way through the correction process.

Occasionally, all writers encounter a word that completely stumps them. Some spelling checkers offer a way to deal with these mystery words. You can substitute "wild-card characters" for one or more letters of a word you don't know how to spell. The program then searches the dictionary for similar words containing the letters you do know, in the same relative position. Think what you could do with cross-word puzzles!

In addition, spelling checkers provide you with useful statistics on your documents. Most give you a total word count, a list of the unique words and how many times each word appears, the number of "suspect" words, and the number of corrections you made. If you plan to embed commands in your document, in most cases you must do so after you've corrected it. Otherwise, your commands will prompt the spelling checker to highlight the adjoining word as misspelled.

To create a standard basis for comparison of the ten spelling checkers reviewed here, I used the heartbreaking story of the *Daily Sun* reporter as the test document for each program.

Specialized Dictionaries

Legal Dictionary

8,000 words, \$85
Quark Incorporated
2525 W. Evans, Ste. 220
Denver, CO 80219
(303) 934-2211, 934-0784 after 2 P.M.

Stedman's Medical Dictionary

65,000 words, \$39.95

Sensible Technical Dictionary

22,000 words, \$39.95

Life Science

22,000 words, \$39.95

Physical Science

25,000 words, \$39.95

Sensible Software, Inc.
210 S. Woodward, Ste. 229
Birmingham, MI 48011
(313) 258-5566

WORD-PROCESSING PROGRAMS WITH

Spelling Checkers

PRODUCT	COMPATIBLE WITH	TYPE	PRICE	# WORDS IN DICTIONARY
The Bard's "Pro-Am" Apple IIe/c Writing System Writing Software International 110 E. Broadway, Ste. 600 Missoula, MT 59802 (406) 543-3141	The Bard's "Pro-Am" Apple IIe/c Writing System	Integrated	\$69.95	50,000
Better Working Word Processor Spinnaker Software One Kendall Square Cambridge, MA 02139 (617) 494-1222	Better Working Word Processor	Integrated	\$59.95	50,000
Home Word Plus Sierra On-Line P.O. Box 485 Coarsegold, CA 93614 (209) 683-6858	Home Word Plus	Integrated	\$69.95	35,000
Mouse Write V.2.6 Roger Wagner Publishing, Inc. 10761 Woodside Ave. P.O. Box 582 Santee, CA 92071 (619) 562-3670	Mouse Write V. 2.6	Integrated	\$149.95	60,000
Perfect Writer Thorn EMI Computer Software, Inc. 285 Millrose Road Chelmsford, MA 01824 (617) 256-3900	Perfect Writer, any ASCII file	Integrated	\$139	50,000
PFS:Write Software Publishing Corp. 1901 Landings Drive Mountain View, CA 94043 (415) 962-8910	PFS:Write, any ASCII file	Integrated	\$125; upgrade, \$35	75,000
ScreenWriter II Sierra On-Line P.O. Box 485 Coarsegold, CA 93614 (209) 683-6858	ScreenWriter	Stand-Alone	\$129.95	38,000
Word Juggler Quark Incorporated 2525 W. Evans, Ste. 220 Denver, CO 80219 (303) 934-2211 (303) 934-0784 after 2 P.M.	Word Juggler	Integrated	\$99	50,000
WordPerfect V.1.0 WordPerfect Corporation 288 West Center Street Orem, UT 84057 (801) 227-4370	WordPerfect	Integrated	\$179	50,000+
WordStar Professional MicroPro International Corporation 33 San Pablo Road San Rafael, CA 94903 (415) 499-1200	WordStar Professional	Integrated	\$495	65,000

MAKES ADDITIONS TO MAIN DICTIONARY	CREATES PERSONAL DICTIONARY	DISPLAYS SUSPECT WORDS IN CONTEXT	SUGGESTS SPELLING	SCROLLS DICTIONARY	WILD-CARD CHARACTERS FOR SEARCHING DICTIONARY	REQUIRES	OPERATING SYSTEM	UNIDISK 3.5 ALSO
						Apple IIe or IIc	DOS 3.3	
						Apple II Plus, IIe, or IIc	DOS 3.3	
	No, part of main dictionary					Apple IIe with 128K RAM, or IIc	ProDOS	
	 2 disk drives recommended		 up to 10	Main, no; personal, yes		Apple IIe enhanced or IIc	ProDOS	
	 2 disk drives recommended					Apple IIe or IIc	DOS 3.3	
				Main, no; personal, yes		Apple IIe with Extended 80-Column Card, or IIc	ProDOS	
						Apple II, II Plus, IIe or IIc; 48K RAM, 128K RAM recommended	DOS 3.3	
						Apple IIe with 128K RAM, or IIc	ProDOS	
	 2 disk drives required					Apple IIe with 128K RAM, or IIc; 2 disk drives recommended	ProDOS	
						CP/M card	CP/M	

*No spelling checker
can take the place of a
good human proofreader
for complete accuracy.*

Bank Street Speller

Designed to work exclusively with Bank Street Writer, this program, like the word-processing program, is ideal for families with young students. The spelling checker is easy to use and consists of a single disk with the program on one side and a dictionary of more than 30,000 words on the other. Bank Street Speller lets you assign passwords to your text files.

As with most spelling checkers, when you boot it and load your text file, the program tells you how many words your document contains and how many of those words are not in the program's dictionary. It also lists all the unique words in your document by letter, tells you how many times each word appears in the document, and prints the list. Educators will appreciate this feature for language study.

As you encounter each highlighted word in your document, the program gives you the option of ignoring it and going on, replacing it, getting a suggested spelling, adding it to the dictionary, or searching the dictionary. Ignoring words is an option in all spelling checkers because they highlight words such as proper names, addresses, jargon, and unusual words that are correct but not in the spelling-checker dictionaries. If you plan to use those words often, you can add them to the dictionary.

Bank Street Speller incorporates the valuable wild-card option. Referring to the sample document, let's say I have no idea how to spell *garanteed* correctly. The suggested spellings are no help, so I type in *g=====teed*, using *=* as my wild card. The program gives me the correct spelling, *guaranteed*.

Two disk drives make life with Bank Street Speller a lot easier and are an absolute necessity for making your own dictionaries on separate disks.

The Bard's "Pro-Am" Apple II/c Writing System

Integrated with a new, multilevel word-processing program (which, by the way, looks quite interesting), The Bard's spelling checker contains a 50,000-word dictionary. You can add

words to this dictionary, but you can't create your own dictionaries on separate disks.

The program suggests alternative spellings and lets you scroll through its dictionary to find words, but it lacks a wild-card option.

The Bard's Insert Mark option lets you mark words or phrases with an asterisk. Then, using the Find feature of the word-processing program, you can locate those marks to make changes you can't make with the spelling checker activated.

When making corrections, you can either type in the new word or choose

from one of the suggested spellings and press Return. The new word automatically replaces the incorrect one, with any capital letters or punctuation automatically substituted.

Better Working Word Processor

Better Working, a word-processing program with built-in spelling checker, highlights suspect words in your document that it doesn't find in its 50,000-word dictionary—but it stops short right there.

Although you do have the options of ignoring, changing, and adding words to the dictionary, you must come up with the correct spelling

On the Horizon

I was able to get only preliminary versions of two of the spelling checkers I tested. By the time you read this article, they should be available in final form. Try to find a dealer that will let you test the software before you make a buying decision.

Pinpoint

Designed for installation as a Pinpoint desk accessory in AppleWorks, the Pinpoint spelling-checker dictionary contains 50,000 words. Installation of the program was tricky.

Once I was in AppleWorks, however, the spelling checker was very easy to use, even more uncannily accurate at coming up with correct spellings for my errors than the PFS:Write program was. Like the PFS:Write spelling checker, Pinpoint does not give you the option of scrolling through its dictionary. You can make additions to the dictionary, however, and create your own dictionaries as text files. Before you quit your document, the program gives you a summary of the number of words in your document, the number of suspect words, the number of corrections it has made, and the number of words you've added to the dictionary. One handy feature: When you install Pinpoint's spelling checker, the installation program asks you to specify which version of AppleWorks you're using and reformats accordingly.

Spellbound

If you're willing to spend some time personalizing a spelling checker to fit your needs, then Spellbound may be for you.

This spelling checker is unique.

Designed to work exclusively with AppleWorks in real time—in other words, as you are typing your document—the program uses a beep to alert you to an error.

Spellbound's dictionary comprises 1000 words that the publisher has determined to be the most frequently used and misspelled words in the English language. So, until you've spent time creating your own personal dictionary, Spellbound is useful only as a typo catcher.

The program caught minor slips such as *was t* for *wasn't* (but not *wasnt*), *gong* for *going* and *cty* for *city*. It did not catch any of the major misspellings in the sample document, however.

According to the publisher, Spellbound is programmed to catch only these four types of spellings errors, which, he has determined, represent 90–95% of all spelling errors: the use of the wrong letter, the insertion of an extra letter, the omission of a letter, or the transposition of two letters. If your error does not fit into one of these categories, you're stuck with it. The program features a special Autopilot option, which, when activated, automatically replaces misspelled words while you charge on with your typing.

Although Spellbound represents a unique concept, if your needs are complex and you produce long documents with many different words, the program is not powerful enough to meet those requirements. The version I used was erratic, and I would not want to have to rely on Spellbound if my life depended on producing a perfectly spelled document.

*Sensible Speller rates
very high as a
valuable writer's
tool.*

without any assistance from the program. It gives you no suggested spellings, and the program lacks the capability of scrolling through its dictionary to look for possibilities. So you must use a printed dictionary to find the correct word, type it into a box at the bottom of the screen, and press Return to substitute the correct word for the misspelled one.

PFS:Write

Integrated with the PFS:Write word-processing program, the PFS spelling-checker dictionary is fixed at 75,000 words, and you can create as many personal dictionaries as you need. Each personal dictionary can contain up to 200 words, and you can save them to separate disks. These personal dictionaries are treated as Write documents, so you can delete and add to them as easily as you can to any other document.

This spelling checker was uncannily good at coming up with the correct spellings of the misspelled words in the sample document, a real tribute to the language skills of the designers. This ability is especially important because you do not have the option of scrolling through the electronic dictionary. So if you don't find the correct spelling for your word listed in the alternatives, you must search through a printed dictionary.

The program automatically replaces capitals and punctuation, catches words typed twice, and prompts you if you try to replace a misspelled word with another word not in its dictionary.

A unique feature gives you the option of checking just one word in a document, which you choose by positioning the cursor and pressing open-apple-X. An interesting aside: The only suggested correction for *turth* in the sample document was *tush* (a long pointed tooth, or Yiddish for but-tocks).

Sensible Speller

If your word-processing program stores its files by using Apple's PRO-DOS operating system, then this latest and most powerful version of Sensible Speller will work for you (see "Sensible Grammar" for a brief look at a use-

ful companion program). It works with AppleWorks, Apple Writer (Pro-DOS), Word Juggler, and MouseWord.

The spelling checker includes a fast and easy utility that you use to customize the program to work with your word-processing program. The package includes a program disk and an 80,000-word dictionary disk. You have the option of adding words to the main dictionary or creating your own dictionary disks. The program gives you a total word count for your document, as well as the number of unique words and the number of times each word appears.

When you begin correcting, your options are to add the highlighted word to the dictionary, ignore it, request a suggested spelling, look the word up in the program's dictionary, mark the word so you can find it later with the word processor, or correct the word by typing in a replacement.

The program allows you to scroll through its dictionary and also to use wild-card characters. Sensible Speller has two handy additional features. You can set it up to ignore characters such as embedded commands, acronyms (such as USA), and numbers. The program can also list all the words you've modified during the correction process with the new spellings listed opposite them. If you're a chronic misspeller, these lists can be quite helpful in curing your affliction. In fact, Sensible Speller rates very high as a valuable writers' tool, and I strongly recommend it to professionals.

Spellworks

For use with AppleWorks exclusively, Spellworks contains a 90,000-word dictionary. The program has some major drawbacks, however. Spellworks is the only spelling checker in this group that doesn't display your misspelled words in context. It does display the words alone on the screen in the order they appear in your document or saves them to a Misspell file on your AppleWorks document disk. You must then return to AppleWorks and open the Misspell file, where the words are displayed in alphabetical order.

The inconvenience of this method is obvious. In order to make your corrections, you must manually compare your printed document to the list, look up the correct spellings in a printed dictionary, and then go back and make corrections. Furthermore, Spellworks doesn't help you find the correct spellings.

**Protect
the fruits of
apple!**

Call (800) 847-4176

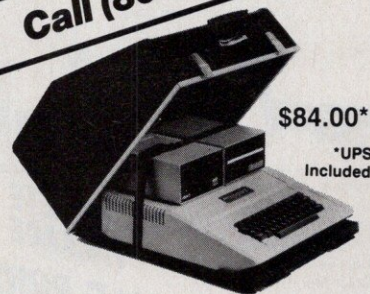

\$84.00*

*UPS Included.

**IIe Foam Padded Carrying Case
with
Removable Cover**

**Macintosh
Carrying Case
\$114.50***

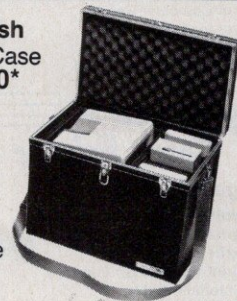

**MacPlus
Flight Case
\$250.50***

*UPS Shipping Included.

shoulder strap
\$.25

IIc Foam Padded Flight Case



Holds: IIc, monitor
w/stand, external
disc drive, power
pack, mouse.

\$189.50*

*UPS Shipping Included.

**Call for Complete
Computer Case Catalog.**

For
Fast
Service!



CREDIT CARD CUSTOMERS
CALL TOLL FREE
800-847-4176
(outside N.Y. State)



Fiberbilt
CASES, INC.

601 West 26th Street
New York, New York 10001-1199
(212) 675-5820 (N.Y. State only)
(800) 847-4176 (Toll Free)

CIRCLE 164 ON READER SERVICE CARD

World of Computers
SINCE 1977
CDA WORLD OF COMPUTERS

NO SALES TAX COLLECTED!
(N.J. Residents add 6%)

Apple IIe Color System

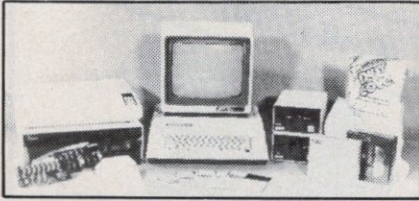

- Apple 128K Enhanced CPU
- Apple UniDisk 5 1/4" Drive
- Apple Second UniDisk 5 1/4" Drive
- Apple UniDisk Controller
- Apple Utilities with ProDOS
- Apple Color Monitor
- Maxell Diskettes (Box of 10)
- Epson LX-80 Printer 100 CPS
- Epson Adjustable Tractor Option
- ALS Printmate Printer Interface
- Thirdwave Lucite Printer Stand
- Package of Computer Paper
- Dust Cover for Computer
- Dust Cover for Printer

COMPLETE PACKAGE
SALE PRICE
\$1799.00
SAVE OVER
\$475.00
suggested list price \$2299.00

Imagewriter II
Color Printer Package

Package Includes:

- Imagewriter II Color Printer
- Imagewriter Ribbon-Black
- Imagewriter Ribbon-Color
- FingerPrint Plus Printer Interface
- Printer Interface Cable
- Thirdwave Lucite Printer Stand
- Printer Dust Cover
- Package of Computer Paper

SAVE OVER
\$250
SALE PRICE
\$575.00
suggested list price \$839.00

FEATURED ITEMS

Listed below is just a sampling of our massive product line and incredible prices - please call for pricing on items you don't see listed!

APPLE COMPUTERS		MODEMS	
Color Monitor IIe	\$399	Hayes Micromodem IIe	199 \$149
Super Serial Card	139	Hayes Smartmodem	239 169
UniDisk		300/IIc	
5 1/2" Drive	279	Hayes Smartmodem	
Unidisk 3.5		1200 Mac	649 439
w/catalyst	529	Prometheus 1200M Ma	549 339
Unidisk 3.5		Prometheus 1200A IIe	449 259
controller	69	Prometheus 300C IIc	119 89
128K CPU Only	945		
	699	DISK DRIVES	
		Accorn 1/2 height IIe	\$199 \$99
		Accorn 1/2 height IIc	199 105
		IMI full height IIe	239 169
		Gamma 1/2 height IIe	199 149
		Gamma 1/2 height IIc	199 149
		AST RESEARCH	
		SprintDisk 256K	\$299 \$199
		SprintDisk 512K	349 239
		SprintDisk I Meg	399 299
APPLIED ENGINEERING			
Ramworks II 128K	\$199 \$149		
Ramworks II 256K	219 179		
Ramworks II 512K	269 209		
Ramworks II			
1 Meg	369 269		
Transwarp			
Accelerator	279 229		

ORDER TOLL FREE
800-526-5313

IN NJ 201-728-8080
CDA Computer Sales
31 Marshall Hill Road
West Milford, NJ 07480-2193

Order via telephone:
Monday thru Friday 9am to 9pm EST
Saturday 10am to 4pm EST
Order via Compuserve:
Electronic Mail 24 Hours a day!

Order via mail:
Include address and phone #.
Payment: No COD Cashiers checks, Money orders,
Credit Cards ship immediately. Personal and company
checks allow 15 days.

Webster's New World Spelling Checker

The Webster's program is compatible with ASCII text files, Apple Writer II, Bank Street Writer, HomeWord, Magic Window II, PIE Writer, and Screenwriter II. This program offers a 114,000-word dictionary and some unique and time-saving features.

First, it has four different "scan levels" for finding words in its sizable dictionary. If you make few spelling errors and typos, you can use the Manual scan, which rapidly searches the document for errors without suggesting alternate spellings. A Quick scan searches only in the general alphabetic vicinity of the word in question but does suggest alternate spellings. Full scan gives you the most thorough word search and is the most time-consuming. Automatic scan claims to use an artificial-intelligence technique for determining where to

The Webster's program caught more errors than any other spelling checker did.

search in the dictionary, based on the kinds of errors you've made in past documents.

Since I ran only one document through Webster's spelling checker, I can't say how accurate the artificial-intelligence technique is. But I will say that Webster's caught more errors in my sample document than any other spelling checker did, and the program was very good at suggesting the correct spelling. For instance, it was the only program to provide the correct spelling of *sledgehammer*. The program also catches double-word typos, such as *to to*.

Sensible Grammar

Sensible Software, maker of Sensible Speller, offers another writing aid many writers will find useful. Sensible Grammar catches most punctuation and spacing errors and singles out more than a thousand "misused phrases" with speed and precision. Unfortunately, its abilities as a grammar checker are not as extensive as you might wish and possibly never can be, given the complex set of rules that govern English grammar. Sensible Grammar's value simply depends on the types of mistakes you make and how frequently you make them.

Designed to be used with a mouse, Sensible Grammar works just as easily without one. The Check option is the heart of the program. With it you can check your document for punctuation errors, grammar errors, or both. In most cases, you will probably choose both, and when you do, Sensible Grammar loads the punctuation list and each of the error lists that you have selected. Next, you enter the name of the document to be checked, and Sensible Grammar begins its search, sentence by sentence, with a forward and backward motion, as it compares each sentence against its list of possible errors.

To help with the editing process, Sensible Grammar uses a series of

overlapping windows to indicate its location in your document. The rear window, whose left edge is only partially visible, traces the program's movement through the document, while sentences with problems appear in the front window. If the program tags a punctuation error, it offers you the options of ignoring it, marking it, or having the sentence and a description of the error sent to the printer. If it finds a grammatical error, you can also enter a correction or have the program suggest one. Editing continues until you've reviewed your entire document.

Advantages

Sensible Grammar singles out many common typographical errors, including words that have accidentally been typed twice in a row; single occurrences of brackets, quotation marks, or other punctuation marks normally used in pairs; and incorrect or inconsistent spacing adjacent to punctuation marks. It can even check to see whether commas are being overused and suggests semicolons as alternatives in some places.

Another group of Sensible Grammar options focuses on word and phrase selection. You can, for example, choose to include complex legal terms in your document or have them translated into simple English. Simi-

In addition, the Webster's program automatically replaces capital letters and punctuation and catches errors you make when you are typing replacement words. I highly recommend this program to professionals who demand high standards of accuracy in their writing.

WordPerfect

From the powerhouse of word-processing programs comes the added feature of an integrated spelling checker. The WordPerfect program contains a dictionary with more than 50,000 words and the option of adding more. You can create your own dictionaries if you have two disk drives.

The program gives you suggested spellings for words in your document it doesn't find in its dictionary, and you have the option of scrolling through the dictionary. Wild-card characters give you added leverage for

word searches, and the program alerts you if you type in a misspelled replacement word. It also spots double-word typos.

The spelling checker is a worthwhile addition to the king of word-processing programs, and you can upgrade your copy of WordPerfect to add the spelling checker for only \$30.

Cast a Spell

Spelling checkers add significantly to the advantages writers have already gained with word-processing programs. Although they are not a replacement for careful proofreading, if you're willing to spend the time required to run your documents through a spelling checker, you can be sure you'll get a much higher degree of accuracy in your work.

Susan Janus, a frequent contributor to A+, is a free-lance writer working in the San Francisco Bay Area.

larly, contractions can be bypassed or changed into more formal English. Sensible Grammar also recognizes and corrects word groups that should be written as single words (e.g., *every thing, can not*) and vice versa (e.g., *alot* should be *a lot*).

The last feature is a wordy-phrase checker with a list of over a thousand awkward phrases and their alternatives, and although Sensible Grammar cannot detect disjointed thinking, the faulty phrases and superfluous words it identifies are often associated with such thinking. Replacing these phrases may clear up enough of a sentence's meaning to make additional editing simpler.

Disadvantages

Despite Sensible Grammar's capabilities, some people will find the program too limited. It cannot find misplaced words, poor sentence structure, or verbs in the wrong tense—each one of which is a violation of good grammar. A document you proofread with Sensible Grammar will still require careful reading before you can consider it error-free.

To use Sensible Grammar with a word-processing program, you must save your document as a text file, print out the corrections, and then enter each change individually with your word-processing program.

Sensible Grammar comes on a protected disk, thus leaving users dependent on Sensible Software for

backups. Sensible Software has plans, however, to provide a flow of updates. The manual is simple and well written—it keeps its promise of having you running the program in 15 minutes.

Individuals who have few problems with their writing or who are effective proofreaders will have little need for Sensible Grammar. If you are among the remaining majority, though, Sensible Grammar may be a useful tool for you.

John Heroy

PRODUCT INFORMATION

Sensible Grammar

Sensible Software
210 South Woodward
Suite 229
Birmingham, MI 48011
(313) 258-5566

List Price: \$99.99 (includes manual and 5¼- and 3.5-inch disks)

Requires: Apple IIe with an Extended 80-Column Card, or Apple IIc; monitor capable of displaying 80-column text; Disk II, DuoDisk, UniDisk, or UniDisk 3.5 disk drive

Works With: AppleWorks, Apple Writer, MouseWord, and—with some limitations—Formatt II ProDOS, PFS:Write ProDOS, Zardax, MouseWrite, and Word Perfect; all ProDOS hard-disk drives and most RAMdisk drives

CIRCLE 382 ON READER SERVICE CARD

DISK SALE!

PREMIUM QUALITY! LIFETIME WARRANTY!

WE DON'T SELL FANCY NAMES, BUT WE SURE SELL THEIR DISKS!

When you buy a name-brand disk, you pay for more than just the disk, you pay for fancy advertising, fancy packaging. But when you buy a UNITECH disk, you get a PREMIUM QUALITY, HIGH RELIABILITY, fully guaranteed disk. Identical to disks that sell for many times our price! When you buy a more expensive diskette, you aren't necessarily buying a better product.

33¢

WHO MAKES UNITECH DISKS?

They are made by top USA makers, and should not be confused with low-end or second-hand. Since we are one of the largest disk buyers in the world, the manufacturers give us their best prices! In our agreements with the manufacturers, we can't reveal their names, but when you receive them you'll recognize these as among the highest-quality disks made.

GREAT PRICE AND HIGH QUALITY!

We've tried almost every brand of disk, but we haven't found a more reliable, higher quality disk than the Unitech Disk. Unitech is so sure that our disks are 100% perfect that we offer our famous UNCONDITIONAL 30 MONEY-BACK SATISFACTION GUARANTEE, AND OUR LIFETIME REPLACEMENT WARRANTY!









PROPERLY PACKAGED & SAVED!

You can buy Unitech disks BULK (N-Pak) or sleeve or box; BOXED IN TENS (D-Pak) or BOXED IN 25's (2-pak) with labels, sleeves, boxes, and tabs. Add 2¢ per disk for D-pak. UD3's are poly bagged. Specify type when ordering.

GREAT PRICES ON DISKS FOR THE APPLE!

Prices are per disk	BULK					BOXED				
	100	500	1K	5K	10K	25	100	500	1K	5K
For the Apple II, II+, IIc, IIc #UDA	45¢	42¢	39¢	36¢	33¢	58¢	53¢	50¢	47¢	44¢
SS/DD for single side computers #UD1	50¢	47¢	44¢	41¢	38¢	63¢	58¢	55¢	52¢	49¢
DS/DD for IBM-PC and compatibles #UD2	55¢	52¢	49¢	46¢	43¢	68¢	63¢	60¢	57¢	54¢
DS/Quad Density (960bit) #UD4	1.09	1.04	99¢	92¢	86¢	1.19	1.11	1.06	1.02	99¢
DS/Hi-Density for IBM-AT #UAT	2.15	2.12	2.10	2.08	1.99	2.40	2.32	2.22	2.20	2.18
3½", single side for Mac #UD3	1.86	1.83	1.80	1.77	1.74	1.89	1.86	1.83	1.80	1.77
3½", double side for Mac & Amiga #UD6	2.65	2.62	2.59	2.40	2.30	2.80	2.70	2.65	2.45	2.40
5¼" SLEEVES, 24# white wave #SLV	5¢	4.5¢	4¢	3.8¢	3.3¢	SPECIFY SUFFIX "A"-"D" WHEN ORDERING DISKS!				
5¼" SLEEVES, white Tyvek #TYV	7¢	6¢	5.5¢	5.2¢	5¢					

GREAT STUFF AT INCREDIBLY LOW PRICES!

 <p>UNIFILE-100 DISK FILE \$13.88 Holds 100 5¼" disks.</p>	 <p>UNIFILE-10 LIBRARY CASES 99¢ Holds 10 disks.</p>	 <p>UNIFILE-70 DISK FILE \$8.88 Holds 70 disks.</p>
 <p>TYVEK SLEEVES White lint-proof tyvek sleeves for 5¼" floppy disks. #TVV 100 for \$7</p>	 <p>UNITECH'S FAMOUS DISCOUNT CATALOG Pages of unbelievably low prices on hundreds of computer supplies! Send for your free copy!</p>	 <p>UNI-NOTCH DISK NOTCHER \$7.77 Cuts diskette prices in half! #N1</p>
 <p>SURGE PROTECTOR Six switched outlets, circuit breaker, full surge protection, 15 amp. #ACPC \$19</p>	 <p>UNIPAK DISKETTE MAILERS Holds three disks! Bend resistant plastic, cardboard, 6x8 #UNIPAK 10 for \$5</p>	 <p>RIGID-PAK 3.5 DISKETTE MAILER CARRIER \$1 Holds 5 disks in brace case or for mailing. Rigid plastic. #RPAK</p>

80 COLUMN +64K RAM CARD FOR APPLE IIe, guaranteed 100% compatible #80COLR 549
64K MEMORY EXPANSION RAMS, type 4164-150, package of 8/\$12 or 9/\$13.50
LETTER QUALITY COMPUTER PAPER, 2500 sheets, 20# microperforated #LQ11 #P \$29
DRAFT QUALITY COMPUTER PAPER, 3300 sheets, 15# stb-perf 8½x11 #DGP \$29
COMPUTER MAILING LABELS, std 5 lines x 3½" #L5 1000 tabs \$19
COMPUTER POWER CABLES, fits Apples, IBM & compatibles #CPC \$2.22
DISK DRIVE DUMMY PANELS, full height #PHP or half-height #HPH \$1 each
256K RAMS, 41256-150 for IBM compatibles \$3.85 each
HEAD CLEANER KIT, cleaner disk & solvent, use up to 15 times! #HCK \$4.95
DB25 GENDER CHANGERS, all pins wired, choose M/M (#MMGC) or F/F (#FFGC) \$7.77
UNTESTED DISKS, returns from a major disk seller, most perfect #DISK 10/53
WRITE PROTECT TABS, silver-colored, 100 tabs \$1.50, 1000 tabs \$12
DB-25 MALE CONNECTORS, solder-type #DB25M \$1.78, 10/516
DB-25 FEMALE CONNECTORS, solder-type #DB25F \$1.78, 10/516
DB-25 HOODS, for above connectors, shatter-resistant plastic #DB25H \$2¢, 10/5740
A/B SERIAL SWITCH BOX, for modems, serial printers #ABSR \$49
A/B PARALLEL SWITCH BOX, switches between 2 printers #ABPAR \$49
FLEX-ARM COPY HOLDER, holds work while typing, with clamp #COP10 \$19
RIBBON CABLE, std .05" IDC spacing, 34 cond \$4.90/10 ft; 25 cond \$2.40/10ft

SUPER QUALITY KRISPE™ RIBBONS!

Brand new, highest quality full-length ribbons, not short-lengths or reloaded. Guaranteed to meet or exceed original manufacturer's specifications.

Call: For the following types of printers:
#PR498 Apple Imagewriter; C Itoh Prowriter 1/2; NEC P8023A; \$4.50ea 12/549.50
#PR180 Okidata 80/81/82/83/83A/92/93; \$2.15ea 12/523.65
#PR193 Okidata 182/183/193; \$7.50ea 12/582.50
#PR470 Epson MX50/RX50/7380; Commodore 4022/8022; \$4.50ea 12/549.50
#PR610 Panasonic KXP1090/1091/1092 \$9.49ea 12/5104.39
#PR479 Radio Shack LP6/LP8; Panasonic KXP1093; \$5.50ea 12/560.50
#PR494 Commodore 801 \$5.80ea 12/563.80
#PR495 Commodore 803 \$5.80ea 12/563.80
#PR478 Commodore 1525 \$7.50ea 12/582.50
#PR180 Commodore 2022/2023; Gemini 10/15/15X; \$2.15ea 12/523.65

SHOP WITH CONFIDENCE: Unconditional 30 day money-back guarantee on all items! Unitech disks also carry a lifetime replacement warranty!

HOW TO ORDER: Pay by MC-Visa-Amex-CDD, or send check with order, (minimum order \$20, add \$3 for shipping; \$22 COD. PAPER SHIPPING: zips 0-2 \$3/ctz; zips 3-6 \$5/ctz; zips 7-9 \$8/ctz. (We can ship account to schools with good credit, minimum purchase order \$100. FOB UNITED STATES.) All orders must include daytime phone and STREET address. MONEY-BACK 30 DAY SATISFACTION GUARANTEE. SEND FOR FREE CATALOG LISTING 100'S OF DISCOUNT COMPUTER SUPPLIES!

UNITECH
IN MASS (617) UNITECH
20-A HURLEY STREET
CAMBRIDGE, MA 02141

(800) 343-0472

CIRCLE 160 ON READER SERVICE CARD

Videx TimeWand™

Keeping Track Of Time With AppleWorks™

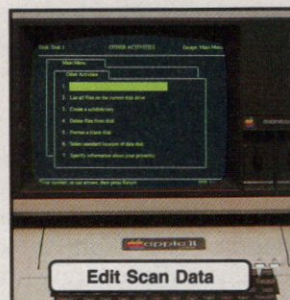
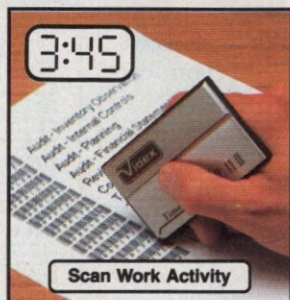
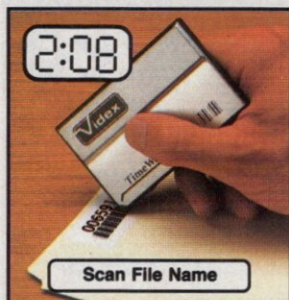

The Videx TimeWand is an intelligent yet inexpensive bar code reader that can simplify your business operations. Small enough to fit into a shirt pocket and weighing less than two ounces, TimeWand gives a new dimension to the concept of a fully portable bar code reader.

As its name implies, TimeWand does more than just read bar codes, it also time-stamps each bar code as it is read. This powerful feature allows you to use the TimeWand to streamline a variety of applications such as asset control, material tracking, client billing, and maintenance control to name just a few. TimeWand is a versatile tool that can help you collect and process a wide range of business information.

TimeWand Communication Software

The Apple // Communication program performs many of the basic software tasks needed for working with the TimeWand. It transfers the bar codes out of the wand and stores them to disk, reformats the data on disk so that you can use AppleWorks to create reports, and programs the wand to read different types of bar codes. The Communication program requires an Apple //+, //e, or //c with a minimum of 64K of memory and a ProDOS compatible clock.

TimeWand Apple // Starter Kit \$445

Includes 2K TimeWand, Recharger, Cable, and Software.

AppleWorks on Your Apple][+

Videoterm™ and UltraTerm 80-column card owners can now use the popular AppleWorks program on their Apple][plus. **AppleWorks Modify Plus** is a software package, from Videx, that replaces the startup disk for AppleWorks, allowing this powerful integrated program to run on an Apple][plus!

AppleWorks Modify Plus \$59

To use AppleWorks on your Apple][+ you will need the following:

- AppleWorks Modify Plus disk from Videx.
- AppleWorks disks: version 1.1, 1.2, or 1.3 from Apple.
- An Apple][+ with a minimum of 64K of memory*
- The "one-wire" shift key modification installed in your Apple][+.
- A Videoterm (with inverse) or UltraTerm** display card in slot 3 of your Apple][+.

* Extra memory cards are supported depending on the version of AppleWorks you are using. Call Videx for details.

** Only Videx 80-column cards are guaranteed for use with AppleWorks Modify Plus. The UltraTerm works in 80 x 24 line mode, non-interlaced video.

Videx is a registered trademark of Videx, Inc. TimeWand and Videoterm are trademarks of Videx, Inc. AppleWorks is a trademark of Apple Computer, Inc.



UltraTerm \$149

Factory direct at half price. Limited time only.

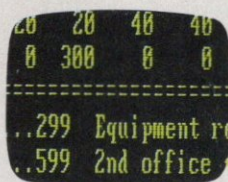

Photo of actual-size characters from an Ultraterm on an Apple Monitor III

Call Videx today to discover new ways to use your Apple][plus!



1105 N.E. Circle Blvd.
Corvallis, OR 97330-4285
(503) 758-0521

COMMUNICATE BETWEEN COMPUTERS...

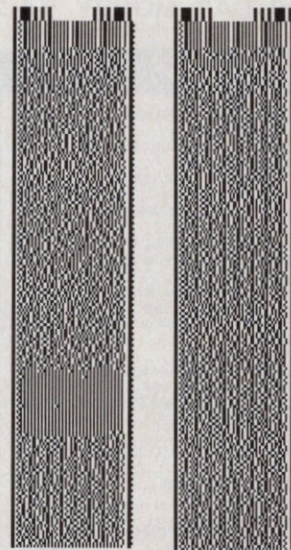

ON PAPER

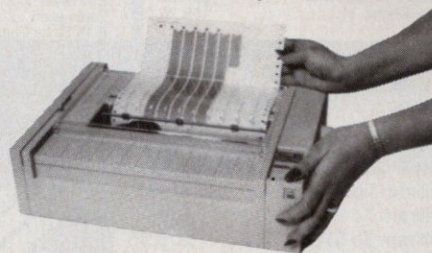

RED2BLUE.COM
Conversion Program

READTHIS.TXT
INSTRUCTIONS

Use Mac or Apple files on a PC? Difficult? Not with the revolutionary Cauzin Softstrip™ System. With it you can easily move data between incompatible computers. Transfer ASCII or binary, word processing, data base or spreadsheet files. Mac to PC. PC to Mac. Apple to PC. And back again.

Picture a complete system. One that provides a simple and reliable way to distribute and retrieve information. Anything you can put on a magnetic disk, you can put on a Softstrip data strip. Facts. Figures. Software programs. Video games. Product demonstrations. Sheet music. And the list goes on.

A new industry standard, Softstrip technology, has rapidly changed the shape of computer software. You've probably already noticed the change on the pages of leading magazines. Data Based Advisor. MACazine. Nibble mac. MacUser. // Computing. Keyboards Computers & Software. These are just some of the growing ranks of publications featuring programs and data editorially in a form you can scan right into your computer — without typing!

But that's just the beginning of the Softstrip story and the real art of stripping . . .

How can you take an Apple file and read it into a PC word processor?

- Enter your document in DOS 3.3 AppleWriter, or convert a ProDOS AppleWriter file to DOS 3.3, or save an AppleWorks file as ASCII and convert it to DOS 3.3.
- Print your file as strips using Apple STRIPPER™.
- Read the strips into the PC with the Softstrip reader.
- Follow directions contained in READTHIS.TXT (strip above, right).
- Run "RED2BLUE" (strip above, left) to convert the Apple file for your PC word processor.

TECH SPECS

The Reader is lightweight and portable. It comes complete with all the software and cables you should need to connect it to your PC; Apple II series; or Macintosh computer. It has its own power supply and connects to standard RS232 ports (or to the Apple //e cassette port).

ALL YOU NEED TO START STRIPPING . . .

besides your computer, a Softstrip reader, and STRIPPER™ (the "make-it-yourself Softstrip data strip program"):

FOR IBM PC or 100% COMPATIBLE OWNERS

Epson RX or FX printer
Printer interface card

FOR APPLE II OWNERS

Epson RX or FX printer, or
Apple Imagewriter I or II, and,
Super Serial™ card (built into Apple //c), or,
Grappler™ graphics card, or,
Dumpling™ graphics card.

FOR MACINTOSH OWNERS

Apple Imagewriter I or II

You can buy the Softstrip System for only \$199.95 (STRIPPER™ is only \$19.95 and an extra accessory kit is also only \$19.95) at all better computer stores. For the one nearest you, or to order direct, (if there is no dealer in your area) call: 1-800-533-7323 in Connecticut: 203-573-0150.

Dumpling is a trademark of Microtek, Inc.
Grappler is a trademark of Orange Micro, Inc.
Epson is a registered trademark of Epson America, Inc.
Macintosh is a trademark of McIntosh Laboratories, Inc. and is licensed to Apple Computer, Inc.
Apple is a registered trademark and Imagewriter, Image Writer II, and Super Serial Card are trademarks of Apple Computer, Inc.

IBM is a registered trademark of International Business Machines Corporation.
Softstrip and STRIPPER are trademarks of Cauzin Systems, Inc.

Cauzin Systems, Inc.
835 South Main St., Waterbury, CT 06706

Computer Network

CALL TOLL FREE 1-800-621-0937

10 DAY MONEY BACK 100% SATISFACTION GUARANTEE ON ANY HARDWARE PRODUCT
 In 10 days of receipt we will refund your money if you're not 100% satisfied with any Hardware Product shipped to you, (less shipping).

BUSINESS

ASCII Express ProDOS/DOS	ea	82.00
Bank Street Mailer		40.99
Bank Street Writer 64K/128K	ea	40.99
Bank Street Speller		40.99
Bank Street Filer 64K/128K	ea	40.99
BPI GA,AR,AP,PAY Pro		221.00
Bookends ProDOS-2C/2E-128		67.00
dBase II (Req CP/M 80)		289.00
Dollars & Sense (II+/IIe)		56.50
Dollars & Sense (IIc/IIe-128k)		66.50
Fontrix		63.00
Market Analyzer (Dow Jones)		219.00
Sales & Management Edge	ea	139.00
Format II Enhanced 64K or 128K	ea	86.50
Flashcalc		45.00
Manage Your Money		102.00
MouseWrite 2C/E-ENH 128		72.00
Merlin Pro 2C/2E-128K		64.95
PFS 1st Success F/R/W Pro-128K		126.00
PFS File & Report	ea	68.50
PFS: Graph		68.50
PFS Write ProDOS-2C/2E-128K		68.50
ProFILER		65.00
Real Estate Analyzer III	CALL	
Sideways Pro DOS	CALL	
Sideways Dos 3.3		32.00
Supercalc 3a 2C/2E ENH		99.95
The Handlers Package		95.00
The Graphics Department		65.00
Think Tank		84.95
Word Perfect		115.00
Wordstar Professional		227.00
Word Juggler III		159.95

APPLEWORKS

Appleworks II+ Modifier 128k.	47.95
Graphworks	55.95
HabaMerge	48.50
Haba Templates	19.95
Jeeves (REQ Clock)	34.95
MacroWorks New!	22.95
Megaworks	73.40
Pinpoint 2C/2E-ENH 128K ProDOS	36.95
Pinpoint Tool Kit	34.95
Pinpoint Pop-up Speller Checker	39.95
Pinpoint Tool Kit	34.95
Quicken (New)	52.95
Reportworks	73.40
Sensible Speller DOS or ProDOS	ea 73.30
Sensible Grammar	79.95
SpellWorks	29.95
Speedemon	175.95
ThinkWorks (New)	CALL

HOME-HOBBY

Bag of Tricks	29.00
Barron	35.00
Blazing Paddles	34.95
Choplifter	22.89
Copy II	22.50
Crosstalk	109.00
Dazzle Draw (Imagewriter II compat)	35.15
Deadline	28.69
Deluxe Music Construction	37.00
Essential Data Duplicator	49.00
Eagles	27.95
Enchanter	23.69
Fantavision	31.95
F-15 Strike Eagle	20.50

HOME-HOBBY

Flight Simulator II	29.95
GATO	23.75
Graphics Expander Req. Printshop	23.95
Home Accountant	43.95
Hobbit	22.50
King's Quest II VIII (C/E-128K)	ea 29.30
Lode Runner	20.50
Locksmith (OMEGA)	64.00
Millionaire	29.30
Mind Prober	35.15
Movie Maker	30.00
Newsroom +E/C	30.50
Newsroom clip art 1	16.25
One on One	25.50
Pinball Construct	25.00
Printshop +C/E	26.75
Printshop GL 1,2,3	ea 14.25
Printshop Refill	12.25
Printshop Companion	22.50
Sargon III (II, Mac)	29.30
Seven Cities-Gold	25.50
Silent Service	CALL
Skyfox	25.50
Super Zaxxon	19.50
Star Trek-Kobayashi	24.50
Turbo Pascal (Req. CP/M)	35.95
Turbo Toolbox	30.00
Spy vs. Spy	24.95
Shadowkeep	27.49
Summer Games	24.00
Take I	38.89
Ultima III / IV	34.95
Winter Games	24.00
Your Personal NetWorth	50.00

EDUCATION

Early Games for Young Children	16.00
Master Type	23.45
Math Blaster	29.30
Typing Tutor III	29.30
Word Attack	29.30
Speed Reader II	41.00
Mission Algebra	28.00
Turtle Tracks	24.00
Spinnaker Full Line	SCALL
Stickybear ABC/#s/Math/etc	ea 24.00
Where is Carmen San Diego?	24.25
Algebra I thru IV	ea 26.95
Algebra V & VI	34.95
Alphabet Zoo	18.95
Chivalry	32.99
Fraction Fever	17.95
Visible 6502	31.89
Visible Pascal	31.89
Spell It	28.69
Snooper Troops 1 or 2	22.95
Rocky's Boots	31.95
Trains	20.95
Spellcopter	24.00
Understanding Ite	17.95
Charlie Browns's ABC's	29.95
Snoopy's Rescue	29.95
Beneath Apple DOS	16.95
Beneath Apple Pro DOS	16.95
Remember!	46.95
Story Maker	24.50
Alge-Blast (Davidson & Assoc)	34.95
Science Toolkit Master Module	37.95
Turbo Tutor	24.95
Sticky Bear Reading	23.99

CHECKMATE TECHNOLOGIES

Multiram IIe 64k	\$ 118.95
Multiram IIe 320k	165.95
Multiram IIe 576k	205.95
Multiram IIe 768k	237.95
Multiram IIe 64k w/RGB	158.95
Multiram IIe 320k w/RGB	206.95
Multiram IIe 576k w/RGB	244.95
Multiram IIe 832k w/RGB	276.95
Multiram IIe 1 meg w/RGB	308.95
16 bit Microprocessor IIe	159.95
Multiram IIc 256k...CX	179.95
Multiram IIc 512k...CX	239.95
Multiram IIc CX kit 16 bit	139.95
Pascal RAM software	19.95
CP/M RAM software	19.95
256K Ram Chips 150ns	4.50



NEW!

- Apple IIc Compatible
- 85C02 Processor
- Full 128k of RAM
- Built-In 5.25-Inch Disk Drive
- External Apple II-compatible expansion slot
- 10-key numeric keypad
- Mouse and Modem Interface
- Serial & Parallel Interface

Laser 128

\$395

APPLIED ENGINEERING

Ramworks II 64k	\$ 139.95
Ramworks II 320k	187.95
Ramworks II 576k	225.95
Ramworks II 832k	268.95
Ramworks II 1 meg.	295.95
Z-RAM IIc 256k	295.95
Z-RAM IIc 512k	339.95
Veiwmaster (+E)	105.00
Z-80 Plus (+E)	105.00
IIc System Clock	65.00
Timemaster II H.O.	100.95
TRANSWARP (New)	219.00
16 Bit Option for IIc & IIe	69.95
Z-80c card for IIc	114.95
16k Ram card for II+	55.95
Disk Drive IIe	119.00
Disk Drive Controller IIe	67.95

DISKETTES

Elephant SS/DD	9.95
Elephant SS/DD	12.95
Elephant DS/DD	15.95
Verbatim SS/DD	14.95
Verbatim DS/DD	16.00
Diskettes 3 1/2 SS/DD	24.95
Diskettes 3 1/2 DS/DD	29.95
Diskette Cleaner kit 5.25	7.95
Top Notch (Disk Notcher)	9.95
Disk case (holds 10 Disks)	3.00
Diskette Carousel (holds 72) 5.25	15.95
Ring King Binder Files (holds 20)	10.95

Disk Drives

Disk Drive IIe Applied Eng.	119.00
Disk Drive Controller AE	67.95

PRINTERS

Epson LX-80	279.95
Epson FX-85 80 col.	369.95
Epson FX-286 136 col.	589.00
Epson LQ 1000 Ser. & Par.	709.95
Epson LQ 800 Ser. & Par.	579.95

RIBBONS

Imagewriter II Color	9.99
Imagewriter	4.15
Prowriter 8510	4.15
Epson FX/RX 80	4.15
Epson FX/RX 100	5.83
Epson LX-80	5.83
Okidata 192	6.65

OTHER RIBBONS CALL COLOR RIBBONS CALL

HARDWARE

Amdex 300 12"	123.00
Color 300	225.00
Color 600	399.00
RGB Interface	127.00
BusinessCard	145.00
Cool + Time	69.00
Grappler +	72.00
Serial Grappler	79.00
Buffered Grappler + 16K	131.50
Hot Link, S-P cable for IIc	44.00
Grappler C	75.00
A-B switch Box 25pin	59.95
A-B Switch Box 36pin	99.95
Muppet Keys	44.00
Muppet Touch Tablet	75.00
Koala Pad IIe - IIc	75.00

HARDWARE

Trackhouse non/prog.	87.00
Trackhouse programmable	127.00
UltraTerm 132 Col. (II+/IIe)	179.00
Mach III w/Fire (II+/IIe)	32.25
IIe 80Ram Card	62.95
System Saver	62.00
The Cricket IIc	111.00
Thunderclock +	103.00
Disk Notcher	9.95
X-10 Powerhouse Interface kit E/C	55.95

MODEMS

Hayes Smartmodem 1200	360.00
Hayes Smartmodem 300	132.00
Micromodem IIe w/Smartcom I	129.00
Hayes 2400 External Modem	577.00

Visa & Mastercard Accepted

***No Sales Tax**

For fast delivery send cashier's check, certified check or money order. Personal and company checks allow 15 days. Shipping - Software (\$3.00 min.). Shipping - Hardware (please call). Sorry No C.O.D.'s. School P.O.'s, Add 3% (\$3 min.). Am. Ex-5%. *NM Res. add 4.75% sales tax. Prices & availability subject to change without notice. All products are new and include factory warranty, therefore all software sales are final. We do not guarantee compatibility. Products purchased in error subject to 15% restocking fee. Defective merchandise replaced with same item only. Foreign add 18% (\$25 min.). Not Responsible for typographical errors. Mail Orders to COMPUTER NETWORK, 3204 NATL. PARKS HWY., CARLSBAD, NM 88220

A CONSTRUCTION SET FOR TEACHERS

Tutor-Tech makes creating instructional software fast and easy.

This January I came across a new "construction set" authoring system for the Apple IIe and IIc computers that deserves a close look by teachers interested in creating instructional software. This product is Tutor-Tech from Techware, Inc.

Tutor-Tech consists of a teacher's disk for creating lessons, a student disk for running them, and an optional grader disk for performing statistical analysis and creating grade reports from data captured automatically during lesson use. These three components are priced separately to allow purchases to be tailored to each classroom's specific needs.

Lessons you create with Tutor-Tech are organized around screens or "pages." Each lesson can contain graphic information as well as text. You ask students questions that they answer by "clicking" buttons (for multiple-choice responses) or by entering text from the keyboard.

Whenever a student clicks a button, the program jumps to a new screen that the teacher has previously chosen to be the destination for that button. Typed responses are analyzed to see if they match a predefined answer. The program then branches to one of two screens, depending on whether or not the student's answer was correct.

This ability to branch quickly through many pages of a lesson makes lesson construction easy. It does require advance lesson planning, however, so the teacher knows which page is the correct destination for each button click.

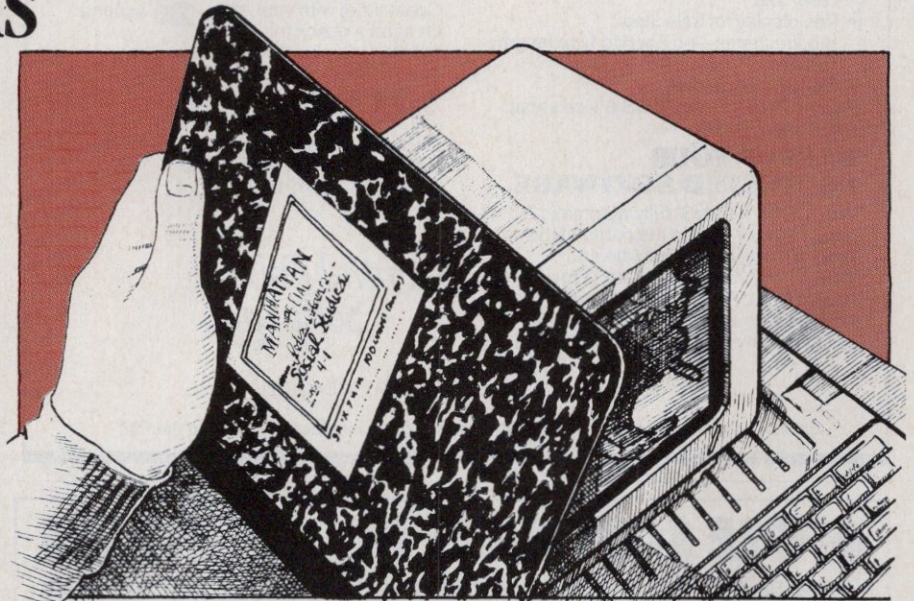

The Tutor-Tech buttons can do more than direct the program to a new screen. Three button types are available: neutral, plus, and minus. When a student clicks a neutral button, the only thing that happens is that a new page appears. A click on a

and paper showing, roughly, what will be on each screen and what should happen when each button is clicked.

Individual lessons can contain 250 pages, assuming you don't run out of memory first. You can build larger lessons from smaller ones by linking them together. This method solves any RAM-space problems that might otherwise occur.

To keep memory requirements to a minimum, Tutor-Tech pictures are built from graphic objects rather than from bit maps. This style of graphics (also found in MacDraw and Filevision, for example) allows the representation of complex pictures in little memory space.

Another Maclike aspect of this product is its use of pull-down menus and the mouse. (The mouse is necessary only for use with the teacher's disk—students can use cursor-control keys instead). The similarity to the Macintosh interface is so close that I was able to use this product within a few minutes of opening the package. Unfortunately, the lower resolution of

Tutor-Tech's main contribution is that it allows teachers to concentrate purely on the lesson itself.

plus or minus button increases or decreases the student's score by one point and causes a jump to a new page. The score for each lesson accumulates automatically, and students can't tell the "value" of a button.

The Authoring Situation

Lesson creation with Tutor-Tech has two stages. The first entails the creation of a storyboard with pencil

COPY II PLUS™



THE BEST, MOST COMPLETE ProDOS-DOS UTILITIES.

- Copy files, disks, even entire subdirectories.
- Undelete ProDOS and DOS files.
- Fast 2-pass disk copy on Apple IIe, IIc or Laser 128.
- Tree display for selecting subdirectories—no need to type lengthy "prefixes."
- Alphabetize catalog.
- Convert DOS to ProDOS & vice versa.
- And many more.

BACKUP YOUR PROTECTED SOFTWARE.

With COPY II PLUS' fully automatic bit copier, simply type in the name of the program you want to backup and COPY II PLUS does the rest. (We update COPY II PLUS often to handle new protections; you as a registered owner may update at any time for \$15 plus \$3 s/h.)

Parameters for hundreds of programs are right on disk. Also includes a track editor, sector editor and HI-RES disk display. COPY II PLUS is supplied on a standard ProDOS diskette. Runs on Apple II, II+, IIe, IIc and Laser 128. Requires at least 64K and one or two disk drives.

Call 503/244-5782, M-F, 8-5:30 (West Coast time) with your   in hand. Or send a check for \$39.95 U.S. plus \$3 s/h, \$8 overseas.

\$39.95

Central Point Software, Inc.
9700 S.W. Capitol Hwy., #100
Portland, OR 97219

Central Point
Software
INCORPORATED

CIRCLE 184 ON READER SERVICE CARD

Backup utilities also available for the IBM, Macintosh, Commodore 64/128 and Atari ST.

the Apple II screen keeps the result from being as nice as a Mac image.

I built a simple ten-screen lesson about the solar system with this product. I created and tested the entire lesson in less than 30 minutes (mostly because I didn't worry about the quality of my artwork). I could never have created software this quickly with a traditional programming language.

Filevision Comparison

I couldn't help but think of Filevision while working with Tutor-Tech. The solar-system lesson was one I had also created with Filevision last year, using a feature that lets you link multiple Filevision screens together. The major difference between the two programs (other than their hardware) is that Filevision does not allow automatic scoring and that Tutor-Tech lacks highlighting and database features.

Editing is much easier with Macintosh-based products such as MacDraw and Filevision than it is with the Tutor-Tech program. I wish this program had an optional alignment grid, for example.

You can't relocate a Tutor-Tech graphic once you've drawn it on the screen. On the other hand, a sequential Undo feature lets you take a picture apart, piece by piece, until the screen is blank. If you place an object in the wrong location, you can erase it and add a new one without disturbing any other parts of the screen—not a bad trade-off.

Tutor-Tech's main contribution is that it allows teachers to concentrate purely on the lesson itself, without having to worry about the mechanics of programming, which is what the creation of computer-assisted lessons should be about! **+**

David Thornburg is the creator of Calliope, a nonlinear idea processor for the Apple II, IIc, and Macintosh computers. He enjoys hearing from readers and can be reached in care of this magazine.

APPLE SOFTWARE AT LOW PRICES

Samples from our library of public domain software for Apple II Family

Tutorials

- 000 BASIC tutorial \$5

Art

- 007 Tom's Tool kit, print fonts \$5
 023 Make drawings, paint w/ colors \$5

Word Processing

- 037 FreeWriter (Apple II+ needs paddle) \$5

Business

- 038 Home budget, calendar, calculator ... \$5
 039 General ledger, financial programs ... \$5
 040 Address book, amortization \$5
 042 Figure loan payments, stock analysis \$5
 044 Banking, finance, inventory control .. \$5
 045 House sale calculations, payroll \$5
 046 Taxes, net value, payment schedules \$5
 047 File Cabinet—database program, A/R .. \$5
 051 BasiCalc spreadsheet & utilities \$5
 056 Bank'n System-check balancer w/doc \$5

Education

- 062 Alphabet, spelling, word games \$5
 064 Drills: typing, spelling, states, math .. \$5
 065 Talking calculator, math drill, flash card \$5
 066 Teaching aids: grader, averager, tester \$5
 068 Story problems, metric conversion, history quiz \$5
 069 Geography game, fraction to decimal . \$5
 085 Elementary math drills: +, -, x, ÷ ... \$5

Food and Nutrition

- 092 Count calories, nutrient values \$5

Games

- 099 Chess, Breakout, Horse Race, etc. ... \$5
 110 Air Simulator, Acey Deucey, etc. \$5

Music

- 185 Build organ, compose, sounds \$5

Passion

- 190/191 Graphic displays, games \$10

Utilities

- 213 Best of utilities \$5
 226 Diversi-DOS—Faster than DOS 3.3 ... \$5

Communication

- 260/ Bulletin board system
261 with documentation (2 disk set) \$10
 262/ Hayes modem program &
263 utilities (2 disk set) \$10
 293 CP/M-XModem, APXModem, etc. ... \$5
 The Best of Apple Public Domain Software
150-page paperback directory \$6.95
 Complete set of 210 Apple disks (prepaid) \$695

SPECIAL!

**Any 6 disks plus
Apple directory
Only \$33⁹⁵**

The Best of
APPLE
PUBLIC DOMAIN
SOFTWARE



Add \$4 shipping for disk orders, or \$2 if ordering directory only. California orders add sales tax.

Enclosed \$_____ by check VISA MC

Card no. _____ Exp. _____

Signature _____

Name _____

Address _____

City _____ State _____ Zip _____

The Public Domain Exchange
2076C Walsh, Santa Clara, CA 95050 408-496-0624

CIRCLE 256 ON READER SERVICE CARD

PRODUCT INFORMATION

Tutor-Tech

Techware, Inc.
P.O. Box 1085
Altamonte Springs, FL 32715
Written inquiries only

List Price: teacher's disk, \$195;
student disk, \$5; grader disk, \$195

Requires: Apple IIe or IIc

CIRCLE 351 ON READER SERVICE CARD

COMPUTER CALISTHENICS

M A R C H 'S

WINNER

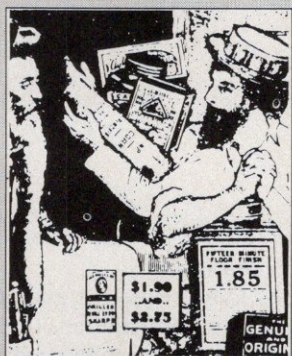

Jeffrey Zarkin

About a fourth of the entrants claimed there was no solution to the March puzzle. To them I say add and then multiply these numbers: 1.20, 1.25, 1.50, 3.16. Where these folks went wrong was in using real numbers instead of integers. (By the way, phoning the *A+* office to press your claims won't do you much good, since I'm hardly ever there.)

Another fourth came up with solutions such as 2.41, 1.15, 2.54, and 1.01, which produces 7.1100061. Close, but surely the clerk would have noticed when his desk calculator came up with a total with more than two decimal places.

Programs that solved the puzzle ran from as long as eight hours to just under one second, that from Jeffrey Zarkin of East Lyme, Connecticut, the March winner. He examined only multiples of the prime factors of 711,000,000 (79,5,5,5,5,5,3,3,2,2,2,2,2,2). He specified one number, Z, a multiple of 79 less than 9 (since $79 \times 9 = 711$) and not equal to 7 (that not being a prime factor) in lines 120-150. Five being a prime factor six times meant that one other number must be a multiple of 25, less than $711-Z$, and a multiple of the primes. In other words, 711,000,000 divided by $Z \times Y$ produces an integer (160-200). With Z and Y determined, two simultaneous equations must be solved: $X \times Y = 711000000 / Y \times Z$ and $X + Y = 711 - (Y + Z)$, which merge into one quadratic equation, $X \times X - S \times X + Q = 0$. After finding an acceptable solution, the program

returns to search all possible solutions, finding two (which are the same with a different order).

The cleverness of the programmer, rather than of the program, reduced a search of hundreds of billions of possibilities to 104, which is how it could

run so fast.

Phil Noble, of Weed, California, gets an honorable mention for the most improved program. His first program took more than 52 minutes. He followed with a second entry that ran in 27 seconds. **+**

```
1PRINT CHR$(27)CHR$(33)
```

```
1LIST
```

```
10 REM ADDITION=MULTIPLICATION
20 REM PROGRAMMED BY
30 REM JEFFREY A. ZARKIN
80 REM THIS PROGRAM FINDS FOUR VALUES W,X,Y AND Z SUCH
   THAT THEIR SUM IS 711 AND THEIR PRODUCT IS 711,000,000.
   ALL ARE POSITIVE INTEGERS
90 REM
100 REM INITIALIZE CONSTANTS
110 N = 0
120 REM DETERMINE VALUES FOR ZZ,Z
130 FOR ZZ = 8 TO 1 STEP - 1
140 IF ZZ = 7 THEN ZZ = 6
150 Z = 79 * ZZ
160 REM DETERMINE VALUES FOR YY,Y
170 YY = 25 * INT ((711 - Z) / 25)
180 FOR Y = YY TO 25 STEP - 25
190 REM DETERMINE W*X. DISCARD NONINTEGER RESULTS
200 Q = 711000000 / (Y * Z): IF Q - INT (Q) > 0 GOTO 310
210 REM DETERMINE X+W
220 S = 711 - (Z + Y)
230 REM SOLVE QUADRATIC EQUATION
240 REM EVALUATE DISCRIMINATE
250 D = S * S - 4 * Q: IF D < 0 GOTO 310
260 REM EVALUATE SMALLER ROOT, DISCARD IF NEGATIVE
   OR NONINTEGER
270 W = (S - SQR (D)) / 2: IF W < = 0 GOTO 310
280 IF W - INT (W) > 0 GOTO 310
290 REM EVALUATE LARGER ROOT, DISCARD IF NONINTEGER
300 X = (S + SQR (D)) / 2: IF X - INT (X) = 0 THEN 400
310 NEXT Y
320 NEXT ZZ
330 PRINT "NO ADDITIONAL SOLUTIONS EXIST-PROGRAM TERMINATED"
340 END
400 N = N + 1: PRINT "SOLUTION",N
410 PRINT "THE FOUR PRICES-IN CENTS-ARE:"
420 PRINT W,X
430 PRINT Y,Z
440 PRINT : PRINT
450 GOTO 310
```

```
JRUN
SOLUTION                1
THE FOUR PRICES-IN CENTS-ARE:
120                      125
150                      316
```

```
SOLUTION                2
THE FOUR PRICES-IN CENTS-ARE:
120                      150
125                      316
```

```
NO ADDITIONAL SOLUTIONS EXIST-PROGRAM TERMINATED
```

```
J
```





IT'S WHAT TDK MAKES FOR COMPUTERS THAT MAKES THEIR DISKS THE BEST.

The initial step from computer technology to computer disks was a natural for TDK, because they're more than manufacturers, they're creative innovators. TDK has used its expertise as one of the world's major producers of electronic component parts (including the most sophisticated heads for disk drives) to design floppy disks that deliver error free performance.

Absolute quality has always been a major source of pride for TDK. Their position as the world's largest manufacturer of magnetic media has been earned by an unparalleled level of technical superiority that spans over 50 years.

Millions of people around the world rely on TDK for the ultimate in audio and video recording performance. Now they can rely on TDK for the same consistently high performance in floppy disks. After all, PCs have feelings too. They deserve the TDK advantage other sophisticated electronic equipment has always enjoyed.

Let your PC know you care, choose from TDK's family of 5.25-inch standard, 5.25-inch High Density and 3.5-inch No-Risk™ Disks. Because it just doesn't pay to cut corners when it comes to floppy disks.

 **TDK**[®]
THE NO-RISK™ DISK.

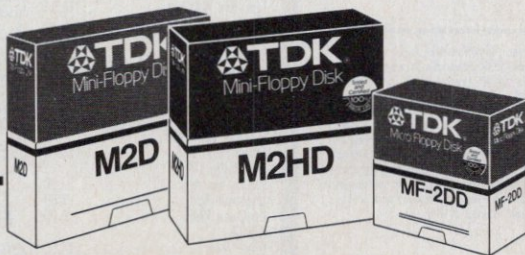

Northeastern Region: 516-625-0100; Southern Region: 404-948-1346; Midwestern Region: 312-676-5356; Western Region: 714-863-1844

© 1986 TDK Electronics Corp.

CALL TOLL FREE 1-800-382-2242

NORTHEAST SOFTWARE

7 Trap Falls Rd. Shelton, Connecticut 06484

(See Below)

WE WILL BEAT

- Tap our unmatched selection and inventory of software/hardware for the Mac and Apple (as well as the IBM PC and Commodore Amiga).
- School and corporate purchase orders are welcomed. CALL 1-800-874-1108.
- Special/rush orders. If something you need is not listed, hard to find, or needed in a hurry, CALL 1-800-874-1108.
- Order Status. CALL (203) 375-3860.
- Ask for System Sales when ordering a complete system.
- FREQUENT PURCHASER PROGRAM. Any repeat customer will automatically receive \$1 off any order he or she places with us. Please mention to your operator that you are a repeat customer. We value your continuing business. Send in \$1,000 worth of invoices (representing previous purchases) and you will receive a coupon worth 1% off any future purchase. With \$5,000 worth of invoices, receive a coupon worth 5% off any future purchase.
- No additional charges for credit card orders.
- Convenient hours. 7 days/week: 9AM-11 PM EST.
- FREE AIR EXPRESS SHIPPING. Purchase \$150 or more of software and for no additional charge we will ship your products by air courier. Mention this to your operator as you place your order.
- FURTHER DISCOUNTS BY MAIL. Circle the items in our ad you want, send the aid in with the coupon below and receive \$.50 off each item! Cut out a competitor's ad with a lower price and we will give you \$1 off his price (subject to the conditions below).

SPECIALS

Copy II Mac	17.50
Crickit Graph	136.00
Excel	221.00
Fontastic	29.00
Gato	24.00
Haba 800K Drive	240.00
Harrier Strike Mission	24.00
Imagewriter Ribbons	4.25
Mac Golf	34.00
Mac Lightning	57.50
Microsoft Word	108.00
Microsoft Typographer	108.00
Quick and Dirty Vol. 2	24.00
Sidekick with Phone Link	50.00
Supercrunch	187.00
Thinktank 512K	95.00
Turbocharger	52.00
Wizardry I	33.00

DESK ACCESSORY PROGRAMS

AFFINITY MICROSYSTEMS	
Tempo	56.00
BATTERIES INCLUDED	
Battery Pack	26.50
BORLAND	
Sidekick	40.50
Sidekick with Plobe Link	50.00
DREAMS OF THE PHOENIX	
Day Keeper Calendar	24.00
Twelve-C Financial Desktop	24.00
DUBL-CLICK SOFTWARE	
Calculator Const. Set	58.50
ELECTRONIC ARTS	
Custom Calc Set	33.50
ENTERSET	
Quick Set	61.00
Quick Point	25.00
MAINSTAY	
Type Now	26.75
HARVARD ASSOCIATES	
Desk Toppers	28.50
SILICON BEACH SOFTWARE	
Accessory Pack 1	20.00
VIDEX	
Mac Calendar	48.50

GRAPHICS SOFTWARE

ALTSYS	
Fontographer	232.00
Fontastic	29.00
ANN ARBOR SOFTWARE	
Advanced Animation Toolkit I	40.50
Animation Toolkit II	85.00
Animation Toolkit I	29.00
In Motion	82.00
Full Paint	67.50
APPLE COMPUTER	
Mac Draw	CALL
AXLON	
Card Shoppe	35.00
Art Portfolio	35.00
Art Portfolio II	48.00
BRODERBUND	
Printshop	CALL
CASSADY COMPANY	
Fluent Fonts	28.00
Fluent Laser Fonts	CALL
CENTURY SOFTWARE	
Laser Font Potomac	18.50
Laser Font Willamette	18.50
Ultrafonts	18.50
Ultrafonts/Technical & Business	30.50
Technical & Business Fonts	18.50
DIABLO VALLEY DESIGN	
Mac Grid	24.50
CHALLENGER SOFTWARE	
Mac 3D	112.50
CRICKET SOFTWARE	
Crickit Graph	136.00
DIVERSION INC	
Jumbo Color Pens	13.00
Underware Pens	9.00
Underware Ribbon	9.00
DRUID	
Classic Fonts	24.50
Graphic Letters	24.50

ENABLING TECHNOLOGIES

Easy 3D	57.00
ENTERSET	
Quick Point	25.00
HAYDEN SOFTWARE	
Davinci Commercial Interiors	112.00
Davinci Interiors	26.50
Davinci Houses	26.50
Video Works	54.00
Davinci Building Blocks	44.00
Davinci Landscapes	26.50
Home Design	44.00
Art Grabber W/Body Shop	27.40
INNOVATIVE DATA DESIGN	
Mac Draft	135.00
Paste Ease	28.50
KENSINGTON	
Professional Type Fonts-Headlin	39.00
Softforms	28.00
Professional Type Fonts-Text	28.00
MAGNUM SOFTWARE	
Slide Show Magician	31.00
MacPic Volume 1	26.00
MacPic Volume 2	26.00
MANHATTAN GRAPHICS	
Ready Set Go	55.00
MESA GRAPHICS	
Plot II	66.00
MICRO MAPS	
Mac Atlas World	49.00
Mac Atlas USA	49.00
MICROSPOT	
Mac Plot	125.00
MILES COMPUTING	
Mac The Knife Volume I	19.00
Mac The Knife Volume II	24.00
Mac The Knife Volume III	24.00
SUMMAGRAPHICS	
Mac Tablet 9x6	240.00
Mac Tablet 12x12	328.00
SUNCOM INC	
Macfont 1	17.00
T MAKER	
Click Art Publications	27.00
Click Art Effects	27.00
Click Art Letters	27.00
Click Art Personal Graphics	27.00

ACCOUNTING SOFTWARE

ARRAYS/CONTINENTAL	
Home Accountant	70.00
CHANG LABS	
Rogs to Riches GL	94.00
Rogs to Riches AP	94.00
Rogs to Riches AR	94.00
Rogs to Riches Inventory	94.00
DIGITAL ETC.	
Mac Accountant	75.00
INTERMATRIX	
Chequebook	25.00
MONOGRAM	
Dollars & Sense	79.00
Forecast	37.50
PALANTIR	
Accounts Receivable-Palantir	68.00
Accounts Payable-Palantir	68.00
Inventory Control-Palantir	68.00
General Ledger-Palantir	68.00
PEACHTREE	
Accounts Payable-Peachtree	81.00
General Ledger-Peachtree	81.00
Accounts Receivable-Peachtree	81.00
SIERRA INFO SYSTEM	
Accountants Choice Each	CALL
Mac One Write	133.00
Mac One Write Payroll	133.00
SOFTSYNC	
Personal Accountant	49.00
STATE OF THE ART	
Electric Checkbook	38.00
SIMON & SCHUSTER	
J.K. Lassers Money Manager	45.00
UNITED SOFTWARE	
In House Accountant	109.00

BUSINESS SOFTWARE

ADVANCED LOGIC SYSTEMS	
Mighty Mac	31.00

AEGIS

Zapl Invoice	61.00
Housekeeper The	33.00
ALDUS	
Page Maker	CALL
ALLEGRO SOFTWARE	
Multiplan Templates-Busns Anal	28.50
Multiplan Templates-Pers Finan	28.50
Softstart	28.50
APPLE COMPUTER	
Mac Project	CALL
APPLIED LOGIC SYSTEMS	
Mac Math Pac	260.00
APROPOS	
Financial Planning	35.00
Investment Planning	35.00
Tax Planner	24.00
ARTSCI	
Softforms	24.00
Magic File	57.00
ASSIMILATION PROCESS	
Business Essentials	CALL
Mac Spell Right	CALL
Right Word The	CALL
BLYTH SOFTWARE	
Omais III	238.00
BOSTON SOFTWARE	
Mac Publisher	99.00
BRAINPOWER	
Stat View	95.00
CHANG LABS	
Three Pack	227.00
BRAINSTORM	
Overture	CALL
COMPUTER: APPLICATION INC.	
II In A Mac	51.50
CREIGHTON SOFTWARE	
Mac Office	27.50
Mac Spell +	49.00
Mac Home	27.50
CRICKET SOFTWARE	
Crickit Graph	133.00
CRYSTAL CANYON	
Mac Librarian	28.00
DATAFOOD	
Drawforms	28.00
Mac Forms	38.00
DATALOGICA	
dMac III	CALL
DATAPACK SOFTWARE	
Executive Office	205.00
My Office	75.00
DOW JONES SOFTWARE	
Spreadsheet Link	60.00
Straight Talk	55.00
Dow Jones Membership Kit	17.00
Market Manager +	108.00
DREAMS OF THE PHOENIX	
Quick and Dirty Utilities 1	24.00
Quick and Dirty Utilities 2	24.00
ELECTRONIC ARTS	
Financial Cookbook	30.00
EMERGING TECHNOLOGIES	
Macoffix	78.00
ENTERSET	
Quick Word	30.00
FORETHOUGHT	
Factfinder	80.00
FilmMaker	98.00
FORTNUM SOFTWARE	
Mac Nest	30.50
HABA SYSTEMS	
Quartet	120.00
Haba Wills	29.00
Haba Business Letters	29.00
HARRIS TECHNICAL SYSTEMS	
Profit Projection/Breakeven Analysis	46.00
HAYDEN SOFTWARE	
I Know Its Here Somewhere	32.00
Ensemble	55.00
Hayden Speller	42.00
Hayden Chart	58.50
HAYES MICROCOMPUTING	
Please	122.00
HEYDEN & SON	
Stat Works	73.00
HOWARD SOFT	
Howard Tax Preparer	CALL
HUMAN EDGE SOFTWARE	
Mind Prober	26.00
LAZER SOFTWARE	
Lazerbase	58.50

LAYERED

Front Desk	72.00
LIGHTYEAR INC	
Lightyear	CALL
LIVING VIDEOTEK	
Think Tank 128K	49.00
Think Tank 572K	95.00
LOTUS DEVELOPMENT	
Jazz	365.00
MACNIFTY	
Studio Session	67.75
MAINSTAY	
Turbo Download	24.75
MAIN STREET SOFTWARE	
Main Street Writer	48.00
Main Street Filer	48.00
MEACOM	
Mac + II	68.50
MEGAHAUS	
Megafiler	90.00
MegaMerge	60.00
Megaform	145.00
MEGAMAX, INC.	
Megamax C Compiler	173.50
MESA GRAPHICS	
Tekalike	150.00
MICRO PLANNING SOFTWARE	
Micro Planner	237.00
Micro Planner Plus	295.00
MICROSOFT	
Excel	222.50
Chart	70.75
Multiplan	105.00
File	108.00
Typographer	108.00
Word	108.00
NEW CANNAN MICRO	
Mac Disk Catalog	25.00
Mac Disk Catalog II	30.00
NOLO LEGAL SOFTWARE	
Will Writer	23.00
ODESTA	
Helix	210.00
ODS INC.	
Consultant	108.50
Sales Consultant	CALL
PALADIN	
Crunch	77.00
Supercrunch	187.00
PALANTIR	
In Touch	73.00
PROVUE DEVELOPMENT	
Overture	140.00
PROTEKT-IT SOFTWARE	
Procopy / Proedit	26.00
REAL DATA	
Residential Real Estate	58.50
Financial Analyst	58.50
Tax Shelter Syndication Analyst	167.00
Real Estate Investment Analyst	87.00
Mortgage Qualifier	117.00
Property management I	173.00
On Schedule	117.00
Commercial Industrial Appl.	58.00
SATORI SOFTWARE	
Bulk Mailer	66.00
SIMON & SCHUSTER	
Construction Estimator	41.00
SMITH MICRO	
Market Link	49.00
Stock Portfolio System	135.00
SOFT DESIGN	
Timebase	79.00
SOFTSTYLE	
Decision Map	72.00
SOFTCH MICROSYSTEMS	
Mail Manager	38.00
SOFTVIEW	
Macintosh 85	43.00
SOFTWARE PUBLISHING	
PPS File Report Combo	93.00
PPS Report	69.00
PPS File	69.00
SOUTHEASTERN SOFTWARE	
Mac Transfer	28.00
STATSOFT	
Data File	38.50
STONEWARE	
DB Master Mac	102.00
SUPEREX	
Mac Notes	36.00

Send coupon and list of items desired to:
DISCOUNT BY MAIL DEPARTMENT
 Northeastern Software, 88 Ryders Lane, Stratford, CT 06497

To be eligible for the \$1.00 per item discount you must:
 1. Fill out all items. 2. Send in our ad with the items you desire circled.

Name _____
 Address _____ (Include Company Name)
 City _____ State _____ Zip _____
 Phone No. at above address _____
 Check form of payment
 Visa MasterCard C.O.D. Personal Check
 Certified Check Money Order
 Card No. _____ Exp. Date _____
 Computer Model _____

Personal and company checks allow 3 weeks to clear. For faster delivery, send cashier's check, certified check, or money order. Shipping—Software (\$3.00 minimum). Shipping—Hardware (please call 203-375-3860). COD—Add an addition \$2.00. Alaska, Hawaii, Canada, P.O. APO, and FPO \$5.00 minimum. Foreign orders—\$15.00 minimum and 15% of all orders over \$100. Mastercard and Visa (please include card no. and expiration date). Connecticut residents add 7.5% sales tax. Prices subject to change without notice. All returns must have a return authorization number. Call 203-375-3860 to obtain one before returning goods for replacement. Defective merchandise replaced with same item only. We do not guarantee compatibility. All sales are final. "Comparable advertised price" does not include typographical errors on the part of other vendors or prices that do not reflect higher shipping costs, credit card charges, or membership fees. The \$1 off offer only applies to items where Northeastern's price is not already the lowest. Final judgment remains with the manager on duty.

ASTER

ANY COMPARABLE ADVERTISED PRICE BY \$1

TELOS		HIPPOTAMUS SOFTWARE		HENDERSON ASSOCIATES		Fahrenheit 451	25.00	Mouse Cleaning Kit W/Pocket	14.90	Smartmodem 300	128.00
Filevision	91.00	Hippo Computer Almanac	17.50	Real Poker	18.00	Rendezvous with Rama	25.00	Mouse Pocket	6.00	Transet	255.00
Business Filevision	189.00	MARK OF THE UNICORN		HIPPOTAMUS SOFTWARE		UNICORN SOFTWARE		KETTE GROUP		Transet 1000 512K	265.00
WARNER		Professional Composer	234.00	Hippo Jokes & Quotes	17.00	Futura	23.00	Macnifty ABCD Port Switch	31.50	Transet/Mac Acc. Kit	27.00
Desk Organizer	53.00	MICROSOFT		INFOCOM		Utopia	23.00	Macnifty Stereo Music System	54.00	KENSINGTON	
LANGUAGES		Entrepreneur	28.50	A Mind Forever Voyaging	25.00	VIDEX		Macnifty A/B Switch	21.50	Portable Modem 300 Baud	85.00
APPLE COMPUTER		Learning Multiplication & Chart		Cuthroths	36.00	Mac Checkers & Reversi	27.00	KOALA TECHNOLOGIES		MICROMOD	
Mac Pascal	CALL	PALANTIR		Deadline	27.00	Mac Vegas	32.00	Mac Vision	167.00	Mac Modem 2400 W/Software	553.00
Macintosh 68000 Development	CALL	Mac Type	24.00	Enchanter	25.00	Funpak	21.00	Kat	131.00	Mac Modem 1200 W/Software	385.00
CONSULAIR		Word Play	25.00	Hitchhikers Guide to the Galaxy	22.00	Mac Gammon & Cribbage	26.00	KRAFT		NOVATION	
Mac C W/Tool Kit	265.00	Math Flash	25.00	Infidel	25.00			Quick Stick	44.00	Cat Comm Communication System	274.00
CREATIVE SOLUTIONS		QUEUE INTELLECTUAL SOFTWARE		Planetfall	22.00			MACADAM PUBLISHING		Novation 2400 Baud	CALL
Mac Forth Level I	70.00	Starting A New Business	43.00	Seastalker	22.00	AMERICAN TOURISTER		Windoware Phone Book	29.95	PRENTICE	
EXPERTELLIGENCE		RUBICON PUBLISHING		Sorcerer	25.00	Mac Carrying Case-Amer Tourist	53.00	Windoware Calendar	29.95	Popcop X 100	253.00
Expert Lisp	234.00	Song Painter	34.00	Spellbreaker	27.00	APPLE COMPUTER		MAGNUM SOFTWARE		PROMETHEUS	
Expert Ops 5	155.00	Deja Vu-Rubicon	21.75	Starcross	22.00	Mac Security Kit	CALL	Mouse Mover	12.00	Promodem 1200 W/Mac Software	318.00
Expert Logo	74.00	SCARBOROUGH		Suspended	25.00	ASSIMILATION PROCESS		MEGAHAUS		US ROBOTICS	
HIPPOTAMUS		Mastertype	28.00	Run for the Money	12.00	Mac Numeric Turbo	CALL	Megadesk	58.75	Courier 2400	380.00
Hippo-C Upgrade Kit	133.00	Run for the Money	12.00	Make Millions	28.00	Mac Port Adaptor	CALL	Password 1200	195.00	Password 1200	195.00
Hippo C Level I	71.00	Witness	28.00	SIMON & SCHUSTER		Mac Daisy Wheel Connection	25.00	MICROSTATION II	69.00		
Hippo C Level II	189.00	Zork I	23.00	Simon Art Department	23.00	Mac Epson Connection	CALL	MJ ELECTRIC	152.00		
KRITYA SYSTEMS INC		Zork II	23.00	Simon Typing Tutor III	30.50	AST RESEARCH		Mac Guard	CALL		
Neon	122.00	Zork III	23.00	Paper Airplane Construction Set	22.50	Ramstack 1.5 MB	995.00	MPH COMPUTERS	96.00		
MAINSTAY		KASTEL TECHNOLOGY		SPECTRUM HOLDBYTE		Ramstack 512K	550.00	NEW IMAGE TECHNOLOGIES			
Macosm	85.00	Trivia Savant	25.00	MARK OF THE UNICORN	21.00	Ramstack 2 MB	1575.00	Magic Digitizer	275.00		
MANX		MAGNUM SOFTWARE		Mouse Stampede	21.00	Ramstack 1 MB	795.00	OPTIMUM			
Aztec 68K-C	345.00	Mac Wars	25.00	MILES COMPUTING		AUTOMATION FACILITIES		Mac Tote	59.00		
MICRO ANALYST		Mac Attack	25.00	Mac Wars	633.00	Micro Clean	CALL	PRACTICAL COMPUTER APPLICATIONS	47.00		
Mac Zap	29.00	Fusillade	25.00	Mac Attack	25.00	Floppyclean Refill	CALL	Mac Backup	CALL		
MICROMOTION		Overlords	25.00	Mac Edge II	88.00	Floppyclean 3 1/2"	CALL	SOUTH BAY SYSTEMS			
Masterforth	88.00	Harrier Strike Mission	30.00	Mind Over Mac	84.00	CRT Work Station Kit	CALL	Mouse Pad	9.00		
MICROSOFT		MINDSCAPE		Mac Edge +	168.00	Proprint W/Cable	51.00	SUPEREX			
Basic-Microsoft	84.00	James Bond A View To A Kill	22.00	TIMEWORKS		Proprint	37.00	Mac Speak	14.00		
Fortran Compiler-Microsoft	168.00	Rambo	22.00	Evelyn Wood Dynamic Reader	73.00	Proprint W/AB Switch & 2 Cable	134.00	Click On Worksheet	45.50		
Logo-Microsoft	73.00	Balance of Power	28.00	ENTERTAINMENT		CURTIS MANUFACTURING		THUNDERWARE			
SOFTWARES LIMITED		Brattocuss	28.00	ACTIVISION		Ruby Surge Suppressor	43.00	ThunderScan	166.00		
Softworks C Compiler	234.00	Ractor	28.00	Alter Ego	34.00	Emerald Surge Suppressor	30.00	VIDEO 7			
BOOKS		Deja Vu-Mindscope	24.50	Mindshadow	23.00	Sapphire Surge Suppressor	43.00	Mouse Stick	35.50		
MICROSOFT PRESS		Sheahen King's The Mist	22.00	Borrowed Time	25.00	Diamond Surge Suppressor	24.00				
Mac Work Mac Play	12.50	MIRAGE CONCEPTS		Championship Star Baseball	12.50	Underware Color Ribbon	8.50	DIVERSIONS INC.			
Macinations-Microsoft	12.50	Trivia	11.50	AEGIS	21.00	Underware Jumbo Pens	13.00	6100S	375.00		
Apple Macintosh Book	12.50	New Gammon	18.50	Pyramid of Peril	21.00	Underware Colorpans	8.50	5510S	449.00		
Inside Macpoint	12.50	ORIGIN SYSTEMS		Mac Challenger	209.00	Underware Colorpack	15.00	6300S	639.00		
Presentation Graphics	12.50	Ultima III	36.00	Red Flag	21.00	Underware Black Ribbons	8.50	NEC			
Lotus Guide to Jazz	12.50	FBI SOFTWARE		ANN ARBOR SOFTWARE		ENVIRONMENTAL SOFTWARE		NEC 3510	990.00		
Printed Word The	12.50	Falkner Triplane	34.00	Grid Wars	22.00	Mac Cover Complete-Environment	12.00	NEC 3810	1270.00		
Macintosh Software Book of	12.50	Strategic Conquest	28.50	Unur Explorer	12.50	Dust Cover Laserwriter-Mac Attire	12.50	EIF 360	1376.00		
Inside Macproject	12.50	Feathers & Space	20.75	ARTSCI	12.50	Dust Cover Printer 15-Mac Attire	9.50	OKIDATA			
Macwork Multiphan	12.50	PENGUIN		ARTSCI	12.50	Dust Cover Disk Drive-Mac Attire	5.00	1935 Mac/Liso	CALL		
EDUCATIONAL SOFTWARE		Grimson Crown	22.50	ARTSCI	12.50	Dust Cover Printer 10-Mac Attire	9.00	1925 Mac/Liso	CALL		
ADDISON WESLEY		Graphics Magician	44.50	ARTSCI	12.50	ERGOTRON		TOSHIBA			
Smart Eyes	34.00	Pensate	22.50	AXLON	17.50	Mac Tilt	62.00	351	1020.00		
ATI		Transylvania	28.00	Mac Match	29.00	GTCC CORPORATION		1340	390.00		
How To Use Multiphan	38.00	Quest	28.00	BLUE CHIP SOFTWARE		Macintizer	435.00	351 Tractor	150.00		
Mac Coach	38.00	PRACTICAL COMPUTER APPLICATIONS		Squire	28.00	HABA SYSTEMS					
Teach Yourself Excel	38.00	Mac Golf	33.00	Baron	28.00	Haba Window Dailer	19.00				
Teach Yourself Jazz	38.00	PROFESSIONAL SOFTWARE		Tycoon	28.00	HANZON CORPORATION					
BRAINPOWER		Trivia Fever Volume II	12.00	Millionaire	34.00	Horizon Board & Cable	75.00				
Powermath	50.00	Super Sports Trivia	15.00	BRAINPOWER		INNOVATIVE CONCEPTS					
Chipwits	25.00	Trivia Fever	20.00	Torpedo Run	38.00	Flip N File I/Micro	15.00				
Thinkfast	20.00	PSION		Broderbund	38.00	Flip N File I/Micro	7.00				
CAMDE		Pison Chess	30.50	Cyborg	22.50	INNOVATIVE TECHNOLOGIES					
Nutricalk	47.00	PRIORITY SOFTWARE		Ancient Art of War	25.50	Essel The Pocket	11.00				
DAVIDSON AND ASSOCIATES		Forbidden Quest	19.00	Lode Runner	22.50	I/O DESIGN					
Spell II	26.75	Gateway	24.00	CBS SOFTWARE		Mac Carrying Case-I/O	21.50				
Word Attack	26.75	SIERRA ON LINE		Murder by the Dazen	15.00	Imagewriter Carrying Case-I/O	36.50				
Math Blaster	25.00	Ultima II	33.50	CHALLENGER SOFTWARE		KALMAR DESIGNS					
Speed Reader II	35.00	Frogger	21.50	Legacy	26.00	Micracomet-Double	20.00				
FIRST BYTE		Championship Boxing	25.00	CREIGHTON DEVELOPMENT		Micracomet	18.00				
Smooth Talker	47.00	SILICON BEACH SOFTWARE		Mac Command	17.00	KENSINGTON					
Kidtalk	38.00	Enchanted Scepters	30.00	ELECTRONIC ARTS		Siwell/Tilt-Kensington	21.00				
Speller Bee	38.00	Airbone	18.00	Pinball Construction Set	25.00	Siwell-Kensington	19.50				
FOPRETHOUGHT		SIR TECH		Deluxe Music Construction Set	35.00	Disk Case-Kensington	18.50				
Typing Intrigue	28.00	Wizardry I	22.50	One on One	35.00	Starter Pack-Kensington	51.00				
FORTNOM SOFTWARE		SOFT LIFE		Skyfox	47.00	Dust Cover Disk Drive-Kensington	6.00				
Mac Chemistry	97.50	Mac Slots	25.00	EPYX	47.00	Control Center-Kensington	57.00				
GREATWARE SOFTWARE		SPECTRUM HOLDBYTE		Rogue	38.00	Printer Stand	15.75				
Concertware +	35.00	Gato	24.50	Temple of Apshai Trilogy	38.00	Polarizing Filter	30.50				
HARVARD ASSOCIATES		STRATEGIC SIMULATIONS		Winter Games	38.00	A/B Box-Kensington	25.00				
Mac Manager	28.00	Gemstone Warrior	19.50	SYNAPSE		Surge Suppressor-Kensington	31.50				
HAYDEN SOFTWARE		SYNAPSE		Brinstone	25.00	Disk Drive Cleaning Kit	18.00				
Mac Modem	28.00	Essex	26.00	Windwheel	22.50	Dust Cover-Kensington	8.00				
HYDEN SOFTWARE		TELARIM		Holy Grail	34.00	Dust Cover Printer 10-Kensington	8.00				
Music Works	44.00	Dragon World	25.00	Computer Novel Construction Set	28.00						
Turbo Turtle	34.00	Amazon	25.00								

If you compute after dark...

...switch to the magic of GENie™ and stay on-line longer, for less!



Introducing GENie, the General Electric Network for Information Exchange. It's part of General Electric Information Services—the largest commercial teleprocessing network.

Now the power of GENie stands ready to bring a little magic into the life of PC owners just like you. And for potentially much less than other on-line information services.

With GENie, you pay no hidden charges or monthly minimum fees. You pay only for the actual time you're on-line and the \$18.00 registration fee. Nothing more.

Compare & Save

	Services						Pricing			
	SIGs/User Groups	Electronic Mail	CB Simulator	Computing News	Games	2400 baud access	Registration fee	Monthly minimum	Non-prime time rates	
									300 baud	1200 baud
GENie*	X	X	X	X	X	X	\$18.00	none	\$5.00	\$5.00
CompuServe	X	X	X	X	X	X	\$39.95	none	\$6.25	\$12.75
The Source	X	X	no	X	X	X	\$49.95	\$10.00	\$8.40	\$10.80

*Rates and Services shown in effect 12/85. Non-prime time rate applies Mon-Fri, 6pm-8am local time, all day Sat., Sun., and nat'l. holidays. Subject to service availability. Additional surcharge applies for 2400 baud service.

Save up to 60%

Check out the chart above and compare it for yourself. You'll find GENie can deliver all of your favorite services for an incomparable price at incomparable savings!

Put the power of GENie at your command

- Discuss the latest in computer products and accessories or download public domain software with GENie's **RoundTable™ Special Interest Groups**.
- Meet new people, share ideas with friends—old and new—with **LiveWire™**, GENie's CB simulator that has everybody talking!
- Get your message across and back again with **GE Mail™**, GENie's electronic mail service.
- Organize a local, regional or national get-together in one of GENie's 40 "conference rooms" with GENie's **Business Band Real-Time Conferencing**.
- Go one-on-one with classic computer games, match your wits against others with multi-player games, or download for future play in GENie's **Game Room**.
- Stay in touch with what's new on the microcomputer scene, courtesy of GENie's news service, **News and Commentary**.

GENie can take you to new highs in speed and keep you there. Because our non-prime time rate for 300 OR 1200 baud is only \$5.00 an hour. And that means you save 20 to 60%. Or if you prefer, 2400 baud service is now available.

With services and prices like these—talk, read, learn, or play to your heart's content. Because now you can keep your eyes on the screen, not on the clock.

With your personal computer, modem, communications software, and telephone, you already have everything you need to make GENie come to life. So why not Sign-Up today. Let GENie bring a little magic into your life!

Sign Up From Your Keyboard Today 4 Easy Steps:

1. Have ready your VISA, MasterCard or checking account number to set up your personal GENie account.
2. Set your modem for half duplex (local echo)—300 or 1200 baud.
3. Dial **1-800-638-8369**. When connected, enter HHH
4. At the U# = prompt, enter **XJM11943,GENIE** then RETURN.

No Modem Yet? Need more information or assistance? We can help! Call **1-800-638-9636, ext. 21**.

Get on-line with GENie. And stay longer, for less.



General Electric Information Services Company, U.S.A.

CARRIERS AT WAR

ESSEX

STAR TREK: THE KOBAYASHI ALTERNATIVE

KING'S QUEST II

That's Entertainment

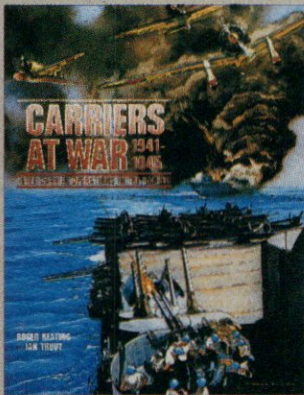

PACIFIC BATTLES REVISITED

Command the Japanese Task Forces attacking Pearl Harbor. Be an admiral at Midway or Coral Sea, or be a general commanding the 5th Air Force. These are only some of the possibilities with the solitaire-to-multiplayer Carriers at War, 1941-1945.

This war game simulates the air and naval battles fought in the Pacific during World War II. The game's scenarios allow players to recreate the historical battles of Pearl Harbor, Coral Sea, Midway, Eastern Solomons, Santa Cruz, and the Philippine Sea.

Carriers at War handles the complexity of the subject matter with a style

that makes playing the game enjoyable; easy; and, most important, fast-moving. The game is structured around a menu system, and you control all operations at the keyboard. The total of 30 menus may sound forbidding, but practice soon helps you overcome any confusion.

Carriers at War's Introductory Scenario introduces the game's system, using the Pearl Harbor scenario. In its presentation of this solitaire scenario, the manual guides you step by step, menu by menu through the first phase of the Japanese sneak attack on Pearl Harbor, familiarizing you with the various menu screens and their interaction.

Many games of this

type have players manually control the search phase, seeking the enemy fleet. Carriers at War, on the other hand, does this time-consuming chore automatically on every turn. Since the documentation does not point out this feature, players who are used to the manual search method may be confused. Aside from this minor point, however, players control all the other aspects such as task-force speed, heading, mission, CAP, and readying aircraft and aircraft strike missions.

An extraordinary feature of Carriers at War is its Game Design Option, a unique utility that allows players to create their own historical or hypothetical scenarios from 1900 to

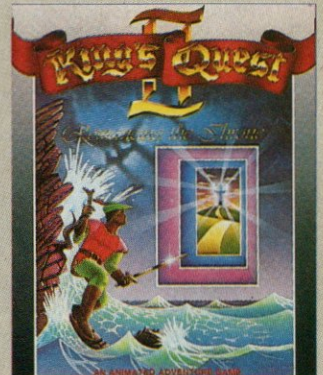
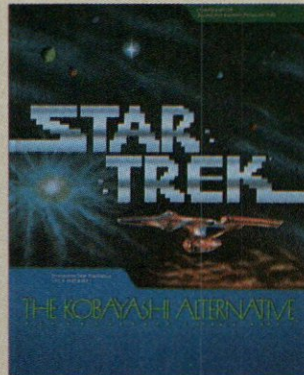

\$5 TALKING DISK

OVER 100 WORDS in vocabularies that you can put into your own programs! No extra hardware required. Sample programs include:

- Talking four-function calculator — choose English, Spanish, or German.
- Talking keyboard — letters and punctuation in English.
- Demonstration of voice editing.

The \$5 Talking Disk is available for Commodore 64, 128, Atari 800, 800XL, 130XE, and Apple II+ (64K), IIe, and IIc.

If you want to make your own vocabularies, in any language or accent, then you must have a VOICE MASTER for processing speech input. VOICE MASTER lets you do much more: YOU CAN RECOGNIZE SPOKEN COMMANDS and WRITE MUSIC AS YOU HUM! And affordable too — under \$90 including the headset and microphone.

Send \$5 for the talking disk. Prepaid orders only. Includes postage. (\$7 outside USA, Canada, and Mexico.) Information on VOICE MASTER will accompany your disk. Or you can call or write for VOICE MASTER information separately. Please specify computer make and model with your order.



COVOX INC.
675 Conger St., Dept. A
Eugene, OR 97402
Telephone (503) 342-1271

BUSINESS • SCIENCE • EDUCATION

The complete
Apple II
statistical
package
for only:

\$99

APP-STAT™

A Powerful Tool for Data Analysis and Forecasting

- Easy to use, no commands to memorize (menu-driven)
- Descriptive Statistics, t-tests (independent and dependent samples), General ANOVA/ANCOVA (up to five factors, **unlimited number of cases**, Repeated Measures, unbalanced designs, contrasts, adjusted means, and more), Correlations, Multiple Regression (up to 15 predictors, **unlimited number of cases**), Crosstabulation, Significance Tests, 10 Nonparametric Statistics, and more
- User defined (multiple) conditional selection of subsets of cases, various ways of treating missing data
- Flexible Data Editor; easy entering/editing of data, complex (conditional) transformations of variables, and more
- Can also access files created by spreadsheets and data bases
- Bar charts, Scatterplots, clear comprehensive output
- Will run on APPLE II+, IIc and IIe with 80 column display, 1 disk drive

To order send check or money order for \$99
(plus \$5 for shipping and handling) to:



StatSoft™



2832 East 10th Street, Suite 4, Tulsa, OK 74104. (918) 583-4149

ASK ABOUT THE VERSION FOR MACINTOSH!

CIRCLE 207 ON READER SERVICE CARD

That's Entertainment

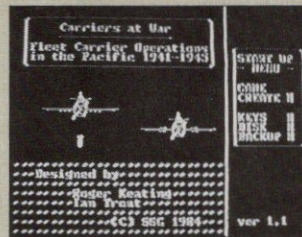

1955. Players can enter the hypothetical Raid on Ceylon scenario from the Game Design Manual to learn the ropes. The possibility of future scenario additions increases the variety and challenge of an excellent game system.

Carriers at War deserves commendation for its historical accuracy, enjoyment, playability, and expandability. It is destined to be a classic for novice and veteran strategists alike.

Richard L. Mataka

Carriers at War
Strategic Studies Group
Distributed by:

Electronic Arts
1820 Gateway Drive
San Mateo, CA 94404
(415) 571-7171

List Price: \$49.95

Requires: Apple II, II Plus, IIe, or IIc; 64K RAM
CIRCLE READER SERVICE NO. 358

ON THE TRAIL OF MALODOROUS MUTANTS

Like a recurring nightmare, the Vollchons, a race of alien monsters as ruthless, murderous, and ugly as aliens come, are attacking the peace-loving Federation again. Previously beaten in the Arcadus War, these malodorous mutants and their battle-machine destroyers have already conquered the Sirius sector.

Worse, Professor Ignatz Klein, the only scientist

with the knowledge to defeat the Vollchons, has crash-landed on a remote planet and is presumed dead. Furthermore, the only ship close enough to do anything is the Essex, an independent starship commanded by the misanthropic Captain Dee.

Essex, the second in a series of "Electronic Novels" published by Synapse/Bröderbund, is a text-only science-fiction

*You wander
within the
framework of
the story,
interacting with
other characters,
exploring strange
new worlds, and
solving puzzles.*

adventure game. It weaves a tale around a search-and-rescue-and-save-the-universe scenario. Unlike most text adventure games, which let you plug in the disk and start right away, Essex requires you to read several short chapters in a hardbound book. They set the scene, prepare you for the adventure, and provide clues.

As the hero, you wander within the framework of the story, interacting with other characters, exploring strange new worlds, and solving puzzles. The parser structure, which recognizes "over 1200 words," does a commendable job of translating your intentions into game action. Certain quirks, such as the inabil-

What every Apple II+ and IIe user should ask before buying the "Sider" 10 MB hard disk:

When a company offers a superior quality 10 megabyte Winchester hard disk for only \$695, it's bound to raise a few eyebrows... and a lot of questions. The fact is, you're probably already wondering "Can I really get a 10 megabyte hard disk that's *reliable* for only \$695?" The answer is: ABSOLUTELY...when you choose the Sider from First Class Peripherals.

What's so great about the Sider?

For starters, the Sider lets you boot your *Apple II+* or *IIe* directly off the hard disk—unlike some other Winchester subsystems. Rebooting is also trouble-free. And the disk is partitionable, allowing you to allocate space to four operating systems on the same disk. The Sider supports: Apple DOS 3.3; Pro DOS™; Apple Pascal; and CP/M®.

What's more, a small "footprint" lets you incorporate the compact Sider into your existing computer set-up with ease.

In addition, with the Sider, you not only pay far less for the subsystem, you also save money on installation. Because, unlike other 10 MB systems that require the purchase of expensive "extras," the Sider is *plug and play*. Everything you need is provided, including cables, host adaptor, installation software and manual.

What makes it so reliable?

To start, the Sider is manufactured, and sold exclusively, by First Class Peripherals, an innovative computer company which is backed by Xebec. The computer industry's leading manufacturer of disk controllers, Xebec has over a decade of experience serving customers like IBM, Toshiba, Texas Instruments and Hewlett Packard. It's this kind of expertise that helps assure the Sider's performance.

Special design features further enhance reliability. The Sider's controller is the field-proven, industry standard Xebec SL410A. And Xebec's 3200 drive tester, the

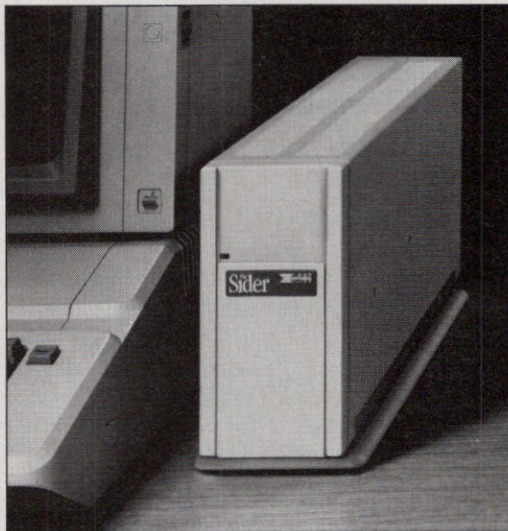

"Only \$695?"

toughest in the industry, ensures that the Sider will operate reliably. One more assurance of the \$695 Sider's quality: it's UL Approved and FCC Class B rated.

But why is it only \$695?

You pay less for the Sider than for other 10 MB hard disks simply because you're paying for the superior quality components inside the unit, not for a lot of retail overhead costs. Since First Class Peripherals sells direct, you avoid dealer and dis-

tribution expenses, and pay only for the product.

What about a guarantee?

Like many experienced Apple users, you may be reluctant to buy a hard disk priced at only \$695 without first seeing for yourself how it performs. That's why First Class Peripherals offers you a reassuring, money-back guarantee that eliminates any risk on your part. Simply order the Sider and use it for 15 days. Then, if you're not entirely satisfied, return it and receive a full refund—no questions asked.

The Sider also comes with a full one-year limited warranty. Plus, there's a convenient, toll-free hotline you can call anytime you have a technical or service question, or need help.

Don't delay. Order the Sider now.

To receive the Sider 10 megabyte Winchester hard disk subsystem for only \$695, simply order using the coupon below. For faster service, order by phone and charge to your VISA, MasterCard or American Express. (You can also call us if you have any questions or technical concerns about the Sider. We'll see you get the help you need.) Call toll-free:

1 800 538-1307
Extension 240

Yes, please send me the Sider, including half-height 10 megabyte Winchester hard disk drive, Apple adaptor board, cable, complete installation software and documentation.

I prefer to pay as follows:

- I've enclosed my check or money order for \$695* + \$15 shipping and handling, payable to First Class Peripherals.
- Please bill the following credit card account for \$695* + \$15 shipping and handling:
- VISA MasterCard American Express

Card # _____ Exp. Date _____

Signature _____
*Residents of CA, NV and PA, please add appropriate sales tax.

Name _____

Address _____

City _____

State _____ Zip _____

Telephone (area code) _____

Mail to:

**FIRST
PERIPHERALS
CLASS**

3579 Highway 50 East
Carson City, NV 89701
240

Apple and Pro DOS are trademarks of Apple Computer, Inc.
CP/M is a registered trademark of Digital Research, Inc.

That's Entertainment

ity to drag bodies around and the failure to follow a guy (perhaps Dee) who walks right by you, make me wonder, though. Another example, "push Fred out of the Turbolift," translates as *press Fred* (like a button on a console). Maybe I was press-



ing Fred's belly button by mistake.

Essex was delayed beyond its original release date. Evidently, the program had a few problems. Not all of them seem to be fixed. For instance, after uncovering the Vollchon spy (on the bridge no less), I knocked him out and then hit him again. The program informed me, "The spy lies here out of commission."

"I'm going to kill you," the spy says calmly. Before I could type a character, the poison-fanged spy bit me. Nothing like a surprise to shake up a cruise.

Nevertheless, the prose proves to be well written and fairly descriptive. The interplay between you and a tour group is entertaining and enlightening (at

least the first few times you play). You should pay attention to the ceaseless chatter. Some of the off-hand comments conceal clues. Another good idea is to question each member of the tour group about the other tour members.

Essex is a good adventure game but not a great one. Although portions of it stimulate your imagination, often you find yourself wandering aimlessly. The pace of your achievements, at least compared to their speed in Mindwheel and Brimstone (the first and third Electronic Novels from Synapse/Brøderbund), is slow. Die-hard science-fiction gamers might find Essex interesting. In fact, I would go so far as to liken it to a B-grade cult movie. Most

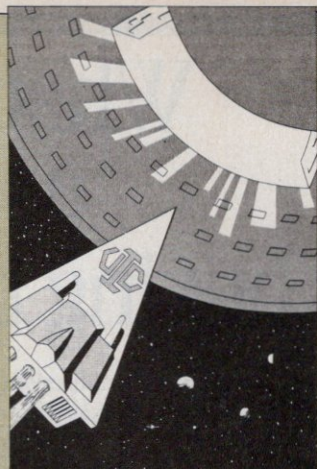

of you will probably want to pass it by, however, in favor of the excellent Mindwheel or Brimstone.

Russ Lockwood

Essex
Synapse/Brøderbund
17 Paul Drive
San Rafael, CA 94903
(415) 479-1120
List Price: \$44.95
Requires: Apple II, II Plus, IIe, or IIc; 48K RAM; one disk drive
CIRCLE READER SERVICE NO. 366

1 2 0 0 B A U D M O D E M S

Coit Valley Computers has two modems for your every need. Both are top quality state-of-the-art 1200/300/110 baud Hayes™ compatible modems; which means your computer can send & receive data at lightning fast speeds! And automatically switch between 1200 and 300 baud to communicate with slower Apples. Since neither comes with software, we carry Ascii Express ProDOS at a low price of \$89.

AVATEX™ 1200 EXTERNAL STAND-ALONE MODEM

\$199.

- 100% plug in Modem for **Apple IIc or Macintosh** with proper cable (see below)
- Universal modem that only requires modem compatible serial card (or port), & cable, to plug into **Apple IIe, Apple II+, or IBM**
- Auto Answer, Auto Dial, Auto Redial, Auto Disconnect
- Full Bell 212A compatibility
- Automatically switches between 300 baud & 1200 baud incoming speeds
- Complete diagnostics & full complement of LEDS (TR, SD, RD, HS, MC, TM, RI)
- DATA/VOICE Button switches from talk to data transmission & back again
- FREE Compuserve offer & free access time. One year warranty.

- Built-in Super Serial Card equivalent
- 1200/300/110 baud operation and Bell 212A compatibility
- Built-in Speaker & Diagnostics
- Auto Dial, Auto Answer, & Auto Select. Two year warranty.

2400 BAUD MODEMS — Call

CABLES REQUIRED WITH AVATEX MODEMS

Apple IIc - Avatex Cable	\$ 22.
Apple IIe, II+ - Avatex Cable	25.
Macintosh - Avatex Cable	27.
IBM - Avatex Cable	23.

OTHER APPLE PERIPHERALS

IIe/II+ Serial Modem Card	\$ 99.
RGB Monitor for Apple IIe	324.
RGB Monitor to Apple Cable	24.
MultiRam RGB cards (facing page)	→ →

CERMETEK APPLE-MATE™ 1200 INTERNAL MODEM

\$209.

- Internal 1200 baud modem for **Apple IIe or Apple II+**
- Only one card & takes only one slot w/ no external interface or power supply

With prices this low, how can you afford to be without a 1200 baud modem? Just the savings in connect time, will pay for the difference between a 300 & 1200 baud modem. You can get everything you need from Coit Valley Computers. Shipping on modems \$5-Ground/\$8-Air; monitors \$10. See terms on facing page.

Hayes, Avatex, Apple-Mate respective registered trademarks of Hayes Microcomputer Products, E+E DataComm, Cermetek Micro.

COIT VALLEY COMPUTERS • 14055 Waterfall Way, Dallas, TX 75240 • (214) 234-5047

That's Entertainment

SHOW YOUR CELESTIAL METTLE

In *Star Trek II: The Wrath of Khan*, we finally and definitely learned how Admiral Kirk wins all the time. He cheats.

That's how he passed the Kobayashi Maru test, a test of character to see how would-be Starfleet officers would respond to an almost certainly fatal situation. The test has now been replaced by The Kobayashi Alternative, a Star Trek simulation from Simon and Schuster. Just like the simulation it replaces, its purpose is to test the mettle of those who would presume to sit in the captain's chair of a Starfleet vessel. In this simulation, you play the part of Admiral Kirk.

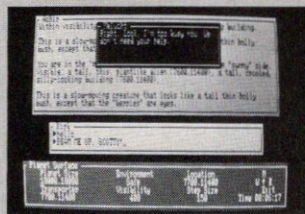

Your mission, Jim, is to find out what happened to the missing Federation ship *Heinlein* under the command of Acting Captain Lt. Sulu. The ship disappeared somewhere in the Trianguli region, and you have ten star systems to explore, each with its own host of planets, moons, and intelligent life forms, some of which may be hostile (others have never even seen a human being before). These are the races you have to interview to find out if they know what happened

to the *Heinlein*.

Be careful, Jim, the Prime Directive is in full force here.

Now, here's the hard part. When you do find the lost ship, your job is to find out what its *very mysterious and highly classified* secret mission was and assist in its completion.

Got that? Good.

Unfortunately, dear Candidate, you will not be given the same opportunities to cheat as Admiral Kirk has had. You have to play this one as it is written. And it is written very well indeed.

Read the programmers' credits. In addition to a highly talented team of Federation Class Software Engineers, science-fiction writer Diane Duane—author of two Star Trek nov-

els herself—helped design the essential story line. It makes for a high level of accuracy, playability, and imagination.

The Kobayashi Alternative is an all-text adventure, with a powerful difference. The game is played in multiple windows, which update automatically. You have ten function keys for giving, taking, examining, etc. What you type is what your character actually says. Major Star Trek characters—McCoy, Spock, Scotty, Uhura—have their own personality databases to recreate their distinctive characters in the game.

The first thing you're going to have to do here is *read the manual*. You can't learn this game easily by just getting into it and

MacroWorks™ makes AppleWorks™ work the way it should have in the first place.



New Word Processing Power

MacroWorks streamlines AppleWorks word processing with a multitude of new features. For example, one quick keystroke now deletes the character or the word at the cursor.

Return to our local office:
HARVEY R. SMITH
6502 DISK DRIVE

TYPE ALMOST ANYTHING WITH JUST ONE KEYSTROKE.

Use one keystroke to jump to the start or end of a text line. Another keystroke will erase an entire line. Change your mind? Apple-U will instantly "Undo" your last delete command!

AppleWorks Macros

MacroWorks will convert any series of keystrokes into a new one-keystroke solid-Apple command (original open-Apple commands stay intact). Use our built-in macros, or define your own. For example, make Apple-N type your name and address. Or let Apple-X save or print *all* of your Desktop files, nonstop.

For the Word Processor, Data Base and Spreadsheet

Be creative! Set up macros to execute *any* often-repeated function. You can even skip unwanted questions like "How many copies?"

Flexible and Compatible

Use MacroWorks on a floppy disk, hard disk, Unidisk 3.5™ or RAM disk. It is compatible with the Checkmate™ and Applied Engineering (RamWorks™ or Z-Ram™) Desktop Expanders.

MacroWorks is NOT a time-consuming "pre-boot" disk. You boot AppleWorks like you always do, but now you've got new features.



3990 Old Town Avenue, San Diego, California 92110
AVAILABLE AT MOST SOFTWARE STORES or by mail:
Visa, MasterCard or COD orders, phone toll free
1-800-227-3800 ext. 1607

Multi-Column Printouts!

MacroWorks' Galley program prints your AppleWorks Word Processing files in side-by-side columns (two or three-wide) for faster and easier newsletter layouts.

Analyze Your Files

MacroWorks' File Analyzer program prints a sorted list of every word it finds, and reports the number of occurrences of each word and the average word-length. Great for making an index or for analyzing your writing style.

• COUNT WORD	• 1 WORK
• 10 A	• 1 WRITING
• 1 ADDRESS	• 9 YOU
• 1 ADDRESSES	• 1 YOU'VE
• 6 ALL	• 8 YOUR
• 1 ALMOST	• TOTAL WORDS: 402
• 1 ALWAYS	• CHARACTERS: 2013
	• CHARS/WORD: 5.0

Alphabetize Your Catalogs

MacroWorks' Alpha-Cat program prints a sorted two-column list of all the file names on a disk. Perfect for disk I.D. labels!

\$34⁹⁵ Friendly and Unprotected

MacroWorks works with all versions of AppleWorks on any Apple IIc or 128K IIe. And you can make disk backups without hassle.

(AppleWorks is a trademark of Apple Computer, Inc.)

DOUBLE SIDED MAC DRIVE

\$249⁹⁵

COLOR MONITOR

- * TOP RATED FOR APPLE
- * 13" COMPOSITE VIDEO
- * RESOLUTION: 280H x 300V
- * INTERNAL AUDIO AMP
- * ONE YEAR WARRANTY



SAKATA SC-100 \$169⁹⁵

Sakata 120 CPS DOT MATRIX PRINTER



MODEL SP-1200 \$169.95

- * FRICTION AND TRACTOR FEED
- * PROPORTIONAL SPACING
- * CENTRONICS PARALLEL INTERFACE
- * 8 CHARACTER SETS AND GRAPHICS

6 FOOT IBM PRINTER CABLE \$9.95
REPLACEMENT RIBBON CARTRIDGE \$11.95

300 BAUD MODEM

- INCLUDES ASCII PRO-EZ MENU DRIVEN SOFTWARE
- * FCC APPROVED
- * BELL SYSTEM 103 COMPATIBLE
- * AUTO-DIAL
- * DIRECT CONNECT
- * INCLUDES AC ADAPTOR

\$49.95

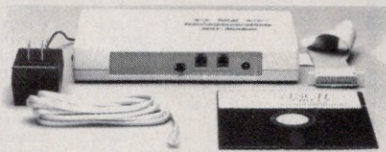

CABLE FOR APPLE IIc \$14.95
MODEM ADAPTOR CARD \$49.95
FOR APPLE II, II+ & IIe
USE WITH OUR 300B MODEM
FOR A COMPLETE SYSTEM—UNDER \$100!

DISK DRIVES

DOUBLE SIDED

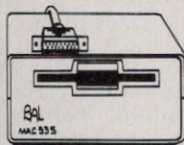

MAC 535 \$249.95

- * 3.5" ADD-ON DISK DRIVE
- * 100% MACINTOSH COMPATIBLE
- * DOUBLE SIDED, 800K BYTES STORAGE
- * HIGH RELIABILITY DRIVE HAS AUTO-EJECT
- * FULL 1 YEAR WARRANTY

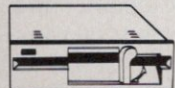

BAL-500 \$129.95

- * TEAC MECHANISM-DIRECT DRIVE
- * 100% APPLE COMPATIBLE
- * FULL 1 YEAR WARRANTY

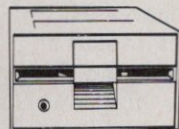

AP-135 \$129.95

- * FULL HT. SHUGART MECHANISM
- * DIRECT REPLACEMENT FOR APPLE DISK II
- * SIX MONTH WARRANTY

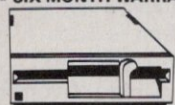

AP-150 \$99.95

- * 1/2 HEIGHT, DIRECT DRIVE
- * 100% APPLE COMPATIBLE
- * SIX MONTH WARRANTY

FOR APPLE IIc

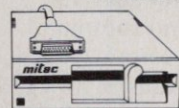

MITAC AD-3C \$139.95

- * 100% APPLE IIc COMPATIBLE, READY TO PLUG IN W/ SHIELDED CABLE & MOLDED 19 PIN CONNECTOR
- * FAST, RELIABLE SLIMLINE DIRECT DRIVE
- * SIX MONTH WARRANTY

DISK DRIVE ACCESSORIES

DISK CONTROLLER CARD \$49.95
APPLE IIc ADAPTOR CABLE \$19.95
ADAPTS STANDARD APPLE DRIVES
FOR USE WITH APPLE IIc

EPROM PROGRAMMER MODEL RP525 \$59.95

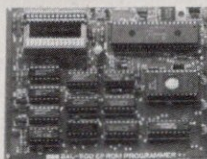

- * DUPLICATE OR BURN ANY STANDARD 27xx SERIES EPROM
- * EASY TO USE MENU-DRIVEN SOFTWARE INCLUDED
- * MENU SELECTION FOR 2716, 2732, 2732A, 2764 & 27128
- * HIGH SPEED WRITE ALGORITHM
- * LED INDICATORS FOR ACTIVITY
- * NO EXTERNAL POWER SUPPLY REQUIRED

IC TEST CARD

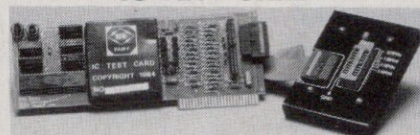

- * QUICKLY TESTS MANY COMMON ICs
 - * DISPLAYS PASS OR FAIL
 - * ONE YEAR WARRANTY
 - * TESTS: 4000 SERIES CMOS
74HC SERIES CMOS
7400; 74LS, 74L, 74S,
SOME PROMS AND RAMS
- \$99.95**

16K RAM CARD \$39.95 FOR APPLE II+

- * 2 YEAR WARRANTY
 - * EXPAND YOUR 48K APPLE TO 64K
 - * USE IN PLACE OF APPLE LANGUAGE CARD
- BARE PC CARD AND INSTRUCTIONS \$9.95

CASE WITH KEYBOARD FOR APPLE TYPE MOTHERBOARD

- * USER DEFINED FUNCTION KEYS
- * NUMERIC KEYPAD WITH CURSOR CONTROL
- * CAPS LOCK & AUTO REPEAT

MODEL KB-1000 \$799⁹⁵
KEYBOARD ONLY \$49.95

- * REPLACEMENT FOR APPLE II+
- * CAPS LOCK, AUTO REPEAT
- * ONE KEY ENTRY OF BASIC OR CP/M COMMANDS

MONITOR STAND \$12.95

TILTS AND SWIVELS TO PROVIDE OPTIMUM VIEWING ANGLE, REDUCES OPERATOR FATIGUE



DISKETTE STORAGE FILE

\$8.95

HOLDS 70
5 1/4" DISKETTES
WITH ROOM
TO SPARE

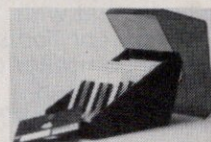

DS/DD NASHUA DISKETTES

\$9.90

BOX OF 10

69¢ ea

BULK QTY 50

JOYSTICK

CR401 \$7.95

WITH APPLE ADAPTOR CABLE



PS-A \$49.95

* +5V @ 5A, +12V @ 2.5A
* -5V @ .5A, -12V @ .5A



VISIT OUR RETAIL STORE LOCATED AT 1256 SOUTH BASCOM AVENUE IN SAN JOSE

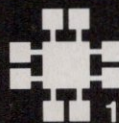

JDR Microdevices

1224 S. Bascom Avenue, San Jose, CA 95128

Toll Free 800-538-5000 • (408) 995-5430

FAX (408) 275-8415 • Telex 171-110

© COPYRIGHT 1986 JDR MICRODEVICES

THE JDR MICRODEVICES LOGO IS A REGISTERED TRADEMARK OF JDR MICRODEVICES. JDR MICRODEVICES IS A TRADEMARK OF JDR MICRODEVICES. APPLE IS A TRADEMARK OF APPLE COMPUTER.

HOURS: M-W-F, 9-5 TU-TH, 9-9 SAT, 10-3

PLEASE USE YOUR CUSTOMER NUMBER WHEN ORDERING

TERMS: Minimum order \$10.00. For shipping and handling include \$2.50 for UPS Ground and \$3.50 for UPS Air. Orders over 1 lb. and foreign orders may require additional shipping charges - please contact our sales department for the amount. CA. residents must include applicable sales tax. All merchandise is warranted for 90 days unless otherwise stated. Prices are subject to change without notice. We are not responsible for typographical errors. We reserve the right to limit quantities and to substitute manufacturer. All merchandise subject to prior sale.

PRO/PAC™

Professional Software Packages

14925 Memorial Drive, Suite 123, Houston, Texas 77079
(713) 496-1179 Dept. A

PCP-PRINTER CONTROL PROGRAM

PRINTER CONTROL PROGRAM will help you set up your dot matrix printer with just the "touch of a key". This menu-driven pre-boot program allows you easy access to your printer's various fonts.

Join the thousands of satisfied users of the "ORIGINAL" PRINTER CONTROL PROGRAM—a user-friendly utility that sends command codes to program your printer for such print choices as: Bold, Emphasized, Double-Wide, Italics, NLQ and many combinations. Of course, the exact options depend upon the printer model but ALL versions offer many features.

PCP allows you to preview your choice of printstyle and make any changes you desire. PCP is available for all Apple II and III computers with dot matrix printers such as Apple DMP, Imagewriter I/II, Epson, C.Itoh, NEC, Okidata, Star, Panasonic, Canon and many others. New printers are added frequently.

We believe that PCP will help you to use the many features of your printer quickly and easily. Be sure to specify your computer and printer for receipt of the correct version. Only \$29.95 plus \$2.00 for shipping. "Just the touch of a key" can set your printer up to print your way!

THIS IS THE SMALL PRINT:

Prices, availability and specifications are subject to change. Returns require prior authorization. Texas residents must add appropriate sales tax. VISA and MasterCard orders not charged until we ship. Cashier's Check or Money Order payment may deduct 2% from merchandise total. S/H charges: \$2.00 Minimum, Software \$2.00 each, AE products—\$5.00 each, Diskettes—\$2.00/10, UPS ground shipping in the continental USA. Add 5% to total for shipment to P.O. Boxes, APO, FPO or Foreign countries.

WE NOW OFFER SOFTWARE & HARDWARE!

PINPOINT	\$45
TIME IS MONEY	\$68
PRINT SHOP	\$36
GRAPHICS LIBRARY	\$19
NEWSROOM	\$36
CLIP ART COLLECTION	\$29
MIND PROBER	\$36
TYPING TUTOR III	\$36
WHERE? CARMEN SAN DIEGO	\$29
SENSIBLE SPELLER	\$75
SENSIBLE GRAMMAR	\$60
ALL PFS SERIES	FROM \$70

APPLIED ENGINEERING PERIPHERALS

RAMWORKS II 64K	\$142
RAMWORKS II 256K	\$175
RAMWORKS II 512K	\$215
Z-RAM 256K/512K	\$267/\$311
RGB	\$106
TIMEMASTER	\$106
Z-80+ & Z-80C	\$113/\$129
VIEWMASTER	\$112
//C SYSTEM CLOCK	\$ 63
TRANSWARP	\$223
DISK DRIVES	\$113
KENSINGTON SYSTEM SAVER -	\$67
DISKETTES - NAME BRAND & BULK	BONUS-\$8.95
PRINTER INTERFACE CARDS	
GRAPPLER PLUS -	\$78
IMAGEBUFFER -	\$72
RAM CHIPS/DUST COVERS/RIBBONS	

THESE ARE JUST EXAMPLES. ALWAYS AT DISCOUNT PRICES - AT LEAST 20% OFF RETAIL. CALL OR WRITE FOR CATALOG.

CIRCLE 172 ON READER SERVICE CARD

You probably already know that Computers Need Maintenance!

But did you know that with **Intelligent Tools** your computer can maintain and diagnose itself?

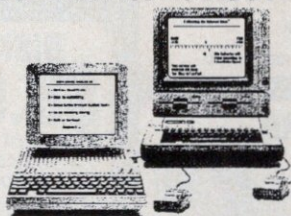

MASTER DIAGNOSTICS™

Master Diagnostics provides all of the tools and knowhow necessary so that *anyone* can do monthly maintenance duties. Calibrating disk drive speed, cleaning drive heads, checking track alignment or just adjusting your monitor to peak clarity is a snap.

In addition to the maintenance routines, extensive diagnostic procedures are available at the touch of a key. With our **new diagnostic construction set**, you can create peripheral diagnostics for any device card. Problems are diagnosed down to the chip level and tests will report: *what's right, what's wrong, what to do and how to do it.* Not just pass-fail exams like others!

The user manual is easy to understand and is packed with money saving U-DO-IT information. The Drive Analyzer tests and calibration routines alone will pay for Master Diagnostics after using it just once.

Expert Opinions

Nibble magazine says, "This program should be in the library of every Apple user". Howard Sams Tech Manual, Apple Orchard, Incider, Popular Computing, and the Apple II Review have all awarded Master Diagnostics with triple AAA ratings. *Consumers Guide* chose Master Diagnostics as one of the best programs for 1985.

WHEN ORDERING SPECIFY:

version: II+, IIe or IIc
Master Diagnostics - \$65.00
With Head Cleaning Kit - \$75.00
Drive Analyzer alone - \$39.95
(Included with MD)

Visa, MC, COD, School PO's
Call Free 1-800-835-2246

NIKROM

Technical Products, Inc.
176 Fort Pond Road ♦ Shirley, MA. 01464

CIRCLE 329 ON READER SERVICE CARD

That's Entertainment

hacking around. Fortunately, you get a card of the most common commands to put next to your keyboard. It all takes a little bit of getting used to, but it's worth the effort; once you get the hang of it, it's practically addictive.

The good news here is that you have all the facilities of the *Enterprise* at your disposal: transporters; communicators; tricorders; phasers; computers; and, of course, the ever-popular photon torpedoes. The turbolift can take you to any part of the ship, although you'll probably have to draw yourself a map.

The bad news is that there are a lot of ways to die in *The Kobayashi Alternative*. In the original "Star Trek" episodes, there was never any doubt who was going to live and who was going to die. For instance, if Kirk, Spock, McCoy, and Crewman Newman (who we've never seen in any other episode before) were all to beam down to the surface of a strange alien planet, it was no secret at all who was going to be eaten by the Great Ghastly Green Globber—and usually before the first commercial.

No, it was never Kirk, Spock, or McCoy who got an on-site inspection of the Ghastly Green Globber's alimentary canal. Or, if one of them somehow had the bad luck to die in the middle of the show, the others found a way to resurrect him before the final fadeout—or at least in the next movie.

Unfortunately for the Officer Candidates playing *The Kobayashi Alternative*, this simulation is not as forgiving. Here,



when Kirk makes a mistake, it's Kirk who dies.

Blessed be the programmers—there are all kinds of great ways to die, such as beaming into the center of a mountain. And in this simulation, death is for keeps. There are no convenient reincarnations, resurrections, or friendly alien supergods to put you back together and into the game so you can keep on going.

The disk won't self-destruct, though, so you do get an unlimited number of second chances—if you're willing to start at the beginning again. If nothing else, this game will teach you caution!

Two commands are most valuable to a new player. The first is Scan. You cannot possibly do too much scanning. Every piece of information is valuable—if not for winning the game, then certainly for your survival.

The second command you already know. It goes like this (in unison now): "Scotty! BEAM US UP!"

David Gerrold

STAR TREK: The Kobayashi Alternative
Simon & Schuster, Inc.
Simon & Schuster Building
1230 Avenue of the Americas

New York, NY 10020
(212) 245-6400

List Price: \$39.95

Requires: Apple II, II Plus, IIe, or IIc; 64K RAM
CIRCLE READER SERVICE NO. 367

Interlude II

MATA HARI—Interlude #156

What time does your flight arrive?

Oh, are you picking me up?

Look for a tall brunette in a trenchcoat... and nothing else.

Ah, you've been playing Interlude again!

Right.

Maybe I can catch an earlier flight.

Please do.

Interlude II. The long-awaited sequel to the first adult computer game in history is finally here. It's provocative and playful! Outrageous and romantic! It has all the excitement of the original Interlude, plus significant new features.

The computerized interview, which is taken by one or both players, has been greatly expanded. It probes your innermost desires to discern your mood of the moment, your secret longings, your special fantasies, and then suggests for your pleasure one of its more than 160 Interludes. You can ask the computer for an Interlude for now, or one for later. Special options give each player added control over surprises and special erotica hidden in the Interludes.

The original Interlude took the computer world by storm six years ago, creating a media sensation:

FORUM Magazine: "The Interludes are imaginatively and sensitively written... the computer's recommendations are uncannily appropriate."

US Magazine: "The most edifying third party to join couples between the sheets since The Joy of Sex."

Chicago Tribune: "This marriage of computer technology and sex is natural... erases forever the image of computer-users as dull guys with slide rules in their pockets and square roots on their minds."

Money Magazine: "Sometimes it's easier to tell a computer what you want than it is to tell your partner."

Interlude II will take you to the outer limits of fantasy and romance. And, if the computer selects Interlude #99 your love life may never again be the same.

Interlude II. Are you ready for it?

CIRCLE 177 ON READER SERVICE CARD

Send your check or charge information to:

INTERLUDE, 11011 Richmond, Suite 600, Houston, TX 77042

A+

NAME _____ AGE _____

ADDRESS _____

CITY _____ STATE _____ ZIP _____

CHARGE CUSTOMERS MUST SIGN HERE _____

____ MASTERCARD ____ VISA ____ AM EX ACCOUNT NO. _____ EXP DATE _____

CHARGE CUSTOMERS:

1-800-752-7001 ext. 829

(in Texas call 1-800-442-4799 ext. 829)

Available for Apple II, II+, IIc and IIe.¹

¹Trademarks of Apple Computer, Inc.

\$ 39.95 Interlude II

Shipping (\$3.00 or \$10.00 outside U.S.A.)

TX residents add 6½% sales tax—\$2.45

\$ _____ TOTAL

That's Entertainment

HERE YE, THERE YE

This time the castle rumors were as trustworthy as the world almanac! Just as I'd heard, there now really is a sequel to my best-selling, award-winning, first starring vehicle, King's Quest. In days of yore, a king's exploits were

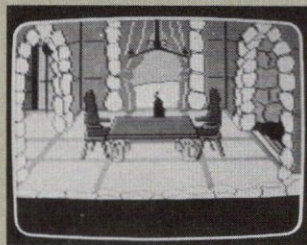

glorified in folk stories and ballad-songs, but since this is 1986, my doings have been recorded in animated graphic adventure games. I think that's a

heck of a lot more fun than all that "And then it came to pass" stuff. I wouldn't entrust the rights to tell my story to just anybody, though. Nosirree-bob. I picked Sierra On-Line, pioneers of the graphic-adventure-game format.

Oh, sorry, I'm so excited about this new game that I almost forgot to introduce myself. I'm King Graham. I used to be Sir Graham, and, as you may already know, the original King's Quest recounts how I got to be King of Daventry.

Well, let me tell you, it's hard work being King—and lonely, too. Even kings need companionship. So one day, I happened to glance into the magic mirror in my throne room, and what did I see staring back at me? A vi-

sion of such loveliness, such exquisite perfection of form and face that I fell helplessly, hopelessly, and



maddeningly in love. No, I didn't see *myself* in the mirror—it was the face of the fair maiden Valanice, from the kingdom of Kolyma. I knew instantly that I had to make her my Queen. But how? The wicked, jealous old crone Hagatha has imprisoned Valanice in a quartz tower in an enchanted land, guarded by a ferocious

King-eating beast!

I had heard of this enchanted land, but to get there I had to find three special golden keys. So I traveled far and wide throughout Kolyma looking for them, exploring the caves, castles, and underwater wonderlands of that faraway kingdom. I had to watch out for the evil Enchanter, stay clear of the

It's hard work being King—and lonely, too. Even kings need companionship.

pesky Dwarf, and avoid the clutches of the big, bad wolf. I even had to out-

Here's How to Screen Your Grammatical Errors

Sensible Grammar saves you embarrassment and improves your credibility by helping you screen out the grammatical errors in your papers. And it's easy to use on your Apple II computer because it is AppleMouse compatible and has Macintosh-like screens.

Possible mistakes are shown to you in context, a replacement word or phrase is suggested, and you are then given the option to accept or reject the suggested correction.

Sensible Grammar does much more than catch bad grammar. It also...

- checks your capitalization and punctuation, as well as the spelling of abbreviations;
- searches out phrases that are inconcise, vague, wordy, faulty or repetitive;
- points out expressions that are informal, pompous or sexist;
- calls attention to cliches, slang and trite language;
- allows entry of your personal hackneyed expressions and then lets you know every time you use them.

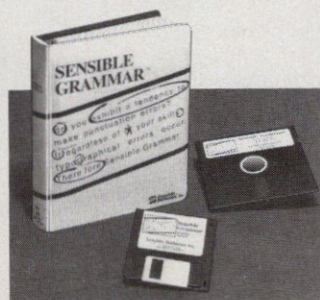
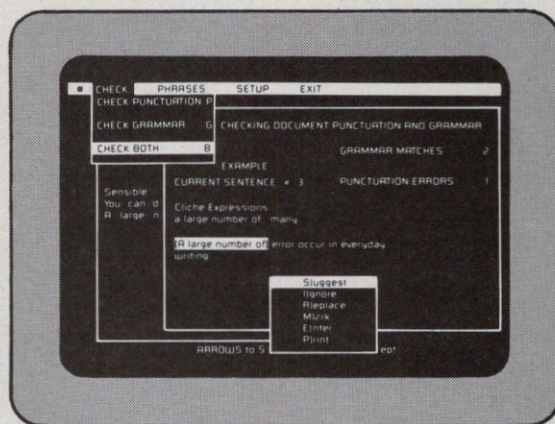

Sensible Grammar™

for your Apple //c and //e computer is available for \$99.95.

AppleWorks Compatible!

*Sensible Grammar works with the following word processors, AppleWorks, AppleWriter-ProDOS version (Apple Computer, Inc.); Format II Enhanced-ProDOS (Kensington Microware), Mouse Write text files (Roger Wagner Publishing); MouseWord (International Solutions); PFS:WRITE-ProDOS (Software Publishing, Inc.); Word Juggler (Quark Inc.); Zardax-ProDOS (Computer Solutions) and others. Owners of trademarks indicated in parentheses.



Sensible Software, Inc.

210 S. Woodward, Suite 229, Birmingham, MI 48011
(313) 258-5566

Which Apple works better?



With new Z-RAM II installed, the Apple on the right works a whole megabyte better!

A little while ago, the owner of the Apple on the right unscrewed its hood. And in a few quick minutes, he turned his IIC into a whole new machine. With the new 1 megabyte Z-RAM II, Applied Engineering's powerful new version of an already awesome expansion card.



*"I recommend
Applied Engineering
products wholeheartedly."*

*Steve Wozniak, the creator
of Apple Computer*

Now his Apple can completely load programs into RAM — and then store, load and run them up to *30 times faster*. And our included RAM disk is compatible with Applesoft, PRO-DOS, DOS 3.3, PASCAL and CP/M.

Turbo Charged AppleWorks.

Even a 256K Z-RAM II can completely load AppleWorks into RAM. With Z-RAM II, AppleWorks responds the moment your fingers touch the keyboard. A 256K Z-RAM II lets your IIC run AppleWorks up to 30 times faster, expands the clipboard, and increases available desktop memory to 229K.

Only Z-RAM II increases the maximum number of records from 1,350 to over 15,000. And only Z-RAM II increases the number of lines allowed in the word processor from 2,250 to over 15,000, provides a print spooler, and auto segments large files so they can be saved on two or more disks.

And for those who crave even more power, Z-RAM is available with 512K, 768K or 1 megabyte of main memory!

Welcome to the world of CP/M.

But perhaps the best news is that Z-RAM II has a built-in high speed Z-80B microprocessor that allows you to run CP/M programs. Which means you now have access to the single largest body of software in existence, including popular packages like WordStar, dBase II, Turbo PASCAL and Microsoft BASIC.

Z-RAM II is compatible with all IIC software and hardware, installs easily in just ten minutes with only a screwdriver, is available with memory upgrades up to 1 MEG that can be user-installed at any time. Z-RAM II is easily handled by the IIC power supply with our patent pending power saving design. In fact, a 1 megabyte Z-RAM II draws less power than a 512K Z-RAM.

For fast response.

Z-RAM II comes complete with simple instructions, RAM disk software, Z-80 operating system, CP/M manual, and a five-year "hassle free" warranty.

Make your Apple — and AppleWorks — work better. With 256K Z-RAM II (\$329); 512K (\$389); 768K (\$449); 1 MEG (\$599).

If you want to run CP/M software, but don't need more memory, we suggest our Z-80c card. The Z-80c has no memory expansion ports and is priced at only \$159.

Call 214-241-6060 TO ORDER TODAY. 9 a.m. to 11 p.m. seven days, or send check or money order to Applied Engineering. MasterCard, Visa and C.O.D. welcome. Texas residents add 5½% sales tax. Add \$10.00 outside U.S.

AE Applied Engineering
The Apple enhancement experts.

P. O. Box 798, Carrollton, TX 75006, (214) 241-6060

That's Entertainment



smart old Hagatha herself; lucky for me she's hard of hearing. Oh, and that other guy—you know the one I mean, that awful pain in the neck—I had to deal with him too. *Twice*. No problem for me, since I had the right stuff. When he first saw me, he went batty. Cross my heart, that's what happened. And then in our second encounter, I fixed his wagon so that he'll never bother anyone ever again. I'll stake my reputation on that.

Other than the one I just mentioned, the rest of my obstacles weren't that difficult—especially because I was aided by a luscious mermaid, a devout monk, and several loquacious members of the animal kingdom.

You'll definitely have a blast helping me relive my quest. The programmers at Sierra On-Line did a top-notch job of perfectly capturing the beauty of Kolyma's 90 or so locations. Many of the screens are animated: Flags wave in the breeze; flames flicker and burn; waves lap the shore; and, at your command, doors and treasure-filled chests open and close. And there're lots of nifty surprises on the three-disk, five-sided game that I won't spoil by

giving away in advance. I will casually add, however, that when you see what happens when I finally find Valance, I hope you don't blush easily!

You can control my likeness by using either the joystick or the key-

board, but you'll have to use the latter for all the text input. And just as in the original KQ, you can make me walk all the way

around trees and buildings, and I still do a mean breaststroke. And, to top things off, there are still those generous 26 save-game positions!

So please, everybody, you just have to go out and buy KQII. Since you need 128K to play it, now is the time to upgrade, if your machine isn't capable. And if KQII is as successful as it deserves to be, who knows where I might go from here?

King Graham (Donald Oliver)

The King's nemeses include a big, bad wolf, a pesky dwarf, and the evil Enchanter.

King's Quest II: Romancing the Throne
Sierra On-Line, Inc.
Coarsegold, CA 93614
(209) 683-6858

List Price: \$49.95

Requires: Apple IIe or IIc; 128K RAM; one disk drive

CIRCLE READER SERVICE NO. 369

YOU CAN DO A LOT MORE WITH MUSIC THAN YOU'RE DOING NOW!

- Did you play an instrument in school?
- No matter what your musical background is, these new computer music products will bring out your talents!

MIDI
HARDWARE
SOFTWARE

- SYNTHESIZERS AND DRUM MACHINES
- COMPUTER SOFTWARE AND HARDWARE
- SEQUENCES, PROGRAMMERS
- HOME RECORDING EQUIPMENT



FUTURE MUSIC

START YOUR COMPUTER MUSIC SYSTEM TODAY

\$299 CASIO CZ101 SAVE \$200

PROFESSIONAL SYNTHESIZER SOUND. UP TO 4 UNIQUE SOUNDS AT ONCE. MIDI. PROGRAMMABLE. PORTABLE. EASY TO USE — THE STANDARD —

FREE AC ADAPTER & SHIPPING

BOOKS ON MIDI, MIDI PRODUCTS

- Understanding Midi - 82 Pages 3.95 w/Product Guide
 - How to Understand & Program the DX7 ... 24.95
 - Synthesizer Technique 8.95
- Send cost plus \$1.50 postage and handling to the address below or call toll free to order.

FUTURE MUSIC IS THE ONLY MUSIC STORE DEVOTED TO COMPUTER ENTHUSIASTS & HOME MUSICIANS.

MASTERCARD AND VISA ACCEPTED

CALL 24 HRS. TOLL FREE!

1-800-FOR-MIDI

USE YOUR APPLE II+/IIe/IIc!! \$84.95 TEXTURES MIDI SEQUENCER

SAVE \$15 Write music in easy to change phrases, then loop, chain or edit them into songs.

\$99.95 MIDI 4+ SEQUENCER

SAVE \$30 Records MIDI data for playback. Perfect for the CZ101, with 4 different sounds at once!

\$99.95 APPLE IIe MIDI INTERFACE

SAVE \$30 Required to use MIDI software and MIDI synthesizers with Apple computers.

\$89.95 VOICE EDITOR/LIBRARIANS

SAVE \$10 Help programming your own sounds! Available to Yamaha DX or Casio CZ.

Apple IIc Interface Available & Many Educational Programs Too!

WE HAVE MANY MORE PRODUCTS AVAILABLE. IF YOU DON'T SEE WHAT YOU WANT HERE, CALL US!

NEW! AMIGA AND ATARI ST! CALL FOR LATEST MUSIC PRODUCT INFORMATION

MACINTOSH

	List	Sale
MIDI Conductor Interface	\$ 89	\$ 69
MOTU Prof. Composer	495	435
Performer	295	260
Opcodes Sequencer (V2.0)	200	175
DX or CZ Editor	125	105
Librarians	50	42
128/512 Interface	125	95
MAC Plus Interface	200	160
Digital Sampler Editors		CALL!

KEYBOARDS, SYNTHESIZERS, ETC.

DX7/TX7 Programs (1000s!)	\$1	Each
DX/RX 128 Voice		
Ram Carts	125	95
CZ Series 64 Voice Carts	45	37
4 Track Recorders		CALL!
Studio Effects Devices		CALL!
MIDI Keyboards		CALL!
Drum Machines		CALL!

COMMODORE, IBM AND ATARI ITEMS

CALL!

SILICON EXPRESS DISKS
SS/IDD 8.95
DS/IDD 9.95

VERBATIM OR MAXELL
SS/IDD 13.95
DS/IDD 17.95

ELEPHANT
SS/IDD 11.45
DS/IDD 14.95

DATA CASE
8.95

INSIDE OHIO
1-800-225-0755
YOUR TOLL FREE ACCESS OUTSIDE OHIO
1-800-228-0755
CALL...FOR THE BEST PRICES...
BEST DELIVERY...
We have hundreds of other programs in stock at Fantastic savings.

SILICON EXPRESS

ALL NEW STORE WITH EXPANDED WAREHOUSE

Adventure Const.	30.50	Fantavision	26.95	Mouse Budget	41.00
Algebra I thru IV	27.00	Farenheit 451	22.75	Mouse Calc	91.00
Algebra V & VI	26.95	Fat Cat	18.50	Mouse Desk	23.00
Alpha Plot	34.95	Financial Cookbook	30.00	Mouse File	CALL
A Mind Forever Voy.	18.95	Flex Type	15.50	Mouse Word	78.00
Archon I	24.89	Flight Sim. II	30.50	MouseWrite	71.95
Archon II	22.00	Fontrix	53.25	Most Amazing Thing	22.95
ASC II Express	24.25	Fntpkas 1 thru 13	35.00	Multi Disk Catalog	17.95
Assembly Lines Bk.	16.95	Forecast	15.00	Multiplan DOS 3.3	59.95
Auto Duel	37.95	Font Mechanic	15.00	Munch-A-Bug	23.95
Back-it-up III	42.00	Fontworks	34.95	Murder by the Dozen	21.99
Bag of Tricks #2	28.00	Fraction Factory	18.95	Music Construction	24.50
Bank Blazer	23.50	Fraction Fever	17.95	NATO Commander	19.75
Bank Street Filer	39.50	Frame-Up	15.00	Net Worth	48.89
Bank Street Mailer	39.50	Game Maker	34.95	Newsroom	30.50
Bank Street Writer	39.50	Gato	21.00	One-On-One	24.00
Bank Street Speller	39.50	Gertrude's Puzzles	24.75	PFS: Access	44.00
Baron	27.50	Gertrude's Secrets	24.75	PFS: File	69.95
Beagle Bag	15.00	Goren Bridge	51.95	PFS: Plan	69.95
Beagle Basis	18.50	Ghostbusters	23.00	PFS: Report	69.95
Beagle Graphics	30.50	GI Joe	20.00	PFS: Graph	69.95
Beneath Apple DOS	13.95	Graphics Department	63.95	PFS: First Success	126.00
Bnth. Apl. Pro DOS	13.95	Graphics Expander	22.25	Piece of Cake Math	18.95
Big U	17.00	Graphworks	57.95	Picture Builder	23.99
Black's Law Dict.	64.00	GPLE	25.50	Pinball Construction	21.25
Blazing paddles	27.00	Hacker	27.95	Pitstop II	39.95
Bookends	63.95	Handlers Package	69.95	Pixit	31.89
Bookends Extended	94.95	Hey Diddle Diddle	17.95	Planetfall	22.00
Borrowed Time	22.50	Hitchhiker's Guide	21.75	Practical II	48.95
Breakthru Ardennes	41.95	Home Accountant	47.95	Prince	48.95
Carmen Sandiego	23.00	Homeward +	41.00	Printographer	26.95
Captain Goodnight	20.00	Homeward Filer	41.00	Print Shop	23.75
Chshp. Load Runner	19.85	Image Printer II	34.95	Pr. Shp. Gr. #1,2 or 3	14.25
Chart 'n Graph Tlxb.	23.95	Impossible Mission	23.50	Print Shp. Companion	22.50
Chop Lifter	19.85	Infidel	26.00	Print Shop Refill	12.25
Clip Art Vol. 1	16.25	I.O. Silver	15.00	Probyter	18.50
Clip Art Vol. 2	22.25	Jeeves	29.95	Prof. tour golf	25.89
Complete Graphics	47.89	Juggle's Rainbow	18.95	Pronto DOS	15.00
Copy II +	18.50	Karateka	19.85	Quicken	51.95
Crosstalk	95.00	Kids on Keys	17.95	Rambo	22.50
Crossword Magic	28.50	Kid Writer	18.89	RDF	24.95
Crusade in Europe	23.75	Kinder Comp	17.95	Reach for the Stars	27.50
Crypt of Medea	21.95	Knight of Diamonds	20.50	Reader Rabbit	22.75
Cut & Paste	21.50	King's Quest I or II	28.00	Reforger '88	41.95
Cutthroats	23.69	Koronis Rift	23.50	Rendezvous w/Rama	22.75
Database Toolbox	23.95	Legacy of Llylgamyn	23.50	Report Card	32.95
Dazzle Draw	34.50	List Handler	44.00	Report Works	69.95
D-Code	21.00	Little Comp. People	27.95	Rescue on Fractalus	23.50
Deadline	28.00	Locksmith 6.0	63.95	Rescue Raiders	24.95
Decision in Desert	20.00	Lode Runner	19.85	Robot Odyssey I	27.25
Delta Drawing	27.95	Macroworks	19.95	Rocky's Boots	27.25
DiskQuick	15.50	Magic Spells	20.50	Sargon III	27.25
Dollars & Sense	66.50	Make a Match	18.95	Sat (Harcort Brace)	45.00
DOS Boss	12.25	Man. Your Money	101.95	Science Tool Kit	33.00
Double-Take	18.00	Mask Parade	27.95	Seastalker	22.00
Dragonworld	22.75	Mastering the GRE	104.95	Sensible Grammar	59.95
Early Games	18.95	Mastering the SAT	69.95	Sensible Speller	63.95
Easy as ABC	23.50	Mas. of the Lamps	21.95	7 Cities of Gold	24.25
Eidolon	23.50	Master Type	23.25	Shadowkeep	22.75
Enchanter	23.69	Math Blaster	26.50	Shape Mechanic	20.00
Essential Data Dup	42.95	Math Maze	27.95	Sideways	32.00
Europe Ablaze	30.50	Medical Dictionary	64.95	Silent Service	19.50
Extra K	21.00	Megaworks	69.95	Silicon Salad	12.75
F-15 Strike Eagle	20.00	Merlin	33.75	Skyfox	24.25
Facemaker	17.95	Merlin Pro	55.75	Snooper Trp I or 2	22.95
Family Roots	149.95	Merlin Combo	63.95	Solo Flight	20.00
		Merlin Cookbook	22.25	Sorcerer	26.00
		Micro Cookbook	23.00	Speed Reader II	37.50
		Micro Lg. Baseball	23.25	Spell Breaker	34.95
		Minipix	14.75	Spellcopter	23.50
		Moebius	39.95	Spell It	26.50
		Monty Plays Scrabble	32.95	Spellworks	29.95
				Spitfire Simulator	24.75

Spy Hunter	25.75	Versaform	43.50	Mockingboard D	126.50
Spy vs. Spy	24.95	Video Toolbox	23.95	Mockingboard A-MAX	39.00
Squire	23.25	Visable 6502	31.75	Mltrm CX 256K-16 bit	354.00
Starcross	28.00	Wilderness	38.95	Multiram CX 256K	239.00
Star Lg. Baseball	20.95	Will Writer	27.95	Mltrm CX 512K-16 bit	394.00
Star Trek	25.75	Winter Games	21.50	Multiram CX 512K	279.00
Sticky Bear ABC	23.75	Wisbringer	27.95	Multiram IIE (16 bit)	154.00
Basket Bounce	23.75	Witness	22.00	Multiram RGB 64K	154.00
BOP	23.75	Wizardry	26.50	Multiram RGB 256K	194.00
Car Builder	23.75	Wizard's Toolbox	23.95	Multiram RGB 512K	234.00
Math	23.75	Wizprint	14.25	Multiram RGB 768K	274.00
Numbers	23.75	Word Attack	26.50	Multiram RGB 1024K	314.00
Opposites	23.75	Word Handler	44.00	Multiram IIE 80/64K	124.00
Reading	23.75	Word Perfect	12.95	Multiram IIE 80/256K	159.00
Shapes	23.75	World's Great. Bball	20.00	Multiram IIE 80/152	194.00
Spellgrabber	23.75	World's Great. Fball	23.00	Multiram IIE 80/768	229.00
Town Builder	23.75	Write Choice	26.50	MultiView II + 80/160	199.00
Typing	23.75	Zork I	21.75	Paddlesticks	26.50
Story Machine	17.95	Zork II or III	24.75	Parallel Printer Card	54.95
Story Maker	24.95			Print-it	123.50
Sum. Games I or II	23.00			Prometheus 1200A	255.00
SuperCalc 3A	109.95			Super Serial Card	90.95
Super Disk Copy	24.95			System Saver Fan	59.95
Suspect	26.00			Thunder Clock	103.00
Suspended	28.00			Wildcard 2	74.95
Take 1	34.00			ZEE 80A Checkmate	54.95
Technical Dictionary	39.95			Zoom IIE	109.00
Temple of Apshai Trl.	23.00				
Terrapin Logo	54.50				
Terrapin 10 Pak	177.00				
Think Tank	88.89				
Thinkworks	79.95				
Time is Money	57.50				
Tip Disk #1	12.00				
Transylvania	21.89				
Triple-Dump	20.00				
Turbo Pascal 3.0	35.00				
Turbo Database Tlxb	28.00				
Turbo Tutor	20.50				
Tycoon	23.25				
Typefaces	10.75				
Typing Tutor III	28.50				
Ultima III	33.25				
Ultima IV	39.95				
Understanding IIE	17.95				
Understanding II+	15.95				
Universal file conv	24.95				
Utility City	15.25				

80 Col. 64K Card	49.95	PRINTERS	
Apple Cat II	186.95	Citizen 120D	174.95
Apple Cat 212	352.95	Star SG-10	219.00
Compuserve Starter	21.95	Star NX-10	264.95
Database	8.95	Star SG-15	394.95
Disk Drive Con. Card	47.00	Star SD-10	344.95
Disk Notcher	8.95	Star SD-15	474.95
Essential Data Dup 4+	CALL	Star SR-10	494.95
Flip-n-File	10.95	Star SR-15	594.95
Grappler Buffered	131.00	Star Powertype	344.95
Grappler +	72.00	Okidata 182	229.95
Grappler (serial)	72.00	Okimate 20	209.95
Grappler C	72.00	Okidata 192P	399.95
Hotlink	54.99	Printer Stand	16.95
Koala Pad +	70.50	Colored Printer Rbns	CALL
Kraft Joystick	26.00	Color Paper Pack	13.95
Lemon	31.95		
Lime	48.95		
Mach II II+ Joystick	26.25		
Mach II IIE Joystick	26.25		
Mach III II+ Joystick	32.25		
Mach III IIE Joystick	32.25		
Micromodem IIE	139.95		
Microsci A2 Drive	144.95		
Microsci IIC Drive	149.95		
Mockingboard A	66.00		
Mockingboard B	66.00		
Mockingboard C	116.50		

YOUR ORDER FORM SILICON EXPRESS

5955 E. Main St. Columbus, Ohio 43213

NAME _____

ADDRESS _____

CITY _____ STATE _____ ZIP _____

CHARGE CARD # _____ Exp. Date _____

QTY.	DESCRIPTION	PRICE

Computer Type _____ SHIPPING _____

Phone No. _____ TOTAL _____

No additional surcharge on Mastercard, Visa, or School purchase orders. Personal checks allow 2 weeks. Shipping charges are \$3.00 minimum. Ohio residents add 5 1/2% state sales tax. Prices subject to change without notice.

CIRCLE 231 ON READER SERVICE CARD
SILICON EXPRESS
5955 E. Main St. Columbus, Ohio 43213
1-614-868-6868



BUSINESS COMPUTERS

OF PETERBOROUGH Gollan Co., Inc.

Upper Union St. P.O. Box 94
W. Peterborough, NH 03468-0094

Absolutely
No Additional
Charges *

“We will match any mail order price in this issue.”

“Our prices hide nothing” *

William F. Gollan
President

“We'll support, service, and warranty everything we sell and stand behind it 100%.”

MODEMS			
DC. Hayes		Prometheus	
Micro Modem Ite SW	144.95	Pro 1200	289.95
Smart 1200	369.95	Pro 1200 A w/sc	264.95
Smart Modem 2400	584.95	Pro 300C	129.95

PERIPHERALS			
Apple		Kraft	
II E's & II C's & Macs	CALL	Kraft Quickstick	37.95
Checkmate Tech		Kensington	
Multiram II E 64K + 80	129.95	Printer Stand	19.95
Multiram II E 256K + 80	169.95	System Saver	64.95
Multiram II E 512K + 80	209.95	Koala Technologies	
Multiram IIE 1024KRGB + 80	309.95	Koala Pad +	75.95
Multiram IIE 1792KRGB + 80	499.95	Orange Micro	
Multiram IIE w/VP	249.95	Grappler +	79.95
Multiram II CX w/256K	209.95	Grappler + w/64k	154.95
Multiram II CX w/512K	249.95	Grappler + RS-232C	79.95
Multiram II CX16 w/256	329.95	Grappler C	84.95
Multiram II CX16 w/512	379.95	Hot Link Iic	54.95
Multiram CX16 Kit w/VP	219.95	Image Buffer II w/64k	74.95
Curtis		Ribbons	
All Products	CALL	All Printers	CALL
Disks		Textprint	
BASF SS/DD	15.95	Print It	129.95
Maxell MD1 SS/DD	18.95	Thirdware	
Memorex SS/DD	18.95	Fingerprint +	94.95
Verbatim Bonus SS/DD	14.95	Fingerprint + Ilic	94.95
Verbatim Datafiles SS/DD	19.95	Titan	
Joysticks		Accelerator	224.95
Hayes Mach III's	37.95	128k Ram	179.95

PRINTERS DOT MATRIX			
Apple		FX 286	
Imagewriter II 10"	CALL	LQ 800	589.95
Citizen		LQ 1000	699.95
MSP 120D	209.95	Okidata	
MSP 10 160	309.95	ML 192	349.95
MSP 15 160	429.95	ML 192 Image.	379.95
MSP 20 200	359.95	ML 193	484.95
MSP 25 200	529.95	ML 193 Image	554.95
MSP 35 Premier	509.95	Silver Reed	
Epson America		Exp 400	219.95
AP 80 Image	279.95	Exp 500	239.95
LX 80	249.95	Exp 550	369.95
LX 80 FT	279.95	Exp 800	669.95
FX 85	409.95		

BUSINESS SOFTWARE			
ALS		Kensington	
Spellworks	34.95	Format II	91.95
Apple		Living Videotext	
Appleworks	194.95	Think Tank	82.95
Arrays		Megahaus	
Appleworks Buddies	55.95	MegaWorks	74.95
Home Accountant	47.95	Report Works	74.95
Tax Advantage	44.95	Microsoft	
BPI Software		Multipan	60.95
AR, GL, PR, AP, IC (ea)	199.95	Monogram	
Prodos Versions (ea)	209.95	Dollar & Cents	61.95
Broderbund		Dollars & Cents Iic	71.95
Bank Street Files	44.95	Forcast	41.95
Bank Street Mailer	44.95	Peachtree	
Bank Street Speller	44.95	Back to B. AR,AP,GL (ea)	64.95
Bank Street Writer	44.95	Back to Basics	109.95
Compuserve		PBI	
Subscription Kit	20.95	JEEVES	41.95
Howardsoft		Graphworks	63.95
RE Analyzer	194.95	Quark	
Human Ed		Catalyst 3.0	64.95
Mind Prober	34.95	Word Juggler 3.0	134.95
Int'l Solutions		Roger Wagner	
Mouse Budget	59.95	Mouse Write	77.95
Mouse Calc	109.95	Sensible Software	
Mouse Desk	39.95	Graphics Dept.	72.95
Mouse Word	94.95	Sensible Grammar	59.95
Intuit		Sensible Speller IV	72.95
Quicken	54.95	Sierra On Line	

BUSINESS SOFTWARE			
Homework +	47.95	Super IIIA	104.95
Home Word Filer	47.95	SSI	82.95
Software Publishing		Word Perfect	82.95
PFS: WR,GR,RP,PL (ea.)	73.95	United Software	
Sorcim/US		ASCii Express	79.95

UTILITIES & LANGUAGES			
Activision		Broderbund	
Kitchen's Game Maker	34.95	Dazzle Draw	40.95
Baudville		Print Shop	31.95
Actors & Actions	21.95	Print Shop Companion	27.95
Business	33.95	Print Shop GL 1.2,3 (ea)	19.95
Blazing Saddles	30.95	Print Shop Refill Paper	17.95
Heroes & Villans	21.95	Central Point	
Pixit	35.95	Copy II +	24.95
Prince Color (Epson)	47.95	Data Transforms	
Prince Color (Prowriter)	154.95	Fontrix	58.95
Shape Lib. 1.2,3 (ea)	13.95	Font Set(s) (ea)	16.95
Take 1	36.95	Electronic Arts	
Beagle Brothers		Adv. Const. Set	35.95
Apple Plot	27.95	Music Const. Set	29.95
Apple Mechanic	20.95	Pinball Const. Set	27.95
Bag	20.95	Racing Dest. Set	CALL
Basic	23.95	Funk	
Big U	22.95	Sideways	37.95
D-Code	27.95	Microsoft	
Diskquick	20.95	Fortran-80	129.95
DOS Boss	17.95	Mindscape	
Double-Take	23.95	Mister Pixel's	23.95
Extra K	26.95	Cartoon Kit	23.95
Fat Cat	23.95	Paint Set	23.95
Flex Text	20.95	Color Me (Main)	23.95
Font Mechanic	20.95	Hugga Bunch	10.95
Frame-Up	20.95	Rainbow Brite	10.95
GPLE	30.95	Shirt Tales	10.95
Graphics	35.95	Shk Tonk	10.95
I.O. Silver	20.95	Pinpoint	
Macro Works	23.95	Pinpoint	39.95
Mini Pix #1	19.95	Pinpoint Ram Exp.	13.95
Pro-Byter	23.95	Pinpoint Spellchecker	39.95
Pronto DOS	20.95	Pinpoint Toolkit	39.95
Shape Mechanic	25.95	Roger Wagner	
Silicon Salad	17.95	Merlin Assembler	40.95
Tip Disk # 1	13.95	Merlin Combo	69.95
Triple Dump	25.95	Merlin Pro	61.95
Typefaces	15.95	Springboard	
Utility City	20.95	Graphic Expander VI	27.95
Borland International		Newsroom Clip Art V1	22.95
Turbo Pascal 3.0 (Reg. CPM)	40.95	Newsroom Clip Art V2	26.95
Turbo Tool (Reg. CPM)	34.95	The Newsroom	35.95
Turbo Tutorial (Reg. CPM)	25.95	Terrapin	
		LOGO	59.95

EDUCATIONAL & PERSONAL			
Accolade		Countdown to Shut.	
Hard Ball	24.95	Designer's Pencil	27.95
Laws of West	24.95	Ghostbuster's	27.95
Psi 5	24.95	H.E.R.O.	27.95
Sundog V 2.0	27.95	Master Lands	27.95
Access		Mindshadow	27.95
Beach-Head I,II (ea)	26.95	Pitfall	27.95
Activision		Road Race	27.95
Alcazar	27.95	Rock N Bolt	27.95
Borrowed Time	27.95	Space Shuttle	27.95

MONTHLY SPECIAL

Checkmate Tech

- Multiram II E 64K + 80 129.95
- Multiram II E 256K + 80 169.95
- Multiram II E 512K + 80 209.95
- Multiram II E 768K + 80 249.95
- Multiram II E 64K RGB + 80 179.95
- Multiram II E 512K RGB + 80 229.95
- Multiram II E 1024K RGB + 80 309.95
- Multiram II 1792K RGB + 80 499.95
- Multiram II EX w/VP 249.95
- Multiram II CX w/256K 209.95
- Multiram II CX w/512K 249.95
- Multiram II CX16 w/256 329.95
- Multiram II CX16 w/512 379.95
- Multiram CX 16 Kit w/VP 219.95

+ 2.50 S&H

EDUCATIONAL & PERSONAL			
Tracer Sanction	27.95	Bank St. Story B.	29.95
Zenni	27.95	Crossword Magic	33.95
Avant Garde		Deja Vu	39.95
Dave Winfield	27.95	Forbidden Castle	30.95
Barrons		Halley Project	31.95
Computer SAT	56.95	James Bond View K.	27.95
Blue Chip		Keyboard Cadet	29.95
Barron	29.95	Lusher Profile	29.95
Millionaire	29.95	Perfect Score	46.95
Squire	29.95	Racter	32.95
Tycoon	29.95	Rambo Part II	27.95
Broderbund		Stephen King Mist	27.95
Captain Goodnight	25.95	Tink's Adventure	22.95
Championship Lode R.	24.95	Tonk in Buddy Bots	22.95
Choplifter	24.95	Tuk Goes Town	22.95
Fantavision	32.95	Tinka's Mazes	22.95
Karateka	24.95	Tinka's Sub. Fair	22.95
Mask of Sun	27.95	Voodoo Island	27.95
Serpent's Star	29.95	Onestep	
Where in the World	28.95	Golfs Best Pinhurst	35.95
CBS		Golfs Best St. Andrews Old	35.95
Goren's Bridge	53.95	Origin	
Mastering SAT	61.95	Autoduel	37.95
Murder by Doz.	27.95	Moebius	42.95
Datsoft		Ultima 3 & 4 (ea)	39.95
Alternate Reality	30.95	Penguin	
Bruce Lee	27.95	Coveted Mirror	25.95
Conan	27.95	Crimson Crown	25.95
Dig Dug	21.95	Pinpoint	
Goonies	28.95	Added Menu's (ea)	13.95
MacMan	21.95	Micro Cookbook	27.95
Zoro	28.95	Randow House	
Davidson Associates		Charlie Brown's ABC's	29.95
Alge Blaster	32.95	More Products	CALL
Classmate	31.95	Snoopy Rescue	29.95
Math Blaster	31.95	Scarborough	
Speed Reader II	42.95	Boston Diet	50.95
Spell It	31.95	Build a Book	28.95
Word Attack	31.95	Build Refills 1,2 (ea)	16.95
Electronic Arts		Masteryte	
All products	CALL	Figures & Formulas	21.95
Epyx		Filer	28.95
Baseball	25.95	New Improved	28.95
Crush, Crumble	20.95	Writing Wizard	53.95
Football	28.95	Personal Net W.	51.95
Koronis Rift	29.95	Run for the \$	28.95
Pitstop	28.95	Songwriter	28.95
Summer Games	28.95	Sierra On Line	
Summer Games II	28.95	Black Calderon	29.95
Temple Apshear	28.95	King's Quest I,II (ea)	33.95
Winter Games	26.95	Simon & Schuster	
Hayden		Holy Grail	32.95
Sargon III	32.95	JK Lasser's Mng.	54.95
SAT Math	36.95	Typing Tutor III	33.95
SAT Verbal	36.95	Sir Tech	
Infocom		Rescue Raiders	27.95
All products	CALL	Wizardry 1	31.95
Learning Company		Wizardry 2	25.95
Addition Magician	26.95	Wizardry 3,4 (ea)	28.95
Gertrudes Puzzle	29.95	Spectrum	
Gertrudes Secrets	29.95	Gato	27.95
Juggle's Rainbow	23.95	Spinnaker/Telarium	
Magic Spells	25.95	Alphabet Zoo	21.95
Moptown Hotel	29.95	Amazon	27.95
Moptown Parade	29.95	Delta Drawing	27.95
Number Stumper	27.95	Dragon World	27.95
Reader Rabbit	27.95	Fahrenheit 451	29.95
Robot Odyssey	32.95	Homework Math/Word	29.95
Rocky's Boot	32.95	In Search of	25.95
Word Spinner	25.95	Kids on Keys	19.95
Meca		Kindercomp	19.95
Managing Your \$	107.95	Math Busters	23.95
Micro Lge. Sports		Rendezvous w/Rama	27.95
Baseball	29.95	Shadow Keep	27.95
Microprose		Snoopy Trooper 1,2 (ea)	24.95
Crusade in Europe	28.95	Story Machine	27.95
Decision Desert	28.95	Strategic Simulations	
F-15 Strike	25.95	All products	CALL
NATO Commander	25.95	Sublogic	
Silent Service	25.95	Flight Simulator II	34.95
Solo Flight	25.95	Xerox/Weekly Reader	
Mindscape		Sticky Bear Series (ea)	29.95
Bank St. Music	37.95		

Customer Service (603) 924-9406

- * Our Terms and Conditions
- * Shipping UPS: Incl. in our price
- * Handling: Incl. in our price
- * Credit Card Surcharge: 0%
- * Purchase Orders: FOB NH, and handling.

- FREE CREDIT CARD USE
- FREE SHIPPING
- FREE HANDLING

CALL TODAY—ORDERS ONLY 1-800-845-3003



Speaking of Graphics

BY ROBERTA SCHWARTZ AND MICHAEL CALLERY

GRAPHICS PROGRAMS FOR KIDS

Rainbow Painter, Picture Writer, Color Me, and Designer's Pencil

Graphics programs are wonderful tools for introducing children (and adults) to computers, and a gaggle of Apple II graphics programs are intended for young people. This month, we look at four of them.

Rainbow Painter

This full-featured paint utility operates with a joystick or with the keyboard. The program opens with a colorful screen of icons (see figure 1). Click on Playground to draw on a blank screen, Mirrors to create kaleidoscope-type images, or any of the other ten icons to open "books" of predrawn black-and-white images for coloring.

Once you've made your selection, the "playground" appears, with icons at the bottom of the screen. Clicking on the rabbit in a hat opens a window of drawing options such as line, box, and so on. The crayon icon opens a box of 49 brushes to paint with, plus FILL (see figure 2). A paint-bucket icon lets you cycle through 99 colors and patterns, and the book icon pages through the four images in your selected coloring book.

Other icons allow you to edit patterns; undo your last move; access new picture libraries; and load, save, and print pictures.

Rainbow Painter offers as many options as most "adult" graphics programs do. It is a wonderful program for any child—up to the age of 90.

Picture Writer

Picture Writer, comparable to Penguin Software's Graphics Magician (see "The Graphics Magician," A +,

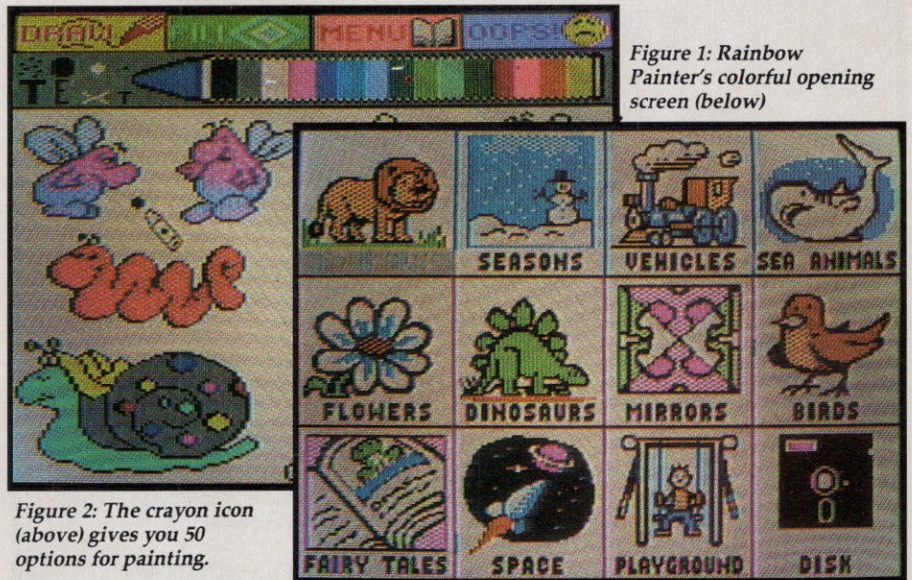

Figure 1: Rainbow Painter's colorful opening screen (below)

Figure 2: The crayon icon (above) gives you 50 options for painting.

May 1984, and "Seeing Double," A +, January 1985), records the steps you use in creating a graphic. The program then redraws the completed picture, step by step. You can store finished pictures as "process" pictures (in which the drawing steps are

Rainbow Painter is a wonderful program for any child—up to the age of 90.

saved) or as standard 34-sector pictures.

As you draw with Picture Writer, you can compose music. Pressing M plays a note for most drawing steps. The higher the step is on the screen, the higher the note. In the Music

mode, R redraws the picture with the music accompaniment. Young people can have fun drawing designs that play distinctive tunes.

Unfortunately, we can't recommend Picture Writer. The menu icons are too small, and the user interface is cumbersome. Instead of selecting an icon with the joystick, you must use the keyboard—e.g., C for color, then 5, and 5 again for solid blue. Five for blue? Apple colors have numbers: 1 is green, 6 is blue, and so on. Every graphics program we've seen adheres to this scheme. If they must use numbers to select colors, we'd want our children to learn Apple's numbers.

If you want to introduce children to step-by-step drawing, show them the professional's Graphics Magician—it may not have music, but it's easier to use than Picture Writer.

Color Me

With an enhanced Apple IIe or a IIc and a joystick, KoalaPad, or mouse, even very young children can

experience the joy of using red, yellow, and 14 other colors, with Color Me, a double-hi-res graphics program.

The palette, one of the cleverest we've seen, is displayed as a striped crayon. Selecting a colored stripe chooses the drawing color, and the tip of the crayon changes to that color. You use the crayon to draw, fill, and enter text. Other options include Undo, Magnify, Cut and Paste, and Print.

For a children's program, Color Me

*Color Me's palette,
one of the cleverest
we've seen, is
displayed as a
striped crayon.*

packs a surprising wallop: It includes two active graphics pages to allow easy cutting and pasting between different pictures. This feature, com-

bined with supplemental Color Me picture disks, encourages kids to put together good-looking pictures.

Color Me is a wonderful program for children (assuming the adults are finished playing with it).

Designer's Pencil

Designer's Pencil is a graphics programmer's toolkit, not a paint program. It features more than 30 commands that, when you put them in the right order and give them the correct parameters, produce a graphic. The program draws the pictures as you watch. The range and power of Designer's Pencil is impressive. It has commands to draw lines, arcs, and circles; fill; make kaleidoscopes; alter the speed of drawing; and so on. The program also includes simple music commands.

Like many programs that were originally created for Atari or Commodore computers, Designer's Pencil was designed to work with switch-style joysticks (up, down, left, right), rather than the Apple joystick's rheostat mechanism. Therefore, using an Apple joystick is awkward. If you don't have a joystick attached to your computer, you can use the keyboard, but if a joystick is attached, the program automatically accesses it. We would have preferred an option to select keyboard input, even if a joystick were connected.

The user interface is clumsy. The screen is divided into four major areas, and to move from one section of the screen to another, you must position your cursor correctly. For example, you must enter the master command area from the middle of the screen. To enter a command into the programming area, you select it from the rightmost window. Moving from window to window is distracting. Also, you don't see the results of your program until you enter the master command area and issue a RUN command—novices will have trouble conceptualizing the results of command arguments.

The programming language of Designer's Pencil includes variables, labels, GOTOs, and recursion. The instruction manual describes the language features, but we doubt that a child or a beginner could tap its power without a lot of work.

We like the idea of using graphics to teach programming, but such an effort might better be directed at learning BASIC or Instant Pascal; with these languages you can see the

PRINT-QUICK™

5 essential printer support utilities in one easy-to-use product

WHY PURCHASE SEPARATE PRODUCTS AT GREAT EXPENSE WHEN PRINT-QUICK DOES IT ALL AND DOES IT BETTER?

A "MUST" FOR EVERY SOFTWARE LIBRARY!

QUICK-SETUP: Easily control ALL printer features including International Characters, Page Length, Skip-Over-Perf, Left Margin, and Horizontal Tabs. Download and select supplied Customer Character Sets. Save frequently used setups to EXECable Setup Files.

QUICK-TYPER: A full featured one-line-at-a-time text editor that can imbed print feature commands *within* a line. Text may be sent right to the printer or to a standard text file. Wonderful for labels and quick memos! Unique Preview Line feature makes learning the fanciest printing techniques easy!

QUICK-DUMPER: Simply the best and the easiest-to-use Hi-Res screen printer around! Use the Quick'N'Easy Mode for one button screen printing or go into Total Control to select your own print parameters. Print all or just part of the Hi-Res screen with super easy keyboard, joystick or mouse cropping. Quick-Dumper always tells you the size of your picture before you print it!

QUICK-FONT: The finest Downloadable Character Set Designer/Editor available! Four character sets included on the disk. Use the special graphics character set with Quick-Typer or your favorite word processor to create custom business forms.

TEXT FILE UTILITIES: Print text files or display them on the screen with all hidden command characters revealed!

OVER 30 DETAILED HELP SCREENS and a **QUICK REFERENCE CARD** allow immediate use of PRINT-QUICK supporting the fine 150 page three-ring bound Owner's Manual.

PRINT-QUICK SUPPORTS: The Sider Hard Disk Drive (and other DOS 3.3 volume oriented hard disks), Apple compatible 80 column cards and RAM cards, Apple compatible clock cards, the Apple Mouse, and the Mockingboard.

PRINT-QUICK RUNS on the entire Apple II Family.

PRINT-QUICK supports printers made by Apple Computer, Citizens, C. Itoh, Epson, Okidata, NEC, Star Micronics and their compatibles.

Ask your local dealer for PRINT-QUICK. Feel free to call us at (216) 671-8991 at any time to find out more about PRINT-QUICK (or call 1-800-233-WAVE and place an order! MC & VISA accepted).

PRINT-QUICK,
only \$49.95

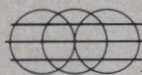

THIRD WAVE TECHNOLOGY INC.

TM

11934 Lorain Ave. • Cleveland, OH 44111

PRINT-QUICK, QUICK-SETUP, QUICK-FONT, QUICK-TYPER, QUICK-DUMPER and THIRD WAVE TECHNOLOGY are trademarks of Third Wave Technology, Inc. Apple is a reg. TM of Apple Computer, Inc. Mockingboard is a reg. TM of Sweet Micro Systems, Inc. Sider is a reg. TM of First Class Peripherals.

CIRCLE 145 ON READER SERVICE CARD

PRINT-IT!™

THE NEW APPLE* COMPATIBLE SERIAL AND PARALLEL PRINTER INTERFACE

IMAGE WRITER II
COLOR COMPATIBLE



Go
From Screen
to Paper
at the Touch
of a Button!

The ONLY way to get fast, easy printouts
of ANY screen, at ANY time,
with ANY program.

Push the red button that comes with PRINT-IT! - Your program pauses instantly; touch RETURN and whatever is on your screen - text, graphics or both - is printed in color or black & white.

Whether your Apple II, II+, //e[®] or "look-alike" is for business or pleasure, you'll want the ability to pause and take snapshots of your screen displays and then continue from exactly where you paused, all at the touch of a button - games, business data, menus, educational instructions, graphics - even CP/M[®]. PRINT-IT! will print your screen at any time no matter what program you're running, as well as perform every function you expect of an intelligent printer card.

PRINT-IT! supports:

- Graphics - Low, high, double low, and double high resolution
- Text - 40 column as well as Apple //e and Videx[®] 80 column cards including the new Apple 80 column RGB card
- Software - Prints from ALL software, even allows any printer to be used directly from Apple MousePaint
- Printers - All of the most popular printers,[®] including color, are easily selected with a dip switch.

PRINT-IT!, complete with cable (serial or parallel), is available at your local computer store now! If they don't have it in stock, ask them to get it for you.

Can't find a local dealer? PRINT-IT! is available for \$199 directly from Texprint[®] Qualified educational and dealer discounts available.

TEXPRINT

Subsidiary of Computer Products Inc.
220 Reservoir Street
Needham Heights Ma. 02194
Tel. (617) 449-5808

For information call Toll Free **1-800-255-1510**

① Visa, MC, AMX accepted. Add \$4 shipping and handling within USA. Mass res. add 5% tax
② Apple II, II+, //e, and MousePaint are registered trademarks of Apple Computer, Inc.
③ CP/M is a registered trademark of Digital Research
④ Videx is a registered trademark of Videx, Inc.
⑤ Apple DMP/IMAGEWRITER/SCRIBE, BMC, C. Itoh, Canon, Epson, Dataproducts, IDS, Tally, NEC, Okidata, Quadram, Panasonic, Radio Shack, Star Gemini, Transtar, Diablo plus many others.

CIRCLE 343 ON READER SERVICE CARD

Turn your Apple into a CAD workstation for just \$99

Finally computer-aided design is affordable...with the popular CADAPPLE-Entry Level software package. Among its professional features are:

- Easy "menu" structure and single keystroke operation
- Full "floating point" internal calculations for unlimited zoom—a true CAD system
- Automatic dimensioning, built-in primitives including ellipses and polygons, multiple drawing layers, dual "snap" modes, independent X-Y grids, text at any angle
- Interactive graphics so your drawing changes visibly as you work, including scale, rotate, etc.

In addition to the complete CAD software, you'll receive an audio tour on cassette tape to help get you started...the 170-page CAD-TUTOR training manual including drawing exercises...function key overlay...and a fully-illustrated reference manual. The CADAPPLE program is used daily in thousands of schools and businesses around the world for computer-aided design.

Call today **1-800-228-2028, Ext. 82** with VISA or MasterCard

(or send check or M.O. for \$99 to T&W Systems, 7372 Prince Dr., Huntington Beach, CA 92647. Calif. add 6% sales tax.)

Runs on Apple II series with 64K, 2 disk drives. Supports joystick, Apple mouse or Koala pad. Output to Hewlett-Packard, Apple or Houston Instruments plotters using Apple Super Serial card or Apple IIC serial port.

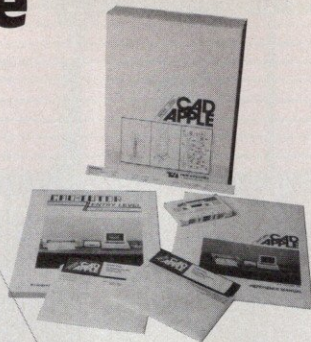

CIRCLE 102 ON READER SERVICE CARD

Attention all FX80, FX100, JX, & RX owners: You already own half of a great printer

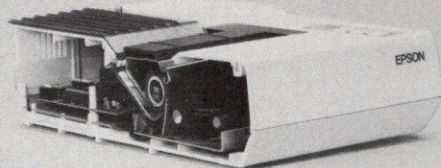

**Now
Only
\$79.95**

Now for \$79.95 you can own the rest. You see, today's new dot matrix printers offer a lot more.

Like an NLQ mode that makes their letters print almost as sharp as a daisy wheel. And font switching at the touch of a button —

in over 160 styles. But now, a Dots-Perfect upgrade kit can make your printer work like the new models in minutes. At a fraction of their cost.

Call now and use your Visa or Master Card. Don't replace your printer, upgrade it!

1-800-368-7737

In California: 1-800-831-9772

g Sample of letter with Dots-Perfect

Dots-Perfect

Dresselhaus

Sample of letter without Dots-Perfect

837 E. Alost Ave., Glendora, CA 91740 Tel: (818) 914-5831

An upgrade kit for EPSON FX, JX and RX printers

CIRCLE 339 ON READER SERVICE CARD



EPSON is a trademark of EPSON America, Inc.

results of an instruction immediately. With a better interface and an Immediate mode, Designer's Pencil could be a contender.

Encourage Creativity

We're delighted to see so many graphics programs for young people. Most of these programs provide pictures for coloring. Let your children and/or students use these to become comfortable with the computer and the software. Then, for maximum creative development, we hope you'll encourage them to use the drawing tools to create original images.

Coming Up

Next time we'll look at some excellent new products for your graphic excursions on the Mac, including PictureBase, PosterMaker, 4Paint, and PacPaint. **+**

PRODUCT INFORMATION

Color Me

Mindscape, Inc.
3444 Dundee Road
Northbrook, IL 60062

List Price: \$29.95; Color Me Picture Disks (Color Me Rainbow Brite, Color Me Shirtsails, Color Me Hugga Bunch, and Color Me Tink Tonk), \$9.95 each

Requires: Apple IIe or IIc; 128K RAM; joystick, KoalaPad, or mouse

CIRCLE 370 ON READER SERVICE CARD

Designer's Pencil

Activision
P.O. Box 7287
Mountain View, CA 94039
(418) 960-0410

List Price: \$39.95

Requires: Apple II, II Plus, IIe, or IIc
CIRCLE 371 ON READER SERVICE CARD

PictureWriter

Scarborough Systems, Inc.
25 North Broadway
Tarrytown, NY 10591
(914) 332-4545

List Price: \$29.95

Requires: Apple II Plus, IIe, or IIc;
64K RAM; joystick or KoalaPad
CIRCLE 372 ON READER SERVICE CARD

Rainbow Painter

Springboard Software, Inc.
7808 CreekrIDGE Circle
Minneapolis, MN 55435
(612) 944-3912

List Price: \$34.95

Requires: Apple II Plus, IIe, or IIc;
64K RAM

CIRCLE 373 ON READER SERVICE CARD

JE520 Voice Synthesizer
for Apple II, II+ and IIe
JE520AP... \$119.95
JE523TS (Software) \$ 9.95

JE614 Numeric Auxiliary Keypad
for Apple IIe*
JE614... \$49.95

12" Monochrome Monitor
for Apple II, II+ IIe and IIc
AMON... \$99.95

Joystick
for Apple IIe
AJS-1... \$19.95

Joystick
for Apple II, IIe and IBM
UJS-1... \$29.95

Add'l. Apple Compatible Products

Cooling Fan
for Apple II, II+ and IIe
APF-1... \$39.95

Switching Power Supply
for Apple II, II+ and IIe
KHP4007... \$39.95

Parallel Printer Interface
for Apple IIc
MW-100... \$69.95

VERSACARD
for Apple II, II+ and IIe
VERSACARD... \$169.95
(Serial, Parallel, Clock/Calendar and BSR)
PM-SC (Serial Cable)... \$24.95
PM-PC (Parallel Cable)... \$24.95

Mail Order Electronics - Worldwide
Jameco ELECTRONICS
Serving the Computer Enthusiast Since 1974
©1986 Jameco Electronics

QUALITY COMPUTER PRODUCTS FOR APPLE II, II+, IIe, IIc and Macintosh*

1MByte RAM Card
for Apple II, II+ and IIe*

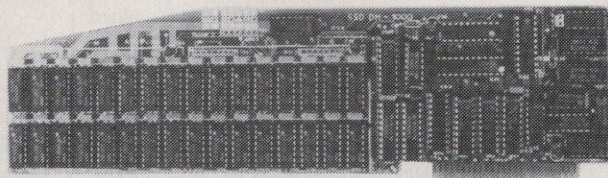

Introducing a third generation memory card that gives you both great expandability and great versatility at an extraordinary price. **Versatility to users** means that BIG BOARD is compatible with software written for the Synetix SSD (Flashcard) as well as for Jameco's JE868 128K RAM Card. Big Board makes available 426K of worksheet space, using the program THE Spreadsheet Version 2.0. It is compatible with PLUSWORKS XM for running Appleworks on the Apple II. Versatility also means that BIG BOARD comes complete with RAMDISK software for DOS 3.3, ProDOS, Pascal 1.2, and CP/M for Microsoft's Softcard. A separate driver is available for the AppliCard (StarCard). **Versatility to programmers** means that you can choose the active addressing mode both via a jumper on the BIG BOARD or through software commands. Choose the mode that is most convenient for you in developing your application. The byte addressing mode has no conflicts with your use of the standard language card or IIe auxiliary slot memory card. The bank switched addressing mode shares the language card area and serves you well as a location for running code. Thanks to a low power design, this 1 megabyte configuration draws less than 470mA. Manual included.

BIG BOARD-256K 256K RAM... \$224.95
BIG BOARD-512K 512K RAM... \$269.95
BIG BOARD-1M 1Meg RAM... \$299.95

APPLE™ Compatible 5¼" Disk Drive and Controller Card
for Apple II, II+ & IIe*



• Belt-driven • 143K formatted storage
• Color matches Apple Computer
• Works with Apple Controller or other Apple-compatible controllers (JE875)
• Complete with connector - just plug into your disk controller card
• 35 tracks • Size: 8" W x 3½" H x 8-9/16" D • Weight: 4¼ lbs.

ADD-514 (Disk Drive) \$129.95
JE875 (Controller Card) \$49.95

APPLE™ Compatible 5¼" Half-Ht. Disk Drive
for Apple II, II+ & IIe*



• Direct drive • 143K formatted • 35 tracks • Super quiet • Works with Apple Controllers or other compatibles (JE875) above • Complete with connector-just plug into your controller • Size: 5¼" W x 1½" H x 8" D • Weight: 4 lbs.

ADD-12... \$119.95

APPLE™ IIc Compatible 5¼" Half-Ht. Disk Drive
• Same specs as ADD-12 (above) except no controller necessary.
ADD-IIc... \$129.95

Z-Engine CP/M Interface Card
For Apple II, II+ and IIe*

Advanced Logic Systems



The Z-Engine is an economical and reliable CP/M interface card that adds the CP/M 80 operating system to your Apple Computer.
• Z-80A microprocessor with CP/M 2.2 operating system and utilities • Follows Apple II Pascal Protocol • Incl. CP/M 2.2 Software • Utilities are menu-driven • Warm-boot without reset • Auto. 80-column board and printer configuration • Manual included
Z-Engine... \$139.95

80-Column Card
For Apple II, II+ and IIe*



The Smarterm II Interface Card for Apple II, II+ and IIe provides your video monitor with an 80-column screen display, plus the 40-column Apple II display. Smarterm II understands the standard Applesoft, Integer BASIC, and Apple Pascal commands and programs. Smarterm II also adds special punctuation characters.
Smarterm II... \$139.95

NEW! VHF/Computer Interface
for Apple II, II+ and IIe, IIc and Franklin Ace†

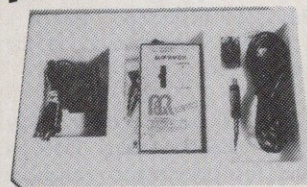

An electrically safe, high performance VHF Interface to convert a home TV into a full video display for a personal computer, CCTV camera, or sim. systems.
• FCC APPROVED
• Compatible with color or B&W TVs
• Complete with matching video cable, wall transformer, and impedance matching transformers

† Also compatible with IBM PC and compatibles (with Color Graphics Board).
SUP'RMOD... Suggested List \$69.95 \$24.95

CIRCLE 279 ON READER SERVICE CARD

\$20.00 Min. Order - U.S. Funds Only Send \$1.00 Postage for your Calif. Residents Add 6% or 6½% Sales Tax FREE 1986 Jameco Catalog Shipping - Add 5% plus \$1.50 Insurance Prices Subject to Change Send S.A.S.E. for Quarterly Sales Flyer!



1355 SHOREWAY ROAD
BELMONT, CALIFORNIA 94002
Phone Orders Welcome (415) 592-8097
Telex No. 176043

7/86 *APPLE, APPLE II, II+, IIe, IIc and Macintosh are registered trademarks of APPLE Computers

APPLE* Compatible Cards
For Apple II, II+ & IIe*
Made in U.S.A.!

128K RAM Card
JE868**... \$119.95

Applesurance Diagnostic Disk Controller Card
JE877... \$69.95

Parallel Printer Card
JE880... \$59.95

Parallel/Serial 64K Buffer Card
(Attaches to JE880 above)
JE883... \$79.95

16K RAM Card
For Apple II and II+
JE860... \$39.95

Extended 80-Column Card
Apple IIe
JE864... \$69.95

**When using CP/M, the JE860 and JE868 will only function with Version 2.20 or earlier; PASCAL (JE868) Version 1.1 or earlier.

Artificial Intelligence Update

Transform Your Macintosh Into A Powerful A.I. Workstation For Less Than \$500 ... And Make It Fly ! *

In 1983, I was developing an expert system tool in LISP (the *defacto* standard). It was a shock when I encountered a true LISP workstation - both the price (\$100,000) and its capability (phenomenal !!). I rushed out and bought one, and it immediately justified the expense. My code development speed increased 10 TIMES because of the incremental compiler, integrated editor, and rich environment. But I also wanted to deliver my completed application. In 1984 Apple answered my prayers by giving us the Mac!

This tool had a powerful 68000, windows, a mouse, menus; in short, all of the things I was used to on my LISP machine, **except LISP!** I realized that until I had a good LISP on the Mac, I was limited in what I could accomplish. With a team of skilled LISP programmers, we started to create a powerful development environment for the Mac, with an incremental native code compiler, macros, multiple edit windows, automatic matching parenthesis and indentation. Along the way we added control of the Mac toolbox, 3-D graphics with perspective, spherical graphics and an object oriented SmallTalk like class system. The result is an incredible environment that rivals features found ONLY on \$100,000 systems, and is available today at microcomputer prices of less than \$500.

Our next task was to port across expert system tools to the **ExperLisp** environment. With the help of Science Applications, the 3000+ lines of LISP source code in OPS5 was running in less than two weeks, and *outperformed* a \$30,000 workstation. **ExperOPS5+** is now available with a user interface that includes dialog boxes and pictures for less than \$500! Next was another powerful expert system builder called **ExperFacts**. It can chain both *forwards and backwards*.

If all of this just seems too good to be true, just remember how far technology has come. The \$100,000 system has 2MB of memory. Amazing! But not as amazing as the MacPlus; it has 1MB to 4MB of memory for 1/20 of the price!

The future of Artificial Intelligence is just starting today. This revolution will only succeed if hundreds of thousands of

professionals encapsulate their expertise into expert systems. This requires powerful A.I. development tools on microcomputers. We have delivered these tools now, the rest is up to you. The only limitations now are the experts. Not just LISP programmers and knowledge engineers, but also accountants, lawyers, architects, engineers and other professionals.

Hundreds of simple expert systems with 50 to 1500 rules are begging to be developed NOW. Already, our users are working on a medical advisor, maintenance systems ..., etc. Most of them have NO previous A.I. or programming experience, but using **ExperOPS5+** they have been able to understand and develop expert systems rapidly.

Denison Bollay,
Founder and President,
ExperTelligence, Inc.

ExperTelligence Takes the Lead in Lisp Workstations

SANTA BARBARA, Ca. - ExperTelligence announced today that it has sold more LISP compilers than any other A.I. vendor. Additionally, the company announced that its expert system shell **ExperOPS5** has been sold to more than 1000 customers. This is a larger installed base of users than all of the other A.I. vendors combined.

Headquartered in Santa Barbara, the publicly held company has pioneered many firsts in the industry: the first incremental compilers on the Mac (**ExperLogo** in '84,

ExperLisp in '85); the first 3-D tools (with automatic perspective) and spherical graphics embedded in Lisp and Logo; the first complete expert system shell on a microcomputer (**ExperOPSS**, developed in **ExperLisp** by Science Applications International). Soon to be announced the first **CommonLisp** compiler for the Mac.

Prolog II : The Real Thing

MARSEILLES, France - PrologIA announced that it has chosen ExperTelligence, Inc. to distribute its famous PrologII in the U.S. Prolog was invented in Europe (Marseilles, France and Cambridge, England). It is the European A.I. language of choice, and was selected by the Japanese as the basis of their Fifth Generation Project. This version of Prolog was created by the inventors of the language, and includes the latest developments.

Knowledge Engineers Wanted

The demand for skilled knowledge engineers is sky high. Until now, it was impossible to get the necessary experience without talking your boss into buying over \$100,000 worth of equipment and software or mortgaging your house. Now, with **ExperLisp+** and **ExperOPSS+**, you can start gaining experience immediately.

Just in case nobody ever told you before, Macintosh is a trademark of Apple Computer Inc., **ExperLisp**, **ExperOPSS**, **ExperFacts**, **ExperLogo** are trademarks of ExperTelligence, Inc., Prolog II is a trademark of PrologIA.

© ExperTelligence Inc., 1986.

*Win a Free trip to Paris Offered by Air France !

To participate in our drawing, just send us your business card with this coupon, and tell us what Expert System you could develop with **ExperOPSS** and/or **ExperLisp**, or what Expert System(s) you would like to see for your profession. Offer ends 8/31/86.

For more information, contact:

ExperTelligence, Inc.
Department P
559 San Ysidro Road
Santa Barbara, CA 93108
(805) 969-7871

CIRCLE 278 ON READER SERVICE CARD

The Macintosh Section

Last month we saw that a complete 68000 instruction is made up of an instruction mnemonic and up to two operands that tell the 68000 where to find data to work with and where to store results. To review, the general form of a two-operand instruction, such as MOVE, is:

MOVE source_operand,dest_operand

A location to be used by an instruction is called an effective address and can be a memory location or an internal register specifically referred to in the instruction, or can be a memory location calculated by the addition of as many as three different quantities. The availability of so many different ways to access data permits you to write efficient and powerful programs.

You tell the 68000 how to calculate an effective address by specifying an addressing mode for each operand an instruction uses.

You can use 12 fundamental addressing modes with the 68000. The assembler formats for these modes (as suggested by Motorola, the designer of the 68000) are summarized in figure 1, as are the effective-address calculations for each mode. Be aware, however, that not all instructions can use each addressing mode. To determine which are permitted, you'll have to consult the detailed description for the instructions in question in the Motorola reference manuals.

Let's now look at each of the addressing modes.

PROGRAMMING

BY GARY B. LITTLE

PART II

68000 ASSEMBLY-LANGUAGE PROGRAMMING

*The availability
of so many
different ways
to access
data permits
you to write
efficient and
powerful programs.*

A few 68000 instructions don't require you to specify all operands, because the "missing" operands are implicit to the instruction. The implicit operand usually involves the program counter, the stack pointer, or the status register.

For example, when you use the JMP (jump) instruction, the only operand you have to specify represents the target address of the jump. You don't have to indicate that this address is to transfer into the program counter: this requirement is implicit.

Immediate

An immediate operand is a numeric constant that forms part of the one to five words each 68000 instruction occupies. Its location within the instruction is the effective address.

The assembler format for the Immediate addressing mode is #number, where number represents an absolute number or a

symbolic label for a number. The # symbol preceding the number is very important; if you don't include it, the instruction will assemble as if the operand were an address, rather than a constant, so the program won't work properly. Examples of immediate operands are:

#45	;decimal 45
#\$2D	;hex 2D (45)
#mySize	;symbol

Notice that hexadecimal numbers are preceded by a \$ character.

Data Register Direct

When you use this addressing mode, the operand is simply one of

the eight data registers, D0–D7. To select this mode when you write a program, refer to the data register as Dn (n = 0–7). Here are some simple examples of how to use the Data Register Direct addressing mode:

```
MOVE #4,D0    ;4 -> D0.W
CLR.L D4      ;0 -> D4.L
```

When you use the Data Register Direct addressing mode, you can deal with operands that are three different sizes: byte, word, and long word. To indicate the size of the operand, you attach one of the following suffixes to the standard instruction mnemonic:

```
.B (byte)
.W (word)
.L (long word)
```

When you specify a suffix, the instruction uses only the first 8 (byte), 16 (word), or 32 bits (long word) of the data register. If you don't do so, your assembler will assume it's dealing with a word operation.

Address Register Direct

The operand here is one of the eight address registers, A0–A7. You refer to an address register by a name of this form to select the Direct addressing mode. (A7 is usually referred to as SP, for *stack pointer*.)

Here's an example of how to load the address with the label Record into the address register A0:

```
LEA Record,A0
```

Although you don't have to store addresses in an address register, you will often use them for that purpose so you can take advantage of the 68000's powerful Address Register Indirect addressing modes. You typically use these modes after first storing the base address of a data structure in an address register—you can't use the indirect modes with data registers.

Address Register Indirect

The operand here is one of the eight address registers, but the effective

address that instructions act on is the address stored in the register, not the register itself. To indicate this addressing mode, you enclose the name of the address register in parentheses. The assembler format for this addressing mode is (An).

Here are two examples:

```
MOVE.L    #4,(A3)
MOVE      D0,(A2)
```

You should be careful not to confuse this indirect mode with the Direct mode, in which data is read from or written to the register itself. Whenever you see the parentheses, think "contents of."

Address Register Indirect with Post-Increment

This addressing mode is quite similar to the Address Register Indirect mode, except that after the processor uses the effective address, it increments the number in the address register by 1 (for a byte operation), 2 (for a word operation), or 4 (for a long

NAME OF ADDRESSING MODE	EFFECTIVE ADDRESS CALCULATION	ASSEMBLER SYNTAX
Data Register Direct	EA = Dn	Dn
Address Register Direct	EA = An	An
Register Indirect	EA = (An)	(An)
Register Indirect with Post-Increment	EA = (An), An = An+N	(An)+
Register Indirect with Pre-Decrement	An = An-N, EA = (An)	-(An)
Register Indirect with Displacement	EA = (An)+d16	d16(An)
Register Indirect with Index	EA = (An)+(Rn)+d8	d8(An,Rn)
Absolute, short	EA = (next word)	xxxx
Absolute, long	EA = (next long word)	xxxxxxxx
PC Relative with Displacement	EA = (PC)+d16	d16(PC)
PC Relative with Index	EA = (PC)+(Rn)+d8	d8(PC,Rn)
Immediate, standard	Data in next word/words	#xxxx
Immediate, quick	Data in operation word	#xx
Implicit	EA = SR, SP, PC, USP	

ABBREVIATIONS

EA = effective address	SP = stack pointer (same as A7)
Dn = data register (n = 0–8)	USP = user stack pointer
An = address register (n = 0–8)	N = 1 for bytes, 2 for words, 4 for long words
d16 = 16-bit signed displacement	() = "contents of"
d8 = 8-bit signed displacement	
Rn = address or data register used as index (n = 0–8)	xx = byte-length number
PC = program counter register	xxxx = word-length number
SR = status register	xxxxxxxx = long-word-length number

Figure 1: 68000 addressing modes

word operation). You designate this addressing mode by placing parentheses around the name of the address register, followed by a plus sign to indicate the post-increment operation: $(A_n)+$.

The Post-Increment addressing mode is particularly useful when you're moving ranges of memory from one place to another, because you don't have to follow each move with extra instructions to increment the base pointers for the two blocks. For example, consider the instruction

```
MOVE      (A0)+,(A1)+
```

If you execute this instruction ten times in a row, the 68000 will move the ten words beginning at the initial address stored in A0 to a block beginning at the initial address stored in A1. After each word moves, the address registers increment by two (it's a word operation), so that you're automatically ready to move the next word.

Post-increment addressing is also handy for removing ("popping") data that you pass onto the 68000's hardware stack, as we will see at the end of this article.

Address Register Indirect with Pre-Decrement

This addressing mode is primarily for adding items to the hardware stack. You designate it by placing a minus sign before the name of an address register enclosed in parentheses: $-(A_n)$.

The 68000 calculates the effective address by first decrementing the contents of the address register by 1 (for a byte operation), by 2 (for a word operation), or by 4 (for a long-word operation). The address it acts on is the new address in the register.

Address Register Indirect with Displacement

The 68000 calculates the effective address here by adding a 16-bit word with a plus or minus sign (a "sign-extended" word) to the address stored in an address register. The assembler format for this addressing mode is $d16(A_n)$, where $d16$ represents a number from -32768 to 32767 , or a symbolic label for such a number. If you use a number or label, do not precede it with #, as you would do if you were using the Immediate addressing mode.

This addressing mode is typically for accessing a specific item in a data

structure whose base address is stored in the address register. For example, if there's a data structure beginning at location Addresses in your program, and you want to read the third word in the structure, you could use the instructions

```
LEA      Addresses,A0
MOVE     4(A0),D0
```

As we'll see next month, you'll be using this addressing mode quite often on the Macintosh, because any variables you define within the program must always be referenced as displacements from the address stored in the A5 register. So, for example, if you call your variable MyRecord, a MyRecord(A5) operand gives its base address, and the address of the third word in the data structure is MyRecord+4(A5).

Address Register Indirect with Index

The 68000 calculates the effective address for this addressing mode by adding together the number stored in an address register, an index stored in another address register or a data register (sign-extended word or long word), and an 8-bit, sign-extended, displacement byte. This mode is the

Still Searching?

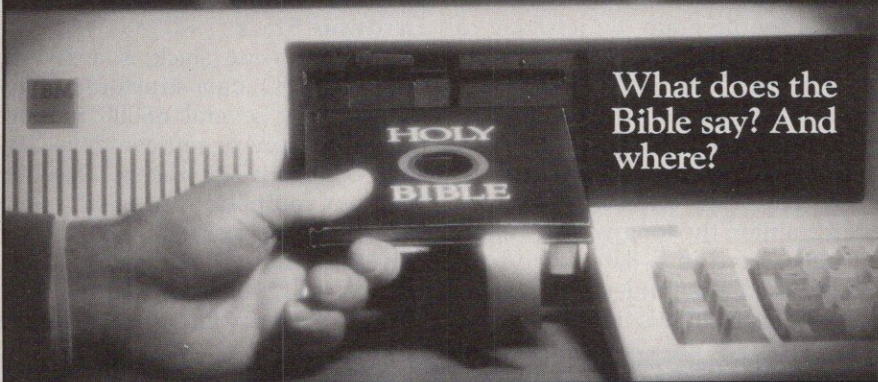

What does the Bible say? And where?

We offer an integrated family of software products that allow you to search the Bible as never before.

With "THE WORD Processor" software (which includes the complete text of the KJV or NIV Bible) you can create indexes on key words, phrases, even concepts, as well as search, display or print, for just \$199.95. Greek and Hebrew Transliterator products which include Strong's Concordance are also available. Or choose from a host of other exciting Biblical software products available in varying price ranges.

So if you're still searching, give us a call. We're anxious to show you how your PC can help you access your Bible as never before.

Include \$3.00 for postage and handling. For Apple, IBM PC, Commodore 64, TRS80, Kaypro, CPM 2.2, MS-DOS.

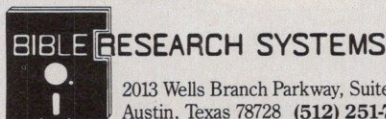

BIBLE RESEARCH SYSTEMS
2013 Wells Branch Parkway, Suite 304
Austin, Texas 78728 (512) 251-7541

CIRCLE 158 ON READER SERVICE CARD

PROTECT YOUR APPLE...



IN A CABBAGE!

Now, take your computer with you anywhere you go... completely protected... in a custom-designed case by Cabbage. Any brand... including any peripheral hardware. We design... just for you.

Unsurpassed quality and craftsmanship... that's a Cabbage!

Best Protection for... Anything!

- Audio-Visual Equipment
- Computers
- Medical Equipment
- Electronic/Optical Equipment
- Musical Instruments
- Scientific Instruments

CABBAGE CASES

2458 Wood Avenue
Columbus, Ohio 43221
(614) 486-2495

"Nothing's Tougher... Than a Cabbage"

CIRCLE 213 ON READER SERVICE CARD

most complex of the 68000's addressing modes, but, as you can see from figure 2, it is not too difficult to visualize what is happening.

The assembler format for this mode is $d8(An,Rn)$, where Rn represents the data or address register being used as the index register and $d8$ represents an eight-bit number or a symbolic label for the number. In order to indicate whether the index register is a word or a long word, you add a $.W$ or $.L$ suffix to the Rn name in the instruction; examples are $D3.L$, $A0.W$, and $D2.W$. If you don't specify a suffix, the assembler assumes a word index. Note that since the displacement byte is only eight bits long, the displacement range is from -128 to $+127$. (The base point is the word following the first word of the instruction.)

This indexed addressing mode is useful when you're working with a group of fixed-length records. To access any record in the group, you first store the address of the first record (record 0) in an address register, then multiply the record number you want by the number of bytes in the record, and store the result in the index register. When you access the record, you can use the displacement byte to step to the field in the record in which you are interested.

Absolute

The effective address for the Absolute addressing mode is the specific address that is stored in the instruction bytes. The assembler format is $abcdef$ —i.e., a six-digit hexadecimal number (or a symbolic label).

Note that if you use a label that refers to a position within your application program, Macintosh assemblers use the Program Counter with Displacement addressing mode instead.

Program Counter with Displacement

The effective address is the sum of

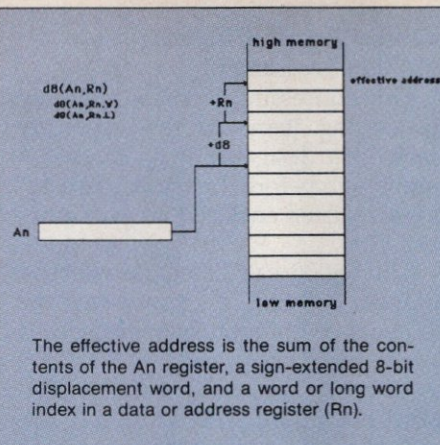

Figure 2: Address Register Indirect with Index addressing mode

the address in the program-counter register and a sign-extended, 16-bit displacement word.

The assembler format is $label(PC)$ or $label$, where $label$ represents the symbolic label for a position within the program. The assembler automatically determines what the displacement between the program counter and the labeled position will be and puts it into the executable object code for the program. You should never have to calculate it yourself.

Program Counter with Displacement is a very important addressing mode on the Macintosh because all the programs you write must be relocatable (that is, able to run at any position in memory)—no part of the program may refer to an absolute location if that location is within the body of the program. By referring to addresses in a relative way, the operating system can load and run the program anywhere it wants.

Program Counter with Index

The effective address for this mode is the sum of the address in the program counter, the long word or sign-extended word in a data or address register used as an index, and a sign-extended eight-bit displacement byte.

The assembler format is $label(PC,Rn)$, where Rn represents the data or address register being used as the index and $label$ represents the location of another instruction in the program. The assembler converts this location into an eight-bit offset from the value of the program counter.

As with the Address Register Indirect with Index Mode, the index register can be a word or a long word. Use the $.W$ or $.L$ suffix to identify its size.

The Program Counter with Index Addressing Mode requires one extension word. The first byte contains information relating to the index register and its size. The second byte contains the eight-bit displacement. Note that since the displacement byte is only eight bits long, the displacement range is from -128 to $+127$. (The base point is the word following the operation word.) Thus, the data structure you're indexing into must be quite close to the instruction.

The Program Counter with Index addressing mode is quite similar to the Address Register Indirect with Index that we looked at earlier. In fact, it's possible to write code to access records in a data structure that uses either addressing mode. The advantage of using the Program Counter with Index mode is that you don't "waste" an address register for storage of the base address. The disadvantage is that the base address must be within the range the eight-bit displacement byte provides.

Hardware Stack

The hardware stack is a last-in, first-out (LIFO) data structure implicitly used by several 68000 instructions that store or retrieve data. The LIFO characteristic means that the last item you place (or "push") onto the stack is the first item removed (or "pulled") from it. Figure 3 shows what a stack looks like and where data is pushed onto it and pulled

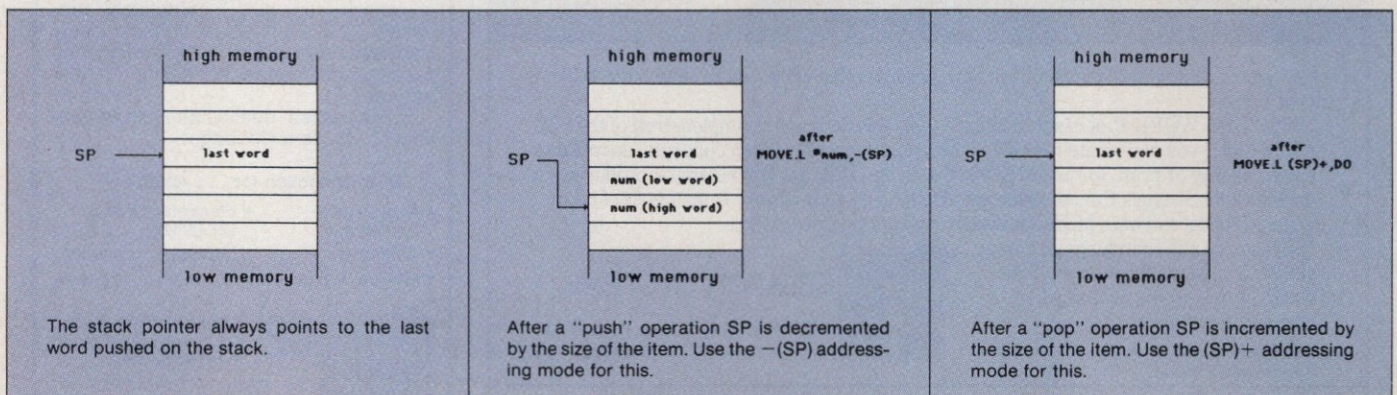

Figure 3: The 68000 stack and stack pointer. The address at the top of the stack is stored in the current stack-pointer register, SP.

from it. The address of the top of the stack (the address of the last item pushed onto the stack) is stored in the current stack-pointer register, SP (the A7 register). The Macintosh operating system initializes its value when you start up.

When you push data onto the stack, the 68000 first decrements the stack pointer by the size of the data and then stores the data at the address stored in the stack pointer. Note that since the processor decrements the stack pointer when you place something onto the stack, the stack grows downward in memory.

The most common instructions that implicitly push data onto the hardware stack are JSR and BSR, which push long-word addresses (of the following instruction) before calling a subroutine.

When you pop data from the stack, the stack pointer increments by the size of the data. The most common instruction that implicitly pops data from the hardware stack is RTS—it pops addresses a JSR or BSR instruction has pushed there. It pops into the program counter, so that processing continues with the instruction following the original JSR or BSR.

You can explicitly use the stack for temporary data storage by using the SP Indirect with Pre-Decrement addressing mode, -(SP), to place data onto the stack. When you want to remove data, you can use the corresponding post-increment addressing mode, (SP)+. We're going to see next month that most of the internal ROM subroutines used on the Macintosh to perform standard operations are accessed by passing parameters on the stack using the pre-decrement addressing mode; function results are retrieved from the stack using the Post-Increment addressing mode.

The hardware stack can be positioned anywhere in memory, but you usually place it near the top of the available RAM space to leave as large a space as possible for program use.

Well, that's it for this month. Next month we'll see how to generate a simple 68000 program with the assembler tools in the Macintosh 68000 Development System (MDS). +

Look for Gary Little's next book, 68000 Programming on the Macintosh, this fall. Gary is also the author of Point-to-Point, a communications program for the Apple II published by Pinpoint Publishing.

COVER UP



Macintosh Plus
Cover Ups Available Now

COVER UPS: Contemporary dust covers made of first quality 400 denier rip stop nylon. COVER UPS are water resistant and anti-static. They will not tear, crack or create lint problems as do many vinyl and cloth covers. All seams and hems are double stitched for that finished look. COVER UPS will outlast the useful life of your computer, insuring years of worry free protection. We specialize in dust covers for Apple products and update our product line frequently. Don't hesitate to protect your new Apple! Individual covers available for most components, plus specially designed one piece covers for larger sets, such as the Apple II's, IBM PC's, and COMPAQ's. Available in six attractive colors: Bone (similar to the Mac), Blue, Brown, Rust, Smoke (gun metal grey), and Tan.

Macintosh/Mac Plus Sets (Specify)

	Prices
#M1B Macintosh, Keyboard, and Mouse	\$19.95
#M1 Macintosh, Keyboard, Imagerwriter ¹ , and Mouse	\$27.95
#M2 Macintosh, Keyboard, Imagerwriter ¹ , External Drive (400/800K), and Mouse	\$29.95
#M5 Macintosh, Keyboard, Large Imagerwriter, and Mouse	\$29.95

Apple IIc Sets

#C1 Apple IIc CPU, Monitor ² , and Mouse (Separate covers)	\$18.95
#C2 Apple IIc CPU, Monitor ² , External Disk Drive, and Mouse	\$24.95
#C3 Apple IIc CPU, Monitor ² , Imagerwriter ¹ , External Disk Drive, and Mouse	\$29.95
#C4 Apple IIc CPU, Monitor ² , Scribe, External Disk Drive, and Mouse	\$29.95

Apple IIe Sets

#E1 Monitor ³ atop IIe CPU (One piece cover. Components available)	\$23.95
#E11 E1 with Imagerwriter ¹ (Two covers)	\$31.95
#E2 Monitor ³ atop Profile DuoDisk atop IIe CPU, (One piece cover. Components available)	\$26.95
#E21 E2 with Imagerwriter ¹ (Two covers)	\$34.95

- 1 - Substitute Imagerwriter II for Imagerwriter. Any set add \$1.00.
Substitute Laserwriter for Imagerwriter. Any set add \$5.00.
- 2 - Substitute IIc Color Monitor for Green Monitor. Any IIc set add \$1.00.
- 3 - Substitute IIe Color Monitor for Monitor II. Any IIe set add \$1.00.

Other COVER UP Sets Available Including IBM and Compaq.

STAND-UPS: Universal printer stands designed to raise your printer for easy viewing and provide ample space below for paper storage. Our STAND-UPS are metal with a textured powder coat finish (same as your printer), and include molded rubber booties to protect your printer and desk top. Available in black or computer white. STAND-UPS are truly the first reasonably priced printer stands. Retail Value \$23.95 Direct Order \$18.95

SLIP-UPS: Our own special mouse pad. Help keep your mouse clean and rolling easy. Two sizes and four colors to choose from: Blue, Brown, Bone, and Red.

LII Slip-Up — 6" x 8" Pad (Complete screen coverage and more - Pictured above)	Only \$ 4.95
Big Slip-Up — 8" x 9½" Pad (Room to spare)	Only \$ 7.95

Imagerwriter Ribbons (First Quality. Satisfaction Guaranteed)

Black:	\$4.50/ribbon	Box of six Only \$21.95/\$3.66 ea.
Colored: (Mix or match)	\$6.00/ribbon	Box of six Only \$26.95/\$4.50 ea.

Available in six colors: Red, Blue, Green, Brown, Yellow, and Purple.

Scribe Ribbons

Black:	\$6.00/ribbon	Box of six Only \$26.95/\$4.50 ea.
--------	---------------	------------------------------------



► **PAK-UPS:** Now you can take it with you — your diskettes that is. Designed to conveniently hold 2, 4, 6, or 8 diskettes (3½"). (5¼" PAK-UPS available soon.) PAK-UPS are a lightweight convenience carrier for your diskettes that will easily fit in your briefcase or vest pocket. Velcro closure holds your diskettes safe and secure. Available in eight colors: Black, Brown, Blue, Bone, Green, Red, Smoke, and Tan.

Retail Value \$11.95 Direct Order \$9.95 or 2/\$16.95

ORDERING: Phone or mail order. We accept Visa & M/C.
SHIPPING: Continental U.S. UPS Ground \$3.00, 2nd Day Air \$4.00.
SCHOOLS: Purchase Orders Accepted.



SPECIAL: FREE SLIP-UP with the purchase of any COVER-UP set.
For a limited time only when you purchase direct.



Computer Cover Co.

P.O. Box 3080, Laguna Hills, CA 92654
CA (714) 380-0085 - Others (800) 235-5330

Macintosh/Mac Plus, Apple IIc, Apple IIe, Mac XL are all registered trademarks of Apple Computer.

pegboard

ACCOUNTING SYSTEMS

SOFTWARE BY RUSEL DEMARIA

"Pegboard" accounting systems have been popular with small businesses for many years. They are also called one-write systems because they are designed to post information to several places at once. For instance, when you write a check, the carbon paper transfers the information to a

Payable modules. Remarkably, the entire program comes on one disk. The program requires either a second floppy-disk drive or a hard disk for data, depending on the amount of information involved. You can use Plains & Simple to run one or more companies.

Plains & Simple is extensively icon-oriented, a wonderful adapta-

manual includes an excellent tutorial that uses the sample information that comes on the disk.

Visually, Plains & Simple is just like a paper ledger system (see figure 2). You post all transactions on a grid that looks like a piece of paper. You can add or remove accounts from the display at any time. Although you can display your entire chart of accounts, you will probably limit the display to the accounts you deal with most frequently. You can scroll quickly to accounts that are off the screen by using the Tab key or the horizontal scroll bar.

Plains & Simple comes with 27 sample charts of accounts, ranging from service stations to medical offices (with real-estate agencies, restaurants, general retail outlets, and others in between). The 27 charts have enough variety to assure that most small businesses will find one that suits their needs with little or no modification. You can also choose which accounts will appear on summary reports.

Plains & Simple is a versatile system. For instance, you can enter transactions directly from the appropriate monthly journal or from one of the customer or vendor cards. In either case, the transaction posts to both places. You can also apply payments selectively to invoices. Because the program is all on one disk, all in-

Plains & Simple from Great Plains Software and MacOneWrite from Sierra On-Line bring one-write accounting to the Macintosh.

cash-disbursements ledger and also to a ledger card for the vendor or recipient of the check. The same principles apply to the recording of receivables.

Now computer programmers are discovering how naturally the pegboard system fits into computerized accounting. Two fine examples for the Macintosh are Plains & Simple from Great Plains and MacOneWrite from Sierra On-Line.

Plains & Simple

Plains & Simple is a fully integrated one-write accounting program, that includes General Ledger, Accounts Receivable, and Accounts

tion of the Macintosh operating environment. You begin work from a central screen divided into three parts: G/L, A/R, and A/P (see figure 1). By selecting the appropriate icon, you can open up Chart of Accounts, General Ledger, General Journal, Sales/Cash Receipts or Purchases-/Cash Disbursements Journals, Customer or Vendor Cards, Company Information, and Reports.

Although the Plains & Simple manual does a good job of guiding you in the use of the program, it stresses often that you should leave the initial setup to someone well versed in accounting principles. The

PC NETWORK THE #1 SOURCE FOR ALL YOU

MEMBERS PAY WHOLESALE + 8% OR LESS AND GET 14-30 DAY SOFTWARE RENTALS



OUR ROSTER INCLUDES SOME OF THE MOST IMPORTANT NAMES IN INDUSTRY:

AT&T	General Mills
Barclays Bank	General Electric
Bell & Howell	General Motors
Citibank	Hewlett Packard
Columbia University	IBM
Data General	ITT
Exxon	Kodak
Frontier Airlines	Yale University

Plus 150,000 THOUSAND satisfied consulting firms, small businesses, governments, schools and value minded individuals.

**CALL TOLL FREE
800-621-SAVE**

(Orders—Membership and Advice!)
In Illinois Call (312) 280-0002
Your Membership Validation Number **M576**

You can validate your membership number and, if you wish, place your first money-saving order over the phone by using your VISA, MASTERCARD or AMERICAN EXPRESS. Our knowledgeable sales consultants are on duty Mon.-Fri. 8:00 AM to 7:00 PM, Sat. 9:00 AM to 5:00 PM CST.



PERSONAL COMPUTER NETWORK
320 West Ohio Street
Chicago, Illinois 60610



PC NETWORK MEMBERSHIP APPLICATION YES!

Please enroll me as a member in the PC NETWORK™ and send my catalog featuring thousands of computer products, all at just 8% above DEALER WHOLESALE PRICES. I will also receive "THE PRINTOUT", a special quarterly update on merchandise at prices BELOW even those in my wholesale catalog and all the other exclusive, money-saving services available to Members. I am under no obligation to buy anything. My complete satisfaction is guaranteed.

Please (✓) all boxes that apply: **576**

Basic Membership 1 Year 2 Year
 \$8 \$15
 With 14 Days Rental
 Business Software Rental Library \$25 add'l. per year
 Games Software Rental Library \$10 add'l. per year

Special V.I.P Membership 1 Year 2 Year
 \$15 \$25
 With 30 Days Rental
 BOTH Business and Game
 Software Rental Libraries \$30 add'l. per year

Bill My Credit Card: VISA MasterCard American Express
 Account Number:

Exp. Date _____
 mon. yr.

Check or Money Order Enclosed for \$ _____

Name _____

Address _____ Apt. No. _____

City _____ State _____ Zip _____

Telephone () _____

My Computer(s) is: IBM PC IBM XT IBM AT
 Apple II Macintosh Other _____

Signature _____
 (Signature required to validate membership)
 Copyright© 1986, PC NETWORK, INC.

Macintosh

512K Enhanced/Mac Plus
400/800 Disk Drive, Keyboard
Mouse, Software

PRICES TOO LOW TO PRINT!



THE™ PC+
640K RAM, IBM™ Compatible,
360K Disk Drive, Turbo Speed,
"AT" Style Keyboard

\$469.00*



15" WIDE

IMAGEWRITER
\$485.00*

w/Mac Kit

MICROSOFT

EXCEL
\$197.50*

(At Unheard of Prices!!!)

Multiplan, File or Word 97.50*
 BASIC 75.00*
 Chart 62.00*

DISKETTES

Guaranteed for Life!

Brand name diskettes available in boxes of 10 or in bulk packs of 50

5¼" SS/DD	3½" SS/DD	3½" DS/DD
Box 10	Box 10	Box of 10
\$7.95*	\$14.50*	\$19.95*
ea. .47*	Free Flip 'n' File Case	Free Flip 'n' File Case

INFOCOM



\$19.75* \$19.75* \$21.75* \$21.75*

Available for Apple II & Mac

APPLE

MAC TERMINAL
Mac's Most Popular Communication Package

\$77.00*

APPLEWORKS

Most Popular Integrated Package for Apple IIe/IIc Complete Word Proc./Spreadsheet/Data Base

\$160.00*



Apple 800KB Macintosh Drive **PC Network External IIc Drive**

\$349.95* **\$95.00***

Broderbund

Print Shop **Bank Street Writer**

\$24.75* **\$35.25***

HAYDEN

Sargon III
\$24.75*

GATO

Apple II
Mac
\$17.75*
\$22.00*

*PC Network Members pay just 8% above the wholesale price, plus shipping. All prices reflect a 3% cash discount. Wholesale prices fluctuate rapidly—all prices in this issue have been prepared 60 days in advance. Please call for latest prices. Minimum shipping \$2.50 per order. International orders call for shipping & handling charges. Money Orders, personal and company checks please allow 10 working days to clear.

APPLE AND MACINTOSH NEEDS!

OVER 30,000 PRODUCTS AT EVERYDAY LOW, LOW PRICES!

EDUCATIONAL SOFTWARE

(Please add \$1 shipping and handling for each title ordered.)

Wholesale	Wholesale
Bluechip Baron, Millionaire or Tycoon \$19.75*	▶ Mark of the Unicorn Mouse Stampede 17.25*
Broderbund Lode Runner, Choplifter 17.00*	Penguin Graphics Magician—Mac Only 28.97*
Broderbund Print Shop 24.75*	Penguin Transylvania—Mac Version Only 20.00*
Davidson & Associates Speed Reader II 31.00*	Screenplay Professional Blackjack 39.88*
Davidson & Associates Math Blaster 22.00*	Sierra On-Line Frogger—Mac Too! 19.50*
Davidson & Associates Word Attack! 21.50*	Sierra On-Line Crossfire 18.00*
Hayden DaVinci—House/Interiors or Landscapes—Mac Only 23.00*	Simon & Schuster Typing Tutor III—Mac Tool 28.25*
Hayden Sargon III 24.75*	Str-Tech Wizardry 17.25*
Hayden SAT Sampler Test 11.97*	Spectrum Holobyte GATO 17.75*
Infocom Deadline, Suspended, Seastalker 24.00*	▶ Spinnaker Alphabet Zoo, Face Maker, Story Machine, Hey Diddle Diddle, Rhymes & Riddles, 15.25*
Infocom Enchanter, Planet Fall, Cutthroats 19.75*	▶ Spinnaker Delta Drawing 20.75*
Infocom Zork II, Zork III 21.50*	Sublogic Flight Simulator II 27.25*
Infocom Zork I, Witness, Hitchhiker's Guide, 19.75*	Sublogic Night Mission Pinball 19.25*
Infocom Suspect, Infidel, Sorcery 21.75*	Virtual Combinatics Micro Cookbook 17.50*

BUSINESS SOFTWARE

(Please add \$2.50 shipping and handling for each title ordered.)

Wholesale	Wholesale
Apple Apple Works \$160.00*	Human Edge Management of Sales Edge 110.00*
Arrays Home Accountant 35.00*	▶ Living Videotext ThinkTank—512K Mac 585.00*
Arrays Home Accountant Expanded 42.00*	Microsoft Excel 197.50*
ATI How to Use Multiplan 42.00*	▶ Microsoft Multiplan (DOS or CPM) 97.50*
Borland SideKick for Mac 37.50*	▶ Microsoft For Macintosh: Word, File, Multiplan 97.50*
Borland International Turbo Pascal 30.00*	Microsoft Basic for Macintosh 75.00*
BPI GL, A/P, A/R, P/R, or INV Each Only 190.00*	Microsoft Chart for Macintosh 62.00*
Broderbund Bank Street Writer 35.25*	Monogram Dollars & Sense 55.00*
Broderbund Print Shop 24.75*	Monogram Dollars and Sense for Mac Only 63.00*
Central Point Copy II Plus 16.25*	Odesta Helix for Macintosh, Reg's 512K 200.00*
Dow Jones Software Market Analyzer 184.50*	Software Publishing PFS: File, PFS: Write 61.00*
Dow Jones Software Market Manager 103.50*	Software Publishing PFS: Graph 63.50*
Funk Software Sideways 26.50*	T/Maker Click Art for Macintosh Only 24.75*
HowardSoft Real Estate Analyzer III 163.00*	United Software Industries Ascii Express Pro 64.75*
Human Edge Mind Prober 22.00*	

HARDWARE

(Please add shipping and handling charges found in italics next to price.)

COMPLETE SYSTEMS	BOARDS AND BUFFERS
Apple Apple IIe, IIc CALL	AST Research Multi I/O-2 \$155.00* (2.50)
AT&T 6300 PC CPU 2 \$1,575.00* (34.02)	Microtek Dumping/GX 55.00* (2.50)
128K/2 Floppy/1 Serial/1 Parallel	Okidata ML 193P 132COL/160CPS 425.00* (2.50)
AT&T 7300 Unix PC 3,699.00* (79.90)	Orange Micro Grapppler + 66.00* (2.50)
10MB Hard Disk/1 Floppy/512K	Orange Micro Serial Grapppler 66.00* (2.50)
▶ COMPAQ DeskPro 1,940.00* (61.11)	PC Network Z80 Card 35.00* (2.50)
w/256K/1 Floppy/10MB Hard Disk	Quadram Multicore 1 Parallel, 140.00* (2.50)
COMPAQ Hard Disk Portable 256K CALL	1 Serial, Clock Expandable to 256K
▶ IBM PC Base System 1,159.00* (25.00)	Quadram MP-8K Microfazer 110.00* (2.50)
with 256K 2DS/DD/FDC	Buffer (Expandable)
▶ IBM PC Professional Hard Disk 1,499.00* (32.38)	Quadram APIC/G Graphics Interface 62.00* (2.50)
256K/DS/DD/FDC/20MB Hard Disk	Quadram eRAM-80COL w/64K 88.00* (2.50)
IBM PC AT Base System 2,795.00* (60.37)	Street Electronics ECHO II 85.00* (2.50)
1.2MB Floppy/256K	Speech Synthesizer
	Titan Technologies Accelerator IIe 207.35* (2.50)
	Video 7 Apple IIc RGB Adapter 70.00* (2.50)

DISK DRIVES & CONTROLLERS

Apple All MODELS CALL	
Apple Macintosh Add On Drive 349.95* (7.50)	
Apple UniDisk 3.5" w/accessory kit 319.00* (6.89)	
Corvus 6MB Hard Disk 675.00* (14.58)	
Haba 800MB DS/Mac Drive 215.00* (4.64)	
IOmega 5MB MacnouiII 1,250.00* (27.00)	
IOmega Dual 10MB MacnouiII 2,150.00* (46.44)	
Micro-Sci A2 143MB Drive 150.00* (5.00)	
Micro-Sci H/H Drive for II+ /IIe 145.00* (5.00)	
Micro-Sci H/H Floppy Controller 55.00* (2.50)	
Paradise 10MB Hard Disk 525.00* (11.34)	
Subsystem for Macintosh	
Paradise 20MB Hard Disk 745.00* (16.09)	
Subsystem for Macintosh	
PC Network Apple IIc External Drive 95.00* (5.00)	
▶ PC Network Apple IIc Disk Drive 85.00* (1.84)	
Tecmar 10MB Hard Disk for Mac 999.00* (21.58)	

MODEMS

Anchor Lightning 2400 309.00* (2.50)	
Anchor Signalman Express \$205.00* (5.00)	
Hayes Micromodem IIe/Smartcom 125.00* (2.50)	
Hayes Smartmodem 300 125.00* (2.50)	
Hayes Smartmodem 1200 340.00* (5.00)	
Hayes Smartmodem 2400 525.00* (5.00)	
MicroCom Mac Modem 1200 348.00* (2.50)	
Novation Apple Cat II 174.45* (2.50)	
Prometheus ProModem 1200 247.00* (6.00)	
with Mac Pac 253.00* (6.00)	
▶ Prentice Pop Com w/MacPac 215.00* (2.50)	
1200 Baud Modem, Cable Straight	
U.S. Robotics Courier 2400BPS 345.00* (5.00)	
Zoom Modem IIe 95.00* (2.05)	
THE™ MONITORS ARE 100% HAYES COMPATIBLE	
THE™ 1200 COM External 129.00* (5.00)	
THE™ 2400 COM External 277.00* (5.00)	

MONITORS

Amdex Video 300G Composite \$110.00* (3.00)	
Amdex Video 300A Composite 120.00* (3.00)	
Amdex Color 300 215.00* (3.00)	
Amdex Color 600 RGB 365.00* (3.00)	
Apple NEW! Super Color IIe 255.00* (2.55)	
Apple Color Monitor IIc 259.00* (2.55)	
Apple Color Monitor IIc 365.00* (3.00)	
Princeton HX-9" RGB Monitor 387.50* (8.36)	
Princeton HX-12 RGB Monitor 382.00* (3.00)	
Taxan 620-U High Res Color 81.00* (2.50)	
Zenith ZVM 1230A NEW! 12" High Res Green/Non Glare	

PC NETWORK



NEW! PC NETWORK ONLINE

A 24 Hour Bulletin Board and Information Service Center

- **FREE SOFTWARE:** Over 20,000 downloadable shareware titles.
- **NEWS FLASHES AND REVIEWS:** Tie into the worlds largest computer News Network .Get all the latest on Apple,™ IBM,™ Mac, Unix and related subjects.
- **PLACE ORDERS, LEAVE MESSAGES FOR TECHNICAL SUPPORT—DAY OR NIGHT.**
- **LATEST PRICING:** and Special Sales on PC Network Products.

PC Network improves on the benefits its members continue to enjoy...

- **WHOLESALE + 8% PRICING.**
- **10 DAY RETURN ON HARDWARE**
- **600 PAGE NETWORK CATALOG**
- **QUARTERLY NEWSLETTER**
- **14-30 DAY SOFTWARE RENTAL**
- **FREE TECHNICAL SUPPORT**

30 Day Money Back Guarantee on Membership

TOLL FREE (800) 621-SAVE

In Illinois (312) 280-0002 Validation Code M576

Customer Service and Order Status (312) 280-1567

CIRCLE 315 ON READER SERVICE CARD

Mac Tool indicates the Mac version is available at the same price.

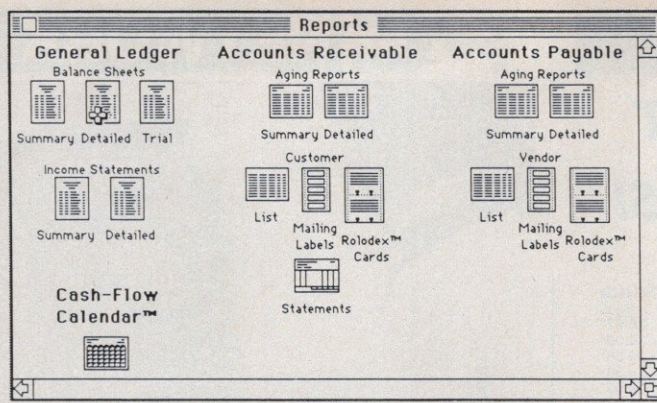

Figure 1: Plains & Simple's Reports menu screen

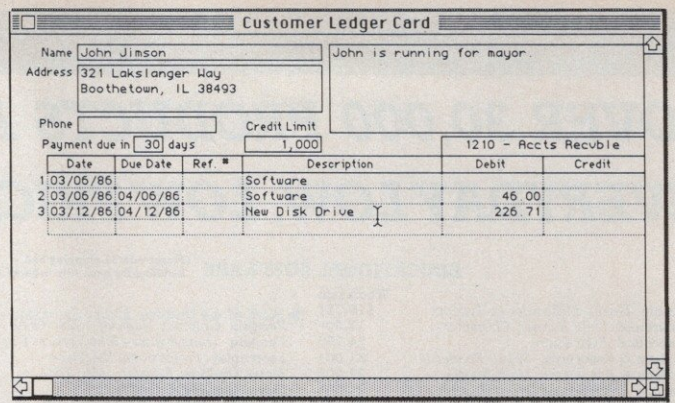

Figure 2: A customer ledger card from Plains & Simple

formation integrates automatically, and reports are up to date.

You can also add new customer or vendor cards at any time (even during transactions), or you can use a special miscellaneous classification for a one-time customer or vendor. When you select customers or vendors, you can select from Active, Due, Updated, all cards, or one individual card (see figure 3). Once you have made the selection, you can page from one card to another at will. You can set credit limits and terms on the cards. If you enter a transaction that exceeds a credit limit, the program alerts you.

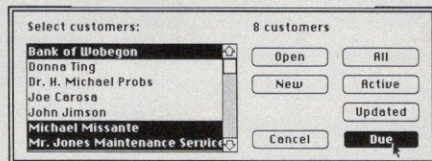

Figure 3: Choosing a customer ledger card with Plains & Simple. Note the choices and the highlighted entries under Due.

Numerous effort-saving features make Plains & Simple a joy to use. For instance, the first time you enter a date in a particular journal, you might enter the month and day (the program adds slashes for you). After thus establishing the month, you need only type the day. You can add a transaction for the wrong month, but the program will warn you before proceeding.

Typing part of a customer or vendor name is sufficient; the program displays the appropriate list, highlighting the closest match. The Auto Enter feature lets you balance any transaction automatically—Plains & Simple doesn't allow unbalanced transactions.

MacOneWrite

Sierra On-Line first introduced the Cash Disbursements module of MacOneWrite in June 1985. Since then

the company has added an Accounts Receivable module and a General Ledger. A Payroll module is still under development. MacOneWrite carries the pegboard metaphor about as far as it can be carried on a computer—down to the pegs themselves and the holes in the ledger paper (see figure 4). If you are already familiar with pegboard systems, you should feel right at home.

The three existing modules of MacOneWrite come on three separate disks; the system works well with any configuration, from a single disk drive to a hard disk. Although each module is independent and Accounts Receivable can integrate with Cash Disbursements, the best way to use MacOneWrite is with all three modules. You use the General Ledger to enter transactions not applicable to the other modules, to integrate data, and to produce most final reports.

Each module has its own accounts file. The C/D and A/R modules can share the same accounts file (on a hard disk or external disk drive), but the G/L accounts file is more extensive and also includes budgets and a user-definable category for groupings on balance sheets and income statements. This ability to group accounts allows you to control the output of

your reports and group all accounts appropriately. The C/D module can produce limited reports, but you cannot control groupings or display budget information with it.

Each module comes with a clear, informative manual and some sample files. The G/L manual even includes some basic accounting information that might be handy for novices.

You can call up your chart of accounts any time. Normally you fill in accounts by account number, but if you can't remember the number, you can call up the chart, highlight the desired account, and insert it automatically into the current journal.

Even better news is that you can set default accounts for various kinds of transactions in A/R journals. For instance, for invoices you might always disburse the transactions to your Sales and your Tax Liability accounts. For recording payments, you might use the main Cash in Bank account and, perhaps, Discounts Allowed. Thus you avoid having to reenter account numbers. Unfortunately, the C/D module does not include the default-account feature.

In the A/R and C/D journals, you select from a pull-down menu the kind of transaction (invoice, payment, credit memo, and the like) that you

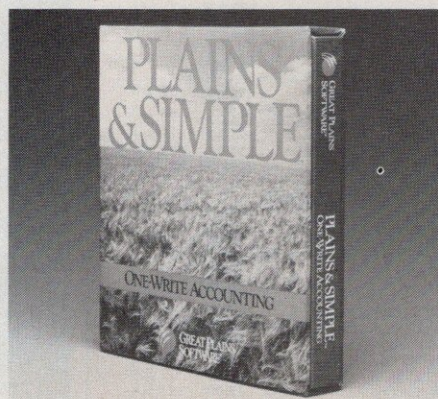

Plains & Simple from Great Plains Software

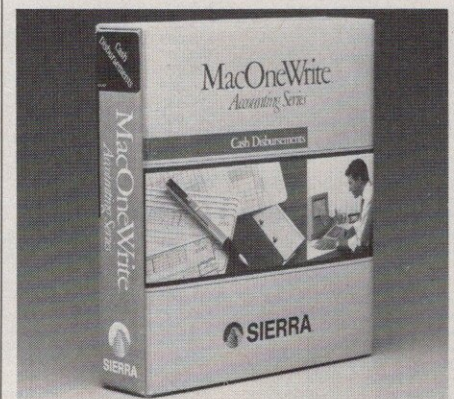

MacOneWrite from Sierra On-Line

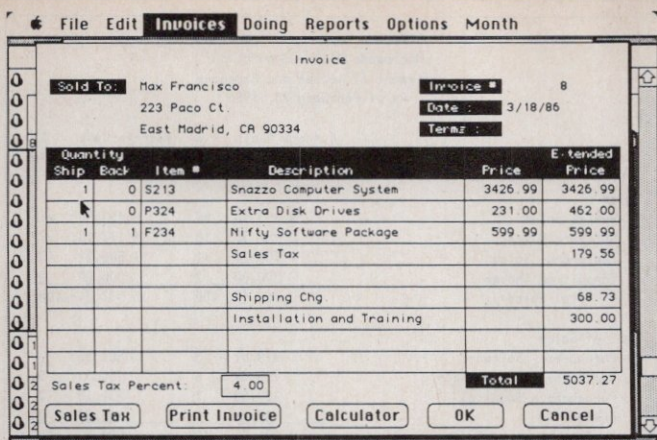

Figure 4: A detailed invoice screen from MacOneWrite

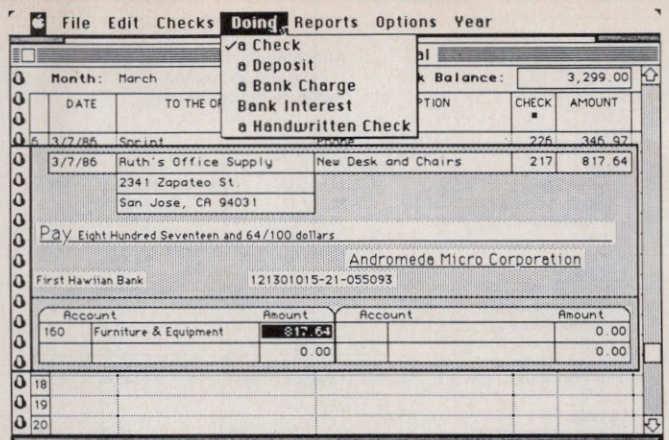

Figure 5: A cash-disbursements transaction with MacOneWrite

want. This selection stays in effect until you change it. Fortunately, you can begin an invoice, for instance; find that you meant to enter a payment; and change the choice without losing the information you've already entered (assuming you haven't posted the transaction yet).

Most transactions automatically use the system date or the most recently used date, and the program warns you when you try to enter a transaction for the wrong month. As you split transactions, the program

always displays a running total and prevents you from entering unbalanced transactions. If you need to do some extra figuring, the Mac calculator is always available (as it is in Plains & Simple).

You can selectively link payments with invoices by using a special column on the customer card, into which you can place any one-letter code. Items with matching codes will be associated. Thus, to apply a payment selectively to a specific invoice, you label both the payment and the

invoice with the same code.

Although you can enter sales transactions without having a detailed invoice, the invoice screen is excellent (see figure 4). The invoice automatically displays totals accumulated from unit prices, calculates the sales tax (at the rate you determine), and produces the grand total. Also, you can mark back-ordered items and add any other charges or credits necessary (before or after calculating the tax). You can then print the invoice on a standard invoice form.

MINICAD™ offers two fully integrated CAD systems, 2D drafting & 3D surface modeling in ultra-high precision.

- Engineers appreciate Minicad's 9 decimal precision.
- The 2D/3D integration provides Designers and Artists with the flexibility to explore ideas.
- Architects can create perspective displays as well as detailed floorplans.

MiniCad™

Computer Aided Design
by
Diehl Graphsoft Inc.

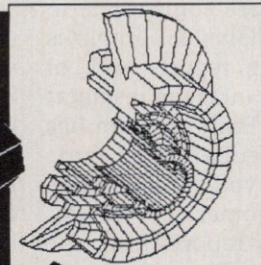

- 15 Layers with color & acetate attributes
- Multi-object data base
- Read-Write to text files
- 27 3D primitives
- Cut-Paste between 2D & 3D
- Direct links between 2D & 3D
- Wire frame, solid or shaded objects
- Transfer to clipboard or "PICT" file
- Rotation on any axis
- Unlimited Zoom
- User select perspective

- Advanced auto-dimensioning
- "Stable" data-base retains true dimensions
- Laserwriter or Imagewriter to 6 x 7 sheet grid
- Compatible with all Mac Plotter driver software
- Add virtually any scale to 16 pre-set values.

DIEHL GRAPHSOFT Inc.
3246-K Normandy Woods Dr.
Ellicott City, MD. 21043 301-461-9488

\$ 395.00

CIRCLE 331 ON READER SERVICE CARD

Peace of Mind

Echo's BRAND NEW protection scheme for the Mac is simply unbeatable.

Hard Disk Install with or without a KEY DISK is now a reality, with no danger of additional copies or user problems.

Used by the Best Names in Software!!

And Priced at 35¢ a copy!

SOFTWARE DUPLICATION

Nobody Does it Faster!!!

We promise AND DELIVER high quality & fast turn-around on every order! Full packaging available. Custom labels & sleeves ready in only two weeks!

**CALL : 800-533-4188
or 215-363-2400 in PA**



DATA SERVICES, INC.
Marsh Creek Corp Center
Lionville, Pennsylvania 19353

CIRCLE 123 ON READER SERVICE CARD

Andromeda Micro, Inc.

Detailed Income Statement
03/01/86 through 03/31/86

Income	Period		Year to Date	
	Amount	%	Amount	%
System Sales	\$9,845.00	71.4 %	\$9,845.00	58.8 %
Software Sales	2,690.97	19.5	4,720.34	28.2
Peripheral Sales	1,240.99	9.0	1,240.99	7.4
Other	8.72	0.1	944.08	5.6
Total Income	13,785.68	100.0	16,750.41	100.0
Cost of Sales				
Purchases - Software	771.00	5.6	1,283.55	7.7
Purchases - Peripherals	0.00	0.0	780.37	4.7
Purchases - Supplies	17.63	0.1	269.76	1.6
Freight In	13.51	0.1	73.33	0.4
Total Cost of Sales	802.14	5.8	2,407.01	14.4
Gross Profit (Loss)	12,983.54	94.2	14,343.40	85.6
Expenses				
Maintenance and Repairs	0.00	0.0	69.90	0.4
Postage	14.22	0.1	14.22	0.1
Telephone	346.97	2.5	346.97	2.1
Total Expenses	361.19	2.6	431.09	2.6
Net Operating Income (Loss)	12,622.35	91.6	13,912.31	83.1
Other Income				
Other Income	0.00	0.0	820.46	4.9
Total Other Income	0.00	0.0	820.46	4.9
Other Expenses	0.00	0.0	0.00	0.0
Net Other Income (Loss)	0.00	0.0	820.46	4.9
Net Income (Loss)	\$12,622.35	91.6 %	\$14,732.77	88.0 %

Andromeda Micro Corporation
Statement of Income and Expenses
As of February 28, 1986

	Current Month		Year-to-Date	
	Amount	% Sales	Amount	% Sales
Sales				
System Sales	9,453.90	69	9,453.90	61
Software Sales	2,492.36	18	4,117.10	27
Peripheral Sales	1,506.21	11	1,506.21	10
Consulting Income	300.00	2	300.00	2
Total Sales	13,752.47	100	15,377.21	100
Cost of Sales				
Purchases - Software	379.67	3	507.55	3
Purchases - Peripherals	780.37	6	780.37	5
Purchases - Supplies	129.58	1	252.13	2
Freight In	47.24	0	64.82	0
Total Cost of Sales	1,336.86	10	1,604.87	10
Gross Profit	12,415.61	90	13,772.34	90
General and Administrative				
Repairs & Maintenance	69.90	1	69.90	0
Total General & Admin.	69.90	1	69.90	0
Net Operating Income (Loss)	12,345.71	90	13,702.44	89
Other Income & Expenses				
Other Income	51.32	0	51.32	0
Net Income(Loss) before taxes	12,397.03	90	13,753.76	89

Figure 6: Comparing the visual appeal of a Plains & Simple report (left) and a MacOneWrite report (right)

You can also print checks with MacOneWrite and/or record manually written checks (see figure 5). The system remembers which checks it has not yet printed and prints them out when you are ready.

MacOneWrite automatically posts transactions to customer and vendor cards in the system. By calling up one of these cards, you can see at a glance all of that particular client's or vendor's activities. When entering names onto invoices or checks, you need type only part of the name, and the program fills in the rest. You can also print out a full A/R journal or an aged A/R journal at any time (even in the middle of a transaction) and add customer and/or vendor cards. When printing customer statements, you can add specified late charges on all balances over a certain age. You can also specify balance forward only or open items on the statement.

Finally, the MacOneWrite G/L lets you produce a SYLK file for use with Macintosh spreadsheet programs such as Excel or the Jazz spreadsheet module. Such a spreadsheet file contains all the proper labels, the entire chart of accounts, and all the data for up to two years.

Comparisons

Two significant differences distinguish Plains & Simple and MacOneWrite from each other. First, MacOneWrite does not have a full Accounts Payable module—it has Cash Disbursements, but no aging of accounts payable. In contrast, Plains

& Simple has a full A/P journal.

The second significant difference is that MacOneWrite comes on three separate disks, and Plains & Simple is all on one. On a hard disk, this distinction becomes fairly meaningless, but with floppies it makes a noticeable difference. On the other hand, you can use MacOneWrite with a single floppy-disk drive, and with Plains & Simple you cannot.

Both programs are comparable in speed, although Plains & Simple is faster at producing reports and, of course, has the advantage of instantaneous integration. Each program has features that expedite data entry. MacOneWrite lets you call up charts of accounts, customer or vendor cards, and various reports from the transactions screens; Plains & Simple does not. On the other hand Plains & Simple allows you to work directly on a customer or vendor card, and MacOneWrite doesn't.

The two programs also differ in their reporting setup. Plains & Simple displays all reports on the screen first and allows you to scroll forward and backward through reports. Often you don't have to print a report at all. MacOneWrite can display reports on the screen as well, but you can only page forward through them—you can't go back. Also, the visual appeal of the Plains & Simple reports is generally superior to that of MacOneWrite's (see figure 6).

Plains & Simple can print any journal (the format can be quite wide,

since you can print sideways on the paper); charts of accounts; summary detailed, and trial balance sheets; summary and detailed income statements; summary and detailed aging reports for both A/R and A/P; checks; master lists, mailing labels, and Rolodex cards for customers and vendors; and aged invoices with open items or balance forward for customers. Moreover, you don't even need special forms, because the program can print lines and boxes on the invoices if you wish. Finally, Plains & Simple has a special report called the Cash Flow Calendar (see figure 7). It displays a month at a time, with three numbers on each day: receivables due, payments due, and running bank balance. At a glance, you can tell a lot about your liquid assets over time and make informed decisions about upcoming purchases, tax payments, or other financial events.

MacOneWrite can print journals; aged A/R reports; balance sheets

Cash-Flow Calendar™						
March 1986						
Sunday	Monday	Tuesday	Wednesday	Thursday	Friday	Saturday
					138	440
					6,000	7,304
					6,863	
2	3	4	5	6	7	8
0	0	0	0	0	0	0
0	0	0	0	0	0	0
7,304	7,304	7,304	7,304	7,304	7,304	7,304
9	10	11	12	13	14	15
0	0	0	0	0	0	0
0	0	0	0	0	0	0
7,304	7,304	7,304	7,304	7,304	7,304	7,304
16	17	18	19	20	21	22
7,591	0	0	0	0	0	0
14,895	14,895	14,895	14,895	14,895	14,895	14,895
23	24	25	26	27	28	29
0	0	0	0	0	0	0
0	0	0	0	0	0	0
14,895	14,895	14,895	14,895	14,895	14,895	14,895

Figure 7: Plains & Simple's Cash Flow Calendar. Note the initial balances carried over from previous months, and the payment on the 16th.

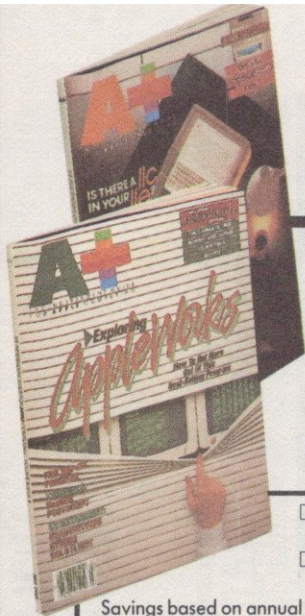

A+

Apple II/Macintosh
THE INDEPENDENT GUIDE TO APPLE COMPUTING

**THE RIGHT
CHOICE
FOR EVERY
APPLE
USER!**

- One year (12 issues) only
\$19.97—44% off!
- Two years (24 issues) only
\$35.40—50% off!

Savings based on annual newsstand price of \$35.40.

CHECK ONE: Payment enclosed. Bill me later.

Mr./Mrs./Ms. _____
(please print full name) 4S671

Company _____

Address _____

City _____

State _____ Zip _____

Add \$6 per year in Canada and all other foreign countries.
Please allow 30 to 60 days for delivery of first issue.

SAVE UP TO 50%!



A+

Apple II/Macintosh
THE INDEPENDENT GUIDE TO APPLE COMPUTING

**THE RIGHT
CHOICE
FOR EVERY
APPLE
USER!**

- One year (12 issues) only
\$19.97—44% off!
- Two years (24 issues) only
\$35.40—50% off!

Savings based on annual newsstand price of \$35.40.

CHECK ONE: Payment enclosed. Bill me later.

Mr./Mrs./Ms. _____
(please print full name) 4S671

Company _____

Address _____

City _____

State _____ Zip _____

Add \$6 per year in Canada and all other foreign countries.
Please allow 30 to 60 days for delivery of first issue.

SAVE UP TO 50%!



NO POSTAGE
NECESSARY
IF MAILED
IN THE
UNITED STATES

BUSINESS REPLY MAIL

FIRST CLASS PERMIT NO. 66 BOULDER, COLORADO

POSTAGE WILL BE PAID BY ADDRESSEE



Apple II/Macintosh

P.O. Box 2964

Boulder, Colorado 80321

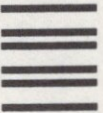

NO POSTAGE
NECESSARY
IF MAILED
IN THE
UNITED STATES

BUSINESS REPLY MAIL

FIRST CLASS PERMIT NO. 66 BOULDER, COLORADO

POSTAGE WILL BE PAID BY ADDRESSEE



Apple II/Macintosh

P.O. Box 2964

Boulder, Colorado 80321

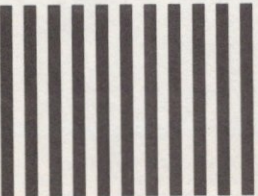

Print Income Statement

Print : On Screen On Printer

Departments : All Departments
 From to

Show : Actual Month vs. Actual YTD
 Actual Month vs. Budget Month
 Actual YTD vs. Budget YTD

Include balance thru what month ?
 January
 February

"As of" Date :

Figure 8: The choices available when you are printing an income statement with MacOneWrite

with or without budgets; trial balances; income statements with or without budgets; report-groupings lists; detailed invoices and/or statements; sales slips for cash sales; mailing labels; checks; master customer or vendor lists; vendor year-to-date lists; charts of accounts; and a special year-end report (see figure 8).

Both programs can automatically reverse an erroneous entry, and both keep an unalterable audit trail. You may encounter minor problems when you make accounting errors, but both programs catch errors in most cases before they cause any confusion. Although they do not completely protect you from the chaotic effects of sloppy or erroneous accounting, they can help immeasurably. These are excellent programs and provide error-free performance when you use them intelligently.

The two programs differ somewhat in the general ledger. MacOneWrite erases all general-journal entries after first printing and then posting them. Plains & Simple keeps all general journals intact and also makes special use of the general ledger. By examining the general ledger, you can review summaries of any transactions for any date, for any account you select. If you want to see the detail of a transaction, you can open a special Zoomed Journal that displays the transactions that occurred on a certain date that affect the specified account. This feature can help you find errors and examine the history of any specific general-ledger account.

Customer support at both companies was responsive and helpful. The people whom I called knew what they were talking about, and on the rare occasions when they did not know, they found someone who did.

LEVCO'S 2 MEG EXPANSION BOARD CREATES MONSTER MEMORY FOR YOUR MACINTOSH™

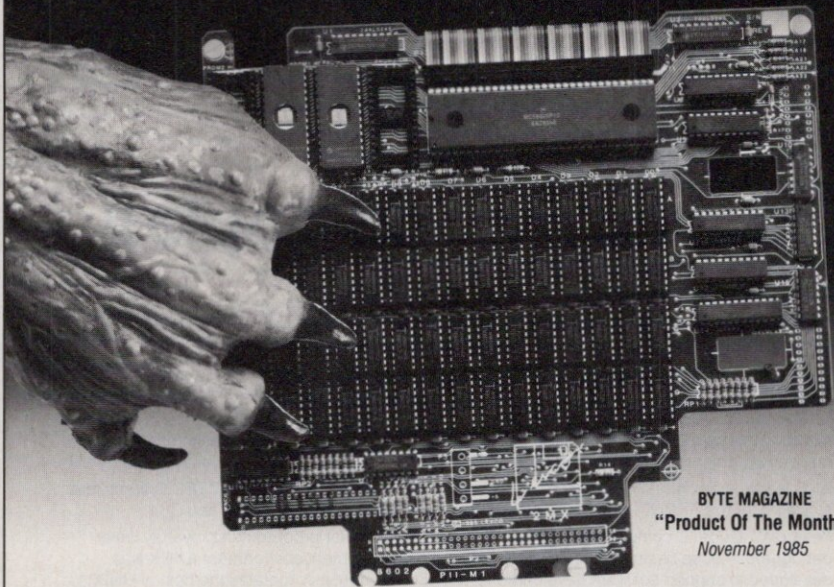

BYTE MAGAZINE
 "Product Of The Month"
 November 1985

THE MONSTERMAC™ CLIP-ON.

BOOST SPEED BY 30%

Now you can turn your friendly Macintosh into a real Monster. Levco's MonsterMac enables the memory in your computer to run up to 30% faster than a standard Macintosh. This proven upgrade also provides 256K of PROM space, and the first real Macintosh expansion port for peripherals such as the new Levco OverDrive SCSI internal 20 megabyte hard disk. The whisper-quiet Levco MacBreeze™ piezoelectric fan is included to keep your Macintosh running cool, even when the demands are hot. MonsterMac also provides a true motherboard emulation mode, to functionally "turn off" the extra memory for those rare programs that don't understand a world beyond 512K.

YOUR MOTHER WILL LOVE IT

Levco offers the MonsterMac with clip-on convenience, for simple, quick installation and no modifications to your Macintosh motherboard. MonsterMac works with old or new Apple ROMs and with either 128K or 512K Macintoshes. Most importantly, MonsterMacs are available now!

"The MonsterMac receives the highest recommendation for its speedy 2 megabytes, its compatibility with all the test software, and the lure of a real bus expansion port."
 MacWorld, February 1986



6160 Lusk Blvd.
 Suite C-203
 San Diego, CA 92121
 (619) 457-2011

SAVE \$50 ON A MONSTERMAC!

Levco is offering a \$50 rebate for those who purchase a MonsterMac before October 31, 1986. Just send this coupon to Levco with your MonsterMac order, or bring it to a participating authorized Levco dealer for an installed MonsterMac. Call Levco for the participating dealers in your area.

Customer Use

Name: _____

Company: _____

Address: _____

Phone: _____

Levco Use

Dealer: _____

Installation Date: _____

MonsterBoard Serial Number: _____

Mac Motherboard Serial Number: _____

Mail completed coupon to: Levco 6160 Lusk Blvd. Suite C-203, San Diego, CA 92121
 Offer void where prohibited by law. One coupon per customer.

MonsterMac, MacBreeze and OverDrive are trademarks of Levco. Macintosh is a trademark licensed to Apple Computer, Inc.



The C for the Macintosh and Apple II

FOR THE MACINTOSH

AZTEC C68k is the most powerful, portable, and professional C compiler and software development system for the Apple Macintosh. It is available in three configurations.

AZTEC C68k-c (Commercial System) \$499

For serious Macintosh developers who want to program in C there is no parallel to AZTEC C68k-c. AZTEC C68k-c produces smaller and faster code in less time than any system benchmarked. The supporting utilities and commands of AZTEC C68k-c create a Macintosh development environment with the power and flexibility needed for producing professional results.

All C features are faithfully supported providing portability with UNIX C and AZTEC C compilers available for the APPLE II, MS DOS, PC DOS, CP/M-86, CP/M-80, TRSDOS, and C64.

Features include: C compiler, 68000 Macro Assembler, modular programming, overlay linker, debuggers, mouse based editor, Z(Vi) editor, SHELL development environment (UNIX was developed to support software development - this environment incorporates the best of UNIX), comprehensive support of the Macintosh including the toolbox to provide straight forward development of Macintosh programs and desk accessories, make, diff, grep, terminal emulator (source), grow (source), desk accessory (source), ramdisk (source), UNIX I/O, MATH, UTILITY, and MACINTOSH run time libraries (source), full support for 512k Mac and Lisa Macworks, 600+ page manual, resource maker, calling C routines from PASCAL, PASCAL from C, and assembler subroutines, no-royalty license.

Manx support includes one year of computer tracked updates and technical telephone support.

AZTEC C68k-d (Developer's System) \$299

AZTEC C68k-d provides a less expensive development system for programmers on limited budgets. AZTEC C68k-d includes C compiler, 68000 Macro Assembler, Linker, debuggers, editor, toolbox support, run time libraries (object), sample programs (source), and a 600 page manual.

AZTEC C68k-p (Personal System) \$199

For students and professionals doing serious non-commercial work. Includes C compiler, Linker, run time libraries, sample programs (source), debugger, and editor. Restricted license.

C-TREE Database (Aztec object format) \$149

C-TREE Database (Object + Source) \$390

FOR THE APPLE II

AZTEC C65/DEV (Developer's System) \$299

This C compiler and software development system comes with C compiler, 6502 assembler, SHELL, overlay linker, UNIX I/O, Screen, and Graphics libraries, editor, utilities, and support for ProDos.

AZTEC C65 \$199

C compiler, 6502 assembler, Linker, libraries, Apple DOS 3.3 support.

AZTEC C65 Personal \$ 99

C compiler and development system. Restricted license.

MANX

TO ORDER OR FOR INFORMATION
CALL OR WRITE:

MANX SOFTWARE SYSTEMS
Box 55 • Shrewsbury, NJ 07701
TX 4995812



**CALL:
800-221-0440
201-530-7997 (NJ)**

TECH SUPPORT - 201-530-6557

CP/M-80 and CP/M-86 are trademarks of DRI Macintosh and PRO DOS are trademarks of Apple
TRS DOS is a trademark of Tandy UNIX is a trademark of ATT

CIRCLE 189 ON READER SERVICE CARD

On Balance

Although neither program is perfect, each is an excellent product that works smoothly and without errors, and they both accomplish their goals of making accounting easy and informative. Although they are designed to meet the needs of small businesses, they may, in fact, be adaptable to businesses of various sizes.

If I had to recommend one program over the other, I would find it very difficult to do so, although I personally prefer the single-disk integration of Plains & Simple since I work with a dual-floppy system. Also I prefer the full Accounts Payable module that Plains & Simple offers.

Both programs make excellent use of the special features of the Macintosh and are equally easy to use and learn. The copy-protection schemes they employ are relatively painless and unobtrusive. The visual and operational differences between the two programs are noticeable, but since both methods are appealing, a preference of one style over the other is largely subjective. I see no objective way to rate one over the other.

The best advice is to try to preview any program as complex, time-consuming, and personal as an accounting program. You'll depend on it a lot once you begin to use it, and you'll probably use it often. So it helps to like the program. **+**

Rusel DeMaria is a free-lance computer consultant and columnist for The Maui News. He lives in Hawaii.

PRODUCT INFORMATION

Plains & Simple

Great Plains Software
1701 SW 38th Street
P.O. Box 9739
 Fargo, ND 58109
(701) 281-0550

List Price: \$695

Requires: Macintosh, 512K RAM, external disk drive, ImageWriter or compatible printer

CIRCLE 375 ON READER SERVICE CARD

MacOneWrite

Sierra On-Line
Sierra On-Line Building
Coarsegold, CA 93614
(209) 683-6858

List Price: \$245

Requires: Macintosh, 512K RAM, second disk drive recommended

CIRCLE 376 ON READER SERVICE CARD

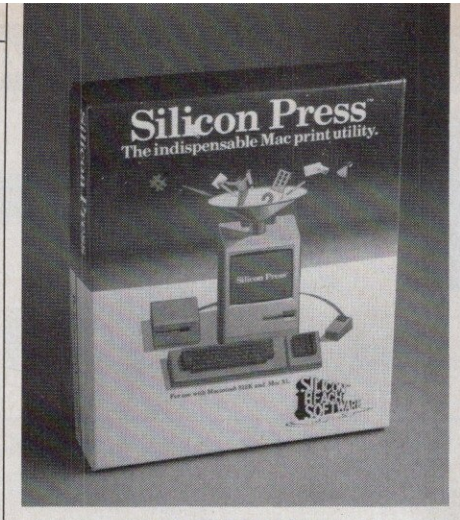

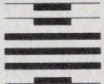
Quick  Take

BY S. VENIT

Silicon Press

Silicon Press is a program for the Macintosh that lets you create designs for cards, stickers, or labels of virtually any size and print them out in layouts of columns and rows on an ImageWriter, LaserWriter, or Epson printer. The package is a time saver for anyone who regularly prints identification tags, mailing labels, disk labels, price stickers, personalized greeting cards, or anything else that varies from the standard 8½ × 11-inch full page—from small stickers or Rolodex cards up to a 17 × 17-inch layout.

You can print rows and columns of the same image or merge data from a data file to vary the text on each label or tag. You can also include graphics imported from other programs such as MacPaint or MacDraw and print multicolored labels with an ImageWriter II with a color ribbon.

When you open a Silicon Press file, the screen displays two or three windows: a design window, which shows the design for a single label; a layout window, which shows the arrangement of labels to be printed on a full page; and (if applicable) a data window, which shows the data records to

be merged with the design in printing. The design window can include graphics (pasted in from the Scrapbook and sized to fit), text, and names from a merge file. You can have the layout window generated automatically or arrange it manually and can type records directly into the data window or copy them in from a data-

base or merge file. Silicon Press uses the same data-merge conventions as that Microsoft Word does: The fields in each record are separated by commas,

the first record in the data file (the header record) lists the field names as used in the merge file, and the merge file identifies field names by enclosing them in international quote marks, also called data-merge marks (« and »).

The feature that makes Silicon Press a desirable replacement or supplement to any database program is its convenience and flexibility in sizing labels and designing full-page layouts. The program automatically sizes the design window for you when you choose the Set Design menu option and specify the size of the label. Similarly, it generates the layout window automatically when

you choose the Automatic Layout menu option and specify the horizontal and vertical spacing between labels and the number of rows and columns on a single page. With both options, you can enter sizes in inches or points, you can enter inch measures in decimals or fractions, and the Preferences command lets you choose centimeters instead of inches.

One chronic problem with special formats—no matter what printer or program you use—is aligning the paper precisely in the printer. Typically, you end up wasting a lot of labels in test runs before arriving at the correct positioning. Silicon Press doesn't eliminate the need for trial and error in paper alignment, but it does offer a feature to make this process less wasteful: the Test Print option lets you print one label or one page of labels, showing a dotted rectangular outline around each label. This way, you can make fine adjustments to your on-screen layout before the final print run, and you can use normal paper to test your printout before loading the label paper. Furthermore, when you're print-merging with a data file, the Test Print option prints only one label at a time and positions the print head at the top of the next label, rather than rolling forward a full page as some other merge programs do.

In short, after having tried to produce custom-size labels using various options and combinations of MacWrite, MacPaint, Microsoft Word, Microsoft File, MacDraw, PageMaker, OverVUE, BASIC, and PostScript code, I tend to agree with the claim printed on the Silicon Press package: Silicon Press is "The indispensable Mac print utility" for anyone who regularly prints labels. **+**

S. Venit is a principal in TechArt in San Francisco, a graphics-production and typesetting shop that uses Macintoshes and LaserWriters.

PRODUCT INFORMATION

Silicon Press

Silicon Beach Software, Inc.
P.O. Box 261430
9580 Black Mountain Road, Suite E
San Diego, CA 92126
(619) 695-6956

List Price: \$79.95

Requires: Macintosh, 512K RAM

CIRCLE 380 ON READER SERVICE CARD

CALL TOLL FREE 1-800-382-2242

NEAR THE WE WILL BEAT

7 Trap Falls Rd. Shelton, Connecticut 06484 (See Below)

- Tap our unmatched selection and inventory of software/hardware for the Mac and Apple (as well as the IBM PC and Commodore Amiga).
- School and corporate purchase orders are welcomed. CALL 1-800-874-1108.
- Special/rush orders. If something you need is not listed, hard to find, or needed in a hurry, CALL 1-800-874-1108.
- Order Status. CALL (203) 375-3860.
- Ask for System Sales when ordering a complete system.
- FREQUENT PURCHASER PROGRAM. Any repeat customer will automatically receive \$1 off any order he or she places with us. Please mention to your operator that you are a repeat customer. We value your continuing business. Send in \$1,000 worth of invoices (representing previous purchases) and you will receive a coupon worth 1% off any future purchase. With \$5,000 worth of invoices, receive a coupon worth 5% off any future purchase.
- No additional charges for credit card orders.
- Convenient hours. 7 days/week: 9AM-11 PM EST.
- FREE AIR EXPRESS SHIPPING. Purchase \$150 or more of software and for no additional charge we will ship your products by air courier. Mention this to your operator as you place your order.
- FURTHER DISCOUNTS BY MAIL. Circle the items in our ad you want, send the aid in with the coupon below and receive \$.50 off each item! Cut out a competitor's ad with a lower price and we will give you \$1 off his price (subject to the conditions below).

SPECIALS

ORIGIN SYSTEMS

Moebius	35.00
Ultima IV	33.00
MICROPROSE	
Silent Service	19.50
MEGAHAUS	
Spellworks	26.00
Reportworks	65.00
Megaworks	65.00
PBI	
Jeeves	29.00
PINPOINT PUBLISHING	
Pinpoint	33.00
MINDSCAPE	
Kambo	22.50
AVALON HILL	
Under Fire	32.00
BASF	
BASF SSS/DD	9.50

COPY PROGRAMS/BOARDS

Back It Up III	38.00
CIA Files	22.00
Copy II+	17.50
Copy Masters II 128K W/GR Dump.	88.00
EDD IV Plus II/II+/IIE	37.00
EDD IV Plus IIE/W/Duo/Uni Disk	39.00
Locksmith 8.0	56.00
Nibbles Away III	57.00
Wildcard II	90.00

BUSINESS

Advanced Logic Systems	
The Handlers Package	51.00
List or Word Handler	36.00
Spellworks	26.00
APPLE	
Appletworks	CALL
Appletwriter II	CALL
Apple Access	CALL
Quickfile	CALL
APPLIED SOFTWARE TECHNOLOGY	
Versaform	43.50
ARTSCL	
Magic Office Systems	142.00
Magic Calc 3.3	55.00
Magic Windows	86.00
ASITON TATE	
Debase II	277.00
BPI	
Gen. Accts. AR, AP, GL, PAY	192.00
Gen. Accts. AR, AP, GL, PAY PRO DOS	207.00
BRODERBUND	
Bank Street Filer	39.00
Bank Street Speller	39.00
Bank Street Writer 64K or 128K	39.00
Bank Street Mailer	39.00
CBS SOFTWARE	
Stackpak II	87.00
CONTINENTAL SOFTWARE	
Home Accountant IIE	40.00
Home Accountant IIE	37.25
Tax Advantage	36.00
DOW JONES SOFTWARE	
Investor's Workshop	76.00
Market Analyzer or Microscope	175.00
Mkt. Mgr. or Spreadsheet Link	125.00
Membership Kit	18.00
ELECTRONIC ARTS	
Financial Cookbook	31.00
Cut & Paste	20.00
FUNWK	
Sideways	30.00
HAYDEN SOFTWARE	
The Writer	22.50
HOWARDSON	
Real Estate Analyzer III	169.00
INTERNATIONAL SOLUTIONS	
Mouse Budget	39.00
Mouse Calc	84.00
Mouse Desk	84.00
Mouse Word	75.00
Mouse File	CALL
INTUIT	
Quick	49.00

KENSINGTON

Format II Enhanced	84.00
LIVING VIDEOTEK	
Think Tank II/IIE	75.00
MEGAHAUS	
Megaworks	65.00
Reportworks	65.00
Thinkworks	65.00
MANZANITA	
Business Accountant System MAG	66.00
Business Accountant GL/AP/AR/INV	195.00
Business Accountant Payroll	225.00
Adv. Business Acct. System MAG	66.00
Adv. Business Acct. GL/AP/AR/INV	255.00
Adv. Business Acct. Payroll	275.00
Businessworks Syst. Manager	50.00
Businessworks GL/AP/AR/INV	205.00
Businessworks Payroll	230.00

MECA	
Managing Your Money	100.00
MICROPRO	
Wardstar	168.00
MICROSOFT	
Multiplan	54.00
MONOGRAM	
Dollars & Sense	66.50
Dollars & Sense IIC	66.50
Forecast	34.00
Nolo Press	
Will Writer	23.00
PBI SOFTWARE	
Graphworks	56.00
Jeeves	29.00
PEACHTREE	
Back to Basics	95.00
PINPOINT PUBLISHING	
Pinpoint	35.00
Pinpoint Spelling Checker	34.00
Pinpoint Toolkit	CALL
PRACTICORP	
Practical II	25.00
PRECISION SOFTWARE	
Superbase	52.00
QUARK	
Word Juggler W/Laxicheck	55.00
Catalyst IIE	55.00
ROGER WAGNER PUBLISHING	
Mouse Write	68.00
The Write Choice	25.00

ROLODEX	
Rolodex Compucard	33.75
Rolodex Label Express	33.75
SATELLITE SOFTWARE	
Word Perfect	77.00
SCARBOROUGH	
Ner Worth	45.00
SENSIBLE SOFTWARE	
Bookends or Sensible Speller	63.00
The Graphics Department	63.00
Sensible Grammar	50.00
Report Card	30.00
SIERRA-ON-LINE	
The General Manager II	127.00
Homeward/Speller Bundle	40.00
Screenwriter IIE	73.00
Homeward Filer	40.00

SIMON & SCHUSTER	
JK Lessers Income Tax	45.00
JK Lessers Money Manager	45.00
SORCIM	
Supercalc 3A	97.00
SOFTWARE PUBLISHING	
PFS: First Success	126.00
PFS: Access	43.00
PFS: File or Graph	68.00
PFS: Report or Write	68.00
STATE OF THE ART	
Electric Checkbook	56.00
STONEWARE	
DB Master 4 Plus	167.00
DB Bus. Pack or Mast Bus. Team	187.00
DB Master Business Writer	83.00
TIMWORKS	
Silvia Porter's Financial Plan	55.00
Swiftcalc with Sideways	99.00
TURNING POINT	
Time is Money	56.00
UNISON	
Printmaster	28.00
VIRTUAL COMBINATICS	
Micro Cookbook II/IIE	20.50
VISICORP	
Flashcalc	50.00

ANIMATION/GRAPHICS SOFTWARE

ACTIVISION	
Game Maker	29.00
BAUVILLE	
Blazing Paddles	16.00
Heroes and Villains	16.00
Pix It	27.00
Prince	40.00
Shape Library 1, 2 or 3	10.75
Take 1	31.50
BEAGLE BROTHERS	
Beagle Graphics	29.50
Frame Up	14.50
Alpha Plot	20.00
Flex Text	14.50
Shape Mechanic	20.00
BRODERBUND	
Dazzle Draw	34.00
Fantavision	27.00
Print Shop	26.75
Print Shop Companion	22.50
Graphics Library 1	14.00
Graphics Library 2	14.00
Graphics Library 3	14.00
Refill Paper Pack	12.25

DATA TRANSFORMS	
Fontrix	46.00
Font Packs 1-13	11.50
ELECTRONIC ARTS	
Movie Maker	25.00
PENGUIN	
New Complete Graphics System	44.50
Graphics Magician	33.50
SENSIBLE SOFTWARE	
Graphics Department	62.00
SOFTWARE PUBLISHING	
PFS: Graph Dos or Pro Dos	67.50
SPINNAKER	
Delta Drawing	22.50
SPRINGBOARD	
Clip Art Collection Vol. 1	16.00
Clip Art Collection Vol. 2	19.00
Graphics Expander	21.00
Newsroom	30.00
WEEKLY READER	
PIC Builder	20.00
Zoom Graphics	35.00

UTILITY SOFTWARE /LANGUAGES	
BEAGLE BROTHERS	
Apple Mechanic	15.00
Beagle Basic	17.50
D-Code	20.00
Disk Quick	14.50
Dos Boss	12.00
Double Take	17.75
Extra K	20.00
Fat Cat	73.00
Flex Text	15.00
GPLE	25.00
I/I Silver	15.00
Mini Pix	14.75
Font Mechanic	14.75
Big U	17.00
Pro Byter	17.00
Pronto Dos	14.50
Silicon Salad	12.50
Triple Dump	19.00
Type Faces	10.00
Utility City	14.50
BORLAND	
Turbo Pascal	35.00
Turbo Database Toolbox	28.00
Turbo Turbo	17.50
KENSINGTON MICROWAVE	
System Saver	56.50
LAZERWARE	
Lisa V2.6	52.50
MICROSOFT	
Applesoft Compiler	101.00
PERFECT DATA	
Perfect Data Head Cleaning Kit	8.00
QUALITY	
Bag of Tricks II	27.00
ROGER WAGNER	
Merlin	33.75

Merlin Combo	60.00
Merlin Pro	54.50
Visible 6502	32.00
VIDEX	
Ultraform W/SS INV.	175.00
Video 7 RGB Interface IIE	110.00
Video 7 RGB Interface IIC	81.00

EDUCATIONAL

ADDITION WESLEY	
Smart Eyes	34.00
APPLE	
LOGO II	CALL
BANTAM BOOKS	
Road Rally USA	22.50
Scarsole Diet	22.50
BARRONS	
Barrons SAT	34.00
BRAINPOWER	
Chipwits	22.50
Thinkfast	20.00
BRODERBUND	
Science Toolkit	33.00
CBS	
Adventure Master	15.00
Body in Focus	20.00
Dinosaur Dig	20.00
Mastering the SAT	50.00
America Coast to Coast	20.00
Goren's Learning Bridge	40.00
Forecast or T-Rex	25.00

DAVIDSON AND ASSOCIATES	
Alge Blaster	25.00
Speed Reader II	35.00
WORD ATTACK, MATHBLASTER	
Or Spell It	25.00
All Davidson Data Disks	10.00
Classmate	25.00
DESIGNWARE	
Spellcapter or Spellokazam	20.00
States & Traits and European Nations	22.50
Body Transparent or Mission Alphabet	22.50
Grammar Examiner	22.50
Remember	40.00
DLM	
Alien Addition or Alligator Mix	17.00
Meteor Mult. or Minus Mission	17.00
Demolition Division or Dragon Mix	17.00
Spelling Whiz or Word Invasion	17.00
FREDDIE'S PUZZLES	17.00
CREATE WITH GARFIELD	17.00

EDU-WARE/PEACHTREE	
Compu Read	15.00
SAT Word Attack Skills	15.00
Spelling Bee Games	20.00
Algebra 1, 2, 3 Or 4	20.00
Algebra 5 & 6	25.00
Writing Skills 1, 2, 3, 4, 5	20.00
Hands on Basic	24.50
Introduction to Counting	18.50
Fractions or Decimals	19.00

FISHER PRICE	
Alpha Build	23.00
Peter Rabbit Reading	23.00
HARCOURT BRACE JOVANOVIH	
Harcourt SAT	44.00
Harcourt GRE or ACT	50.00
GROLIER	
Science Island or Treasure Hunt	22.50
Easy Graph or Friendly Filer	22.50
Educual	28.00
HAYDEN	
Word Challenge	10.00
LEARNING COMPANY	
Rocky's Boots or Robot Odyssey	28.00
Number Stumper or Reader Rabbit	22.50
Magic Spells or Word Spinner	19.50
Bumble Games or Bumble Plot	22.50
Gertrude's Puzzles or Secrets	24.75
Addition Magician	19.50
Juggles Rainbow	17.00
Moptown Hotel	22.50

MAGNUM	
Super Speed Reading	30.00
MECC	
Elementary Series (Each)	29.00
Math or Health Series (Each)	29.00
MICROSOFT	
Typing Tutor II	14.75

Send coupon and list of items desired to DISCOUNT BY MAIL DEPARTMENT
Northeastern Software, 88 Ryders Lane, Stratford, CT 06497

To be eligible for the \$1.00 per item discount you must:
1. Fill out all items. 2. Send in our ad with the items you desire circled.

Name _____
Address _____ (Include Company Name)
City _____ State _____ Zip _____
Phone No. at above address _____
Check form of payment _____
 Visa MasterCard C.O.D. Personal Check
 Certified Check Money Order
 Card No. _____ Exp. Date _____
 Computer Model _____

Personal and company checks allow 3 weeks to clear. For faster delivery, send cashier's check, certified check, or money order. Shipping—Software (\$3.00 minimum). Shipping—Hardware (please call 203-375-3860). COD—Add an addition \$2.00. Alaska, Hawaii, Canada, PO, APO, and FPO \$5.00 minimum. Foreign orders—\$15.00 minimum and 15% of all orders over \$100. Mastercard and Visa (please include card no. and expiration date). Connecticut residents add 7.5% sales tax. Prices subject to change without notice. All returns must have a return authorization number. Call 203-375-3860 to obtain one before returning goods for replacement. Defective merchandise replaced with same item only. We do not guarantee compatibility. All sales are final. "Comparable advertised price" does not include typographical errors on the part of other vendors or prices that do not reflect higher shipping costs, credit card charges, or membership fees. The \$1 off offer only applies to items where Northeastern's price is not already the lowest. Final judgment remains with the manager on duty.

ASTER

ANY COMPARABLE ADVERTISED PRICE BY \$1

MILLIKEN	BANTAM PUBLISHING	ODESTA	CH HAYES	NEC INFORMATION SYSTEMS	INFORMATION APPLIANCE, INC.
Math Sequences (Each) 19.50	Escape or Cave of Time 21.00	How About a Nice Game of Chess 20.00	Hayes Mac II 25.00	2030 605.00	Swiftcard 68.00
Miliken Word Processor 40.00	Fourth Protocol 23.00	ONE STEP SOFTWARE	Hayes Mac III 30.00	3530 750.00	PRACTICAL PERIPHERALS
MINDSCAPE	I'Domiano The Wizard 23.00	Golf's Best Pinehurst 28.00	INNOVATIVE TECHNOLOGIES	P2 480.00	Prodock IIE or IIC 90.00
Perfect Score SAT 39.50	Sherlock Holmes Another Bow 23.00	Golf's Best St. Andrews 28.00	Flig N File 50 10.00	P3 670.00	QUADRAM
Keyboard Cadet 23.00	BLUE CHIP	ORIGIN SYSTEMS	KEYTRONICS	ELF 360 370.00	Quadram PRO DOS Clock/Calendar 59.00
Luscher Profile 23.00	Millionaire, Baron or Tycoon 22.50	Auto Duel 30.00	KB 200 179.00	OKIDATA	Quadram Extended Multifunction 155.00
SCARBOROUGH SYSTEMS	Squire 22.50	Moebius 35.00	KDALA TECHNOLOGIES	182P CALL	Quadram Buffered Serial Int. 95.00
Build a Book About You 15.00	BRÖDERBUND	Ultima III 33.25	Kaolo Pad 70.00	192P CALL	Quadram Parallel Interface 65.00
Boston Computer Diet 45.00	Ancient Art of War 22.50	Ultima IV 33.00	Gibson Light Pen 33.00	192P CALL	Quadram Parallel Card w/Graphics 70.00
MasterType's Writing Wizard 40.00	Captain Goodnight 19.50	PENGUIN	Muppet Learning Keys 41.50	193P CALL	Quadram 80 Column 64K Card 97.00
MasterType's Filer 22.50	Championship Loderunner 19.50	Coveted Mirror 19.50	KRAFT	193 Imagewriter 25.00	Quadram Multi-Core Board w/256 175.00
MasterType's New and Improved 22.50	Choplifter 19.50	Crimson Crown 19.50	Kraft Joystick IIC or IIE 25.00	Okimate 20 Color 132.00	Quadram E-Ram 80 96.00
Run for the Money or Songwriter 12.00	Lode Runner or Karateka 22.50	The Quest or Ring Quest 19.50	MCT	PANASONIC	STREET ELECTRONICS
Picture Writer 22.50	Mask of the Sun 22.50	Xybus or Transylvania 19.50	MCT Speed Demon 132.00	KXP 1091 240.00	Alphabits II CALL
SCHOLASTIC WIZWARE	Serpents Star 22.50	POLARWARE	STREET ELECTRONICS	KXP 1092 329.00	Livewire w/Clock 63.00
Fact and Fiction Toolkit 22.50	Where... Is Carmen San Diego 22.50	Sword of Kadash 19.75	Echo II Plus 91.00	KXP 3131 185.00	Business Card Serial 131.00
Microzine 1-8 (Each) 20.00	CBS SOFTWARE	RANDOM HOUSE	Cricket IIC 63.00	KXP 3151 395.00	Business Card Parallel 154.00
Story Tree or Story Maker 20.00	Murder by the Dozen or Felony 15.00	Alpine Encounter 23.00	TITAN TECHNOLOGIES	QUME	THUNDERWARE
Turtle Tracks or Agent USA 20.00	DATAISOFT	SEGA	Accelerator IIE 203.00	Letter Pro 20 415.00	Thunderdock Plus 100.00
Operation Frog or Logic Builder 20.00	Alternate Reality 25.00	Frogger 3-Deep or Super Zaxxon 19.50	Srtum 128K Ramcard CALL	SILVER REED	
Lego Robot or Kids At Work 12.50	Bruce Lee or Conan 20.00	Spy Hunter or Buck Rogers 25.75	SWEET MICRO	Exp 400P 200.00	
SENSIBLE SOFTWARE	Koronis Rift 23.00	Topper or Star Trek 25.75	Exp 500P 185.00	Exp 550P 360.00	
Report Card 32.00	Zorro or the Goonies 20.00	SIERRA ON LINE	Exp 770P 655.00	Exp 800 CALL	
SIMON AND SCHUSTER	Mr. Do 20.00	King's Quest I or II 28.00	STAR MICRONICS		
Chem Lab 22.50	ELECTRONIC ARTS	The Black Cauldron 23.00	SG 10 215.00		APPLE COMPUTER
Lovely's Preparation for the SAT 39.00	Adventure Construction Set 28.00	SIMON AND SCHUSTER	SG 15 369.00		Apple Access CALL
Typing Tutor III 26.00	Archon 21.00	Super Zaxxon 20.00	SD 10 329.00		COMPUERVE
SPINNAKER SOFTWARE	Archon II or Skyfox 24.00	Frogger 3 Deep 20.00	SD 15 439.00		Compuserve Starter Kit 18.00
Fracton Fever or Face Maker 24.00	Bard's Tale or Reach for the Stars 27.00	Spy Hunter, Topper or Star Trek 25.50	SR 10 479.00		DOW JONES
File and Report or Spreadsheet 33.50	Corries at War 30.00	SIR TECH	SR 15 579.00		Spreadsheet Link 127.00
Snooper Traps I or 2 18.50	Europe Ablaze 30.00	Wizardry I 19.50	SR 15 579.00		Doc Jones Starter Kit 23.00
Story Machine or Grandma's House 14.00	Music Construction Set 24.00	Wizardry II 19.50	SHIMIBA		
Kindercomp or Kids On Keys 14.00	One-On-One 24.00	Wizardry III or Wizardry IV 22.50	P351 1015.00		HAYES
Spinnaker Word Processor 33.50	Pinball Construction Set 21.00	Wizardry 14.00	A2 143K 145.00		Smartcom I 67.00
Alphabet Zoo or Kidwriter 16.75	Seven Cities of Gold 24.00	SPECTRUM HOLOBYTE	Slimline IIE 145.00		Hayes Terminal Program 54.00
In Search of 16.75	Wilderness 31.00	Gato 20.00	Slimline IIC 145.00		
Adventure Creator 16.75	Chessmaster 2000 2.400	STRATEGIC SIMULATIONS	Controller Card 45.00		
Trains 16.75	Murder on the Zinderneuf 13.00	50 Mission Crush 22.50	Quark 950.00		MONITORS
Counting Parade 16.75	Super Boulder Dash 21.00	Baltic 85 or Gemstone Warrior 19.50	OC-10 Hard Disk 1325.00		
Sum Ducks 16.75	Skyfox 24.00	Battalion Commander 22.00			APPLE
Delta Drawing 22.50	Lords of Conquest 21.00	Battle for Normandy 22.00			Color Monitor IIE or IIC CALL
Homework Helper: Math Problems 22.50	Ogre 31.00	Germany 1985 or Carrier Force 33.00			AMDEK
Homework Helper: Writing 22.50	EPXY	Imperium Galacticum or Broadside 22.00			Color 300 202.00
SPRINGBOARD	Ballblazer 22.50	North Atlantic 86 33.00			Color 600 373.50
Early Games or Piece of Cake 18.50	Rescue on Fractalus 22.50	Objective Kursk or Phantasie 22.00			Video 300A Amber 115.00
Make A Match or Wraction Factory 15.50	Summer Games I or II 22.50	Operation Market Garden 28.00			Video 300G Green 110.00
Mask Parade 20.50	Temple of Asphi Trilogy 22.50	Question 28.00			DWM III 115.00
Easy As ABC 20.50	Winter Games 22.50	Reforger 88 or Kampfgruppe 19.00			PRINCETON
Mathbusters 17.00	World's Greatest Baseball Game 17.00	USAAF 31.00			HX-9 385.00
Music Maestro 17.00	World's Greatest Football Game 17.00	War in Russia 45.00			HX-12 400.00
Rainbow Painter 17.00	HAYDEN	SUB LOGIC			RGB Interface 138.00
Puzzle Master 17.00	Sargon III 27.25	Flight Simulator II 30.50			TAXAN
TERRAPIN	Computer Novel Const Set 28.00	Night Mission Pinball 20.75			115 Green 108.00
Terrapin Logo 50.00	Holy Grail 28.00	SYNAPSE SOFTWARE			116 Amber 113.00
Terrapin Logo 10 Pack 149.50	Inca 28.00	Brimstone 25.50			610 300.00
TIMEWORKS	INFOCOM	Mindwheel or Essex 25.50			620 380.00
Evelyn Wood Dynamic Reader 38.75	A Mind Forever Voyaging 24.50	TELARIUM			630 415.00
WEEKLY READER	Cutthroats or Zork I 21.75	Dragonworld or Shadowkeep 22.00			640 485.00
Exploring Tables and Graphs 17.50	Spellbreaker 27.00	Forenheit 451 or Amazon 22.00			
Sticky Bear Series (Each) 20.00	Spellbringer 27.00	Rendezvous with Rama 21.75			
	Deadline, Suspended or Starcross 27.00	Nine Princes in Amber 2.200			
	Hitchhiker's Guide to the Galaxy 21.75	Perry Mason 22.00			
	Planetfall or Enchanter 24.50	Windham Classics 17.50			
	Sorcerer, Suspect or Infidel 24.50	Below the Root 17.50			
	Witness or Seastalker 24.50	Swiss Family Robinson 17.50			
	Zork II or Zork III 24.50	Treasure Island 17.50			
	MICROPROSE	Wizard of Oz 17.50			
	Crusade in Europe 22.50	BLANK MEDIA			
	Decision in the Desert 22.50	Elephant SS/DD 9.00			
	F-15 Strike Eagle or Solo Flight 19.50	Elephant DS/DD 11.00			
	Gunship 19.50	Verbatim SS/DD 22.50			
	Silent Service 19.50	Verbatim DS/DD 17.50			
	NATO Commander 19.50	Memorex SS/DD 9.50			
	Conflict in Vietnam 22.00	Maxell SS/DD 12.50			
	Acrojet 19.50				
	MICRO LEAGUE SPORTS				
	Micro League Baseball 22.00				
	Micro League Managers Disk 22.00				
	MINDSCAPE				
	Crossword Magic 28.00				
	Halley Project 25.00				
	James Bond View to a Kill 22.00				
	Rambo 22.00				
	Steven King The Mist 22.00				
	Voodoo Island 22.00				
	Deja Vu 32.00				
	Forbidden Castle 22.00				
	Racter 25.00				
	ACCESSORIES/TURBO BOARDS				
	APPLE COMPUTER				
	Apple Mouse IIC CALL				
	Apple Mouse IIE CALL				
	Appleworks Modifier 64K 37.50				
	Appleworks Modifier 128K 47.50				
	APPLE				
	Imagewriter II w/Acc. Kit CALL				
	Imagewriter 15" w/Acc. Kit CALL				
	Laserwriter CALL				
	BROTHER				
	HR-15 XL 360.00				
	HR-25 585.00				
	HR-35 705.00				
	CITIZEN				
	MSP-10 245.00				
	MSP-15 345.00				
	MSP-20 310.00				
	MSP-25 465.00				
	EPSON				
	Spectrum LX-80 CALL				
	Spectrum LX-90 w/Acc. Kit CALL				
	FX-80 Color Printer 12.00				
	FX-185 17.50				
	LQ-800 11.50				
	LQ-1500 9.50				
	DX-10 12.50				
	DX-20 CALL				
	AP-80 Imagewriter CALL				
	JUKI				
	Juki 5500 Color 360.00				
	Juki 6100 648.00				
	Juki 6300 CALL				
	MANNESMAN TALLY				
	MT-85 355.00				
	MT-86 410.00				
	CREATIVE PERIPHERALS				
	Time Trax IIE or IIC 76.00				
	APPLIED ENGINEERING				
	Trans Warp Accelerator CALL				
	Ramworks II CALL				
	RGB Option 97.00				
	Z Ram IIC 244.00				
	System Clock 60.00				
	Viewmaster 102.00				
	Timemaster H.O. 97.00				
	BSR Option 37.00				
	Z-80 Plus 103.00				
	APRICORN				
	Apricorn 16K Ram Card 62.00				
	Apricorn 64K Extend It 40.00				
	AST RESEARCH				
	AST Micro Star (10mg HD w/8U.) 1750.00				
	AST Multi I/O 140.00				
	CHECKMATE TECHNOLOGIES				
	Checkmate Zee-80A Card 64.50				
	Checkmate IIE-80 Ram Card 56.50				
	Checkmate Multiram C (256K) 245.00				
	Checkmate Multiram C (512K) 310.00				
	Checkmate Multiram IIE 129.00				
	TELECOMMUNICATIONS SOFTWARE				
	Thunderdock Plus 100.00				
	APPLE COMPUTER				
	Apple Personal Modem w/AcKit CALL				
	HAYES				
	Hayes Smartmodem 300 132.00				
	Hayes Smartmodem 300 IIC 152.00				
	Hayes Smartmodem IIE w/SC I 128.00				
	Hayes Smartmodem 1200 360.00				
	Hayes Smartmodem 2400 570.00				
	PRENTICE				
	Popcom X-100 Modem 244.00				
	PROMETHEUS				
	Prometheus 1200 External 267.00				
	Prometheus Internal IIE/II+ 255.00				
	ZOOM TELEPHONICS				
	Zoom Modem IIE 90.00				
	Zoom Modem IIE Plus 100.00				

MacTips

Suggestions from our readers

MAKING MIMEOGRAPH STENCILS

Mimeograph machines cannot reproduce halftones reliably, which limits mimeographed pictures to line drawings. The Mac doesn't produce halftones, which are dots of different sizes, though, but makes lines and shades of gray by using dots of the same size with different spacings. As a result, stencils from the Mac and ImageWriter produce good graphics on a mimeograph. Tests with my mimeograph machine show that the Mac does a better job than the expensive electronic stencil machine I have, and it does so with the cheaper standard stencil!

I was able to make stencils on the ImageWriter by removing the ribbon, setting the page size to 8½ × 14 inches, and setting the paper-thickness lever inside the ImageWriter to the four-sheet form thickness.

David Smith
Mendham, NJ

UNOBSCURED OBJECTS

While using MacPaint, I accidentally noticed something strange happen when I was attempting to move selected objects around the screen. When you move the arrow from the selected object, it has the shape of a lasso. When the lasso leaves the bottom of the screen, it becomes an arrow again. If you click the mouse at the area where the lasso changes to an arrow at the bottom or side of the screen, you can still move the object that you selected.

This observation may not seem like anything too important, but it has proven to be very useful. Often, when moving small selected objects, I've found that the arrow obscures the object, thereby making it difficult to place. Not anymore. Now I just move the lasso to where it becomes an arrow again at the bottom of the

screen, and I can move the object without the arrow being on top of it (see figure 1).

John Hayes
Lima, Peru

KEYBOARD SWITCHER SETS

Macintosh users who use Switcher quickly realize that the most efficient strategy is to save the program configurations you use most often as Switcher "sets." Then, when you want to install your programs in Switcher, you select Load Set from the File menu and choose the appropriate set from the dialog box.

For those of us who like to use the keyboard, Andy Hertzfeld was kind enough to install ⌘ key equivalents for the most frequently used Switcher commands, including Load Set. To choose a Switcher set from the Load Set dialog box, however, you must

type a significant portion of the Set's filename.

Keyboard users take heart! By beginning your Switcher-set filename with a number (see figure 2), you can select the appropriate Switcher set with only one or two additional keystrokes. For example, to load the Excel/Word/Sidekick set in figure 2, you type

Command-L, 3, Return

Although Switcher is the prime example here, this technique works with any application in which you want to load files quickly from the keyboard each time you use the program. Microsoft Word glossaries, File report formats, and Excel macro-sheets are other likely candidates for taking advantage of this MacTip.

David K. Simerly
Mountain View, CA

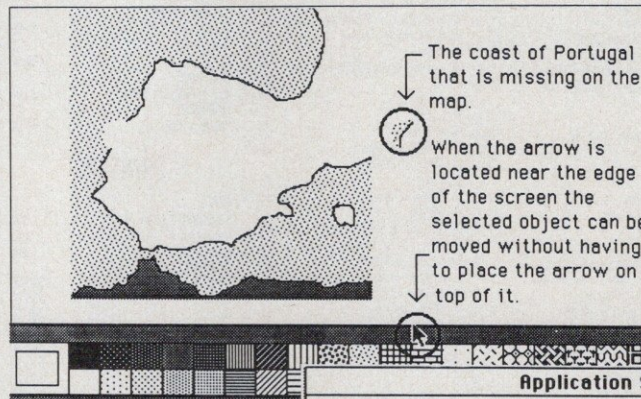

Figure 1: Moving objects in MacPaint without an obscuring arrow

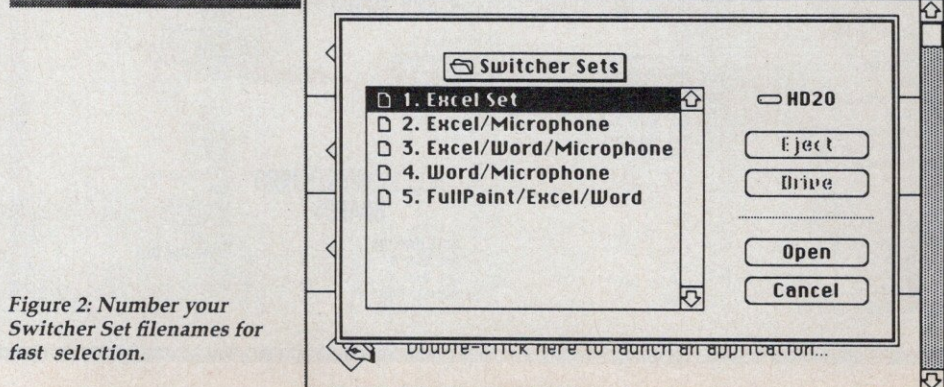

Figure 2: Number your Switcher Set filenames for fast selection.

BACKUP YOUR DISKS

EDD Version 4 is the most powerful copy program available for backing up "uncopyable" or "copy-protected" disks. ■ In addition to backing up disks, **EDD 4** also features a hi-resolution graphic DISK SCAN option to help you locate information on a disk, a CERTIFY DISK option for certifying blank disks, and since it's very important that your disk drives are running properly (especially when copying disks), we have also included an EXAMINE DISK DRIVE option. ■ Even though **EDD 4** has been preset to copy the broadest range of copy-protections possible, **EDD 4** can be "modified" to back up almost any disk that runs on your Apple! ■ For the dedicated user, in addition to **EDD 4**, we are offering an **EDD 4 PLUS** version that includes a specially designed hardware card which allows **EDD** to copy EVERY bit of information from each track accurately! You can bet that if **EDD 4 PLUS** can't copy it, nothing will! ■ **EDD 4** runs on an Apple II, II Plus (including most compatibles, IIe, IIc, and III (using emulation mode), and is priced at \$79.95. ■ **EDD 4 PLUS** runs on Apple II, II Plus (including most compatibles), and IIe, and is priced at \$129.95 (duodisk/unidisk 5.25 owners must add \$15 for a special cable adapter). Ask for **EDD** at your local dealer, or to order direct, include \$3 (\$6 foreign) shipping/handling for **EDD 4**, or include \$5 (\$8 foreign) for **EDD 4 PLUS**. ■ Mastercard and Visa accepted. All orders must be prepaid. ■ If you have an earlier version of **EDD**, you can update to **EDD 4** or **EDD 4 PLUS** at a reduced price. Send your **EDD** disk to us, and deduct \$50 from your order.

EDD is sold for the sole purpose of making archival copies *ONLY!*

UTILICO MICROWARE

3377 SOLANO AVENUE / SUITE 352 / NAPA, CA 94558 / 707-257-2420

ESSENTIAL DATA DUPLICATOR 4

CIRCLE 190 ON READER SERVICE CARD

When you find a toll-free number in an ad, make sure you use it! It means you will get faster service. When you call an advertiser's toll-free number, be sure to tell them "I saw your ad in A+ Magazine."

Pipeline

STAR NB-15 PRINTER

Star Micronics has introduced the NB-15, a 24-wire, dot-matrix printer that offers 100-cps letter-quality and 300-cps draft-quality printing. The printer also has a 16K buffer and twin front-panel slots that accept a choice of five font cartridges. The front-panel displays and selector buttons offer 19 command selections, including three font styles, two print modes, eight form lengths, and margin adjustments. The printer also has a rear tractor feed with a quick-tear feature.

(List Price: \$1449)

Star Micronics, Inc.
200 Park Avenue
Suite 3510
New York, NY 10166
(212) 986-6770

CIRCLE READER SERVICE NO. 500

PERIPHERAL LAND DISK DRIVES

Peripheral Land has introduced several hard-disk drives and a tape backup system for Macintosh and Mac Plus computers.

The hard-disk drive Macfast is available in 10-,

20-, and 30-megabyte configurations and comes with a high-speed QIC-2 tape-interface port for use with a streaming-tape drive for making backups. Macstor 10 is a hard-disk drive that uses 10-megabyte cartridges to provide unlimited storage capacity and data security. It also features a closed loop servo for precise head-to-track accuracy. Both Macfast and Macstor attach directly to the computer's system bus via a SCSI interface and are compatible with both the Macintosh and the Macintosh Plus. The firm includes a SCSI-interface adapter card free with all units for 512K Macs.

Designed for the Mac Plus, the PL-20 is a 20-megabyte hard-disk subsystem that also attaches to a computer's SCSI port.

All the above drive units support both HFS and MFS partitioning, use 5 1/4-inch Winchester-plated media, have built-in cooling fans, and are easy to

install. Carrying cases are also available.

For use with Macfast 20 and Macfast 30, the Macfast 20 Tape is a 20-megabyte tape-drive subsystem that uses standard CT-500 digital cassette cartridges. The unit connects to the Macfast drive through its QIC-2 tape interface. The firm includes all software and cables needed to backup a hard disk at a rate of 5 megabytes per minute. Like the other products, the unit has a built-in fan,

MAC

PBI SOFTWARE

PBI has released two new products for Macintosh computers. DeskScene is a utility that lets users customize the computer's desktop screen by replacing the standard patterned background with any MacPaint picture, digitized or otherwise. The program can change the desktop image at random

DeskScene lets users customize Mac screens.

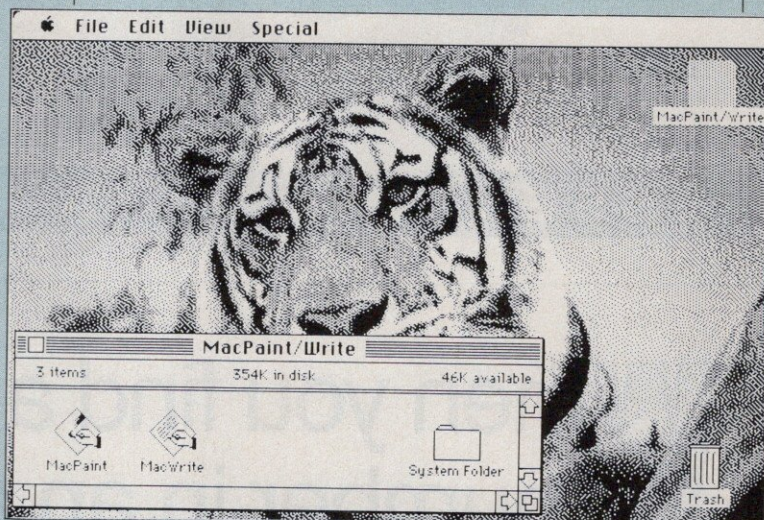

and an optional carrying case is available. (List Price: Macfast 20, \$1595; Macfast 30, \$1895; Macstor 10, \$2995; 10-megabyte cartridge, \$149; PL-20, \$1195; Macfast 20 Tape, \$1295; 20-megabyte CT-500 cartridge, \$29)

Requires: Macintosh,
512K RAM
Peripheral Land
3677 Enochs Street
Santa Clara, CA 95051
(408) 733-7600

CIRCLE READER SERVICE NO. 501

The Star NB-15 dot-matrix printer

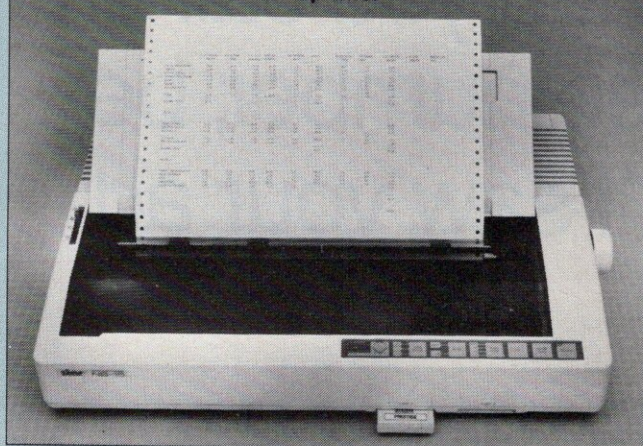

if users install more than one picture.

The second product, HFS Locator Plus, is a desk accessory that is compatible with all programs in the Macintosh Hierarchical File System format.

From within an application, users can locate files and folders in which they reside by date or by partial/matching name. After finding a file, HFS Locator Plus can show information or delete, rename, copy, or move it to another folder. The program can also create new folders.

(List Price: *DeskScene*, \$29.95; *HFS Locator Plus*, \$24.95)

Requires: Macintosh PBI Software, Inc. 1111 Triton Drive Foster City, CA 94404 (415) 379-8765

CIRCLE READER SERVICE NO. 502

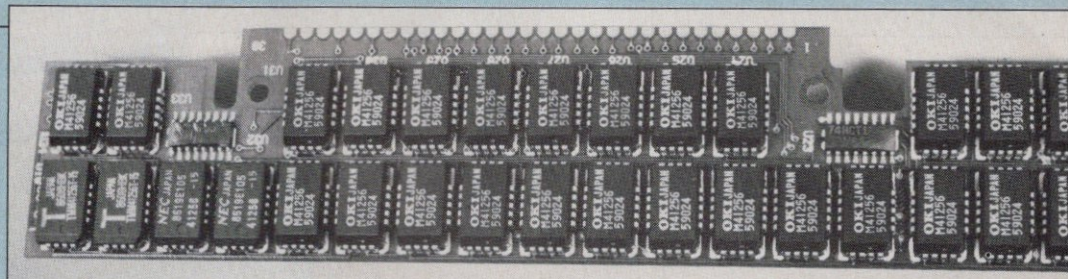

Two new MacMemory expansion boards let users expand the memory of the Mac and MacPlus by up to 4 megabytes.

DISK-DRIVE ALIGNMENT DEVICE

The Cascio Alignment Device, Model 525, enables users to perform a read/write alignment on most 5¼-inch disk drives in less than 20 minutes. The easy-to-use device offers a replacement for an oscilloscope and comes with a comprehensive manual, applicable software, and batteries. (List Price: \$129)

Requires: Apple II Cascio School of Computer Technology 2150 B Rheem Drive Pleasanton, CA 94566 (800) 422-7246 In CA (415) 462-7723

CIRCLE READER SERVICE NO. 503

The Cascio disk-drive alignment device for 5¼-inch disk drives



Peripheral Land has released several hard-disk drives for the Macintosh and Macintosh Plus.

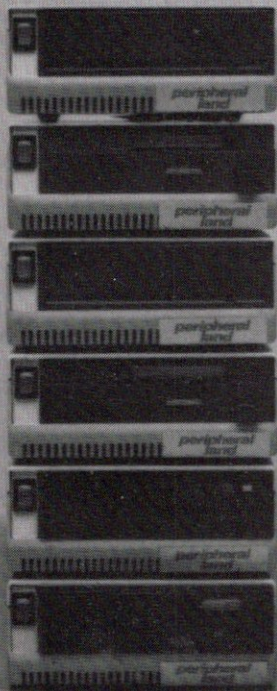

MACMEMORY EXPANSION BOARDS

MacMemory has released two products—TheMax2 and TheMaxPlus for the Macintosh and Macintosh Plus, respectively—that enable users to expand each computer's memory by up to 4 megabytes.

Both products comprise an expandable memory board the provides 2 megabytes of contiguous memory, and both are ready for expansion to 4 megabytes when users plug in 16 of the new megabit chips.

MacMemory or a dealer can install TheMax2 in a 128K or 512K Mac in exchange for the computer's motherboard; the product is also available as a do-it-yourself kit. TheMaxPlus is a set of modules that plug into the Macintosh Plus' expansion sockets.

Both products also come with free MaxRAM and MaxPrint software. MaxRAM automatically creates an adjustable 1.5-megabyte RAMdisk that runs ten times faster than a floppy disk. MaxPrint is a desk-accessory print spooler that spools both text and graphics easily. TheMaxPlus package also includes MaxChill, a quiet piezo fan. (List Price: TheMax2 installed, \$795 for 128K, \$645 for 512K; The-

Max2 kit, \$635 for 128K, \$565 for 512K; TheMaxPlus, \$499; MaxRAM and Max-Print, \$49.95)

Requires: Macintosh or Macintosh Plus, 128K or 512K RAM

MacMemory, Inc.
473 Macara Avenue
Suite 701
Sunnyvale, CA 94086
(408) 773-9922

CIRCLE READER SERVICE NO. 504

HARDWARE

MACDOUBLE D-D

Custom Computer Company (C.C.C.) is now offering an alteration service—MacDouble D-D—that converts a standard single-drive Macintosh computer into

a single unit with two internal disk drives. The company performs the alteration on the user's computer in two days.

C.C.C. can also install Mac Clean Air, a cooling system that pulls cool air through a dust filter, distributing it over the power-supply board. The system uses a low-speed, low-noise fan built into the top of the computer. Available as an alternative to this cooling system is Mac Hummingbird, a piezoelectric air mover that reinforces the computer's convection cooling and counteracts the buildup of hot spots. Both these products are also available as do-it-yourself kits. (List Price: disk-drive installa-

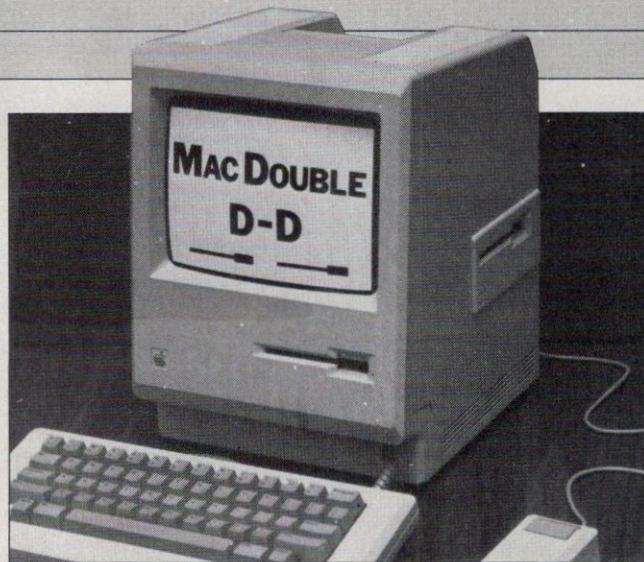

MacDouble D-D, a Macintosh with two built-in disk drives

tion, \$189.95; Mac Clean Air, \$129.95 installed, \$89.95 kit; Mac Hummingbird, \$99.95 installed, \$59.95 kit; complete Mac-Double D-D system including computer, two disk drives, and filter, \$1995)

Requires: Macintosh Custom Computer Company
3601 Parkview Lane
Suite 1-C
Irvine, CA 92715
(714) 786-3418

CIRCLE READER SERVICE NO. 505

LEGEND™ CARDS

**EXPAND
APPLEWORKS™**
on Apple II, II+, IIe,
IIc and Franklin

C'CARD™...1 MEG FOR IIc \$369

**FREE APPLEWORKS™ PATCH
256K to 1 MEGABYTE OF MEMORY
HIGH SPEED DISK EMULATION
USE MOUSE WITH APPLEWORKS™**

S'Card™ for the II, II+, IIe, III, Franklin

• Slot Independent • 1024K APPLEWORKS™ on Apple II, II+, IIe, Franklin

E'Card™ for the IIe

• 80 Column Display • RGB • Use Mouse with APPLEWORKS™

Send me info on:

C'Card (IIc)

E'Card (IIe)

S'Card (II/II+, IIe
Franklin)

Desktop Mouse

NAME _____ PHONE _____

ADDRESS _____

CITY _____ STATE _____ ZIP _____

LEGEND INDUSTRIES LTD. (800) 5-LEGEND or (313) 674-0953-2220 Scott Lake Rd-Pontiac, MI 48054
Legend, E'Card, S'Card, C'Card and Desktop Mouse are trademarks of Legend Industries, LTD. Apple and AppleWorks are trademarks of Apple Computer, Inc.

CIRCLE 287 ON READER SERVICE CARD

COMPLETE YOUR LIBRARY OF A+



Add to your A+ collection today. Make your personal library complete and authoritative with any issues you may be missing.

Copies are available for issues published during the last twelve months—be sure to specify the issues you want. If a particular issue is out of stock, your payment will be refunded promptly.

Back issues of A+ are priced at \$6.00 each, postpaid. Outside USA, \$7.00 each.

A+

Ziff-Davis, One Park Avenue, 4th Floor,
New York, NY 10016, K. Armstrong

Please send issues of A+ listed below:

Issue	Qty.	Unit Price	Total Price
Payment Enclosed			\$

Mr./Mrs./Ms. _____ (print full name)

Address _____

City/State/Zip _____



INTERFACE MODULES PRODUCTS

Interface Modules, Inc. (IMI) has introduced several new products for Apple computer users—the AP Series floppy-disk systems and 8064 and 80256 dual-function cards.

Designed for Macintosh and Macintosh Plus computers, the AP 3.5 floppy-disk drive features 800K of formatted memory, single push-button loading and auto-eject mechanism, low power consumption, and a soft loading function.

Other new releases in the AP Series are the AP 2, AP 2.5, and AP 2.5C for Apple II computers. These drives attach directly to any Apple II disk controller and feature a capacity of 143K, 256 bytes per sector, 16 sectors per track, and 35 tracks per disk.

For the Apple IIe, the 8064 and 80256 dual-function cards offer 64K and 256K RAM, respectively. Both cards also provide high-resolution, 80-column displays. (List Price: AP 3.5, \$349; AP 2, AP 2.5, \$199; AP 2.5C,

\$205; 8064, \$79; 80256, \$219)

Requires: Apple II, II Plus, IIe, IIc, Macintosh, or Macintosh Plus
Interface Modules, Inc.
2893 East La Palma
Anaheim, CA 92806
(714) 630-5350

CIRCLE READER SERVICE NO. 506



VIP CARD

The VIP (Very Intelligent Peripheral) Card is an Apple-compatible robotics controller card that can work either as a stand-alone controller or as a multifunction, intelligent peripheral card. It offers a 55C02 microprocessor, 16 I/O lines, 2 timer/counters, and 8K static RAM.

The card can also be expanded to include 48 I/O lines, 6 timer/counters, and 24K EPROM or static RAM. For robotics or control applications, users can develop programs on an Apple computer and load them directly into the VIP Card. They can then place the card into the robot or machine they wish to control. When used as a peripheral card, the VIP Card plugs into any Apple

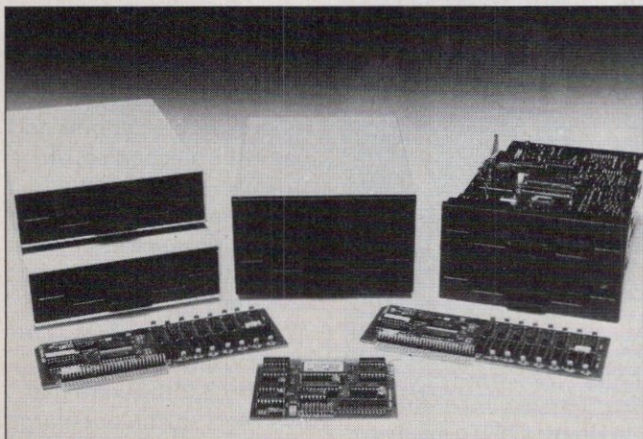

New products for Apple computer users from Interface Modules, Inc.

Attention Apple II+ Owners

If you own a Viewmaster 80, 80 column card you can run AppleWorks on your II+.

A II+ version of our powerful AppleWorks expand software is now available for only \$29.

This software allows any II+ with 64K or more memory and a Viewmaster 80 to run AppleWorks. And if you have a RamFactor or Apple compatible memory card you also get expanded records, word processor and more.

You'll receive this powerful software with our Viewmaster 80, the smart choice in 80 column cards, for only \$139.

AE APPLIED ENGINEERING

The Apple enhancement experts

(214) 241-6060

P.O. Box 798, Carrollton, TX 75006

HAVING TROUBLE REMEMBERING ALL THE COMMANDS FOR YOUR PROGRAMS?

YOU NEED

LEROY'S CHEATSHEET®

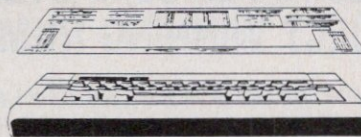

KEYBOARD OVERLAYS FOR THE

Apple® IIe & IIc

THE QUICK AND EASY SOFTWARE DOCUMENTATION

Forget about constantly referring back to the manual for operating commands. Discover all the "special" commands buried in the manuals. LEROY'S CHEATSHEETS® are sturdy plastic laminated help sheets designed for use with popular software, hardware and languages for APPLE IIe & IIc computers. Commands are grouped together for logical use. You learn and use your programs faster and easier.

IIe Cheatsheets are DIE CUT overlays designed to fit over the keyboard

only
\$5.95
each

IIc Cheatsheets are 7" x 10 3/4" reversible plastic laminated reference cards

With LEROY'S CHEATSHEETS® you will never have to hunt for a command again.

APPLEWORKS
APPLE WRITER II (ProDOS)
BASIC (Dos 3.3)
BASIC (PRODOS)
BLANKS (SET OF 3)
FLIGHT SIMULATOR II
FOR THE BEGINNER (DOS 3.3)
GRAPPLER +
LOGO (APPLE)
LOGO (TERRAPIN)
MULTIPLAN
PRACTICALC II
SCREENWRITER II
SPEEDSCRIPT
SUPERBASE
VISICALC

CIRCLE YOUR CHOICE

NEW

WORDSTAR
IMAGewriter
EPSON RX & FX 80
GEMINI 10X & 15X
OKIDATA 92 & 93

IIe (overlay) IIc (card)

QTY. _____ X \$ 5.95 = \$ _____

SHIPPING \$ 1.00*

* U.S. & CANADA \$1.00 (PA. TAX) _____

FOREIGN ORDERS \$3.00

CHECK, M.O., MC/VISA

U.S. FUNDS NO C.O.D. TOTAL \$ _____

MC/VISA # _____

EXPIRATION DATE _____

NAME _____

ADDRESS _____

CITY _____

STATE _____ ZIP _____

CHEATSHEET PRODUCTS INC.

P.O. Box 111368 Pgh., PA 15238

(412) 781-1551

a+ 6

PROF JONES
SUMMER/FALL 1986

ORDER LINE
(208) 342-6939

THOROUGHBRED
GREYHOUND
TROTTER

LOTTERY/LOTTO
FOOTBALL
BASKETBALL

OFFICE HOURS
M-F 8 AM - 5 PM
SAT 9 AM - 1 PM

(Mountain Standard Time)
FREE CATALOG

1940 W. STATE
BOISE, IDAHO 83702

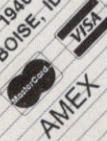

PROFESSIONAL HANDICAPPING SYSTEMS

PROFESSIONAL SERIES™ (Tho/Grey/Trot)
The all new Professional Series™ represents the most advanced handicapping software available.



Analysis Module™

Complete bet analysis highlights this basic Professional Series™ module. Full 50 tracks/kennels/etc. \$249.95

Factor Value/Multiple Regression Module™

Factor Value Weighting highlights this addition module™ \$149.95

Data Base Manager Module™

Automatic storage of last 11 races highlights this module. (\$99.95 with Factor Value Module) \$149.95

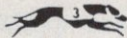

GOLD EDITION™

(Tho/Grey/Trot)
The classic Gold Edition™ from Prof. Jones offers flexibility, results, and ease of use.

Gold Edition™	\$159.95
Enhanced Gold Edition™	\$199.95
Limited Gold Edition™	\$299.95
Ultra Edition™	\$399.95

Professor Picks Football™

\$99.95; with win/loss power ratings \$149.95; Professional Series™ \$199.95

Expanded Lottery/Lotto Analysis

Lottery: 3-4 digits \$79.95; Lotto: max. of 99 digits \$99.95; Enhanced Lottery/ Lotto \$129.95

PC-3 Portable Computer (4k)

Choice of Thoroughbred/Greyhound/Trotter Gold Edition™ software. \$249.95

Model 100 Portable Computer (32k)

Choice of Thoroughbred/Greyhound/Trotter Gold Edition™ software with Master Bettor™ \$649.95

Handicapper's Bulletin Board now available
VHS Training Tapes now available

Terms: Free shipping all software. Add \$6.00 COD / \$6.00 UPS Blue / \$9.00 Out-of-country / ID residents add 5% / 3 weeks personal checks / cash price only add 2% Visa, MC, AMEX. Prices subject to change.

CIRCLE 132 ON READER SERVICE CARD

MILLIONAIRE LOTTERY WINNER USES APPLE COMPUTER TO PROJECT WINNING NUMBERS

This headline could be about you if you use the power of your home computer to your advantage in these big state lotteries.

THE LOTTO PROGRAM produces a powerful and complete probability study of the past winning lottery numbers with just single key presses from a main menu. The data generated includes 'hot' or 'cold' numbers, any trend or patterns, sums of digits, odd/even numbers and much more.

If you are really serious about winning, you'll forget random numbers and start making intelligent **PICKS**. It's designed to work in all states that have lotto games and Canada. This low cost program will have your friends asking "what should I play this week?", (but you don't have to tell them, do you).

You keep it up to date by simply adding the latest winner each week, and you can produce hard copies on any printer if you so desire. This program will cut those big odds down to size and may even pay for your computer (or your house).

Available for Apple (and most other computers) at only \$21.95 and the Super Macintosh version is only \$29.95 and comes with disk, hints and instructions.

Sold at selected software stores including 

(Dealer inquiries are invited.)

For fast mail order service write or call Soft-Byte at (513) 233-2200
We accept checks, M.O., or Visa/Master cards.

(Please add \$1.50 for shipping and handling - Thank you.)



SOFT-BYTE
P.O. Box 556 Forest Pk.
Dayton, Ohio 45405

CIRCLE 200 ON READER SERVICE CARD

Pipeline

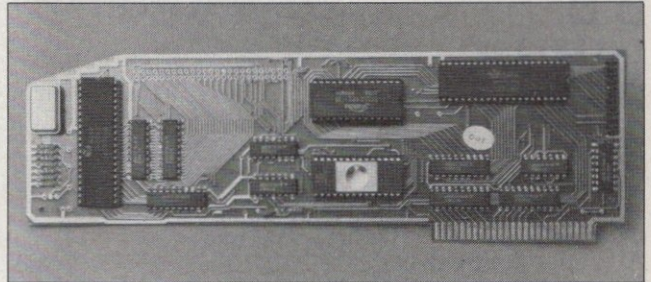

The VIP Card can work as a stand-alone controller or as a peripheral card for Apple II computers.

II expansion slot. (List Price: \$129)

Requires: Apple II, II Plus, or IIe
Bukowski Robotics

Company
1555 West University
Suite 105
Tempe, AZ 85281
(602) 967-6967

CIRCLE READER SERVICE NO. 507

SCSI board; a disk cache; a backup utility for incremental backup or mirror-image backup; print spooling; partition volumes; password protection; and a proprietary head-lifter mechanism. It can be connected to up to 32 Macintoshes and comes with a special version of Infosphere's Mac-Serve. (List Price: \$1495)

Requires: Macintosh, 512K RAM
Mirror Technologies
2209 Phelps Road
P.O. Box 304
Hugo, MN 55038
(612) 426-3276

CIRCLE READER SERVICE NO. 508

MAG

MAGNET 20 HARD-DISK DRIVE

Designed for the Macintosh Plus, the MagNet 20 is a single-user, 20-mega-byte, hard-disk drive that also provides built-in multiuser multitasking. The drive includes an internally mounted, three-chip

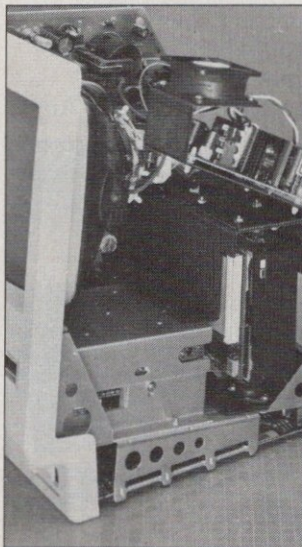

The MagNet 20 is a multiuser, internal hard-disk drive for the Macintosh.

MAG

MACTABLET

Summagraphics Corporation has released a new version of its graphics tablet MacTablet. The new tablet provides an active work area of 12 x 12 inches. The tablet connects to the computer's modem or printer port and has a tilt mechanism so that users can adjust it to a comfortable position. Users can produce artwork freehand or can trace drawings through material up to 1/2-inch thick. The tablet comes with new Version 3.0 software that lets users shrink or enlarge drawings; it also offers a Viewport feature with

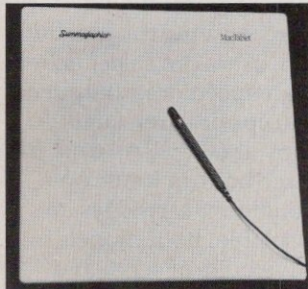

Summagraphics' MacTablet

which users can control the size and location of the tablet's active area. (List Price: \$549)

Requires: Macintosh
Summagraphics Corporation
777 State Street Extension
Fairfield, CT 06430
(203) 384-1344

CIRCLE READER SERVICE NO. 509

**TRANSWARP
ACCELERATOR
CARD**

The Transwarp, an accelerator card that speeds up both the main and auxiliary memory of an Apple II computer, is now available from Applied Engineering. The card enables software to run up to three and a half times faster, works with all Apple II Plus and IIe software, and is compatible with all standard peripheral cards. To disable it, users can press the Escape key. (List

Price: \$279)
Requires: Apple II, II Plus, or IIe
Applied Engineering
P.O. Box 798
Carrollton, TX 75006
(214) 241-6060
CIRCLE READER SERVICE NO. 510

**SP-1000 SERIES
PRINTERS**

Hattori Seiko Computer Peripherals has introduced the SP-1000 series of dot matrix printers. The SP-1000AS offers a standard RS-232 serial interface, the SP-1000AP is compatible with Apple IIc and Macintosh computers, and the SP-1000A has a non-computer-specific character set that makes it compatible with a variety of computers. All SP-1000 printers feature standard items such as bidirectional printing with logic seeking, adjustable tractor and friction feed, a variety of print character sets, automatic paper loading, and right/left margin-set functions. (List Price: \$299 each)

Requires: Apple IIe, IIc, or Macintosh
Hattori Seiko Computer Peripherals
1111 Macarthur Blvd.
Mahwah, NJ 07430
(201) 529-5730

CIRCLE READER SERVICE NO. 511

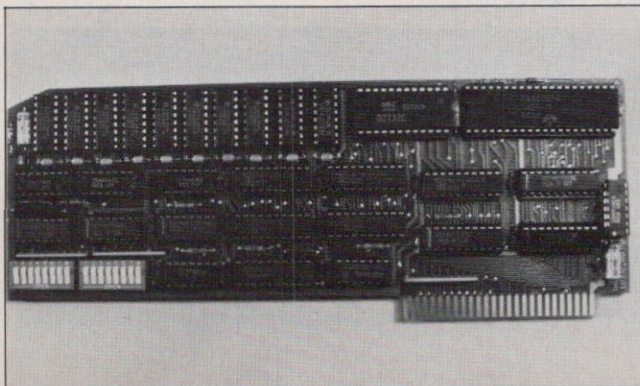

The Transwarp accelerator card

TRY THIS ON FOR SIZE.

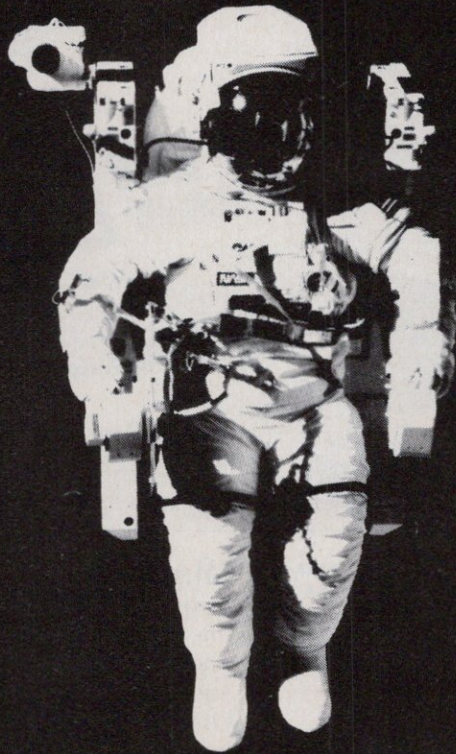

At the United States Space Camp, you'll have to. It's required attire, you see, in your training for a Space Shuttle mission. You'll be piloting a shuttle simulator, working under weightless conditions, doing what most people only see on the six o'clock news.

PROJECT: SPACE STATION

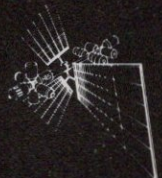

Our space station construction software, can get you to Space Camp for the time of your life. You'll need to get your hands on it and build us your best station.

We'd like to see you in this suit. Soon. See your favorite software dealer for a Space Camp Scholarship booklet and construction guidelines, or write to us at the address below.

HesWare

P.O. Box 631-SCS
So. San Francisco, CA 94080
(415) 871-0570

CIRCLE 147 ON READER SERVICE CARD



Finger Print LetterWriter is an upgrade kit that enables Epson FX printers to produce near-letter quality print.



FINGER PRINT LETTERWRITER NLQ UPGRADE KIT

An upgrade kit that provides users of Epson FX printers with near-letter-quality (NLQ) print is now available. Finger Print LetterWriter is a kit of replacement ROMs that plugs into original and + series FX-80 and FX-100 printers. With the NLQ upgrade kit, users can select the NLQ mode either via software or from the printer panel's buttons. In the Apple mode, the FX printer can accept graphics and control codes in the Apple printer format for use with Macintosh or Apple IIc programs such as MousePaint. (List Price: \$79.95)

Requires: Apple IIc or Macintosh
Dresselhaus Computer Products
837 East Alost Avenue
Glendora, CA 91740
(818) 914-5831

CIRCLE READER SERVICE NO. 592

IMAGEWARE

Two products in a new line of ImageWriter II peripherals called ImageWare are now available from Orange Micro. ImageMate is an intelligent module that fits inside the ImageWriter II and provides compatibility with most non-Apple computers. The module also offers a standard print buffer of 64K, expandable to 128K. The buffer contains Copy and Clear features for greater flexibility when you print documents.

Designed for Apple computers, the ImageBuffer also installs inside the ImageWriter printer. The board offers all the buffering features of ImageMate, and the buffer

commands can be disabled easily with an on-board switch. (List Price: ImageMate, \$129; ImageBuffer, \$99)

Requires: ImageWriter II Orange Micro, Inc.
1400 N. Lakeview Avenue
Anaheim, CA 92807
(714) 779-2772

CIRCLE READER SERVICE NO. 593

EPSON LQ-800, LQ-1000 PRINTERS

Epson America has introduced two new dot-matrix printers—the 80-column LQ-800 and the 136-column LQ-1000—featuring a special 24-pin printhead that can create high-resolution characters in a single pass. The printers also offer logic-seeking bidirectional printing, 96 ASCII and 13 international character sets, and proportion-

al-space printing. By pressing a front-panel button, users can select either high-speed draft output at 180 cps or letter-quality copy at 60 cps. As well as three built-in fonts, optional font cartridges are available. Both models have built-in serial and parallel interfaces, friction paper feed, and a 7K buffer; optional tractor and cut-sheet feeders are also available. (List Price: LQ-800, \$799; LQ-800 tractor feeder, \$49.95; LQ-800 cut-sheet feeder, \$129.95; LQ-1000, \$995; LQ-1000 tractor feeder, \$59.95; LQ-1000 cut-sheet feeder, \$169.95)

Epson America, Inc.
2780 Lomita Blvd.
Torrance, CA 90505
(800) 421-5426
in CA (213) 539-9140

CIRCLE READER SERVICE NO. 594



The ImageMate module lets non-Apple computers work with the ImageWriter II.

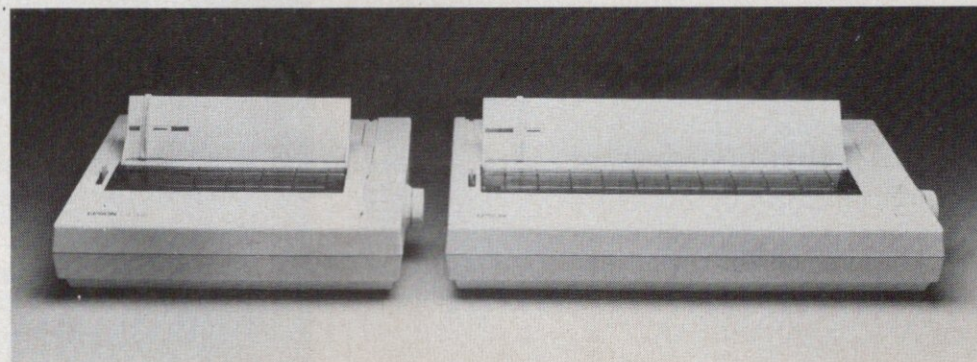

Epson America's LQ-800 and wide-carriage LQ-1000 high-resolution dot-matrix printers

ACCESSORIES

ERGOTRON PEDESTAL BASE

The Ergotron Pedestal Base is designed specifically for Apple's IIc Color Monitor. The base elevates the monitor by approximately four inches and provides variable vertical and horizontal adjustment of the viewing screen to minimize glare and to ease eye, neck, and back strain. Its metal top plate eliminates any RFI interference or disk problems associated with using the IIc and the monitor. (List Price: \$89.95; volume discount available)

Requires: Apple IIc Color Monitor

Ergotron, Inc.
1621 East 79th Street
Suite C-133
Minneapolis, MN 55420
(800) 328-9839
In MN (612) 854-9116

CIRCLE READER SERVICE NO. 512

DATASAFE CABLES

Monster Cable's new line of high-precision computer cables, the DataSafe Series, consists of ten quality cables that can connect all popular computers to printers and modems. The cables have heavy shielding made of dual-sided mylar foil and high-density braids; they are color-coordinated to complement all Apple models. Each cable terminates with the firm's custom-designed DB-9, DB-25, or 90° Centronics hoods. (List Price: \$40-\$60)

Monster Cable
101 Townsend Street
San Francisco, CA 94107
(415) 777-1355
CIRCLE READER SERVICE NO. 513

PLOTTER PEN ADAPTER

L.J. Stafy Design Services' plotter-pen adapter is designed to mate Pentel plotter pens with Houston

Instrument DMP series plotters; it also works with plotters from various other manufacturers. The adapter, which is made of black Delrin plastic and comes with an Allen wrench, works with both ceramic-tip and roller-tip pens. Pens are available from other suppliers in various sizes and are packaged as disposable sealed units. They can maintain a uniform line width at plotting speeds of 10 to 14 inches per second. (List Price: \$6.49)

Requires: Pentel plotter pen, plotter
L.J. Stafy Design Services
1439 Virmay Drive
Gilbertsville, PA 19525
(215) 341-6438
eves. (215) 367-7052

CIRCLE READER SERVICE NO. 514

CALC/PAD

Designed for executives who wish to pass on template designs to subordinates who develop actual spreadsheets at the key-

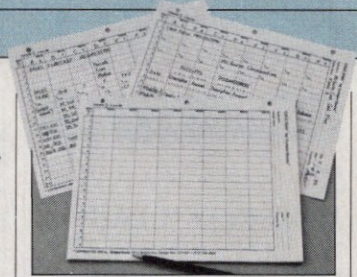

The CALC/PAD spreadsheet organizer pad

board, CALC/PAD is a spreadsheet organizer pad that provides a series of columns and rows in which users can write exact templates specifications. Each CALC/PAD consists of 50 individual layout forms produced on erasable green paper that has holes punched for placement in a three-ring binder. Each form has 20 rows and 8 columns, providing spaces for penciling in required text, values, and formulas. (List Price: \$5.95)

COMPU-QUOTE
6914 Berquist Avenue
Canoga Park, CA 91307
(818) 348-3662

CIRCLE READER SERVICE NO. 515

Zimco International

85-39 213th Street, Queens Village, NY 11427

(800) 227-6647
NY Call (718) 479-7888

DRIVES	
Bernoulli Box (Mac)	\$1450
Corvus Hard Drive	call
Disk Drive — One Year Warranty	\$ 155
Disk Drive Controller (Apple)	\$ 30
Habba (Mac)	\$ 279
Quark 10 Meg Hard Drive (Apple)	\$ 999
Quark 20 Meg Hard Drive (Apple)	\$1350
Tymac 3.5" Drive	\$279

PRINTERS:	
Brother HR-15	\$335
Citizen 120D	\$179
Citizen MSP 10	\$240
Daisywriter 2000	\$735
Epson FX-85	\$359
Epson LX-90 w/pic	\$245
Epson 286	\$499
Epson AP-80	\$280
NEC Pinwriter P2*	\$425
Okimate 20*	\$125
Okidata 192p	\$339
Okidata 193	\$455
Qume Letter Pro 20	\$430
Qume Sprint 1400*	\$899
Panasonic KXP-1091	\$229
Panasonic KXP-1092	\$330
Panasonic KXP-1592	\$460
Silver Reed EXP-800	\$649
Star SG-10	\$219

*requires interface

SUPPLIES:	
Centronics Parallel Cable	\$21
Disk Notcher	\$ 5
Laser Edge 20 lb. Paper (1000)	\$19
Maxell MDI	\$15
Maxell MDII	\$19
RS232 Cable	\$21
64K Chips (8)	\$14

SOFTWARE	
Beagle Bros. Mini-Pix Disk #1	\$17
Fontrix	\$59
Graphics Department	\$66
Newsroom	\$33
Newsroom Clip Art Collection	\$16
Print Shop	\$28
Print Shop Graphics Libraries	\$15
Print Shop Companion	\$23
Sensible Grammar	\$52
Sensible Speller Pro-Dos	\$66
Typing Tutor III	\$31

MONITORS	
Amdek 300 Green	\$116
Amdek 310 IBM Amber	\$142
Amdek 600 Color RGB	\$375
Amdek 722 Color	\$489
NEC Amber	\$ 89
Panasonic DTH-103	\$389
Princeton HX-12 RGB	\$430
Princeton MAX-12 Amber	\$168
Sakata SC-100 Color	\$149

Applied Eng. Ram
Works II 512k
\$199
Half Height Disk Drive
Apple II Series
\$125

MODEMS	
Anchor Express 300/1200	\$239
Anchor Volksmodem 300	\$ 49
Hayes Micromodem IIe	\$128
Hayes Smartmodem 300 (IIc)	\$152
Hayes Smartmodem 1200	\$359
Hayes Smartmodem 1200B	\$325
Hayes 2400	\$559
Novation Applecat II	\$187
Novation Applecat 212 system	\$353
Novation Applecat 212 upgrade	\$214
Prometheus Pro-Modem	\$290
Prometheus Pro-Modem 1200A	\$265
1200 Baud (Hayes)	\$250
U.S. Robotics 1200	\$235
U.S. Robotics 2400	\$440

APPLE ACCESSORIES:

A+ Mouse (IIc, Mac)	\$ 65
Applied Eng. Music Synthesizer	\$120
Applied Eng. Ram Works II 256k	\$189
Applied Eng. Ram Works I meg	call
Applied Eng. RGB Option	\$ 95
Applied Eng. Timemaster	\$ 95
Applied Eng. Viewmaster	\$345
Applied Eng. ZRAM w/512k	\$149
AST Multi I/O (IIe)	\$ 33
CH Mach III Joystick	\$ 24
Coolingfan	\$ 60
80 Column Card (II+)	\$ 20
80 Column Card w/Softswitch	\$ 70
Ext. 80 Column Card (64k, I/IIe)	\$ 55
Graphics Printer Card	\$ 28
Pico Joystick	\$ 33
Kensington System Saver	\$ 33
Koala Pad Plus	\$ 33
Kraft Joystick	call
Mockingboard A,B,C,D	call
O.M. Bufferboard for Grappler*	\$ 60
O.M. Grappler *	\$ 73
O.M. Grappler +, Buffered	\$133
O.M. Grappler +, Serial	\$ 75
O.M. Grappler +, IIc	\$ 75
O.M. Hotlink	\$ 45
Power Strip	\$ 13
Printer Interface Parallel	\$ 40
Quadram Clock Calendar	\$ 60
16k Ram Card	\$ 35
Super Serial Card	\$ 69
Thunderclock	\$104
Video7 Slot 7	\$100

FREE SHIPPING
(on prepaid orders)

Terms: Any order may be returned within 30 days for a full credit subject to a 15% restocking fee. All prices reflect a 3% cash discount. NYS residents add 6.25% sales tax. Personal/corporate checks allow 2 weeks to clear. All returns require a return authorization number. Computer sales are not subject to free shipping. MC and VISA do not qualify as prepaid orders. Purchase orders are accepted. Prices are subject to change without notice. We are not responsible for typographical errors.

HARD/SOFTWARE

MAC

MACSPEECH LAB

The latest addition to GW Instruments' MacADIOS product line, MacSpeech Lab turns the Macintosh computer into a powerful speech-analysis workstation for studying human speech and testing the speech impaired. The workstation and components consist of MacSpeech Lab software, MacADIOS hardware, and a Macintosh computer.

MacADIOS System I hardware is a complete hardware and software data-acquisition system that features four 12-bit analog voltage outputs, eight 12-bit analog voltage inputs, 16 digital inputs, 16 digital outputs, a timer, and a programmable clock. Software that comes with the unit includes 5 Instruments, MacADIOS Manager, XY MaCorder, 53 compiled functions for easy control from Microsoft BASIC or Manx Aztec C, calibration and hardware test programs, and example BASIC programs.

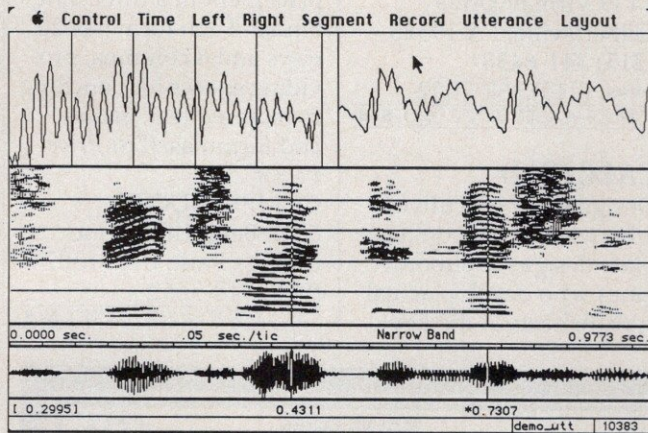

The MacSpeech Lab turns the Mac into a powerful speech-analysis workstation for studying and testing human speech.

When used with MacSpeech Lab software, the MacADIOS hardware records words and phrases digitally at sample rates up to 20,000 samples per second. Users can use the mouse to select time and frequency representations of speech at different positions. They can also amplify, offset, normalize, save to disk, delete, play, and zero in on segments within utterances. The system produces sound spectrograms that show the progression of frequency spectra with time and draws pitch plots to show the variation of fundamental frequency within an utterance. (List Price: MacADIOS, \$2500; MacSpeech Lab software, \$300; demo disk, \$10)

Requires: Macintosh
GW Instruments
P.O. Box 547
Cambridge, MA 02142
(617) 577-1524

CIRCLE READER SERVICE NO. 516

INTERBRIDGE

InterBridge provides both local and remote bridge capabilities for expanding AppleTalk networks. Us-

ing the bridge, an AppleTalk-compatible computer on one network can access other AppleTalk-compatible computers, file servers, LaserWriter printers, and other output devices on another network. As a local bridge, the product can link two closely located AppleTalk networks; as a remote bridge, two networks, each equipped with an InterBridge and a Hayes Smartmodem 2400, can access each other through either dial-up or leased telephone lines. The product can handle one local bridge and two remote bridges simultaneously.

Also provided with each unit is the InterBridge Manager Software, which provides a variety of configuration and management options so that users can tailor InterBridge to fit their needs. (List Price: \$799)

Requires: AppleTalk
Hayes Microcomputer Products, Inc.
P.O. Box 105203
Atlanta, GA 30348
(404) 441-1617

CIRCLE READER SERVICE NO. 517

Macintosh Aficionados

A+ would appreciate receiving any tips, hints, shortcuts, or suggestions that you have for using the Macintosh computer. We would like to publish these pearls in our MacTips feature in our Macintosh section. You'll receive credit in the magazine, and we'll pay \$50 for each MacTip that we use. Send your tips to:

MacTips
A+ Magazine
ATTN: Chip Carman
11 Davis Drive
Belmont, CA 94002

100% APPLE COMPATIBLE



**If you own or work with a Macintosh or Apple II series computer,
you need A+ Magazine.**

Every month you'll find in-depth tutorials that help you take your system into more complex and comprehensive business and home applications... discover tips and the know-how to maximize your computer investment... and keep up-to-date on the latest technological breakthroughs for Apple IIs and Macs



—the only magazine Apple II and Macintosh users will ever need!

Subscribe today and save up to 50%! Call toll-free, 1-800-852-5200 or use the attached order card and tell us how much you want to save on A+!

1 year only \$19.97—Save 44%

2 years only \$35.40—Save 50%

Savings based on annual newsstand price of \$35.40.

4Z346

SOFTWARE

KEYBOARD CONTROLLER SEQUENCER

The Keyboard Controller Sequencer is designed to run on unexpanded computers using a Passport-compatible MIDI interface and supports the Passport sync-to-tape facility. The program enables users to operate their system as a 16-track tape recorder capable of recording and playing back on any or all of the 16 MIDI channels. It includes a complete editing system and a flexible set of options for structuring music. Users can record sequences in real time from the synthesizer keyboard, can enter sequences one at a time from the computer keyboard, or can enter sequences of evenly spaced notes from the synthesizer keyboard using the Step-Time feature. Other features include the abilities to merge and print sequences and to move, copy, transpose, invert, auto-correct, and time-reverse part or all of any sequences. (List Price: \$175)

Requires: Apple II Plus or IIe, Passport-compatible interface

Dr. T's Music Software
66 Louise Road
Chestnut Hill, MA 02167
(617) 244-6954

CIRCLE READER SERVICE NO. 518

FOSCIL FDOS

A disk-operating system for Apple IIe and IIc computers, FDOS provides five extra tracks for each disk made in its format

and gives users 20K of the upper 64K on a 128K system. The program is easy-to-use and comes with a BASIC interpreter. It works with DOS 3.3 commands and has a setup similar to that of MS-DOS. (List Price: \$29.95)

Requires: Apple IIe or IIc, 128K RAM, 80-column display, Mousertext Foscil Labs/DataCom Media

406 East 73rd Street
New York, NY 10021

CIRCLE READER SERVICE NO. 519

COMMWORKS

Compatible with most modems for Apple II computers, CommWorks is a telecommunications software package that has an AppleWorks-type interface with on-line help. To make the software easy to use, it incorporates four special features: CommWorks Communications Files, which allow users to define and save often-used communications parameters and commands for terminal sessions; an Automatic Log-on facility, which lets users define a set of macros that they can instruct CommWorks to execute by using a single keystroke; CommWorks Macros, which allow users to define up to 18 separate sets of macros and keep them in a library; and CommWorks Text Editors, with which users can create or modify their ProDOS documents. (List Price: \$95)

Requires: Apple IIe or IIc, ProDOS, modem PBI Software, Inc.
1111 Triton Drive
Foster City, CA 94404
(415) 349-8675

CIRCLE READER SERVICE NO. 520

BEACH-HEAD GAMES

Beach-Head, an action/strategy game, and its sequel Beach-Head II are now available in versions for Apple computers.

Beach-Head's setting is a war scenario in which players move through torpedo-infested waters and take part in a full-scale air assault, sea battle, and land invasion over an obstacle-laden beach. In the final conflict at the fortress of Khun Lin, players must eliminate ten gun turrets while being bombarded by enemy mortar.

Designed for one or two players, the games feature high-resolution graphics, sound effects, and multiple scrolling screens. Beach-Head II, subtitled The Dictator Strikes Back, also features rotoscopic animation techniques. Both games have a Demonstration mode that allows players to practice individual phases of the games and offer the ability to save high scores to disk. (List Price: \$34.95 each)

Requires: Apple II Plus, IIe, or IIc, 48K RAM; one disk drive

Access Software, Inc.

2561 S. 1560 West
Woods Cross, UT 84087
(801) 298-9077

CIRCLE READER SERVICE NO. 590

RECORD HOLDER

Record Holder is a full-function data-management system for Macintosh computers. All data fields are variable in length, with field size limited only by computer memory space. Besides text fields, the software allows numeric, date, money, statistical and computed fields. Other features of Record Holder include a separate Table of Contents window that lists all records in a file, form-oriented Display and Report functions, and a Preview function that enables you to view reports on-screen before you print them. Reports can be up to 16 inches wide and can include page headers and summary statistics. In addition, the number of sort levels for reporting is unlimited. (List Price: \$49.95)

Requires: Macintosh Software Discoveries, Inc.
99 Crestwood Road
Tolland, CN 06084
(203) 872-1024

CIRCLE READER SERVICE NO. 591

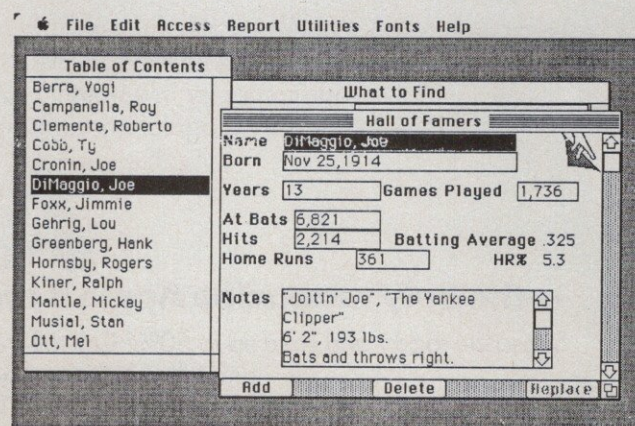

A sample screen from Record Holder

MAC

PROFIT STALKER II

Profit Stalker II is an enlarged and revised version of a technical analysis program designed for personal investors, traders, and brokers. The program provides Macintosh users with integrated database, charting, and terminal-emulation features that they can use to analyze and chart the movement of stock and commodity prices. With a modem and a subscription to an on-line database service, users can download price data directly into Profit Stalker's database. Charting tools include daily bar charts, volume, open interest, on-balance volume, moving averages, relative strength, oscillators, momentum, accumulation-distribution, and point-and-figure charts. Users can set many of the chart parameters and can also track spreads and draw trend lines. (List Price: \$250)

Requires: Macintosh, 512K RAM
 Button•down Software
 P.O. Box 19493
 San Diego, CA 92119
 (619) 463-7474

CIRCLE READER SERVICE NO. 521

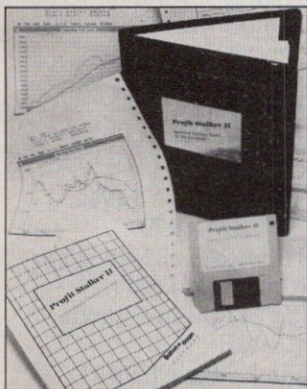

Profit Stalker II, an analysis program for stock or commodities traders

MAC

MACPALETTE

MacPalette allows users to produce full-color text and graphics when they use a Macintosh computer with the ImageWriter II. Users can design an almost infinite number of color patterns that they can assign to any selected area of a drawing. A Text Color option gives a choice of 32 type styles that can be printed in any one of the seven basic colors. (List Price: \$69)

Requires: Macintosh, ImageWriter II
 Microspot
 9 High Street
 Lenham, Maidstone
 Kent ME17 2QD, England
 (0622) 858753

CIRCLE READER SERVICE NO. 522

MAC

MACSPEC

MacSpec is a specialized word processor/editor for the development of specifications, proposals, and technical papers. As well as having standard word-processing features, MacSpec performs the following functions automatically—section numbering, section indentation, and production of tables of contents with section page numbers. It can also produce a new table of contents when users move sections and can automatically generate new section numbers when sections are cut and pasted. (List Price: \$199.95)

Requires: Macintosh or Macintosh Plus
 LM Software
 P.O. Box 93
 Belmont, CA 94002-0093
 (415) 594-0627

CIRCLE READER SERVICE NO. 523

Viewmaster 80,TM the sharpest 80 column card of them all.

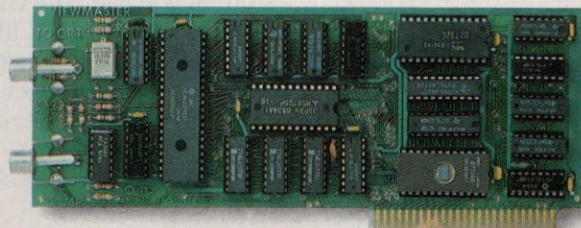

	BUS IN SWITCH	SOFT KEY SUPPORT	LOW POWER DESIGN	80 COLUMN HOME	7 x 9 DOT MATRIX	LIGHT PEN INPUTS	80 COLUMN OVERRIDE	INVERSE CHARACTERS
VIEWMASTER 80	✓	✓	✓	✓	✓	✓	✓	✓
SUPRTERM				✓			✓	
WIZARD 80					✓		✓	✓
VISION 80	✓	✓			✓			
OMNIVISION		✓					✓	✓
VIEWMAX 80	✓	✓		✓				
SMARTERM	✓	✓				✓	✓	
VIDEOTERM		✓	✓		✓	✓		✓

Now, get great resolution and total software compatibility for your Apple II[®] or II+[®]

One look at the chart will give you some of the reasons there's only one smart choice in 80 column cards for your Apple. But the real secret to Viewmaster 80's success is something even better: Total compatibility.

The Viewmaster 80 works with all 80 column applications, including DOS 3.3, PRO-DOS, CP/M, Pascal, WordStar, Format II, Easywriter, Applewriter II, Supertext 80, Zardax, Apple PI, Letter Perfect, dBASE II, Visicalc, Multiplan, and *hundreds* of others.

And the Viewmaster 80 delivers a super sharp, state-of-the-art display with a 7x9 character matrix for clear, easily readable characters. Here are just a few of the powerful features the Viewmaster 80 delivers for a great price (\$139):

- 80 Characters by 24 lines
- Fully compatible with all Apple languages and software
- Super sharp 7x9 character matrix with true descenders
- Highest compatibility with existing 80 column software
- Power and input connector for light pen
- Very low power consumption
- High speed (18 MHz) scroll rate
- Upper and lower case characters with true descenders, both inverse and normal; all on-screen editing functions are supported
- User-definable cursor shape
- Compatible with Apple II, II+ and IIe
- Five year warranty

Call to order today, 9 a.m. to 11 p.m. seven days, or send check or money order to Applied Engineering. MasterCard, VISA and C.O.D. welcome. Texas residents add 5½% sales tax. Add \$10.00 outside U.S.A.

AE Applied Engineering
 P.O. Box 798, Carrollton, TX 75006
 (214) 241-6060

MAC SERIES **FINGERTIPS**

Fingertips is a collection of desktop accessories that work under DOS or ProDOS on Apple II computers. The package can either be used on its own, or it can run behind other programs on 128K IIe or IIc systems. Desktop accessories include a full-function business, scientific, and programmers' calculator; calendar; appointment planner; notepad; card file; phone directory; telecommunications package; and instant access to DOS or ProDOS. Additional features include the ability to print any function and any of the user's screen.

Also available is Programmer's Fingertips, a collection of utilities, charts, and tools designed for programmers. As well as having the Fingertips notepad, calendar, and calculator, this package includes a screen-dump utility, Applesoft tools, machine-language tools, disk tools, and a hexadecimal calculator. (List Price: \$39.95 each)

Requires: Apple II, II Plus, IIe, or IIc; 48K RAM; DOS or ProDOS
Fingertips
830 N. Riverside Drive
Suite 201
Renton, WA 98055
(800) 628-2828, ext. 543
(206) 226-3216

CIRCLE READER SERVICE NO. 527

MAC **HD BACK-UP**

Designed for Macintosh computers, HD Back-Up is a backup utility that can copy all data from hard-disk drives and other peripherals to floppy disks.

The utility has four options: Global, Incremental, Restore All Files, and Restore Single File. The Global option restores all files to sets of disks. The Incremental option copies everything changed after a global change. The Restore All Files option enables users to put all information back on hard disks, and the Restore Sin-

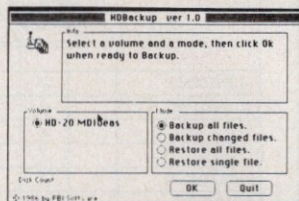

A screen from HD BACKUP

gle File option copies a single file from a backup disk to a hard disk. The program also has a Disk Count gauge that tells users how many floppy disks they will need in order to make a global backup. (List Price: \$49.95)

Requires: Macintosh, or Macintosh XL under MacWorks
PBI Software, Inc.
1111 Triton Drive
Foster City, CA 94404
(415) 379-8765

CIRCLE READER SERVICE NO. 528

MAC **MACSAFE**

Macintosh users can protect files from casual scrutiny by placing them in a password-protected safe area of a disk by using MacSafe, a new product from Kent Marsh Ltd. Each safe area on a disk also has a secret compartment for especially sensitive files, providing an extra level of protection. MacSafe also allows users to encrypt files using the American National Stan-

dard for Data Encryption. Because this standard is used by the U.S. Government, MacSafe cannot be exported, but an international version will be available soon. (List Price: \$69.95)

Requires: Macintosh
Kent Marsh Ltd., Inc.
1200 Post Oak Blvd.
Suite 210
Houston, TX 77056
(713) 623-8618

CIRCLE READER SERVICE NO. 529

MAC SERIES **MINDSCAPE SOFTWARE**

Four new software products are available from Mindscape. Developed in cooperation with Dr. Max Luscher, author of the book *The Luscher Color Test*, *The Luscher Profile* helps users reveal their true personality by drawing psychological profiles based on their reactions to colors and shapes. In *The American Challenge: A Sailing Simulation*, one or two players compete with the top eight American sailors to win a trip to Perth, Australia, where the next America's Cup race will be held in 1987.

The other two programs are interactive text adventure games. Based on the book by Dick Francis, *Dick Francis' High Stakes* puts the player in the role of a wealthy English racehorse owner who must foil a sinister plot and in the process gambles money, reputation, and life. In *James Bond 007 Goldfinger*, the player must prevent a scheme that threatens Fort Knox and the entire U.S. economy. (List Price: \$39.95 each)

Requires: Apple II, II Plus, IIe, or IIc; 64K RAM;

James Bond also Macintosh, 512K RAM
Mindscape, Inc.
3444 Dundee Road
Northbrook, IL 60062
(312) 480-7667

CIRCLE READER SERVICE NO. 530

MAC **TOPMAIL**

TopMail is an electronic-mail service that operates as a desk accessory that can work alongside any Macintosh application. Not limited to one-to-one message handling, TopMail can dispatch any length of message to any number of AppleTalk network users at one time. Once a message has been sent, the receiver is alerted automatically. If the receiver has logged off, the

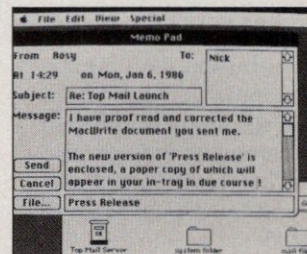

A sample screen from TopMail

mail server stores the message and dispatches it as soon as the receiver logs back on. The package uses no special commands and is thus easy to use. (List Price: \$250)

Requires: Macintosh, AppleTalk
Icon Review
P.O. Box 2566
Monterey, CA 93942
(800) 824-8175
In CA (800) 228-8910 or
Topexpress Ltd.
13/14 Round Church
Street
Cambridge CB5 8AD
England
(0223 355427)

CIRCLE READER SERVICE NO. 531

MAC

MACTABLET SOFTWARE, VERSION 3.0

Summagraphics Corporation is now shipping Version 3.0 software with its MacTablet graphics tablet for the Macintosh. The new software lets users shrink or enlarge drawings, scaling them down from the 1:1 ratio to a 1:0.5 ratio or up to a 1:1.15 ratio, as they are traced for input into the computer. The software also has a Viewport feature that allows users to control the size and location of the tablet's active area. The MacTablet is compatible with all Macintosh software and connects to the computer's modem or printer port. Version 3.0 is free for all current MacTablet owners.

Requires: Macintosh, MacTablet Summagraphics Corporation
777 State Street Extension
Fairfield, CT 06430
(203) 384-1344

CIRCLE READER SERVICE NO. 524

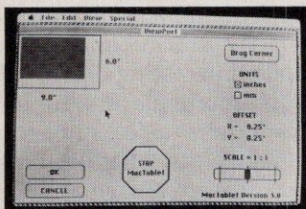

A screen from MacTablet Version 3.0 software

II SERIES

BIO*CELL

Intended for anyone in seventh grade and up who is interested in biology, Bio*Cell presents an introduction to the biology of cells. The easy-to-use program illustrates the major cell structures for plants and animals; explains the

function of each organelle, and provides a survey of the various types of cells that make up plants and animals. Other features include testing of students' knowledge of cell structure; an introduction to genetics and the structure of DNA and how it codes genetic information; and an on-screen glossary of biological terms relating to cells. (List Price: \$29.95)

Requires: Apple II Plus, IIe, or IIc; 64K RAM; one disk drive
Zephyr Services
306 South Homewood Avenue
Pittsburgh, PA 15208
(412) 247-5915

CIRCLE READER SERVICE NO. 525

MAC

STRU-PLAN

The Stru-Plan Steel Design Package is an interactive design tool for structural engineers. The package provides a set of Multiplan templates that assist in the design of the major structural elements of steel buildings. Available templates are Beams, Columns, Footings, Baseplates, Slabs & Girts, Basement Walls, and Roof and Floor Joists. The package also has forms for estimating construction costs and standard guide specifications. Output is in the format of 8 1/2 x 11-inch calculation sheets that include all information necessary to document designs. (List Price: \$349)

Requires: Macintosh, 128K RAM, one disk drive, Multiplan, MacWrite
Benchmark Software, Inc.
824 Cotswold Road
Somerdale, NJ 08083
(609) 784-6070

CIRCLE READER SERVICE NO. 526

Timemaster H.O.™, the only clock that displays time and date on AppleWorks™ screens and files.

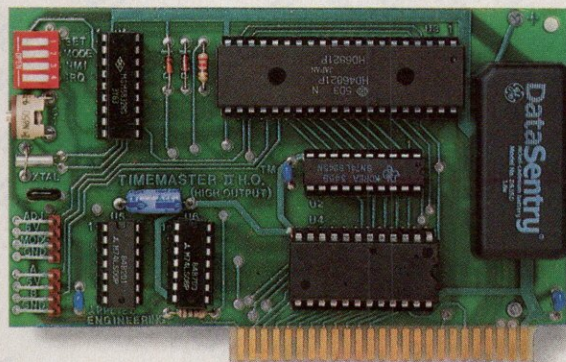

Now, get all the features of all the competition combined!

It's the smart way to put the time and date on your Apple II+® or IIe®. Because only the Timemaster H.O. packs ALL the features of all the competition *combined*, including leap year, year (not just in PRO-DOS), month, date, day of week, hours, minutes, seconds and milliseconds. It's totally PRO-DOS, DOS 3.3, PASCAL and CPM compatible. And of course, it works better than any other clock with AppleWorks.

If you're using or writing software for other clock cards, you're still covered. Because the H.O. will *automatically* emulate them. And the Timemaster H.O. adds 14 new commands to BASIC. The H.O. even comes complete with two disks full of sample programs, including a computerized appointment book, a DOS dating program, interrupt programs, and over 30 programs that others charge extra for — or don't even offer.

As a low-cost option, you can add true BSR remote control to the H.O., giving you remote control of up to 16 lights and appliances in your home or office.

- Fully PRO-DOS and DOS 3.3, CPM and PASCAL compatible
- Time in hours, minutes, seconds and milliseconds (the ONLY PRO-DOS compatible card with millisecond capability); date with year, month, day of week and leap year
- 24-Hour military format or 12-hour AM/PM format
- Eight software controlled interrupts so you can run two programs at the same time (many examples included)
- Can be set to the second
- Allows AppleWorks to time and date stamp all data automatically
- The only clock card that displays time and date on the AppleWorks screen
- Five-year warranty

Clock price \$129.00
BSR option (may be added later) \$ 49.00

Call to order today, 9 a.m. to 11 p.m. seven days, or send check or money order to Applied Engineering. MasterCard, VISA and C.O.D. welcome. Texas residents add 5 1/2% sales tax. Add \$10.00 outside U.S.A.

AE Applied Engineering
P.O. Box 798, Carrollton, TX 75006
(214) 241-6060

COMING SOON

On-Apple

FREE on-line access available from participating Apple Dealers. Enjoy on-line product reviews, features, downloadable software, new product news, columns by famous authors, and much more!

Best of all... On-Apple will be FREE!

HOW:
WHERE:
WHEN:

With any computer and a modem
Just dial your Apple Dealer
Starting in July for the
entire family

For Advance Information
Return The Reader
Service Card

"The magazine for the rest of us!"

CIRCLE 344 ON READER SERVICE CARD

WITHOUT UNIDOS™,
YOUR UNIDISK 3.5 JUST
WON'T RECOGNIZE
AN
OLD
FRIEND.

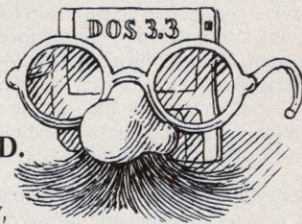

Until now, DOS 3.3 was a stranger to your Apple UniDisk 3.5. But no more!

UniDOS is DOS 3.3 for your UniDisk 3.5. It lets your 800k UniDisk 3.5 function as a dual 400k disk drive system while you work with your favorite DOS 3.3 programs and data. And it supports the Apple RAM extension cards and compatibles.

Introduce UniDOS to your UniDisk 3.5 right away. At \$35.00 they'll become fast friends.

meacom

P.O. Box 272591, Houston, TX 77277
(713) 526-5706, Telex: 4945935

Money Back Guarantee. VISA and MC accepted. UniDOS is written by David Hemmo and Marc Moini. **For Macintosh Owners:** Meacom also offers Mac + II, an AppleIIe emulator (128k, 80 column) for your 512k Mac or MacPlus. UniDisk 3.5 and Macintosh are trademarks of Apple Computer, Inc. UniDOS is a trademark of Meacom.

CIRCLE 171 ON READER SERVICE CARD

Pipeline

MAG

MACPROOF, VERSION 1.1

Version 1.1 of Automated Language Processing (A.L.P.) Systems' MacProof writing-assistance software is now available. Designed to complement college-freshman composition courses, MacProof gives students immediate feedback on their writing habits, letting them review spelling, word usage, use of verbs, and the organization and structure of their composition.

Version 1.1 enhancements include support for Microsoft Word and MacWrite, Version 4.5. The program comes with Finder, Version 4.1, and uses Version 3.2 of AppleTalk. MacProof is designed to run in a Writing Lab setting comprising 2-15 individual Macintosh workstations linked through an AppleTalk network.

Requires: Macintosh, 512K RAM, AppleTalk

Automated Language

Processing (A.L.P.) Systems, Inc.
190 West 800 North
Provo, UT 84604
(801) 375-0090

CIRCLE READER SERVICE NO. 532

MAG

BRIDGE 4.0

A version of Artworx's bridge-playing program Bridge 4.0 is now available for Macintosh computers. The program both bids and plays and enables users to replay interesting deals and switch hands among players. A new feature allows users to deal only good hands for themselves. The Macintosh version takes full advantage of the computer's graphics and mouse. It displays cards just as they would appear on a real bridge table, and users can make bids and card selections by pointing and clicking the mouse. (List Price: \$29.95)

Requires: Macintosh
Artworx Software

Company, Inc.
150 North Main Street
Fairport, NY 14450
(800) 828-6573
(716) 425-2833

CIRCLE READER SERVICE NO. 534

Incredible SwyftWare!™

It is not possible in an ad to really explain this Apple II (e or c) product which outperforms all other software in speed and simplicity. It does no-frills word processing, information retrieval, telecommunications and many other tasks. Reviewers call it "foolproof and frustration free" and "blindingly fast."

It appeals to beginners and experts. Jef Raskin, who invented the Macintosh and who later created SwyftWare, has written up the hows and whys of this product. Please write for a copy. No charge. Or order SwyftWare and see for yourself. At \$89.95 and with a 30-day refund policy, there's no risk.

US 800/982-5600
CA 800/562-7400

Information Appliance

1014 Hamilton Ct., Menlo Park, CA 94025



HYPERNET FILESERVER SOFTWARE

General Computer has introduced HyperNet, file-server software that lets users share hard-disk storage capacity, files, and programs among up to 32 Macintosh computers linked through an AppleTalk network. Each copy of HyperNet includes a host program that users can install on a Macintosh equipped with one of the company's HyperDrive internal hard-disk drives. Network users can make unlimited copies of an accompanying client program for other Macintosh computers on the network. (List Price: \$295)

Requires: Macintosh
General Computer
Corporation
215 First Street
Cambridge, MA 02142
(617) 492-5500

CIRCLE READER SERVICE NO. 535



PROPORTIONS IN GEOMETRY

The first in a line of four tutorial-level high-school math packages, Proportions in Geometry covers such topics as basic definitions and theorems, lines parallel to sides of triangles, proportions in similar triangles, mean proportions in a right angle, and proportions in a circle. The software follows New York State Core-Curricula guidelines and is useful for remediation, review, and extra-credit work. The product places emphasis on problem-solving strategies rather than actual answers

to problems and offers teachers diagnostic data and the ability to print hard copy. (List Price: \$169)

Requires: Apple II, 48K RAM

Bergwall Educational
Software, Inc.
106 Charles Lindbergh
Blvd.
Uniondale, NY 11553-3695
(800) 645-1737
in NY (516) 222-1111

CIRCLE READER SERVICE NO. 536

BOOKS

THE LOGO PROJECT BOOK: EXPLORING WORDS AND LISTS

Written by Alison Birch, *The Logo Project Book: Exploring Words and Lists* uses Logo as a tool to explore ideas about language, patterns, and mathematics. Although intended for children's use, the book is also appropriate for adults who want to learn about Logo's list-processing abilities. The book includes several projects and suggestions for modifications at different levels.

It also has an extensive glossary of Logo primitives and several appendices that discuss such topics as procedures that output, predicates, local and global variables, programming style, debugging, and tool procedures. It comes with an activities disk full of sample projects. (List Price: \$19.95)

Requires: Apple II, II Plus, IIe, or IIc; 64K RAM; Apple Logo
Terrapin, Inc.
222 Third Street
Cambridge, MA 02142
(617) 492-8816

CIRCLE READER SERVICE NO. 537

With Z-80 Plus,TM run CP/M[®]—the largest body of software in existence.

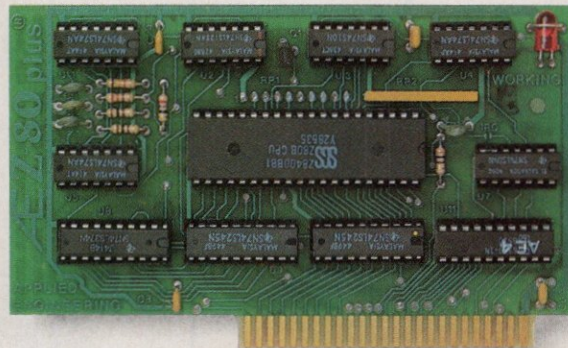

*Now, get two computers in one,
and all the advantages of both.*

Enter the CP/M world with the new Z-80 Plus card from Applied Engineering, and introduce your Apple IIe[®] or II + [®] to the thousands of CP/M programs. Only the Z-80 Plus comes standard with the new 4.0 software, the most advanced system ever for running CP/M programs.

The new 4.0 boasts advanced features like built-in disk emulation for popular memory expansion boards, boosting both system speed and storage capacity. And menu-driven utilities that let you get to work faster. The Z-80 Plus also lets you run older CP/M programs — all the way down to Version 1.6 (2.2 is the most popular).

The Z-80 Plus is the only card on the market capable of accessing more than 64K in an Apple IIe. If you have an extended 80-column card, all 128K is usable, and if you have RamWorks, up to 1088K is available.

Each Z-80 Plus comes with our CP/M Ram Drive software, enabling IIe owners to use an extended 80-column card or a RamWorks card as a high-speed Ram disk which runs CP/M software up to *twenty times faster*. So packages like WordStar and dBASE II run at blinding speed.

Simply plug the Z-80 Plus into any slot in your Apple. You'll get the benefits of two computers in one — all at an unbelievably low price (only \$139!).

- Fully compatible with ALL CP/M software
- Fully compatible with most hard disks, including Corvus and the Sider
- Fully compatible with Microsoft disks (no pre-boot required)
- Specifically designed for high speed operation in the Apple IIe (runs just as fast in the Apple II + and Franklin)
- Runs WordStar, dBASE II, Turbo Pascal, Fortran-80, Peachtree and ALL other CP/M software with *no pre-boot*
- Semi-custom I.C. and low parts count allows Z-80 Plus to fly through CP/M programs with extremely low power consumption (we use the Z-80B)
- Does EVERYTHING other Z-80 boards do, *plus* Z-80 interrupts
- Five year warranty

Call to order today, 9 a.m. to 11 p.m. seven days, or send check or money order to Applied Engineering. MasterCard, VISA and C.O.D. welcome. Texas residents add 5½% sales tax. Add \$10.00 outside U.S.A.

AE Applied Engineering
P.O. Box 798, Carrollton, TX 75006
(214) 241-6060

AppleTalk™ networks communicate better after a little bridgework.

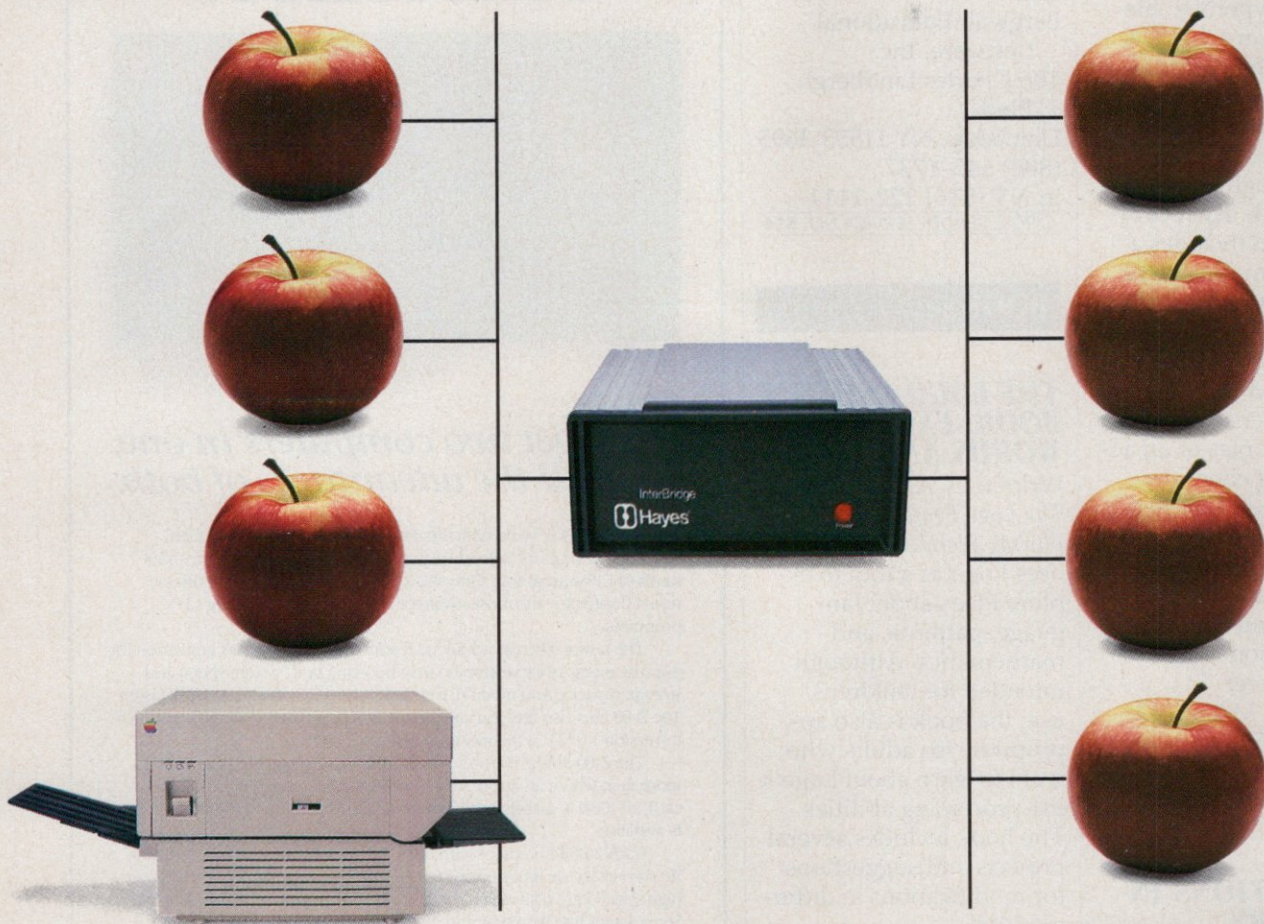

© 1986 Hayes Microcomputer Products, Inc.

It took Hayes, the PC communications leader, to bridge the gap between AppleTalk networks.

Introducing Hayes InterBridge™. There's nothing like it!

Now one AppleTalk network can communicate with another. Across the hall. Across town. Or across the country.

It's a local bridge, that lets you share information with other AppleTalk networks in your company. Or, if one network becomes overloaded, InterBridge allows you to split that network and split the workload.

It's a remote bridge, that lets you share information with AppleTalk networks everywhere. All it takes is one InterBridge and one Hayes Smartmodem 2400™ on each end.

And it permits casual access to expensive peripherals by both local and remote AppleTalk networks. InterBridge allows you to access a LaserWriter™ file servers and gateways on another network,

even if they're thousands of miles away.

This feature alone can save thousands of dollars you'd otherwise spend on dedicated peripherals for each of your AppleTalk networks!

No matter how you look at it, or how you use it, Hayes InterBridge is quite a bargain. Now you can get a lot of fancy bridgework, without a fancy price.

See your authorized Hayes dealer for details. Or contact Hayes at 404/441-1617.

Hayes Microcomputer Products, Inc., P.O. Box 105203, Atlanta, Georgia 30092.

Hayes®

Say yes to the future

CIRCLE 296 ON READER SERVICE CARD

PUTTING THE DESKTOP IN ITS PLACE

The converging path of the Apple II and the Macintosh

Add a graphic desktop program to an Apple II, and you get (choose one): an easier-to-use machine; a second-rate Macintosh; another way to access your programs; or a trendy appearance without improved performance. You'll find Apple II and Mac owners who advance each of the above descriptions and can give you a good argument for their position.

Apple itself is firmly in the pro-desktop camp now. For strategic marketing reasons, the company is committed to bringing the II and Mac product lines closer together, and the user interface is just as important as hardware or software compatibility.

Apple, quite naturally, is also interested in creating a recognizable product look and feel. Either of those considerations alone would be enough to motivate Apple's backing of Catalyst (domestically) and MouseDesk (internationally), both of which provide a Macintosh-like desktop for Apple II machines.

There's more to this issue, though. Graphic desktops are a different mental outlook or metaphor, a different way of looking at human/computer interaction. They're also, in a strange way, more fitting even for the II than they are for Apple's other line of computers. And, as we shall see, they're part of a lesson the II can teach as well as one it can learn.

Actually, though, two very different types of desktop programs are available for the II, playing two very different roles in the system. Catalyst and MouseDesk are limited operating

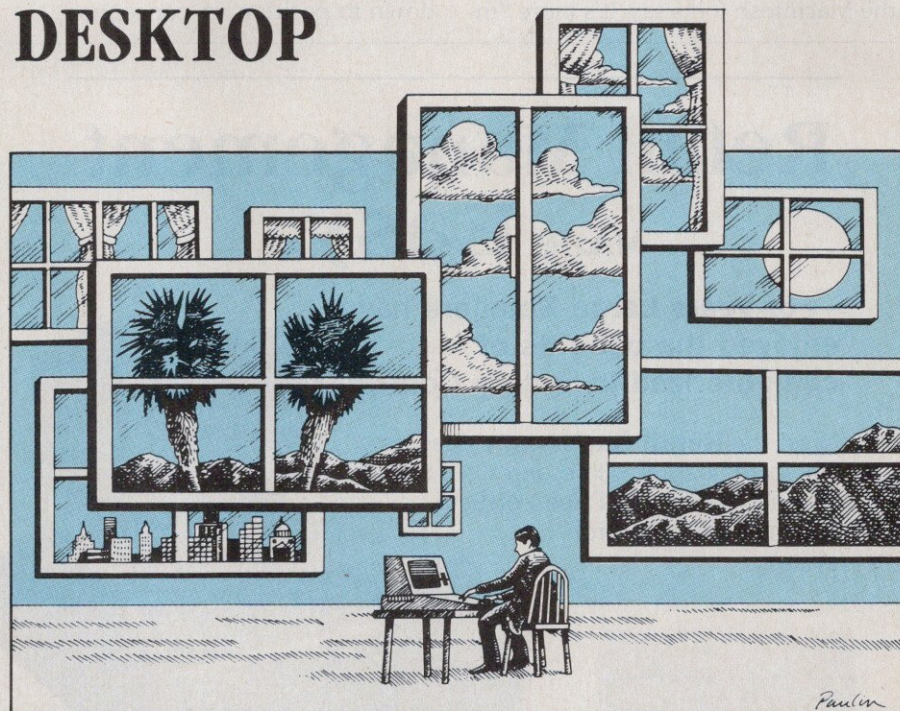

environments, acting with the ProDOS operating system to find and start other computer programs. On the other hand, programs such as Jeeves and Pinpoint are tool and accessory sets for office applications.

Consequently, you normally use the first type of desktops *before* you

Graphic desktops are a different way of looking at human/computer interaction.

run your usual application programs. Once an application is running, the desktop gives up control and doesn't reappear until you quit the application and return to what would otherwise be the ProDOS system prompt.

The second group of desktops, in contrast, run *during* your programs, as pop-up and pop-down windows that are always lying in wait. They are

thus two steps removed from the first group and may or may not use a graphic interface.

On the Mac, the groups are closely related because tools and accessories are accessible from menu bars, which remain active and available during the use of application programs. The tools available before you launch an application program remain the tools during program execution.

That situation isn't possible on the II, however, because of the more limited role of the operating environment. Whereas the Macintosh operating system was written before the appearance of any Mac application software, leaving a clear set of rules for application programs, the Apple II desktop environments were written after most Apple II application programs and thus have to take programs as they find them.

Environmental Concern

For now, though, let's put aside the tool-type desktops and take a closer look at the first type of desktops, the

operating environments. Most first-time Apple II users prefer the icon-and-mouse approach to the ProDOS command-line method, especially now that most first-time buyers are not computer fanatics but people who see the machine as a means to a goal.

Users find seeing what is on a disk by clicking the mouse over an on-screen image easier than worrying about giving commands and remembering paths or slots and drives. As the Macintosh folks say, it's more "in-

tuitive." That advantage will also increase as the II continues to get more capacious storage choices and a wider range of peripheral types. Although the ProDOS operating system insulates users from changes in the hardware much more than did the prior DOS 3.3, you still have to deal with complex mental constructions to use ProDOS to access multiple files on different volumes. The differences between the graphical interface and the command-line approach boil down to position vs. conception.

Even for more advanced users, the mouse point-and-click method has its advantages. Copying disks, for example, is much easier with Catalyst than it is with the multilevel menu system of the ProDOS Filer utility, for instance.

A Mixed Blessing

The graphical approach is not entirely an improvement, however. Some of what desktops gain in ease of use comes at the cost of a more rigid approach. Desktops, for example, don't do very well with self-starting applications. Even though part of the impetus for creating software that boots and runs may have been the difficulties many users had with the command-line interface of the plain operating system, most of us have a whole collection of this software. There's not much point in running a desktop if you normally launch into programs by rebooting.

Desktops also have trouble distinguishing programs from data. Because ProDOS keeps track only of a few special kinds of files, a desktop can't normally tell if an unmarked file contains instructions for you, for an application program, or for the operating system.

You can tell the desktop which files are which by installing the programs, but if you're doing a lot of changing around of disks and running a lot of files through the system, you have to do a lot of installing and removing to keep your system up to date. If you stick with plain ProDOS, you can just swap disks.

Desktops can also get in the way of full communication between you and your program. The point-and-click model doesn't provide any good means of giving an application program an initial set of parameters or of setting options from a command line. Similarly, they give you only a limited ability to set up macros or record procedures, so you must do most desktop tasks one step at a time.

The limited scope of the Apple II desktop programs can also be a problem. Because the desktops cede complete control to application programs, the desktop environment doesn't provide any consistency for the application's user interface. Not only does this mean that each application can have its own different interaction style, but it means the desktop becomes one *more* program you have to learn and remember.

Consistency is always a double-

Retail Management MADE Easy

For years Large Retailers have enjoyed the benefits of computerized Inventory Control.

Now! the **Retail Supervisor** enables you to realize the Time and Cost savings of a fully automated Point-of-Sale and Inventory Control system.

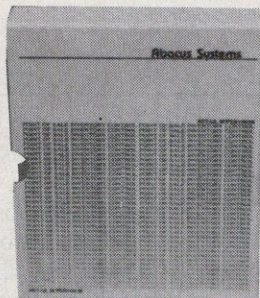

Clear, concise reports allow you to eliminate Overstocks, identify Slow Movers, reduce Stockouts and improve Profit Margins.

The Retail Supervisor will give you control of your Inventory Investment and enhance your ability to make profitable Management Decisions.

The Retail Supervisor will consistently contribute more to your profits than any other Investment you can make. To see how the Retail Supervisor can improve your Bottom Line,

Call for a dealer near you.



Abacus Systems™

707 Cass St., La Crosse, WI 54601, (608) 785-1740

The Retail Supervisor is available for the Enhanced Apple IIe and Apple IIc.

Apple is a registered trademark of Apple Computer, Inc. Retail Supervisor, Abacus Systems, and the Abacus Systems Logo, are trademarks of Abacus Inc.

CIRCLE 114 ON READER SERVICE CARD

InfoMerge

For AppleWorks™

\$79

On-screen, direct-print mail merge program. Uses AppleWorks database and word processor files, direct database manipulation.

Local/global keyboard inputs, field calculations, automatic reformatting, optional on-screen formatted print preview, and more.

Works with Pinpoint!

Pinpoint

24 Hour Toll Free Order Phone
800-633-2252/Ext. 580

Micro Cookbook

\$49.95

Instant Menu Planner
3,000 Recipes Available
Adjusts Ingredients for
Number of Servings
Valuable On-Line Reference
Automatic Shopping Lists

Pinpoint

24 Hour Toll Free Order Phone
800-633-2252/Ext. 580

Point to Point

by Gary Little

\$129

Powerful telecommunications software with AppleWorks™ filecard interface. Send/receive files unattended (with clock), powerful programming macros eclipse AE Pro. XMODEM binary/text file transfers, 2400 Baud modem support and more. Works with Pinpoint on your Apple IIc/IIe!



Pinpoint

24 Hour Toll Free Order Phone
800-633-2252/Ext. 580

Box 13323, Oakland, CA 94661

CIRCLE 152 ON READER SERVICE CARD

edged sword, and one of the attractions of the Apple II line has always been its variety of software and the range of available approaches. If you take word processing, for example, you'll find dozens of software choices on the II, one of which probably suits any particular work style and mental orientation. On the Mac, however, you'll find only a handful of word-processing programs, and most work in about the same way.

Pick and Choose

Still, some optional standards would be nice. International Solutions, the publisher of MouseDesk, has come out with a line of business programs that use the same interface as the company's desktop software, and other programs such as Roger Wagner's MouseWrite and Trutec's Person to Person telecommunications program also use a Mac-like approach. But so far, no announced program from Apple or anyone else ensures a consistent desktop and application-program user interface.

I believe the optional-standard approach is particularly fitting for the II series, because it continues the tradition of an open but supported architecture. Although, in electrical terms, you can put most cards in most slots in an Apple II, in most cases you want to go with the standard arrangement. If the circumstances call for another arrangement, though, it's no big deal to do it a nonstandard way. Desktop-related program-interface standards should be the same way.

In fact, having a graphic desktop as the operating-system interface should be an option. At times you can get more done with a command line or perhaps a menu-driven operating-system-shell program. The engineers of the Macintosh—who originally assumed that users didn't need open-ended choices, only limited numbers of predefined selections—seem slowly to be learning that lesson.

So watch not only how the II desktops evolve over the next year or two, but also the Macintosh itself. The II may become more Mac-like, but you'll also see more II-like features on Mac desktops.

Shall we say that the Mac's lesson is graphical interfaces and software consistency? In that case, the II stands, as always, as a beacon on the virtues of openness and configurability. And that's nothing to keep permanently hidden under anybody's desktop.

FREE? DISKETTES

SAVE MONEY! Apple II series users can use the diskette flip side, if another "write enable" notch is correctly made.

TOP NOTCH by QUORUM quickly **SOLVES** that **PROBLEM**. It's like **FREE DISKETTES!**



- Stainless Steel Guide
- Easy Leverage Handle
- Clippings Catcher
- Square Notch Cut
- Black Finish

Lifetime Warranty

Awarded the only A+ GRADE in a comparison test published by the INTERNATIONAL APPLE CORE.

"The best I've found..."

IAC Reviewer

Certifix™

BE SAFE! The flipside of a single sided disk may have flaws. Any disk is **CERTIFIED 100% ERROR FREE** with **CERTIFIX**. IT "LOCKS OUT" BOTH **DOS 3.3 & ProDOS DISK FLAWS**.

- LOCKS OUT ProDOS & DOS 3.3 FLAWS
- SAVES STATUS REPORT ONTO DISK
- AUTOMATIC ProDOS/3.3 FORMATTING
- CREATE 40 trk DISKS & SYSTEM MASTER
- RECORDS TEST DATE onto disk
- NOT COPYPROTECTED

FREE CERTIFIX BONUS PROGRAMS

- Undelete DOS 3.3 files
 - Test and Adjust Disk Drive Speed
- Prevent Data Loss!**
CERTIFY & FIX every disk with CERTIFIX!

Get THE BEST!

Ask our Customers:

U.S. National Bureau of Standard
TRW • IBM • Digital Research • AT&T
U.S. Naval Weapons Research Center
Alcoa • Rockwell International
General Electric Corporation

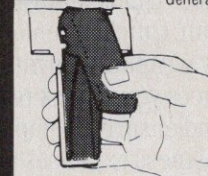

FREE!

64 Write Protect Tabs
32 Diskette Labels
If you get the **DISKETTE FLIP-KIT** which contains **TOP NOTCH** and **CERTIFIX**

*100% Money Back
Satisfaction Guarantee!*

DISKETTE FLIP-KIT only \$29.95

TOP NOTCH is \$14.95

CERTIFIX is just \$24.95

Add \$2 s/h • CA add 6.5% tax

For your nearest dealer
or to order direct.

CALL TOLL FREE

1-800-222-2824

In CA: 1-800-222-2812

From 8 am - 5 pm PST



Dealers Invited

QUORUM INTERNATIONAL, Unltd.
INDUSTRIAL STATION P O BOX 2134 AP
OAKLAND, CA 94614

CIRCLE 223 ON READER SERVICE CARD

"Indispensable"

A+ magazine

"...an excellent piece of software in all respects, and with the power of AppleWorks... it's more than good, it's indispensable."

A+ magazine

"...a program that truly saves time when it comes to paying bills and keeping track of tax deductible items..."

Parents magazine

"Ease of setup	★★★★
Ease of use	★★★★
Documentation	★★★★
Support	★★★★
Overall	★★★★

inCider magazine

(★★★★ is inCider's highest rating)

Quicken™ earned its rave reviews by showing just how much time and hassle a good financial software program can save. Whether for home or small business, Quicken is the fast and easy solution to routine finances.

How much time does Quicken save? It cuts your monthly bill-paying chores in half. Quicken remembers your regular bills and automatically writes and prints the checks for you. It maintains and balances your check register, eliminating tedious clerical work and ensuring complete, accurate records. Quicken also tracks business expenses and tax deductions, and will transfer data to AppleWorks™ spreadsheets for custom financial reports. And because it looks and acts like AppleWorks, Quicken is familiar and very easy to use.

It's no wonder Quicken is the only software endorsed and sold by major banks across the country, including Wells Fargo Bank, United Banks of Colorado, Shawmut, Mellon Bank, First National Bank of Maryland, Manufacturers Bank, Texas Commerce Bank, Bank of Hawaii, Fairbury State Bank and Fort Wayne National Bank.

Call today and try Quicken free for 30 days. You'll agree that Quicken is more than just good. It's indispensable.

Quicken runs on Apple® IIc and IIe* with one or two floppy disk drives (IIe requires extended 80-column card). Also works on UniDisk™ 3.5 and with any printer. Quicken works with any checking accounts and any financial institutions. *Also IBM® PC, XT, AT.

30-DAY FREE TRIAL. No charge will be made until 30 days after receipt of Quicken. Allow two weeks for delivery. If you're not completely satisfied, return within 30 days and no charge will be made.

TO ORDER QUICKEN FOR \$79.00 CALL TOLL-FREE 800 624-8742. California residents call 800 468-8481. \$3.00 for shipping and handling and state sales tax where applicable will be added.

Quicken™

Checking & Finance Software

Intuit, 540 University Avenue, Palo Alto, CA 94301 (415) 322-0573.

Quicken is a trademark of Intuit. Apple is a registered trademark of Apple Computer, Inc. AppleWorks and UniDisk are trademarks of Apple Computer, Inc. IBM is a registered trademark of International Business Machines Corp.

APPLEWORKS VERSIONS CONFUSING

Q. I own AppleWorks, Version 1.1. I went to my dealer for the 1.2 upgrade, and he had no data, specifications, or anything to explain what changes had been made. The copies he made for me would not run on my IIc, so he recopied them. The new copies were OK, but now I find I cannot make backups with my IIc utilities disk. Why can't I make backups as I could with my original 1.1 version, and what are the differences among the 1.1, 1.2, and 1.3 versions?

A. Version 1.0 was replaced by Version 1.1 after only a few months. Version 1.1 contained a new manual to accommodate IIc owners (this version was introduced with the IIc) but was found to have problems with non-Apple parallel printer cards. It seems that most printer-card manufacturers emulated Apple's older-style cards that were created with BASIC programs in mind. These cards automatically sent a carriage return at the end of each 80-character sequence. Unfortunately, ProDOS doesn't want those carriage returns, and they can cause problems in ProDOS programs such as AppleWorks (one symptom was that 80N printed mysteriously at the top of the page).

Version 1.2 overcame the non-Apple parallel-card problems by allowing you to issue control commands to the card itself, telling it to turn off the automatic carriage return after 80 characters. The procedure involves entering the Other Activities option from the main menu and then selecting the Specify Information about Your Printer(s) option. Next, you choose your printer under the Change Printer Specifications option and select the Interface Cards option. You can now change the card's automatic carriage return from 80 to 0 by entering the code Control-I ON.

Version 1.2 of AppleWorks also

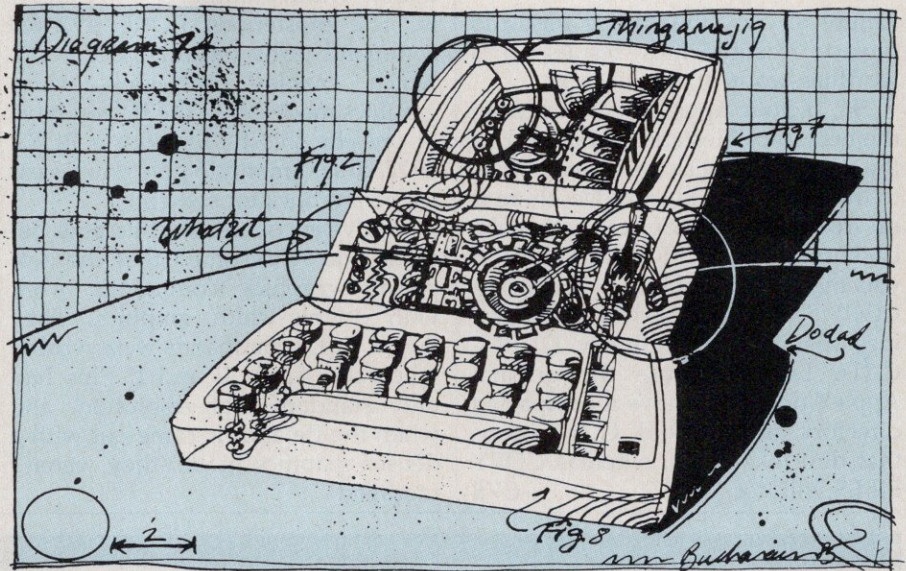

added new printers to the Select Printer option and overcame problems with the underline and boldface codes on the Epson MX printers. Memory upgrades from various manufacturers come with software that

locate information on a 3.5-inch disk, and it lets you format a disk within AppleWorks so you don't have to use the system utilities. If you have Apple's Memory Expansion Card in your computer, this version will increase the desktop from 55K to about 800K. It will not, however, increase the record limit in the database program, the size limit in the spreadsheet program, or the line limit in the word-processing program (Apple maintains that it will soon increase these limits).

Currently, memory upgrades from other manufacturers increase these limits, but they work only with Version 1.2 of AppleWorks. Version 1.3 is the only upgrade that is not free from dealers. It costs \$20 from Apple, unless you purchase a Memory Expansion Card, in which case it's free. It is also the only version with an addendum to the manual.

When dealers upgrade your existing disks, they simply copy certain files from the new version, adding new ones and replacing any with the same name. The 1.2 upgrade consists of these files:

If you have Apple's Memory Expansion Card in your computer, Version 1.3 of AppleWorks will increase the desktop from 55K to about 800K.

modifies this version to allow it to recognize extra memory, and most of them work quite well. Quark's Catalyst, Versions 2.0 and 3.0, also work with Version 1.2.

Version 1.3 adds some minor features to AppleWorks: It recognizes the UniDisk 3.5 as a disk drive, so you don't have to type pathnames to

AppleWorks.System (program code)
Seg.M0 (memory-resident code)
Seg.M1 (memory-resident code)
Seg.PR (printer information)
Seg.00 (booting and loading code)

The 1.3 upgrade consists of these files:

AppleWorks.System
Seg.M0
Seg.M1
Seg.PR
Seg.00
Seg.XM (extra memory code)

Failure to copy the correct files and replace existing files results in a worthless copy of AppleWorks.

So, if your upgrade contained all the necessary files and you copied all the required files, as explained above, to the best of my knowledge, there is no reason why you cannot make backups with your IIc utilities disk. If you made your backup by choosing COPY FILES from the IIc system utilities menu, you might try DUPLICATE DISK, because the original AppleWorks disks have a compacted directory, and the DISK COPY keeps that directory intact, whereas COPY FILES will not.

—CVB

APPLESOFT AND DOUBLE-WIDTH GRAPHICS

Q. I read in your Inside the Apple IIe book that you can turn on double-width high-resolution graphics from Applesoft by following a PR#3 command with HGR and POKE 49246,0 commands. I've done this, but my line-drawing program doesn't seem to work properly. For instance, when I draw a horizontal line with HPLOT, I get a dashed line instead of a solid line. Can you tell me what I am doing wrong?

A. You are certainly enabling the double-width graphics screen properly. The mysterious POKE 49246,0 command turns on annunciator #3, which enables the double-width graphics modes. (On the IIc you have to precede this POKE with a POKE 49278,0 command to give you access to the annunciator switch.)

You've encountered difficulties because you've assumed that the Applesoft graphics commands work with double-width graphics. They don't! These commands were written when the Apple II and II Plus had only standard high-resolution, and when the IIe and IIc came out with a denser graphics mode, they weren't modified.

The reason you see a dashed horizontal line is that every graphics row on the screen is mapped to an interleaved series of 40 bytes in main memory and 40 bytes in auxiliary memory. (Each byte defines 7 adjacent pixels.) When HPLOT draws a line, it stores data in main memory only, so there are gaps for the pixels that correspond to auxiliary memory bytes.

The solution is not a happy one for Applesoft programmers: Write your drawing routines in assembly language. This is not simple, but it's about your only choice until Apple decides to rewrite Applesoft.

If possible, get your hands on a superb article entitled "True Sixteen-Color Hi-Res" by Allen Watson III. It appeared in the January 1984 issue of *Apple Orchard*, and it describes a set of subroutines you can call from Applesoft in order to use double-width graphics efficiently. If you aren't able to locate this issue, contact the publisher, International Apple Core, at (408) 727-7713.

—GL+

Please send your questions and problems to Rescue Squad, A+, 11 Davis Drive, Belmont, CA 94002.

RAMWORKS®

**ACCEPT NO SUBSTITUTES.
BECAUSE THERE AREN'T ANY.**

There's only one card like RamWorks. Others may say they're RamWorks compatible but they're not! We've got the best hardware design. We supply the best software and we've got the best support from software companies.

If someone tempts you with an imitation, please get both sides of the story. You'll discover why RamWorks offers the best enhancements to AppleWorks and other programs, and at the lowest price.

GUARANTEED!

**214-241-6060
9 AM - 11 PM
7 Days a Week**



**"We Set the Standard"
APPLIED ENGINEERING**

APPLYING APPLEWORKS™

FIRST EDITION SOLD OUT!

NEW SECOND EDITION NOW AVAILABLE

Teachers! Coaches! Businessmen! Everyone!

DISCOVER the AppleWorks™ book written with educators in mind. Go from beginner to advanced applications.

CREATE your own standard letter formats, seating charts, gradebooks, test question bank, sports scoring sheets, accounting ledgers, mailing labels, budgets, bibliography files and much more.

DISCOVER the integrated use of the UNIDISK 3.5, Pinpoint™, AppleWorks Mailing Program, Spellcheckers, Proofreaders, and many other AppleWorks™ compatible software and hardware.

SEND \$11.95 plus \$1.50 for shipping, a total of \$13.45 in U.S. funds (Add \$5.00 for countries other than USA, Canada, or Mexico).

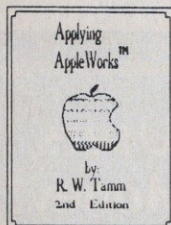

BRISTEN PRESS
DEPARTMENT A+
P. O. BOX 336
NEW HARTFORD, NY
13413

ISBN 0-936337-01-X

CIRCLE 166 ON READER SERVICE CARD

Macintosh Aficionados

A+ would appreciate receiving any tips, hints, shortcuts, or suggestions that you have for using the Macintosh computer. We would like to publish these pearls in our MacTips feature in our Macintosh section. You'll receive credit in the magazine, and we'll pay \$50 for each MacTip that we use. Send your

tips to:

MacTips

A+ Magazine

ATTN: Chip Carman

11 Davis Drive

Belmont, CA 94002

INTERNAL HARD DISK SYSTEM FOR THE APPLE II® THE CHALLENGER

10 & 20 MB



PRODOS, DOS, PASCAL & CP/M COMPATIBLE
NETWORKING & TAPE BACKUP AVAILABLE

CONTACT: SPACE COAST SYSTEMS INC.
P.O. DRAWER 2767
301 S. WASHINGTON AVE.
TITUSVILLE, FL 32781
(305) 268-0872
TELEX: 701506

CIRCLE 135 ON READER SERVICE CARD

APPLE(II+)WORKS PLUS-WORKS™

It Really Works!!

PLUS-WORKS not only allows you to have all features of AppleWorks™ on an Apple II™, II+ or compatible, but our extended memory versions give you capabilities far beyond the standard II/c versions. Its great for expansion on the Apple IIe as well.

Compare these features with other AppleWorks patch programs

- Copyable - make backups, transfer to hard disk
- Up to 1 megabyte of **desktop** space available
- Database expansion to more than 4,200 records
- All control codes available to printer
- Supports Franklin computers and all full ASCII keyboards
- Supports all major 80 column cards
- Permanent and dynamic ram disk features
- All versions of AppleWorks supported, even V1.3
- Expand AppleWorks desktop into CP/M ram cards
- Optional patch to help with printer problems

•PLUS-WORKS - \$19.95 plus \$3.00 ship/hand. Requires AppleWorks, 64K Apple II+ or compat, 80 col card and shift key mod. Maximum desktop 10K. You may upgrade to XM for \$30.00 at any time.

•PLUS-WORKS-XM - \$49.95 plus \$3.00 ship/hand. Requires same as above with legend, saturn, or compatible ram card(A.P.P.L.E. Big board, know Drive, prometheus, etc), Apple Computer's memory expansion card, Microtek ram card, Orbital disco-ram, PCPI Applicard, Micropro Star card, IBS AP33 ram card, or Apple IIe with ramcard.

•PLUS-WORKS-XMB-Special version for Basis 108, \$49.95 plus \$3.00 ship/hand

•PLUS-WORKS-L - Special version for Laser 3000, 10K desktop - \$19.95 plus \$3.00 ship/hand.

•Special combination offer - PLUS-WORKS-XM & 256K Apple Memory expansion card (expandable to 1 megabyte) - \$295.00

MC/Visa add 4%

Orders only 1-800-221-3826

Information, Alaska & New Jersey residents call 516-922-9584

or send check or money order to:

Norwich Data Services
PO Box 356

East Norwich, NY 11732-0356

NYS residents add appropriate sales tax

Dealer inquiries invited

Apple & AppleWorks are trademarks of Apple Computer Inc.
PLUS-WORKS is a trademark of Norwich Data Services Ltd.

CIRCLE 101 ON READER SERVICE CARD

A+ MART A+ INDEX

POWERFUL DATABASE on a disk summarizes every article, review, program, letter & tip in A+ Magazine.

Cross-references corrections & updates. End fruitless searches thru stacks of magazines!

A "tip-book" citing 1000's of solutions
A+ EDITORS USE IT & LOVE IT!
GUARANTEED to save you TIME and MONEY.

\$5 for 1985, \$9 for 1983, 1984 & 1985
Monthly updates \$5 ea. or \$18 for 4 qtrs. or \$39 for 12 mos.
Works on all APPLES and Macintosh.

FASTFIND Not Copy-Protected

High-speed search utility. Searches any 100 sector text file in 1 second, loads them in 6 seconds. AND/OR/NOT logical operators & wild card. Searches multiple files & disks with single keypress. Up to 100 times FASTER than word processors! Finds lost files, even if you forget their names! Prints reports. A.P.P.L.E.'s BEST SELLER. Bonus super-fast HD SPEEDOS. For APPLE II, II+, IIe, IIc or III. List \$49.95.

\$12 & get A+ INDEX '83, 84 & 85 **FREE**
(Add: CA res. 6.5%, credit card 4%, Mac 3.5" disk \$2, overseas \$3)
FASTFIND CO., 28503 Coveridge Dr. #A, R.P.V., CA 90274
(Modem: 213/377-0804) VISA/MC 213/544-2350

CIRCLE 600 ON READER SERVICE CARD

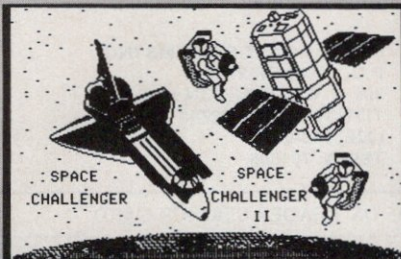

THAT'S RIGHT!! GET TWO EXTREMELY CHALLENGING GAMES FOR HALF THE PRICE OF JUST ONE. PLAY ALONE OR PLAY WITH A GROUP OF UP TO FOUR FOR SOME REAL COMPETITIVE FUN. MANY & MANY HOURS OF ENJOYMENT FOR THE KIDS AND THE ENTIRE FAMILY.
<<< \$13.95 >>>

LODE RUNNER III: 150 NEW CHALLENGING DATA DISK LODE RUNNER LEVELS FOR THE KIDS TO CONQUER. INCREDIBLY LOW PRICE OF ONLY...
<<< \$8.95 >>>

BUY BOTH PACKAGES AVAILABLE FOR APPLE COMPUTERS FOR ONLY <<< \$19.95 >>>

ORDER NOW SEND CHECK OR MONEY ORDER TO
CHIC
4882 WEST WEAVER RD. DEPT 'A'
HAMPTON VIRGINIA 23666
(804) 827-8243

(1/4 RESIDENTS ADD 4% SALES TAX.)

CIRCLE 602 ON READER SERVICE CARD

68000 for your Apple UNDER \$200 !

Our line of hardware & software systems for Apple II+, IIe includes a 68008 card, assembler, & FORTH for under \$200 !

Write or call today for our 68008/6809 product catalog.



26 W. Mission Street P.O. Box 696
Oakview, CA 93022 (805) 569-3132

CIRCLE 605 ON READER SERVICE CARD

Nashua Diskettes

5 1/4" DS/DD with hub ring and sleeve, factory warranted, packaged in 50's. Shipping Extra. Quantity 50, 85¢ each.

The same low price our volume copying customers pay!
75¢ each Qty. 100

We sell 3 1/2" & 5 1/4" disks—all types, major brands. Call toll free:

1-800-321-4668

in Colorado, 303-234-0871

VISA, MASTERCARD, OR COD ACCEPTED

ALF 1315-F Nelson St.
Denver, CO 80215

ComputerEyes™

CALL TOLL FREE
1 (800) 523-2445, x48
In PA (800) 346-7511, x48

- Make Custom T-SHIRTS
- Take Computer Portraits
- Interface to ANY Standard Video Source (ex. VCR, Video Camera, etc.)



Computer Eyes™ For APPLE (II, II+, IIe, IIc).....	\$109.00
Software interface to:	
Print Shop	12.00
Double Hi-RES (IIe)	12.00
Newsroom	12.00
Panasonic/Ikegami Commercial grade B/W video camera.....	159.00
Special Hook-up cabling with instructions	19.00
UNDERWARE ribbons to make custom heat iron-on transfers for T-Shirts, scarves, etc.	12.00
Color Pens	12.00

Also Available for ATARI, C-64 and IBM

HAL Systems, PO Box 293,
Scotch Plains, N.J. 07076

*** DEALER INQUIRIES INVITED ***

CIRCLE 603 ON READER SERVICE CARD

— BUY DIRECT AND SAVE FULLY APPLE COMPATIBLE

Z-80 CP/M Card	\$ 39
80 Column Card w/Inverse (Videx compatible) ..	\$ 58
Autoterm 80 Col w/Softswitch & Inverse (Videx comp.)	\$ 68
Extended 80 Col w/64K Apple IIe	\$ 48
Disk Controller for 2 Drives	\$ 39
Parallel Printer Card w/Cable (Epson comp.) ..	\$ 37
Graphic Printer Card w/Cable (Parallel)	\$ 48
Micro Buffer Graphic Printer Card w/32K & Cable	\$ 99
Super Serial Card w/Cable	\$ 80
16K RAM Card w/Cable	\$ 37
128K RAM Card w/Software & Instructions (Titan, Saturn compatible)	\$120
Numeric Key Pad for Apple IIe	\$ 39
Super Cooling Fan w/2 outlets	
Lighted Switch, Surge/Filter	\$ 34
Joy Stick all Metal, Heavy Duty, Fine Tuning, self centering Apple II/II+, IIe & IIc (Specify) ..	\$ 25
Diskette Storage Box w/Lock & Key, Holds 100 ..	\$ 15
Disk Notcher w/Guide, All Steel, Square Cut ..	\$ 8
Slim Disk Drive - Direct Drive w/Elec Sensor, Super Quiet, 1 Yr Warranty - Apple II+/IIe ..	\$135
Apple IIc	\$145

ASSEMBLED, TESTED & 6 MONTH WARRANTY
Shipping & Handling Under \$100/10% — Over \$100/5%
School & Institutional P.O. Accepted - Dealer Inq. Invited

HOURS: MON-FRI 9-6 EST

COMPUTER SUPPLY

P.O. BOX 164A, VALLEY STREAM, NY 11582

(516) 239-1854

CIRCLE 606 ON READER SERVICE CARD

TERMINAL EMULATION

Softerm 2 emulates over 24 popular terminals including the:

- DEC VT52, VT100, VT102
- Data General D200
- IBM 3101-20 (block mode)
- Hewlett-Packard 2622A
- Honeywell VIP7801, VIP7803

Guaranteed Compatibility

Call for free product brief

\$195 MC-VISA-COD

For the Apple II, II+, IIe, IIc and compatibles

SOFTRONICS

7899 Lexington Dr., Ste 210
Colorado Springs, CO 80918
(303) 593-9540

CIRCLE 601 ON READER SERVICE CARD

P.F.S.* Users, Time is Money!

Your entire program can run 2 1/2 times faster with our New Speedup System!

*trademark; Software Pub. Co.



P.O. Box 696
Oakview, CA 93022
805 569-3132

CIRCLE 604 ON READER SERVICE CARD

DISKETTES

Why PAY more??

39¢ ea 5 1/4 DS/DD
Soft Sector
Bulk Quantity 100

Each Diskette 100% certified at Manufacturer

LifeTime Warranty

ACT NOW! These are not seconds.
MONEY BACK GUARANTEE!
No questions asked.

MEI ORDER LINES
USA ORDER LINE 800-634-3478
OHIO ORDER LINE 614-481-4417

MEI
1555 West Lane Ave.
Columbus, Ohio, 43221

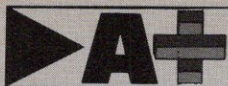

NEW!



SafeSkin™
KEYBOARD PROTECTOR

Remains in place during keyboard use. Prevents damage from liquid spills, dust, ashes, etc. Fits like a second skin, excellent feel. Available for: IBM-PC, AT, Apple (all), Compaq, Model 100, NEC 8201, C64, Zenith 150, DEC, Kaypro, KB5151, AT&T 6300, WYSE 50 and many others. Send \$29.95, check, M.O., Visa & MC include exp. date. Specify computer type. Dealer inquiries invited. Free brochure avail.

Merritt Computer Products, Inc.
2925 LBJ Fwy, #180 / Dallas, Texas 75234
(214) 339-0753

CIRCLE 607 ON READER SERVICE CARD

HARD DISK SYSTEMS

APPLE II+, APPLE IIe, APPLE III

"Quick Series"

20mb Starting \$795.00

ProDOS PROGRAM SELECTOR
INSTALLED FREE!

Very Fast Read/Write, Auto Boots, Compatible with Extended Memory and Speed Up Cards.

ProDOS and DOS 3.3	Now Only	Reg. Price
20mb Complete System	a \$ 795.00	\$1159.00
30mb Complete System	a \$1195.00	\$1695.00
40mb Twin 20 Drives	a \$1295.00	\$1795.00

NovoComp Apple II Hard Disk Utility Software

Variable size partitions, any or all systems
DOS 3.3, Pascal 1.2, ProDOS 1.1.1, CP/M a \$150

90 Day Warranty Included - Add 1 Year	a \$ 50
Delivery via UPS Insured Ground	a \$ 15
ProSEL Allows DOS 3.3 on ProDOS Device	a \$ 39

Money Back if performance not satisfactory

CMC Computer Systems Phone: 714/835-2462
1514 East Edinger #H Santa Ana, CA 92705

CIRCLE 608 ON READER SERVICE CARD

APPLE® II CLONE

Personal Computer System
with AUTO-BOOT 20mb HARD DISK

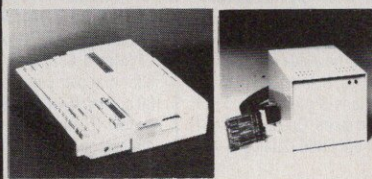

Video Tech Laser 128

Quick-20

Portable Style Computer with One Drive, 128K RAM, Serial, Parallel, Modem and Mouse Ports. Numeric Pad, 10 Function Keys and Expansion Slot. A Mono Monitor Plus 20mb Hard Disk and ProDOS Program Selector. Supports Hi-Res Video and most popular Apple® IIc/IIe Software.

Regular \$1895.00 Now Only \$1295.00

CMC Computer Systems Phone: 714/835-2462
1514 East Edinger #H Santa Ana, CA 92705

CIRCLE 609 ON READER SERVICE CARD

MACINTOSH

512K MEMORY

MOUSE

KEYBOARD

SOFTWARE

COMPLETE SYSTEM

\$1595

CALL 213 540-5513
OR IN ILL 312 352 4001

STORAGE DATA/KELLECO
VISAMASTERCARD

CIRCLE 611 ON READER SERVICE CARD

REPRINTS AVAILABLE

Quantity reprints of articles appearing in A+ Magazine are available and will be prepared to meet any special requirements. Inquiries should be directed to Eileen Pfeiffer, Reprints Dept., Ziff-Davis Publishing Co., 1 Park Ave., New York, New York 10016, Phone 212-503-5447



Did You Know...

that the average A+ reader has invested more than \$5,200 in their Apple system?

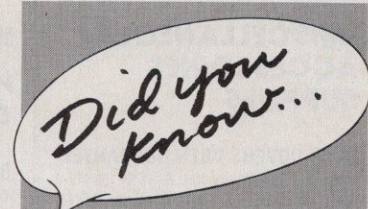

that for every copy of A+ sold, at least three additional users read it! Over 600,000 Apple owners, users and buyers read A+ every month!



ADVERTISING RATES AND INFORMATION

Standard listings consist of a bold lead line (25 characters maximum); 7 lines of body copy (45 characters per line); 4 lines for company name, address and telephone number, \$245 per insertion—3 issue minimum. Additional charge for extra lines and company logos. Prepayment and frequency discounts available. American Express, MasterCard, Visa accepted. Copy subject to publishers approval. Send typewritten or printed copy, reproducible logo art (if applicable) and remittance to Kathryn Cumberlander, Classified Sales Manager, Ziff-Davis Publishing Company, One Park Avenue, New York NY 10016. For additional information, assistance, or to place an order by phone, call collect (212) 503-5115.

▶ACCESSORIES/ SUPPLIES

DISCOUNT PRICES!

5 1/4 Disks: 10 for \$5.98, 100 for \$55.00, 1000 for \$400.00. Modems: Novation, Hayes, Smarteam. Apple IIe professional for \$1199.00. Apple IIc for \$749.00. Printers: Star, Epson, Okidata, Panasonic, call for prices. Software always discounted 30%.

Sy Draft
26130 Greenfield Avenue
Oak Park, MI 48237
1(800) 321-2695/(313) 968-2620

▶MISCELLANEOUS/ ACCESSORIES SUPPLIES

DUST COVERS WITH GUARANTEE

Vinyl dust covers lint free & water resistant Apple II or IIe \$7.50 Apple IIc, Scribe Printer or Imagewriter reg. carriage \$8.50 Apple IIc disk drive \$7.50 Apple IIe monitor on CPU \$16.00 & many more. Colors: blk., brwn., base, tan, white. S.A.S.E. for more info. Add \$2. s/h. Chk/MO/VISA/Mastercard accepted. J/Check Software
P.O. Box 345
Millry, AL 36558
(205) 846-2360

▶COMPUTER INSURANCE

SURE IT'S INSURED?

If your computer is important to you, insure it! SAFEWARE provides full replacement of hardware, media and purchased software. As little as \$39 a year covers fire, theft, power surges, earthquake, water damage, auto accident. Call 8am to 8pm Mon. thru Fri. Sat. 9am to 5pm.
SAFEWARE, The Insurance Agency Inc.
2929 North High Street/P.O. Box 02211
Columbus, OH 43202
800/848-3469 (Nat); 614/262-0559 (OH)

▶APPLE III

WOULD YOU BELIEVE?

That the ON THREE DESKTOP MANAGER, THE NEW Mac-like utility will completely clear off your desk and do everything but the dishes! Imagine, a full function calculator, appointment calendar notepad and clipboard for information transfer. Use Mouse from any application. Now available, ASCII Chart and Disk Utilities. Coming soon, Macro's & Communications & more! Only \$129 + \$6. All major credit cards. Questions? 805-644-3514. Write for our FREE Catalog of Apple III goodies!
ON THREE, Inc.
4478 Market St. Dept. A, Suite 701
Ventura, CA 93003
Toll Free Order Line 1-800-443-8877

▶HARDWARE/ADD ON BOARDS

B.Y.T.E.'S TRIPLE DECKER

Your Apple IIe deserves what IBM enjoys in color graphics. The Triple Decker provides for the first time 16 Apple colors in 280 X 192 res and 4 colors in 560x192 res with full mixing of 40/80 column text and color graphics you also get plenty of RAM (192K standard to 1 mb), Apple compatibility, Ramdisk and graphics primitive software. Price U.S. \$299. 5/yr warranty—call your dealer or order direct from:
B.Y.T.E.
301 Moodie Drive, Suite 410
Nepean, Ontario, Canada K2H9C4
613-726-9350
(Dealer inquiries welcomed)

FREE DISK NOTCHER, CAT

alog and shipping with order. Our Z80 CP/M card (\$39 no software) gives you access to a vast quantity of software. Our RS232 super serial card (\$69, manual & cable) interfaces with printers, modems, etc. 30 day return. 1 yr warranty. Quality Products! Terrific Prices! Free Expanded Catalog! Order Now!!!!!!
Dasietronics
P.O. BOX 51
Rexford, New York 12148
Ph 518-877-7302

▶HARDWARE/ COMMUNICATIONS

CABLE TV

Jerrold equipment, model numbers DRZIN, DRZD, DRZID, and more. SB-3, Oak VN-12 and M35-B, Zenith Z-Tac, also scientific atlanta models 8500, 8550. All products enable you to pick up most cable stations. Best prices around! For information, send \$1.00 plus SASE or call (312) 434-6788
Swensons Electronics
6839 So. Maplewood
Chicago, IL 60629
NO ILLINOIS ORDERS ACCEPTED

▶HARDWARE/ PERIPHERALS

APPLE IIe COMPATIBLES

Liquidation sale: IIe compatible \$350, Z-80 CP/Mcard \$35, disk drive card (2 drives) \$35, grappler compatible printer card \$35, 80 column/64K card \$40, compatible power supply (5 amp) \$39, serial card \$54, 64K motherboard \$220, many more & 90 day warranty.
J&J International
444 W. Camelback Rd. Suite 304
Phoenix, AZ 85013
(602) 265-9191

MORE THAN A JOYSTICK

State-of-the-art has never performed so well. The GRAVIS MK VI Analog Controller for your Apple.
• Pistol Grip Handle
• 8 Position Tension Control
• 3 Independent Fire Buttons
• 1 Year Warranty
• Available for Macintosh as well.
Only \$49.95 + \$5 S/H. Dealer Inquiries Welcome Chk/M.O.
Gravis Computer Technologies, Inc.
943 Boblett
Blaine, Washington 98230
604 434-7274 ext. 22

MOUSETRACER

Use your Mac, IIe, of IIc mouse and draw like the pros! Put cartoons, pictures, maps, etc. on the drawing board. Strap your mouse to the Mousetracer and with your favorite graphics program trace the picture of your choice. Works like a 1:1 drafting board pantograph. Send \$34.95 + \$3 UPS shipping (CA res add \$2.10 sales tax) to:
BRIMARK INNOVATIONS
9821 Yolanda Ave.
Northridge, CA 91324

▶SOFTWARE/ ACCOUNTING

APPLE IIe VERTICAL MARKET

Video Rental System Hotel/Motel System
Auto Parts Store Point of Sales
Restaurant Payroll Job Costing
Certified Payroll Florist Invoicing
Multi-user systems. Optional bar code reader & cash draw available plus optional integration into a full accounting system.
West Ware Inc.
65 E. 400 South
Orem, UT 84058
(801) 226-8926

▶SOFTWARE/ BUSINESS

HOW-TO BOOK ONLY \$1

VersaForm's 40-page book, "How to use a Database in Business and Accounting" covers invoicing, professional billing, personnel, purchasing, manufacturing parts management, inventory, + mailing lists. Illustrated examples show how to implement these applications on VersaForm or equivalent high-function database. \$1 (\$2 1st class)
Applied Software Technology
Dept. PW. Box 1769
Los Gatos, CA 95031-1769
(408) 370-2662

APPLEWORKS FINANCE FILES

Nineteen Business Finance Files, incl. balance sheet-inventory control-brokeven/price break analysis-EQQ/ROP-queues-depreciation—\$25.95. Thirteen Personal Finance Files, incl. checkbook monthly budget-mortgage-annuity-loan—\$19.95. Excellent detailed book included with each disk. Post paid U.S., CALIF. res. add 6%. Req: Apple II, e.c and Appleworks
Practical Computer Applications
2323 Tucker Ct.
Santa Rosa, CA 95401-2374

▶SOFTWARE/ BUSINESS PROJECT MANAGEMENT

EVERYBODY'S PLANNER

The Planning Tool for the Rest of Us. Project Management & Flowcharts made easy. PERT charts W/54 tasks, critical path, 216 resources, early-late, start & finish dates. 7 reports, optional costing. Infinite Activated flowcharts, 20 shapes-9sises, 3 fonts. 64K Apple, IBM \$99.95+ \$s/h. VISA/ck.
Abracadata, Ltd.
P.O. Box 2352-A
Eugene, OR 97402
503-342-3030

SOFTWARE/ COMMUNICATIONS

APPLE II/MAINFRAME LINK

• True IBM 3780 and/or 3270 emulation. • Error-free bisynchronous data transmission at speeds of 2400-9600 baud. • Ideal for medical claims submission to Blue Cross/Blue Shield. • Approved for direct connection to the IBM Information Networks Insurance Communication Service. • Interfaces to all major IBM operating systems. URGeo SOFTWARE INC.
PO BOX 305
Cheney, WA 99004
509-838-6058

SOFTWARE/ DATA MANAGEMENT

"DATAWORKS"

A series of templates for use in the AppleWorks database. Each yearly file contains month, day, year, day of week and 30 holidays. Years 1986 thru 1997 included. Use as appointment calendar, expense record, daily reminder, family medical record & much more. The power of a database and convenience of "desktop" availability for \$19.95. Add \$2.50 Ship. NYS res. add sales tax. David Sachs Associates
2274 56 Drive
Brooklyn, N.Y. 12234
(718) 531-5737

SOFTWARE/ EDUCATIONAL

GRADE MASTER

Choice of educators everywhere!! A fast efficient "professional" grade management system for K-College teachers. Easy grade entry/change, flexible set-up, professional reports on screen or printer. Brochure, review, and user comments on request. Demo disk \$5. Apple II+/e/c & IBM. \$79+\$4 s/h TX 5.125% tax. VISA MASTERCARD. ENCODE (formerly Micro-Vision)
PO BOX 5070
Klingwood, TX 77325
(713) 358-6687

SOFTWARE/ ENTERTAINMENT

KNIGHTS OF WIZARDRY!

Frustrated? Rookies and skilled players alike win with our system. Fully detailed maps containing all notes and information needed. \$6.00 each scenario. Master manual has secret tricks and step-by-step guidance to conquer all three scenarios, only \$15.00. All for only \$25.00.

MASTER MAZE SYSTEMS
P.O. Box 12867 Dept A+
Gastonia, NC 28053-6867
(704) 866-0579

SOFTWARE/ GENERAL

DESIGN YOUR OWN LABELS!

Use PRO LABEL to design & print multi-purpose labels for office, shop, lab, and home. Name badges, disk labels, parts ID stickers, mail labels, & more. Set size, design label, then print 1 to 1000. Intermix variable and fixed fields & fill in changeable data when printing. Do serial numbers & date stamping. Use our 20 pre-designed formats or make new ones. 100 labels, pgm, manual: \$19.95 + \$1 shpg. 128K IIe/IIc & all printers. Free Fact Sheet.
MICRO DATA SERVICES
P.O. Box 631
Marshalltown, IA 50158
1-800-634-5463, IA 800-542-7981

SOFTWARE/ GRAPHICS

PRINT SHOP USERS CLUB

We help you get the most of Print Shop! The \$30.00 membership fee includes: 1200+ Graphics on 6 disks, a Utilities disk, and one issue of the club newsletter-Update Disk (with articles and 100+ more graphics). Additional 3 issues of the Updated Disk—\$25.00 Send (Check/MO/Visa/MC) or a SASE for graphics list to:
Print Shop Users Club
Box 216
Mercer Island, WA 98040
(206) 232-8272

SOFTWARE/ PERSONAL

KITCHEN PLANNER

Create a 1-14 day Menu and Shopping List in less than 5 min. The only program available which both composes balanced meals and lets you change them! It's also the fastest and easiest to use. Compact, useable printout. To order send \$29.95 + \$1.50 (handling) or call with VISA/MC. All Apple II's. CA add 6 1/2%.
SAV-SOFT PRODUCTS
P.O. Box 24898
San Jose, Calif. 95154
(408) 978-1048

SOFTWARE/ REAL ESTATE

ELECTRONIC HUD SETTLEMENT

Appleworks or Supercalc 3a template calculates cash required from purchaser and cash payable to seller of Real Estate. Sales prices to \$999,000. Prints page 1 & page 2 of HUD form and a cash in and out check. Template requires 128K RAM. RELEASED.7/85... PRICE \$55 Lotus 1-2-3- version \$95.
WEBER ABSTRACT
Suite 820 One Oxford Valley
Langhorne, PA 19047
(215) 750-7550

SOFTWARE/ SCIENTIFIC

STATISTICS CATALOG!

If you need statistics for Apple II, II+, IIe or IIc, call us. Our catalog contains professional programs for: general statistics, high level Anova, multiple regression quality control, and associated graphics. Write or call now for a free catalog of quality statistics software.
HUMAN SYSTEMS DYNAMICS
9010 Reseda Blvd. Suite 222
Northridge, CA 91324
1-800-451-3030, 1-818-993-8536 in CA

SOFTWARE/ SPREADSHEET

APPLEWORKS SUPER GRAB BAG

Why pay more but get less? Get SUPER GRAB BAG of professional-quality AppleWorks or SuperCalc3a spreadsheet templates and forms: Taxes, Buying a House or Income Property, College Fund, Shopping/Camping Lists, Expert System, more. Easy to customize. Save hours, learn techniques. \$12 plus \$2 S/H. WI add 5%.
PETE PETIT/SUPER GRAB BAG
1344 N. 31st St.
Milwaukee, WI 53208
414-933-4627

SOFTWARE/ STATISTICS

ELF. THE STATISTICAL PACKAGE

Interfaces with Visi-Calc files or creates its own. Unlimited observations, 250 variables in database. Factor Analysis, Stepwise Regression, Discriminant Analysis, 1&2 way ANOVA, Crosstabs, Correlations, t-Test, Transformations, more. All New and improved Manual. \$350 + discounts. Call more!
The Winchendon Group, Inc.
P.O. Box 10339
Alexandria, VA 22310
(703) 960-2587

SOFTWARE/ STOCK ANALYSIS

STOCK MARKET STRATEGY

Charts and Reports for up to 50 stocks per disk. When and Amount to Buy or Sell. List and Copy all programs. Manual and 2 Disks \$49.95. Demo Disk \$10.00 Refunded with purchase of program. 1 or 2 Drives. 11, +, C, E. Adaptable to other systems. Copy protection and Customization free on request. Allow 14 days delivery.
R.O. Keen, KeenTECH Software
8340 Addison Dr. S.E.
Calgary T2H 1P1
Alberta, Canada.

SOFTWARE/ STRATEGIC GAMES

SUPER STAR TREK

You've seen it on mainframes! All the thrills of the original Star Trek plus: Romulans equipped with cloaking devices, Klingon Commanders with tractor beams, orbit planets, mine dillithium crystals, launch probes, defend starbases, five levels of play and much more! Not copy protected. Only \$19.95.
SOFTTREK ENTERPRISES
3646 Fieldcrest Drive, Dept A
Garland, TX 75042
(214) 964-0645

WIZARDRY CONSTRUCTION SET

Create deadly dungeons w/magic pools, chutes, elevators, etc. Stock it with vicious beasts, tantalizing treasure chests, magical armour & weapons. Edit items, treasure chests, monsters, "specials", maze levels & more! High quality & arrow key driven. Manual incl. Only \$34.99. For speedy delivery call 1-800-628-2828 ext. 5201, 24 hours every day (VISA/MC accepted) or send check or MO to:
MagicSoft
PO Box 908-A
Danville, CA 94526-0908
(415) 820-0711

NEVER-ENDING DUNGEONS!

Finally, a dungeon exploration game which is always challenging. WARRIOR'S REALM dungeons have up to 99 levels (you set the difficulty factor). 90 different dungeon layouts plus a random dungeon which is always different. Fight off hordes of monsters with swords and magic scrolls in Hi-Res with sound effects. (Apple II+,e,c) Send \$29.95 (check/M.O.) to:
GERHARDT SOFTWARE
32600 CONCORD DRIVE, DEPT 401
MADISON HEIGHTS, MICH 48071

THE ULTIMATE CHALLENGE

Tired of mindless computer video games? In **SPACE PIRATES**, you design and outfit your own ships, search for ore, and bring your feet into battle. **SPACE PIRATES**: the strategy of chess and the excitement of star battle games Apple II 64K, IBM PC w/color. Send \$19.95 + \$2.50 handling to:

Fourfront Technologies, Inc.
160 Quinapoxet Lane
Worcester, MA 01606
(617) 853-3216

BARD'S TALE PLAYERS!

EDITOR and HINTBOOK for Bard's Tale! Editor allows you to change name, class, race, exp. gold. Bring the dead back to life. Put hit and spell points to 65000! Strength to 31! Have warriors cast spells! Hintbook has hints and maps for all dungeons (20 pages). Bard editor \$15.95. Bard Hintbook \$9.95. VISA/MC call. Send CHECK/MO + \$2.00 S/H to:

S&D Software
P.O. Box 223458
Carmel, CA 93922
(408) 649-5592

SOFTWARE/ UTILITIES

FREE PASCAL NEWSLETTER

Interested in Apple Pascal? Send your name and address for a free one year subscription to our newsletter/catalog. Includes tips, news, and information about the world of Apple Pascal. Also included is a catalog of Pascal programs and utilities. Most programs and utilities have an average price of less than \$10 and include full source code.

Palos Computer Concepts
PO Box 560
Palos Park, IL 60464

PFS FILE USERS

The "BRIDGE" gives you the ability to extract data from PFS FILE™ to either an ASCII, text file or a DIF FILE. Extracted data can be used with word processors, spreadsheets, for conversion to other data bases (Appleworks™), or for transmission to other computers. All APPLE II's. To order send \$59.95.

SUN MICROSYSTEMS, INC.
P.O. Box 1388
Ft. Lauderdale, FL 33302
(305) 486-6115

APPLEWORKS ... WITH A MOUSE

APPLEWORKS/MI is a Mouse Interface for Appleworks. It is used instead of the Startup disk, and allows cursor control using the Apple Mouse in the wordprocessor, spreadsheet and database. You can still use the arrow keys, but the mouse is better. Click once for Return, click twice for Escape. What could be easier! Requires Appleworks 1.2, Apple IIc or 128K 2e, and (of course) an Apple Mouse. Only \$25 US. (PQ add 9%)

ECONOTRON SOFTWARE
4164 Henri-Julien
Montreal, PQ., H2W-2K3
CANADA

PRODOS FOR STARFIRES

Attention Corona Starfire users you can now add a ProDos software driver to your Corona Hard Drive. You know how convenient and user-friendly your Corona Hard Disk is. Take advantage of the power of ProDos and the convenience of the Corona Hard Drive. For Apple II+/e w/min 64K. \$49.95+\$3.s/h

Law Industries
3387 W. Corning St.
New Bury Park, CA 91320
(805) 498-8268 (evenings/weekends)

CAPE COD CONVERTIBLE

Converts BASIC programs (end manual edit) APPLESOFT from/to IBM-PC BASIC APPLESOFT from/to APPLE CP/M APPLE CP/M from/to IBM-PC BASIC One-way \$150. Round trip \$225. Other utilities included are: string search, list program variables, text file comparison.

CAPE COD SOFTWARE, INC.
POB 654
North Eastham, MA 02651
(617) 255-9537

USED EQUIPMENT

USED COMPUTER PRODUCTS

National Listing Service. Buy or sell used products directly from 1000 now listed. It's easy. Our Price Estimating and Mailing services can help you. **SAVE MONEY.** Is it worth paying more for new? **NO CHARGE** for Buying. **NO RISK** for Sellers—6% fee when sold (\$20 min., 3% over \$5000). Any product over \$100. Use a touch-tone phone if you can. If you do, we are open 24 hours every day.

Comp-Used
203-762-8677

When you have questions or problems about your Apple II or Macintosh or a specific application, write to A+'s monthly column, "Rescue Squad" and get an answer from the experts—the editors of A+ Magazine!

ADVERTISING RATES AND INFORMATION

Standard listings consist of a bold lead line (25 characters maximum); 7 lines of body copy (45 characters per line); 4 lines for company name, address and telephone number. \$180 per insertion—3 issues minimum. Additional charge for extra lines and company logos. Prepayment and frequency discounts available. American Express, MasterCard, Visa accepted. Copy subject to publishers approval. Send typewritten or printed copy, reproducible logo art (if applicable) and remittance to Kathryn Cumberlander, Classified Sales Manager, Ziff-Davis Publishing Company, One Park Avenue, New York, NY 10016. For additional information, assistance, or to place an order by phone, call collect (212) 503-5115.

► PUBLICATIONS/ CATALOGS

MACINTOSH BOOKS:

*Basic Microsoft Basic \$16.95
 *Introduction to Macintosh Pascal \$18.95
 *JAZZ on the Macintosh \$20.95
 *Macintosh Multiplan \$15.95
 *Programming the Mac in Assembly Language \$19.95
 *The Macintosh Basic Handbook \$21.95
 *1001 Things to Do With Your Macintosh \$8.95
 Ship/hnd. extra. MC/VISA/AE.
 FREE Directory of over 450 Mac/Apple titles.
 MICRO BOOKS, P.O. Box 4068, W. Richland, WA 99352
 800/547-9755 Ext. 8 or 509-967-5084

► SOFTWARE/ ACCOUNTING

REALWORLD ACCOUNTING

512K Macintosh; Hard disk drive, includes Accounts Payable, Accounts Receivable, General Ledger, Payroll, Inventory Control, Order Entry/Billing, and Sales Analysis. \$745 retail; each module. \$445 retail; Sales Analysis.
 R.M.A.
 11333 N. Central Suite 219
 Dallas, TX 75243
 214-739-5451

► SOFTWARE/ ENGINEERING

STRUCTURAL ENGINEERING

FRAME-MAC (\$495) for 2D frame analysis & dsn. (with MacDraw-like intrfc.). BEAMAC II (\$295) for continuous beam anal. & design. BEAMAC (\$95) for simple beam anal. Any demo for \$10. Any # of nodes, section table on disk (except BEAMAC). Any # of loads of any static type. Various dgm. & text windows. Full Mac intrfc. \$-back guarantee. Info and support are free.
 Erez Anzel
 5800 Arlington Avenue #5T
 Riverdale, NY 10471
 (212) 884-5798

► SOFTWARE/ FINANCIAL

TECHNICAL ANALYSIS

PROFIT STALKER II integrated data base/charting/terminal emulation program for analysis of stock and commodity price movement. Bar & line charts include daily, volume, open interest, on-balance volume, moving averages, oscillators, & many others including point-and-figure, & spread tracking. Automatic download. For MAC 512K & Lgr. \$250. Info available.
 Dept AA Button-down Software
 PO Box 19493
 San Diego, CA 92119
 (619) 463-7474

► SOFTWARE/ GENERAL

FLUENT FONTS™

Fluent Fonts is a collection of 48 text, graphic, & symbol fonts on 2 disks, ready to use w/any Mac Program which uses fonts. All Western & most Eastern European languages can be used in Documents w/scientific & technical symbols. Optimized for high quality Image Writer & Laser Writer Output. \$49.95 + \$3.00 US Ship.
 CASADY COMPANY
 P.O. Box 223779
 Carmel, CA 93922
 (408) 646-4660

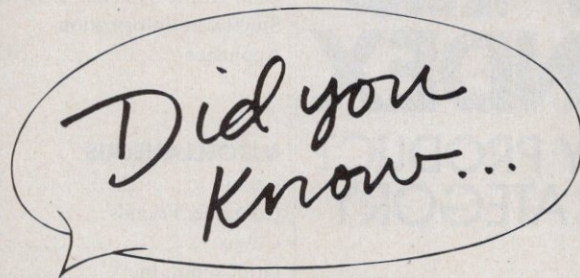

that A+ readers are more responsive than other Apple owners? Every month, you generate over 122,000 requests for product information. Products you read about or see advertised in A+!

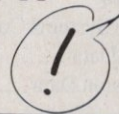

For Free Information...

...on any product you see advertised or read about in A+ Magazine, look for the Reader Service Number and mark it on the Reader Service Card found in the back of this issue. The manufacturer will send you additional information free!

AD INDEX

BY PRODUCT CATEGORY

ACCESSORIES

	PAGE
CARRYING CASES	
Cabbage Cases	95
Fiberbilt	59
Shanner International	33

DISKS

BASF Systems Corp	26,27
Echo Data	103
Precision Data	144
TDK	69

MISCELLANEOUS

Cheatsheet Products, Inc. ...	115
Computer Cover Co.	97
Eastern Software Distributors	55
Nikrom	80
Norwich Data Services	135

BOOKS

	PAGE
Bristen Press	135

HARDWARE

	PAGE
DIGITIZERS	
Digital Vision	16

DISK DRIVES/STORAGE DEVICES

First Class Peripherals	75
Space Coast Systems	135

INTERFACE CARDS

Applied Engineering	10,
34,35,47,53,83,115,123,	
125,127,134	

	PAGE
AST Research	2, 3
Legend Industries	114
Levco	105
Ohio-Kache Systems	28
Swyftware/Information Appliance	126

MISCELLANEOUS

Cauzin	63
Computer Friends	38
Covox	74
GridComm, Inc.	19
Innovative Micro	144
Kensington Microware	C4
ProApp	17
Roger Coats	45
Quorum	131
Videx	62

MODEMS

Hayes Microcomputer Products	128
Coit Valley	76,77

PRINTERS/PRINTER ACCESSORIES

Dresselhaus	90
Orange Micro	37
Texprint	89
Thirdwave Technology	88

MAIL ORDER

	PAGE
Business Computers of Peterborough	86
CDA Computer Sales	60
Coit Valley	76,77
Computer Network	64
Conroy-LaPointe	52
Jameco	91
JDR	79
Northeastern Software ..	70, 71,
108, 109	
PC Network	100, 101
Pro/Pac	80
Programs Plus	40,41
Ribbon Land	32
Silicon Express	85
Unitech	61
Zimco	119

SOFTWARE

BUSINESS

	PAGE
Abacus	130
H & E Computronics	C2
Pinpoint Publishing	131
Public Domain Exchange ..	66
Writing Software	44

COMMUNICATIONS

Meacom International	126
Russ Systems	126

DATA MANAGEMENT

PM Software	46
Statsoft	74

DEVELOPMENT SYSTEMS

Expertelligence	92
Manx	106

EDUCATIONAL

HesWare	117
Springboard	1

ENTERTAINMENT/STRATEGY

Activision	5
Electronic Arts	8
Interlude	81
Professor Jones	116
Sublogic	4

GRAPHICS

Diehl Graphsoft	103
T & W Systems	90
Spectral Graphics Software ..	14

MISCELLANEOUS

Bible Research	95
Future Music	84
Interactive Microware	16
Megahaus	21
Rocky Mountain Medical	36
Rolodex	25

	PAGE
Softbyte	116
Uptime	12

ON-LINE SERVICES

Compuserve	13
General Electric Information Service (GENIE)	72
Grolier	29

PERSONAL BUSINESS-HOME

Chase Manhattan	38
HowardSoft	C3
Intuit	132

UTILITIES

Beagle Brothers	78
Central Point Software	66
Utilico	111

WORD PROCESSING/SPELLING CHECKERS

Sensible Software	54,82
Styleware	39

ALPHABETICAL AD INDEX

READER SERVICE NO. PAGE

A

- 114 Abacus Systems 130
 174 Activision, Inc. 5
 * Applied Engineering....10
 * Applied Engineering....47
 * Applied Engineering34,35
 * Applied Engineering....53
 * Applied Engineering.. 123
 * Applied Engineering.. 125
 * Applied Engineering.. 127
 * Applied Engineering....83
 * Applied Engineering.. 134
 * Applied Engineering.. 115
 323 AST Research, Inc.2,3

B

- 157 BASF Systems Corp.26,27
 148 Beagle Brothers78
 158 Bible Research Systems.....95
 166 Bristen Press 135
 * Business Computers of Peterborough86

C

- 141 CDA Computer Sales...60
 213 Cabbage Cases95
 120 Cauzin Systems63
 184 Central Point Software .66
 * Chase Manhattan.....38
 * Cheatsheet Products, Inc. 115
 105 Coit Valley Computers .77
 104 Coit Valley Computers .76
 271 CompuServe13
 136 Computer Cover Co.97
 195 Computer Friends38
 137 Computer Network64
 129 Conroy-LaPointe, Inc. .52
 * Covox, Inc.74

D

- 331 Diehl Graphsoft, Inc.. 103
 170 Digital Vision.....16

READER SERVICE NO. PAGE

- 339 Dresselhaus Computer Products90

E

- 309 Eastern Software Distributors55
 123 Echo Data Services, Inc. 103
 168 Electronic Arts 8
 278 Expertelligence.....92

F

- 164 Fiberbilt59
 154 First Class Peripherals75
 338 Future Music.....84

G

- * General Electric Information Service.....72
 199 GridComm, Inc.19
 169 Grolier Electronic Publishing, Inc.29

H

- 296 Hayes Microcomputer Products, Inc. 128
 * H&E Computronics Inc.Cover 2
 * HowardSoft.....Cover 3
 147 HesWare 117

I

- 153 Innovative Micro 144
 324 Interactive Microware ..16
 177 Interlude.....81
 108 Intuit 132

J

- 279 Jameco Electronics91
 167 JDR Microdevices79

READER SERVICE NO. PAGE

K

- 134 Kensington Microware ..Cover 4

L

- 287 Legend Industries, Ltd. 114
 212 Levco 105

M

- 189 Manx Software Systems..... 106
 171 Meacom International 126
 260 Megahaus Corporation .21

N

- 329 Nikrom80
 304 Northeastern Software.....70,71
 330 Northeastern Software.....108,109
 101 Norwich Data Services 135

O

- 178 Ohio Kache Systems Co.28
 258 Orange Micro.....37

P

- 315 PC Network100,101
 152 Pinpoint Publishing ... 131
 150 PM Software.....46
 228 Precision Data Products 144
 175 ProAPP, Inc.17
 132 Professor Jones 116
 299 Programs Plus40,41
 172 Pro/Pac80
 256 Public Domain Exchange.....66

Q

- 223 Quorum International. 131

READER SERVICE NO. PAGE

R

- 202 Ribbon Land32
 239 Rocky Mountain Medical.....36
 109 Roger Coats45
 182 Rolodex Corp.25
 344 Russ Systems 126

S

- 106 Sensible Software54
 227 Sensible Software82
 116 Shanner International...33
 231 Silicon Express85
 200 Soft Byte 116
 135 Space Coast Systems..... 135
 139 Spectral Graphics Software14
 261 Springboard Software ... 1
 207 Statsoft74
 155 Styleware.....39
 110 Sublogic 4
 * Swyftware/Information Appliance 126

T

- 173 TDK Electronics69
 102 T&W Systems90
 343 Texprint89
 145 Third Wave Technology88

U

- 160 Unitech61
 219 Uptime, Inc.12
 190 Utilico 111

V

- 142 Videx, Inc.62

W

- 235 Writing Software International44

Z

- 143 Zimco 119

pd
Precision Data Products
 Complete Line of Quality Supplies for Your Computer

TOLL FREE ORDER LINE
800-258-0028

FOR INFORMATION CALL
616-452-3457

INTRODUCING

STATE-OF-THE-ART MAGNETIC MEDIA
 RIGOROUS QUALITY CHECKS ENSURE THEIR RELIABILITY

FROM ONE OF THE LEADING MAGNETIC MANUFACTURERS IN THE WORLD

5 1/4" DISKETTES

- With Hub Rings
- With Write Protect Tabs
- With Static-Free, Dust-Free Envelopes
- With User ID Labels
- In Factory Sealed Poly Packs

(YOU GET EVERYTHING BUT THE BOX) — PRICES ARE PER DISK

QTY.	50	100	500	1000
SSDD	.59	.53	.50	.47
DSDD	.62	.58	.55	.52

wabash 3 1/2" DISKETTES

25/POLY PACK

Single Side HD 135TPI . . . \$1.40 ea. Double Side HD 135TPI . . . \$1.65 ea.
 INDIVIDUALLY CERTIFIED 100% ERROR FREE • COVERED BY A FULL LIFETIME WARRANTY
 (MEET OR EXCEED APPLICABLE ANSI, ECMA, ISO STANDARDS)

DISK HOLDER 3.5 Holds 40 diskettes . . . \$8.50 (delivered price)

PRINTER RIBBONS

Quality replacements for most popular printers

Apple Imagewriter . . . \$3.95 ea. Okidata 80/82/83 . . . \$1.75 ea.
 Apple Scribe . . . \$2.95 ea. Toshiba 1350 . . . \$4.89 ea.
 Epson LX 80/90 . . . \$2.95 ea. Minimum: 6 ribbons

Minimum order: \$25.00. Add 10% for less than 50 diskettes. **Shipping and Handling:** \$4.00 per 100 diskettes. Continental U.S.A. APO/FPO, add \$8.00 per 100 diskettes. Reduced shipping charge for larger quantities. C.O.D. add \$4.00. Cash or certified check. MI residents add 4% sales tax. Prices subject to change without notice. HOURS: 8:30 AM - 6:00 PM Eastern Time.



Precision Data Products

P.O. Box 8367, Grand Rapids, MI 49518
 (616) 452-3457 • Michigan 1-800-632-2468
 Outside Michigan 1-800-258-0028



C.O.D.

CIRCLE 228 ON READER SERVICE CARD

**Update your IIe
 for under
 \$100**

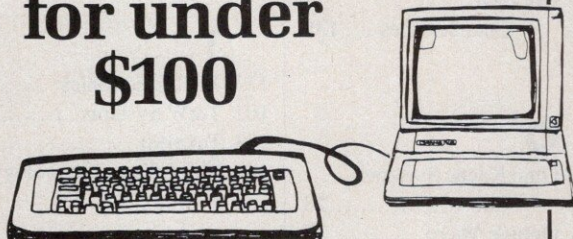

Includes: cover plate, new keyboard enclosure, cable, mounting hardware and complete easy-to-follow instructions.

Name _____

Address _____

City _____ State _____ Zip _____

Send check or money order for \$99 (we pay shipping charges) or:

Credit card purchase — \$104 includes shipping.

Visa MasterCard
 Acct. # _____

Signature _____ Exp. Date _____

California Residents add 6% sales tax.



INNOVATIVE MICRO, INC.

Systems Wholesaler (714) 661-0435
 34732 Calle Fortuna, Capistrano Beach, CA 92624

CIRCLE 153 ON READER SERVICE CARD

Coming  Soon

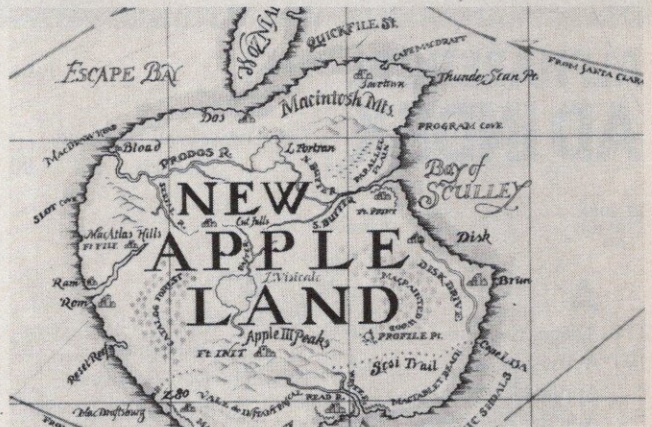

Map-Making Macintosh Software

Authoring Systems for Education

Care and Feeding of Diskettes

Public-Domain Software for the Apple II

Apple Writer II for Form Letters and Envelopes

Apple II Financial Programs from Sylvia Porter
 and Andrew Tobias

ComputerEyes Digitizer

Reviews:

U.S.A.A.F.

Adventure Construction Set

A Mind Forever Voyaging

Moebius

Entertainment Classics

Macintosh Coverage:

First Look at an Important New Macintosh
 Software Product

Customizing Your Electronic Workplace

68000 Assembly Language Programming, Part III

READER SERVICE CARD

Use this card to get more information about advertised products.



Apple II/Macintosh
THE INDEPENDENT GUIDE TO APPLE COMPUTING

Void after September 30, 1986

101	102	103	104	105	106	107	108	109	110	111	112	113	114	115	116	117	118	119	120	121	122	123	124	125	126	127	128	129	130
131	132	133	134	135	136	137	138	139	140	141	142	143	144	145	146	147	148	149	150	151	152	153	154	155	156	157	158	159	160
161	162	163	164	165	166	167	168	169	170	171	172	173	174	175	176	177	178	179	180	181	182	183	184	185	186	187	188	189	190
191	192	193	194	195	196	197	198	199	200	201	202	203	204	205	206	207	208	209	210	211	212	213	214	215	216	217	218	219	220
221	222	223	224	225	226	227	228	229	230	231	232	233	234	235	236	237	238	239	240	241	242	243	244	245	246	247	248	249	250
251	252	253	254	255	256	257	258	259	260	261	262	263	264	265	266	267	268	269	270	271	272	273	274	275	276	277	278	279	280
281	282	283	284	285	286	287	288	289	290	291	292	293	294	295	296	297	298	299	300	301	302	303	304	305	306	307	308	309	310
311	312	313	314	315	316	317	318	319	320	321	322	323	324	325	326	327	328	329	330	331	332	333	334	335	336	337	338	339	340
341	342	343	344	345	346	347	348	349	350	351	352	353	354	355	356	357	358	359	360	361	362	363	364	365	366	367	368	369	370
371	372	373	374	375	376	377	378	379	380	381	382	383	384	385	386	387	388	389	390	391	392	393	394	395	396	397	398	399	400
401	402	403	404	405	406	407	408	409	410	411	412	413	414	415	416	417	418	419	420	421	422	423	424	425	426	427	428	429	430
431	432	433	434	435	436	437	438	439	440	441	442	443	444	445	446	447	448	449	450	451	452	453	454	455	456	457	458	459	460
461	462	463	464	465	466	467	468	469	470	471	472	473	474	475	476	477	478	479	480	481	482	483	484	485	486	487	488	489	490
491	492	493	494	495	496	497	498	499	500	501	502	503	504	505	506	507	508	509	510	511	512	513	514	515	516	517	518	519	520
521	522	523	524	525	526	527	528	529	530	531	532	533	534	535	536	537	538	539	540	541	542	543	544	545	546	547	548	549	550
551	552	553	554	555	556	557	558	559	560	561	562	563	564	565	566	567	568	569	570	571	572	573	574	575	576	577	578	579	580
581	582	583	584	585	586	587	588	589	590	591	592	593	594	595	596	597	598	599	600	601	602	603	604	605	606	607	608	609	610
611	612	613	614	615	616	617	618	619	620	621	622	623	624	625	626	627	628	629	630	631	632	633	634	635	636	637	638	639	640

Please indicate which of the following microcomputers you currently own and/or plan to buy in the next 6 months.

	(1.) Own	(2.) Plan to Buy
Apple II	A	H
Apple II+	B	I
Apple IIe	C	J
Apple IIc	D	K
Macintosh	E	L
Other (specify)	F	M
None	G	N

Please indicate which of the following peripherals you plan to buy in the next 6 months. Then, for each one that you plan to buy, please indicate when this purchase will most likely be made.

	(3.) Plan to Buy	(4.) 1-3 Months	(5.) 4-6 Months
Printer	O	U	1
Modem	P	V	2
Disk Drive—Hard	Q	W	3
Disk Drive—Floppy	R	X	4
Monitor—Black & White	S	Y	5
Monitor—Color	T	Z	6

PLEASE PRINT CLEARLY—Use only one card per person

Name _____ Phone No. (_____) _____
 Company _____ Title _____
 Address _____ Apt. _____
 City _____ State _____ Zip _____
 (Zip code must be included to insure delivery)

4. Please send me one year (12 issues) of A+ for \$19.97 and bill me—I'll save 44% off the single copy price!

A + 7862

READER SERVICE CARD

Use this card to get more information about advertised products.



Apple II/Macintosh
THE INDEPENDENT GUIDE TO APPLE COMPUTING

Void after September 30, 1986

101	102	103	104	105	106	107	108	109	110	111	112	113	114	115	116	117	118	119	120	121	122	123	124	125	126	127	128	129	130
131	132	133	134	135	136	137	138	139	140	141	142	143	144	145	146	147	148	149	150	151	152	153	154	155	156	157	158	159	160
161	162	163	164	165	166	167	168	169	170	171	172	173	174	175	176	177	178	179	180	181	182	183	184	185	186	187	188	189	190
191	192	193	194	195	196	197	198	199	200	201	202	203	204	205	206	207	208	209	210	211	212	213	214	215	216	217	218	219	220
221	222	223	224	225	226	227	228	229	230	231	232	233	234	235	236	237	238	239	240	241	242	243	244	245	246	247	248	249	250
251	252	253	254	255	256	257	258	259	260	261	262	263	264	265	266	267	268	269	270	271	272	273	274	275	276	277	278	279	280
281	282	283	284	285	286	287	288	289	290	291	292	293	294	295	296	297	298	299	300	301	302	303	304	305	306	307	308	309	310
311	312	313	314	315	316	317	318	319	320	321	322	323	324	325	326	327	328	329	330	331	332	333	334	335	336	337	338	339	340
341	342	343	344	345	346	347	348	349	350	351	352	353	354	355	356	357	358	359	360	361	362	363	364	365	366	367	368	369	370
371	372	373	374	375	376	377	378	379	380	381	382	383	384	385	386	387	388	389	390	391	392	393	394	395	396	397	398	399	400
401	402	403	404	405	406	407	408	409	410	411	412	413	414	415	416	417	418	419	420	421	422	423	424	425	426	427	428	429	430
431	432	433	434	435	436	437	438	439	440	441	442	443	444	445	446	447	448	449	450	451	452	453	454	455	456	457	458	459	460
461	462	463	464	465	466	467	468	469	470	471	472	473	474	475	476	477	478	479	480	481	482	483	484	485	486	487	488	489	490
491	492	493	494	495	496	497	498	499	500	501	502	503	504	505	506	507	508	509	510	511	512	513	514	515	516	517	518	519	520
521	522	523	524	525	526	527	528	529	530	531	532	533	534	535	536	537	538	539	540	541	542	543	544	545	546	547	548	549	550
551	552	553	554	555	556	557	558	559	560	561	562	563	564	565	566	567	568	569	570	571	572	573	574	575	576	577	578	579	580
581	582	583	584	585	586	587	588	589	590	591	592	593	594	595	596	597	598	599	600	601	602	603	604	605	606	607	608	609	610
611	612	613	614	615	616	617	618	619	620	621	622	623	624	625	626	627	628	629	630	631	632	633	634	635	636	637	638	639	640

Please indicate which of the following microcomputers you currently own and/or plan to buy in the next 6 months.

	(1.) Own	(2.) Plan to Buy
Apple II	A	H
Apple II+	B	I
Apple IIe	C	J
Apple IIc	D	K
Macintosh	E	L
Other (specify)	F	M
None	G	N

Please indicate which of the following peripherals you plan to buy in the next 6 months. Then, for each one that you plan to buy, please indicate when this purchase will most likely be made.

	(3.) Plan to Buy	(4.) 1-3 Months	(5.) 4-6 Months
Printer	O	U	1
Modem	P	V	2
Disk Drive—Hard	Q	W	3
Disk Drive—Floppy	R	X	4
Monitor—Black & White	S	Y	5
Monitor—Color	T	Z	6

PLEASE PRINT CLEARLY—Use only one card per person

Name _____ Phone No. (_____) _____
 Company _____ Title _____
 Address _____ Apt. _____
 City _____ State _____ Zip _____
 (Zip code must be included to insure delivery)

4. Please send me one year (12 issues) of A+ for \$19.97 and bill me—I'll save 44% off the single copy price!

A + 7861

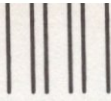

NO POSTAGE
NECESSARY
IF MAILED
IN THE
UNITED STATES

BUSINESS REPLY MAIL

FIRST CLASS PERMIT NO. 27346 PHILADELPHIA, PA

POSTAGE WILL BE PAID BY ADDRESSEE



Apple II/Macintosh
THE #1 INDEPENDENT GUIDE TO APPLE COMPUTING

P.O. Box 40317
Philadelphia, PA 19106-9931

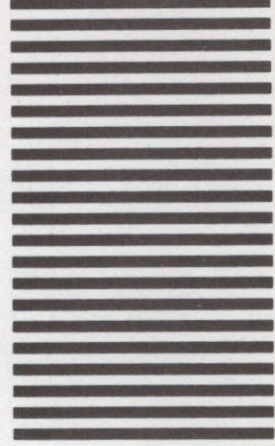

NO POSTAGE
NECESSARY
IF MAILED
IN THE
UNITED STATES

BUSINESS REPLY MAIL

FIRST CLASS PERMIT NO. 27346 PHILADELPHIA, PA

POSTAGE WILL BE PAID BY ADDRESSEE



Apple II/Macintosh
THE #1 INDEPENDENT GUIDE TO APPLE COMPUTING

P.O. Box 40317
Philadelphia, PA 19106-9931

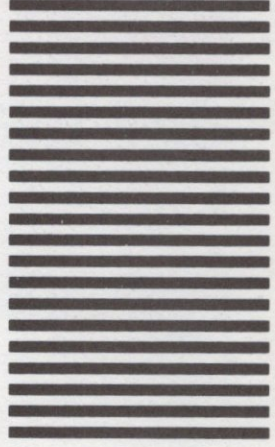

The Intelligent Decisionmakers

As an investor, your decisions depend on accurate, timely information.

The problem is that most of today's investment tools are based on outdated "guidelines" and unrealistic rules, so they can't give you the quality analyses you need to make intelligent decisions.

At HowardSoft®, we create software that's appreciated by both the inexperienced user and the seasoned pro. Real tools for real decisions.

Real Estate Analyzer®

There's a terrific piece of property you'd like to get involved with. But what happens if interest rates rise, rents fall, inflation soars? HowardSoft's Real Estate Analyzer tells you with realistic projections under today's conditions.

Because HowardSoft knows taxes, your after-tax analyses of cash flow and profitability are based on real tax laws, not outdated rules.

And you don't have to be a computer whiz or a real estate expert to use Real Estate Analyzer. Well-planned menus, clear prompts, and a manual filled with examples help you get the most from the program (and your investment) and make it a veritable education in investment analysis.

Tax Preparer®

Your taxes affect every financial decision

you'll make this year. With Tax Preparer you can produce complete returns for filing with the IRS, and even organize your data for next year to make intelligent tax planning decisions. You enter information as it accumulates. Then each update lets you apply the data to the new tax forms in a matter of minutes.

Tax Preparer handles changes easily, calculates quickly and accurately, and — at the touch of a key — delivers error-free printouts ready to sign and drop in the mail. With crystal clear instructions, and the most used forms and schedules, no wonder Tax Preparer is the #1 selling tax program.

Intelligent Software

Both packages help make running your finances easier and more effective. Each works with either the Apple II series, the IBM-PC, or a select range of PC compatibles. Each does the work of software costing many times its price. And each leads the field in accuracy of information and ease of use.

Real Estate Analyzer and Tax Preparer.

Intelligent investment for intelligent investors. Available at your dealer now.

HowardSoft.®
The software investment
you can count on.



1224 Prospect Street, Suite 150
La Jolla, CA 92037 • (619) 454-0121

Now available
for the Macintosh™
System Saver Mac!
Call for details.

MORE THAN 1/4 MILLION APPLE II'S SAVED

SYSTEM SAVER® from Kensington Microware quietly protects more than 1/4 million Apple® II's every day. Often referred to as "the piece Apple forgot," System Saver's unique combination of features have made it the most versatile, most convenient, best selling accessory ever made for the Apple.

System Saver organizes your power needs.

To make your Apple system more convenient, System Saver provides extra outlets for your monitor and printer, while replacing the Apple's power cord. One front-mounted power switch controls your whole system.

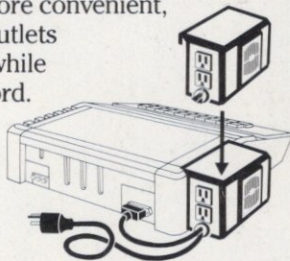

System Saver solves power line problems.

Impurities in the power supply cause 70-90% of all microcomputer malfunctions. Line noise can be interpreted as data, confusing your Apple and causing annoying system errors. Power surges and spikes can do costly damage to your computer's delicate circuitry.

System Saver clips surges and spikes at a safe level and filters out line noise. It makes your Apple more accurate, more efficient and more reliable.

System Saver keeps your Apple cool.

Peripheral cards added to your Apple not only generate heat, they block any natural air flow through the computer. The resulting high temperature conditions can potentially shorten the lives of both your Apple and your peripheral cards.



System Saver's quiet fan draws a breath of fresh air across the Apple's mother board, over the power supply and out the side ventilation slots at the rate of 17 cubic feet per minute.

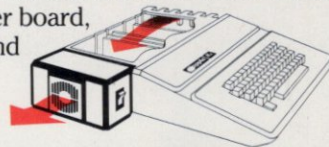

More than 1/4 million Apple owners think of System Saver as the piece Apple forgot. And 1/4 million well-protected Apples agree.

For a dealer near you, or to speak to a Kensington sales representative, call toll free (800) 535-4242
In NY (212) 475-5200.

KENSINGTON™ ◀

CIRCLE 134 ON READER SERVICE CARD