

\$2.95

A

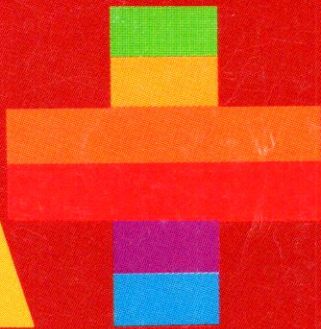

AUGUST 1985

VOLUME 3
ISSUE 8

Macintosh COVERAGE

VIDEOWORKS

THUNDERSCAN

PUBLIC-DOMAIN SOFTWARE

MACPAINT TIPS

THE INDEPENDENT GUIDE
FOR **APPLE** COMPUTING

Downloaded from www.Apple2Online.com

DOT MATRIX

**LEISUREWARE:
SUMMER
APPLICATIONS**

**POSTSCRIPT
TUTORIAL**

**UNDERSTANDING
ProDOS**

**ENTERTAINMENT:
SUSPECT
MACVEGAS
TYPING INTRIGUE
KAMPFGRUPPE
PLATO'S CAVE**

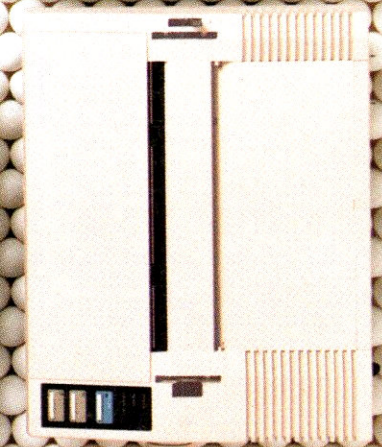
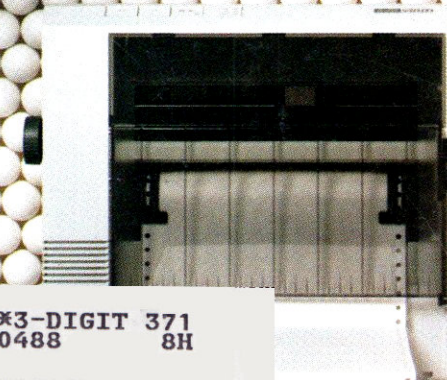
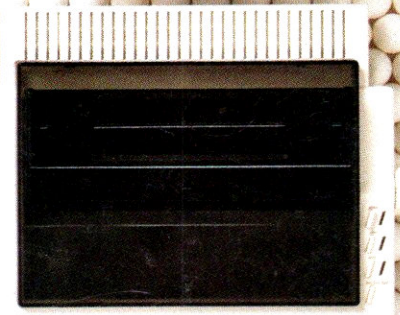
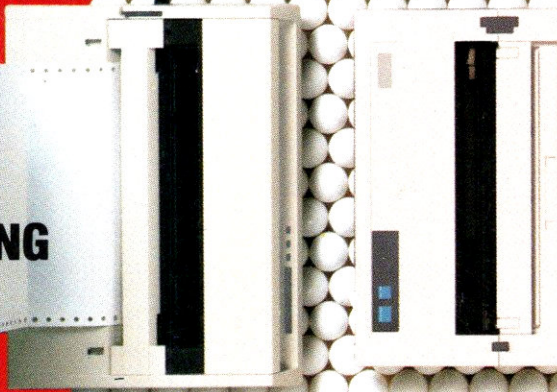
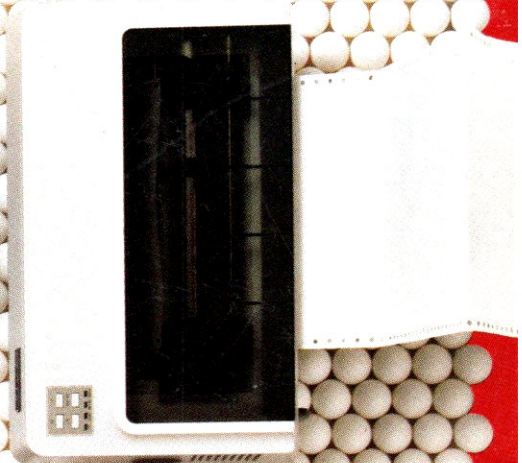

*****3-DIGIT 371
#GAS0116S091 8#680488 8H

DR KENNETH BUCHHOLZ
WWW.APPLE2ONLINE.COM



71486

Introducing the Most Powerful Business Software Ever!

TRS-80™ (Model I, II, III, or 16) • APPLE™ • IBM™ • OSBORNE™ • CP/M™ • XEROX™

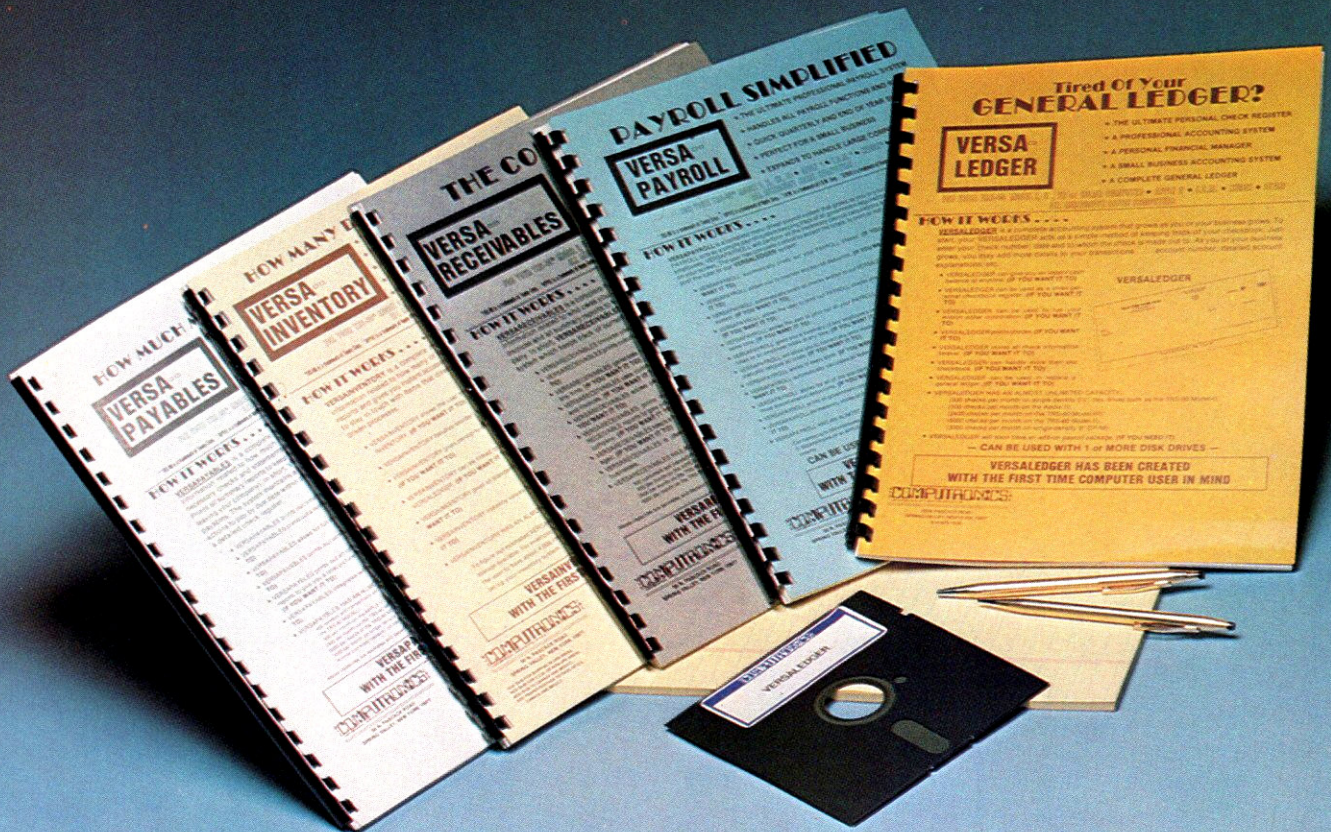

The VERSABUSINESS™ Series

Each VERSABUSINESS module can be purchased and used independently, or can be linked in any combination to form a complete, coordinated business system.

VERSARECEIVABLES™

\$99.95

VERSARECEIVABLES™ is a complete menu-driven accounts receivable, invoicing, and monthly statement-generating system. It keeps track of all information related to who owes you or your company money, and can provide automatic billing for past due accounts. VERSARECEIVABLES™ prints all necessary statements, invoices, and summary reports and can be linked with VERSALEDGER II™ and VERSAINVENTORY™.

VERSAPAYABLES™

\$99.95

VERSAPAYABLES™ is designed to keep track of current and aged payables, keeping you in touch with all information regarding how much money your company owes, and to whom. VERSAPAYABLES™ maintains a complete record on each vendor, prints checks, check registers, vouchers, transaction reports, aged payables reports, vendor reports, and more. With VERSAPAYABLES™, you can even let your computer automatically select which vouchers are to be paid.

VERSAPAYROLL™

\$99.95

VERSAPAYROLL™ is a powerful and sophisticated, but easy to use payroll system that keeps track of all government-required payroll information. Complete employee records are maintained, and all necessary payroll calculations are performed automatically, with totals displayed on screen for operator approval. A payroll can be run totally, automatically, or the operator can intervene to prevent a check from being printed, or to alter information on it. If desired, totals may be posted to the VERSALEDGER II™ system.

VERSAINVENTORY™

\$99.95

VERSAINVENTORY™ is a complete inventory control system that gives you instant access to data on any item. VERSAINVENTORY™ keeps track of all information related to what items are in stock, out of stock, on backorder, etc., stores sales and pricing data, alerts you when an item falls below a preset reorder point, and allows you to enter and print invoices directly or to link with the VERSARECEIVABLES™ system. VERSAINVENTORY™ prints all needed inventory listings, reports of items below reorder point, inventory value reports, period and year-to-date sales reports, price lists, inventory checklists, etc.

VERSALEDGER II™

\$149.95

VERSALEDGER II™ is a complete accounting system that grows as your business grows. VERSALEDGER II™ can be used as a simple personal checkbook register, expanded to a small business bookkeeping system or developed into a large corporate general ledger system **without any additional software.**

- VERSALEDGER II™ gives you almost unlimited storage capacity (300 to 10,000 entries per month, depending on the system),
- stores all check and general ledger information forever,
- prints tractor-feed checks,
- handles multiple checkbooks and general ledgers,
- prints 17 customized accounting reports including check registers, balance sheets, income statements, transaction reports, account listings, etc.

VERSALEDGER II™ comes with a professionally-written 160 page manual designed for first-time users. The VERSALEDGER II™ manual will help you become quickly familiar with VERSALEDGER II™, using complete sample data files supplied on diskette and more than 50 pages of sample printouts.

SATISFACTION GUARANTEED!

Every VERSABUSINESS™ module is guaranteed to outperform all other competitive systems, and at a fraction of their cost. If you are not satisfied with any VERSABUSINESS™ module, you may return it within 30 days for a refund. Manuals for any VERSABUSINESS™ module may be purchased for \$25 each, credited toward a later purchase of that module.

To Order:

**Write or call Toll-free (800) 431-2818
(N.Y.S. residents call 914-425-1535)**

- * add \$3 for shipping in UPS areas
- * add \$4 for C.O.D. or non-UPS areas

- * add \$5 to CANADA or MEXICO
- * add proper postage elsewhere

DEALER INQUIRIES WELCOME

All prices and specifications subject to change / Delivery subject to availability.

COMPUTRONICS

50 N. PASCACK ROAD, SPRING VALLEY, N.Y. 10977

* TRS-80 is a trademark of the Radio Shack Division of Tandy Corp. * APPLE is a trademark of Apple Corp. * IBM is a trademark of IBM Corp. * OSBORNE is a trademark of Osborne Corp.

BEST COLOR TALENT IN THE SCREEN BUSINESS

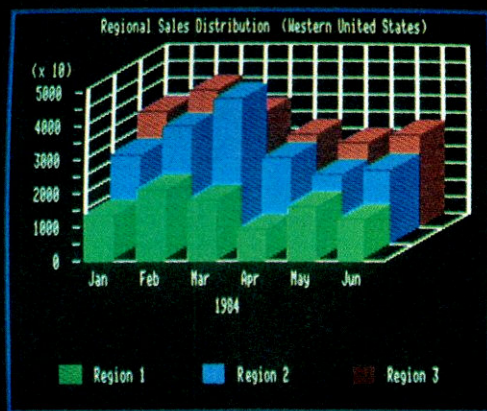

video7

video7

Critics' Choice

The favored nominee for "Best Color on any Apple™ II Screen": Professional Color™ from Video 7™!

The name of the technology is "RGB," the highest standard in computer color.*

Professional Color, and the "Big Screen," too

Playing the dual role of "RGB" and "80-column text," Professional Color gives screen performance that's especially vivid and alive.

An Original Screenplay

Video 7 is the author of Apple's own RGB interface. So for Professional Color on your Apple II screen, get a V-Color™ card from Video 7. Call (800) 238-0101 (In California, (408) 943-0101) for the dealer nearest you.



*"RGB" (red, green, blue) is also the color standard of the IBM PC. Apple is a registered trademark of Apple Computer, Inc. V-Color, Video 7 and Professional Color are trademarks of Video 7, Inc.

CIRCLE 195 ON READER SERVICE CARD



Downloaded from www.Apple2Online.com



THE INDEPENDENT
GUIDE FOR
APPLE COMPUTING

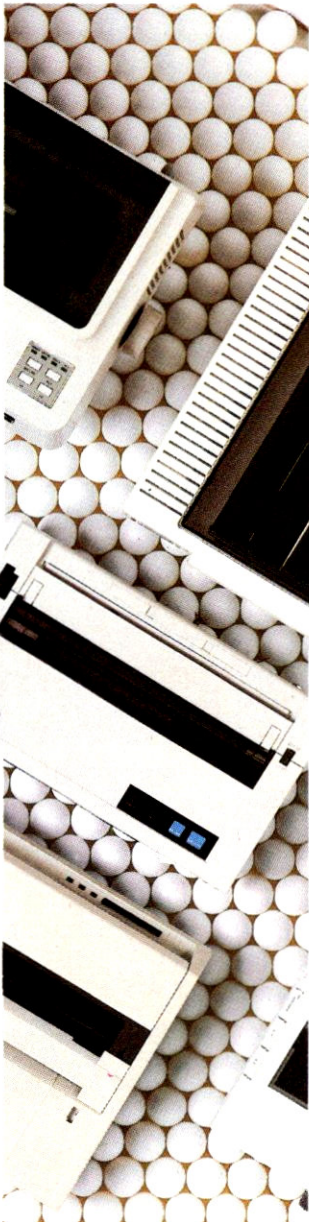

PAGE 26

COVER STORY

**26
DOT-MATRIX
PRINTERS = LOW COST,
SPEED, AND FLEXIBILITY**

By David Townsley and
Francesca Venning-Townsley

If you can afford only one all-purpose printer for your Apple, it's a sure bet that you're in the market for a dot-matrix printer. This article reviews a sample of available dot-matrix printers—14 impact printers and one thermal-transfer printer.

PAGE 38

SOFTWARE

**38
LEISUREWARE**

By John Barry

Summer is here, and it's time to put away those complex packages for awhile. The word among the software-fashion-conscious this season is "leisureware." And when it comes to leisureware, designers seem to have something for just about every Apple II user.

HARDWARE

**45
A CLOSE LOOK AT
RECENT IIe
ENHANCEMENTS**

By Gary B. Little

In our April issue, we reported that Apple had announced four new chips to replace the 5602 microprocessor and the ROMs of the IIe. This month we have a follow-up, in-depth look at the new resources that these chips offer you.

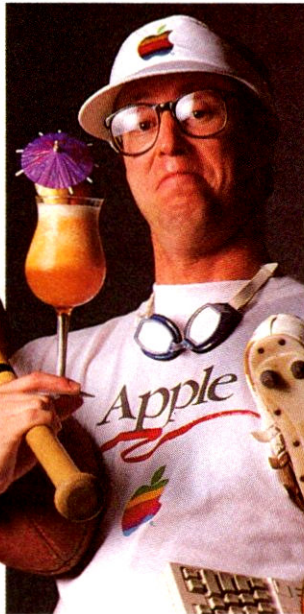

SOFTWARE

**57
THE PERFECT 2.0 SERIES**

By Chris Albertson

A hard look at the Perfect Series from Thorn EMI, including Perfect Filer, Perfect Calc, and Perfect Writer, with Perfect Speller, Perfect Thesaurus, and Perfect Link.

HISTORY

**66
IN SEARCH OF EARLY
APPLES**

By Vanessa Schnatmeier

You may not be Indiana Jones, but you can still be a Raider of Lost Apples. Read Vanessa's article on how we tried to locate the first Apples and find out the details of the treasure hunt and prizes we want you to be a part of.

TUTORIALS

**73
SPEAKING POSTSCRIPT
TO THE LASERWRITER**

By Steve Rosenthal

In Part III of our ongoing tutorial on the PostScript language, Steve details how this page-description language handles text presentation, and he takes you through some exercises in shaping your own alphabets and making your text fit in a defined space.

**79
UNDERSTANDING ProDOS**

By Gary B. Little

In his previous articles, Gary has introduced you to ProDOS directories, prefixes, pathnames, and all the Applesoft disk commands defined in a system program called BASIC.SYSTEM. This month he'll take a look at a utility program on the ProDOS User's Disk that you can use to perform file- and disk-handling chores.

DEPARTMENTS

9 EDITORIAL **11** LETTERS

17 THOUGHTWARE

By Steve Rosenthal
Summertime is the season to get out of the house, go for a trip, head for the park, or go for a swim. But before you put away your Apple until the first frost, take a look with Steve at some of the ways that a computer can play a supporting role in your hot-weather fun.

23 APPLEWORDS

By Steve Rosenthal
A short glossary of terms for use with our cover story, "Dot-Matrix Printers."



PAGE 89

89 TELECOMMUNICATIONS

By Russ Lockwood
When you want news about the U.S. government, where do you turn? What source do you use to gather up-to-the-minute information about national issues? The answer: Fednews from ITT. For details, read Russ' column on Federal news, bawdy bedfellows, and BBSs.

97 THAT'S ENTERTAINMENT

Reviews of Suspect, Typing Intrigue, MacVegas, Kampfgruppe, and Plato's Cave

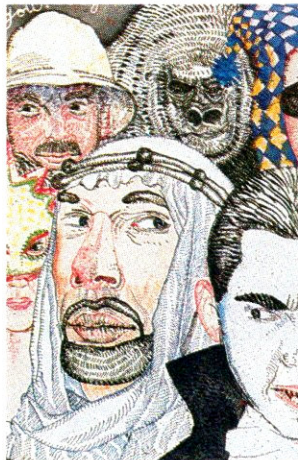

PAGE 97

148 PIPELINE

By Ruth Ramberg
Products you want to know about—for the entire Apple-computer line

167 RESCUE SQUAD

By Michael Callery
Disk backups, disk drive vs. RAMdisk, keyboard upgrades, and printer-control codes

173 COMING UP

174 INDEX TO ADVERTISERS

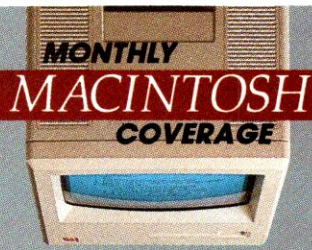

108



PAGE 136

123

136



143

Flight Simulator II

For Apple II,
Apple II+, & Apple IIe

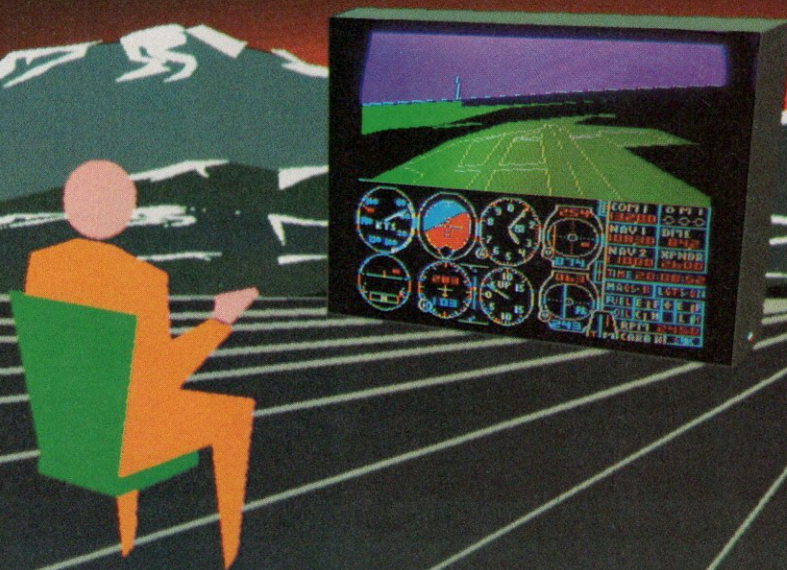

Put yourself in the pilot's seat of a Piper 181 Cherokee Archer for an awe-inspiring flight over realistic scenery from New York to Los Angeles. High speed color-filled 3D graphics will give you a beautiful panoramic view as you practice takeoffs, landings, and aerobatics. Complete documentation will get you airborne quickly even if you've never flown before. When you think you're ready, you can play the World War I Ace aerial battle game. Flight Simulator II features include ■ animated color 3D graphics ■ day, dusk, and night flying modes ■ over 80 airports in four scenery areas: New York, Chicago, Los Angeles, Seattle, with additional scenery areas available ■ user-variable weather, from clear blue skies to grey cloudy conditions ■ complete flight instrumentation ■ VOR, ILS, ADF, and DME radio equipped ■ navigation facilities and course plotting ■ World War I Ace aerial battle game ■ complete information manual and flight handbook.

See your dealer . . .

or for direct orders enclose \$49.95 plus \$2.00 for shipping and specify UPS or first class mail delivery. American Express, Diner's Club, MasterCard, and Visa accepted.

Order Line: 800 / 637-4983

subLOGIC
Corporation
713 Edgebrook Drive
Champaign IL 61820
(217) 359-8482 Telex: 206995

BusinessCard

Intelligent Multifunction Interface

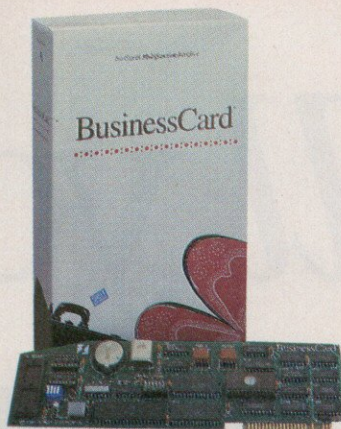

Street Electronics' new BusinessCard™ combines the five most popular Apple® IIe add-ons in one card – at less than half the cost of purchasing them separately. With the BusinessCard you can operate a printer and modem, time and date stamp your ProDOS™ files, buffer 20 pages of text, and print graphics and text to most popular printers.

Highlights include:

- ▶ Printer port (serial or parallel available)
- ▶ Modem port (300, 1200, or 2400 baud)
- ▶ Clock/calendar with battery back-up
- ▶ 16-64K print buffer (with optional Bufferkit)
- ▶ Compatible with Apple software like Appleworks, Mousepaint™ and Apple Access II.
- ▶ Graphic screen printing commands include windowing, zoom (magnification), double hi-res, rotate, inverse, & more.
- ▶ Text-formatting commands include margins, page and line length, titles, page numbers, type style, underlining, & more.

Call or write for our new products brochure or contact your local Apple dealer.

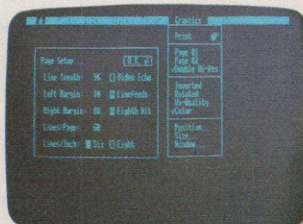

The BusinessCard uses "Macintosh™-like" pull-down menus to easily access over 60 built-in graphics and text commands – no software is needed.



Street Electronics Corporation
1140 Mark Avenue
Carpinteria, CA 93013
(805) 684-4593

CIRCLE 187 ON READER SERVICE CARD

Apple is a registered trademark of Apple Computer, Inc.
ProDOS and MousePaint are trademarks of Apple Computer, Inc.
Macintosh is a trademark of Apple Computer, Inc.



Publisher
Sydney H. Rogers

Editor
Maggie Canon

Senior Editor
Frederic E. Davis

Technical Editor
Chip Carman

Senior Copy Editor
Eva Langfeldt

Managing Editor
Leslie Steere

Copy Editor
Ruth Ramberg

Office Manager
Marjorie Gae Brandon

Consulting Editors
Michael Callery, Steve Rosenthal,
Roberta Schwartz

Contributing Editors
Chris Albertson, Sue Crissman,
W. Charles Doherty,
Russ Lockwood,
Vanessa Schnatmeier,
Mary Bohannon

Art Director
Peter A. Tucker

Associate Art Director
Fabian Cooperman

Art Assistant
Ae Kyung Kuark

Mechanical Artist
Kyle Houbolt

Editorial Office: 11 Davis Drive, Belmont, CA 94002; (415) 598-2290
Advertising/Business Office: Ziff-Davis Publishing Company,
One Park Avenue, New York, NY 10016, (212) 503-5105
Subscription Inquiries and Service: A+, P.O. Box 2965, Boulder, CO 80322,
(303) 447-9330

Advertising Manager
Mid-Atlantic/Southeast Manager
Mid-West Manager
Northwest Manager
Southwest Manager
Advertising Coordinator
Telemarketing Manager
Account Representatives

Suzanne M. Zellner
Thomas E. Richardson
Thomas J. Lutzke
David J. Ezequelle
Cynthia L. Ramsey
Angelo M. Turco
Cindy M. Silverman

EAST COAST Chris M. Tice
MID-WEST Andrew S. Dietz
WEST COAST Leslie C. Phillip

Timothy N. Carter
Helen Kempisty
Robert Woltersdorf
Shane Boel

Assistant to Publisher
Single-Copy Sales Director
Circulation Manager

COMPUTER PUBLICATIONS DIVISION

President
Vice President, Editorial
Vice President, Production
Vice President, Licensing & Special Projects
Vice President, Creative Services
Vice President, Circulation
Vice President, Circulation Services
Vice President, Marketing Services
Vice President
Marketing Manager
Business Manager
Editorial Director

Kenneth H. Koppel
Jonathan D. Lazarus
Baird Davis
Jerry Schneider
Herbert Stern
Alicia Marie Ivans
James Ramaley
Ann Pollak Adelman
Hugh Tietjen
Ronnie Sonnenberg
Gary A. Gustafson
Ernest F. Baxter

ZIFF DAVIS PUBLISHING COMPANY

President
Senior Vice President
Senior Vice President
Vice President
Treasurer
Secretary

Richard P. Friese
Philip T. Heffernan
Phillip Sine
William Phillips
Selwyn Taubman
Bertram Abrams

A+: The Independent Guide for Apple Computing ISSN (#0740-1590) is published monthly for \$24.97 one year, \$43.97 two years, and \$57.97 three years. Additional postage \$12 for Canada, \$12 other foreign by Ziff-Davis Publishing Co., One Park Ave., New York, NY 10016. Second-Class Postage paid at New York, NY 10016 and at additional mailing offices. POSTMASTER: Send address changes to A+, P.O. Box 2965, Boulder, CO 80321.

A+ is an independent journal, not affiliated in any way with Apple Computer, Inc. Apple is a registered trademark of Apple Computer, Inc. Entire contents Copyright © 1985 Ziff-Davis Publishing Co. All rights reserved; reproduction in whole or in part without permission is prohibited. The following are trademarks of Ziff-Davis Publishing Co.: A+, A+: The Independent Guide for Apple Computing, MacTips, Rescue Squad, That's Entertainment.

Permissions: Material in this publication may not be reproduced in any form without permission. Requests for permission should be directed to Jean Lamensdorf, Manager, Reprints/Rights and Permissions, Ziff-Davis Publishing Company, 1 Park Ave., New York, NY 10016. BPA membership (Selected Market Audit Division) applied for October 1983.



Epson *all* your conc

You have your computer. Now you want a printer. And you have natural concerns. Can you get a serious printer without having to spend serious money? What about compatibility? How reliable are they? Read on.

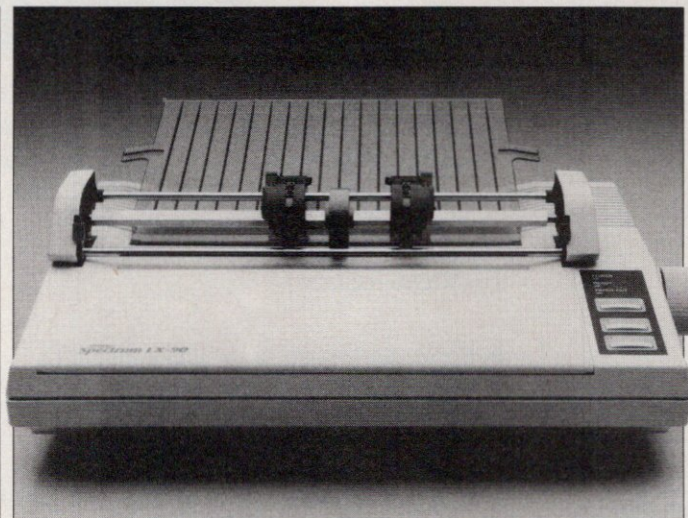

YEARS AHEAD OF THE **COMPETITION**

While most other printers only offer standard 90-day warranties, we stand behind Epson printers for a full year.

Of course, the warranty is one benefit of owning an Epson that very few people ever have the opportunity to take advantage of.

Another benefit you probably won't use is the industry's strongest local service network. But it's nice to know it's there.

Is it an Epson
????? **OR** ?????
Isn't it an Epson?

For over a decade, major computer companies have staked their own reputations on the reliability and performance of Epson printers by coming to us for the printers they sell with *their* computer systems.

The most
TRUSTED
printers
in the
WORLD

For years, Epson® printers have been the worldwide standard for low to moderate priced business printers.

And today, more homes and businesses rely on Epson printers than any other printers in the world. The reason is this. People know they can count on an Epson printer for the long run. Designed for performance and built for years of worry-free service, most Epson printers have been working longer than most printer companies have been in business.

You know you need a printer to get the best from your Apple®. And, if you're going to spend your own money on the equipment, you shouldn't have to settle for something unproven or less than reliable.

Check around. Now you can afford an Epson. Why settle for anything else?



INCOMPATIBILITY: *the irreconcilable difference.*

Software drives your computer. Software also drives your printer. And it's very possible that your computer software will not be compatible with your printer.

This can be shocking when the p's on your monitor come out

as q's on your printer.

But Epson printers are the standard to which virtually all major computer software is written. So just select the Epson printer and interface recommended for your Apple IIc or IIe and print your heart out.

answers comes in print.

HARD COPY DECISIONS MADE EASY.

Your Apple II[®] PC and our Spectrum[™] LX-90. It's the perfect match. With the low cost Spectrum LX-90 dot matrix printer and Epson's Printer Interface Cartridge (PIC[™]), you can print out draft mode at a speedy 100 characters per second. And produce Near

Letter Quality print at 16 characters per second. With



*"So the question is:
Which Epson?"*

both friction and tractor feeds, it prints on plain sheets or continuous form computer paper. The SelectType push button control feature lets you switch typefaces quickly and easily. And as with all Epson printers, your investment is protected by Epson's full-year warranty.

Your Apple II[®] and our Spectrum[™] LX-80. Our Spectrum LX-80 offers

print compatibility with your Apple IIe through a parallel interface. Like the Spectrum LX-90, it prints out at 100 characters per second, draft mode, and 16 cps Near Letter Quality. It features a standard friction feed, SelectType push-button typestyle control and very good graphic capability. Plus our full year warranty.

Epson dot matrix printers have very graphic advantages. Besides the versatility of draft and Near Letter Quality and the corresponding speed options, they can draw some very convincing pictures, including true circles.

**NOW THAT
YOU CAN
AFFORD
AN EPSON,
WHAT ARE YOU
WAITING
FOR?**

**ONLY
EPSON
PRINTERS
COULD GENERATE
PRINT LIKE THIS**

"Thank you for making such a rugged yet so fantastic piece of hardware."
L.F.G., Martinez, CA

"... a relief in this industry often faulted by products designed to last about ninety days."
John Cameron,
Medical Director,
Raleigh Hills Hospital

"I have had my Epson about six weeks... my only regret is that I didn't replace my old printer a year ago."
L.A.R., 29 Palms, CA

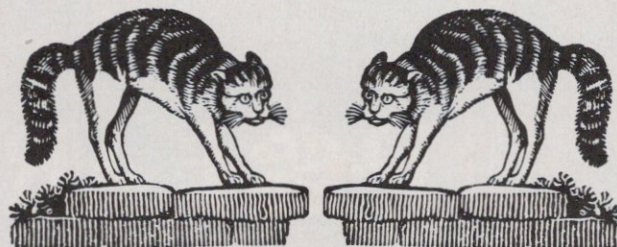

Recently in Martinez, California, two cats knocked an Epson printer 4 feet onto a tile/concrete floor. Although it didn't land on its feet, the printer is still running.



Spectrum LX-80

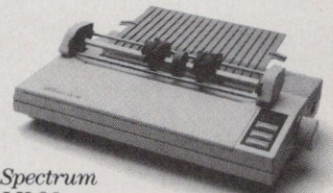

Spectrum LX-90

For more details, call
(800) 421-5426 or in
California (213) 539-9140.

EPSON

Number One.
And built like it.

Epson is a registered trademark of Epson Corporation. Apple, Apple IIc and Apple IIe are registered trademarks of Apple Computer, Inc. PIC and Spectrum are trademarks of Epson America, Inc.

RETURN TO TRANSYLVANIA

The Crimson Crown™

Almost three years have passed since the original Transylvania, the classic, award-winning graphics adventure, crafted and illustrated by Antonio Antiochia. Now, return to Transylvania in The Crimson Crown. The vampire has survived. The kingdom is in peril. Only you, with the aid of Princess Sabrina and Crown Prince Erik, can vanquish the demon and return the crown to its rightful owner.

It's the first of the new POLARWARE graphics adventures using Comprehend . . . an intelligent full- and multiple-sentence recognition and logic system. Graphics . . . the best you'll find. And now, the vocabulary, understanding, and depth they say can't be put into a graphics adventure.

It is not necessary to play Transylvania before playing The Crimson Crown. Available on Apple and Macintosh computers. Requires 64K.

For information about Crimson Crown and other Penguin software, please write for a free catalog to: Dept. A, P.O. Box 311, Geneva, IL 60134.

NEW

*Put a small universe inside your computer . . .
then climb right in!*

P·POLARWARE™

 penguin
software™
the graphics people

830 Fourth Avenue, P.O. Box 311, Geneva, IL 60134 (312) 232-1984.

Apple is a trademark of Apple Computer, Inc.; Macintosh is a trademark licensed to Apple Computer, Inc.; The Crimson Crown, Transylvania, Comprehend, Polarware, and Penguin Software are trademarks of Penguin Software, Inc.; Penguins rarely avoid water hazards when playing golf.

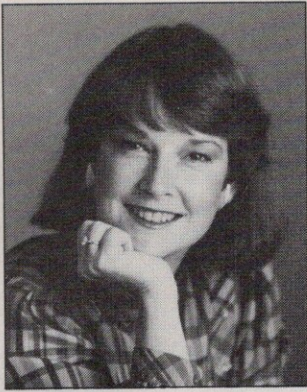

Discover 'leisureware' for your summer computing, and join a treasure hunt for the first 100 Apples.

THE PURSUIT OF FUN AND EARLY APPLES

We all know some people who have absolutely no sense of fun. Still, we felt confident in our readers' perspicacity when we decided to make summer fun the theme of this month's issue. Computer users have been known to take computing a bit too seriously, but I've noticed that Apple users consistently find interesting and fun ways to use their computers. After all, many of the first programs developed for the Apple II were games, and the Macintosh certainly makes computing easier and more fun, even for those more-serious tasks.

Our search for amusing ways to use your computer yielded quite a few interesting items. John Barry, in his article "Leisureware" came up with a new software category. "Leisureware" can be just about any software that's not business-oriented, covering topics that range from baseball statistics, to gardening, to bartending.

Our steadfast Steve Rosenthal, in his "Thoughtware" column, has some suggestions on how to vacation and travel with your indispensable Apple computer.

To add to the fun, we thought it would be interesting to find as many of the original Apple computers as we could. As you will see when you read Vanessa Schnatmeier's article "In Search of Early Apples," finding the first ten Apples was a much tougher assignment than we had anticipated. Who better to turn to for help in finding these elusive grandparents than all of you Apple owners out there? We're

now looking for any Apple I or II with a serial number under 100 (we've broadened the field a bit), and we will give you a certificate and a token of appreciation for finding one of the original 100 Apples.

I have decided to take this treasure hunt even one step further. Find an example of a unique application (nothing risqué, please) and send it to me. I will then pick what I believe to be five of the most unusual submissions to include in a column.

For *A+*, this summer also brings changes. Two members of the editorial staff are moving on and up in the world. Our intrepid senior editor in charge of features, Jane Willson, has accepted a position as associate managing editor of Ziff-Davis' exciting new product, *The Computer Industry Daily*. *The Daily* is headed by the well-known and respected industry analyst, Esther Dysan. Candy De Santis, our exuberant assistant editor, is going to Apple Computer, Inc., where she will work with Apple University. Both Candy and Jane have been with us since we started, and we are indebted to them for their invaluable contribution in helping *A+* become the number one Apple magazine. We wish them much luck in their new endeavors.

Departures usually mean that new people arrive, so I am pleased to introduce the newest member to the *A+* team. Chip Carman has been working for us for nearly a year as a technical consultant. We are delighted to welcome Chip as a full-fledged member of the staff. +

Maggie Canon

UltraTerm Gives You a Choice!

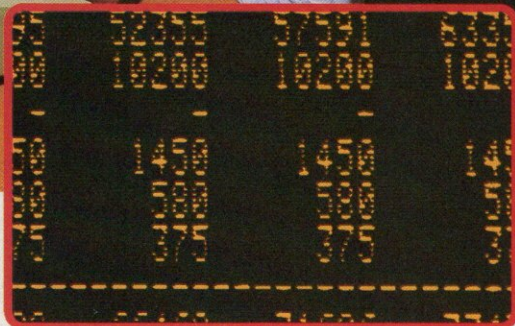

Apple //e 80 × 24 display

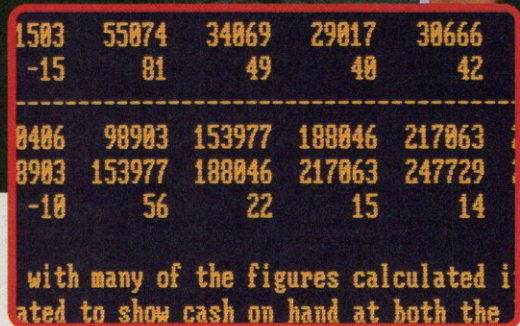

UltraTerm 128 × 32 display

Which display would you choose? The UltraTerm's display is clearer, crisper and easier on your eyes than the standard Apple //e's 80-column display. Something you'll appreciate the next time you have to spend long hours working with your computer.

UltraTerm gives you freedom of choice! Eight different modes allow you to tailor the display to your needs. From 128 columns by 32 rows (Ideal for spreadsheets!) to 80 columns by 48 rows, or even 160 columns by 24 rows, UltraTerm gives you the best display possible.

There is also a wide choice of popular programs that can take immediate advantage of the UltraTerm's expanded display.

Programs like MultiPlan, Word Juggler //e, WordStar, FlashCalc and SuperCalc to name a few*. Videx also has pre-boots available for AppleWorks, AppleWriter //, and VisiCalc.

And now, UltraTerm works with most monitors to give you the best display possible for your eyes, and your piece of mind. Contact your dealer today for a demonstration.

*Complete list of compatible software available from Videx, upon request.

Videx is a registered trademark of Videx, Inc.

AppleWorks and AppleWriter// are trademarks of Apple Computer, Inc.

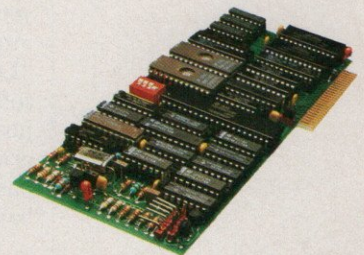

UltraTerm for standard video monitors
New low price—\$299.00

High-Quality Character Kit
\$49.00



1105 N.E. Circle Blvd.
Corvallis, OR 97330
503-758-0521

▶ IIE ENHANCEMENT

Dear A+,

I just finished reading the April issue of A+, and I found the article "Is There a IIC in Your IIE?" most interesting. I thought that the article could have been a little more specific or detailed. I bought my second Apple IIE March 8, and it did not have the enhancement feature. After reading your magazine, I was not sure whether or not my new Apple should have had the new feature. The article stated that "as of March, every new Apple IIE has these four chips in place of the old ones. Owners of earlier incarnations of the IIE can get them installed at a dealership for about \$70. (All installations are made by dealers. You *cannot* take the chips home and install them yourself.)" I was not sure when the cutoff date was in March on the enhancement feature. An Apple technician told me that the cutoff date was the first of March. I immediately contacted the other Apple dealer from whom I'd purchased the IIE and told him about my new Apple not having the enhancement feature. When he told me to bring in my entire system and he would exchange it for one with the new feature at no charge, I was delighted.

Thanks to the article, I was made aware of the feature. Had it not been for your magazine, I probably would not have the new feature now. I figure that your magazine saved me \$70 in the upgrade cost, which more than offsets the amount of the subscription.

Another minor fault in the article was regarding the chips. According to one Apple dealer, I could have gotten the upgrade chips from him and put them in myself. Even though the dealer said that there was really nothing to it, I declined.

I wish that the article had been more detailed. I was always under the impression that the journalists who wrote these articles had the equipment or knew of someone who tested it, and

were there when it was tested. I surely hope that these journalists are not just deriving pleasure from the manufacturer's specifications when writing these articles.

Robert P. Johnson
Twin Lakes, WI

We're glad that you found our April story about the IIE enhancement helpful. The reason that the article was not more specific is that Apple did not provide us with the official details about the IIE enhancement; we wrote the article when Apple was keeping this information secret, and our author had to do some behind-the-scenes work to piece together the article. Now that Apple has formally announced the product, we have more information about the IIE enhancement. "A Close Look at Recent IIE Enhancements," starting on page 45 of this issue, will fill you in on more details about this new development for the IIE.—Editors

▶ DISAPPOINTED IN IIC LCD

Dear A+,

I am a proud owner of an Apple IIC that I use for work as well as pleasure, but I have a complaint that echoes Frederic E. Davis' comments in your May 1985 issue on the new IIC LCD flat-panel display.

I bought the machine last year because of the wonderful reputation that Apple has earned and since I needed a portable computer that could eventually be used during business trips (with the anticipation of adding the flat-panel display upon its release). For those of us who travel frequently by air or train—often internationally—a small portable computer is a great investment that eliminates a lot of otherwise useless travel time.

After examining the new LCD unit on display, I feel that I am only one of thousands of Apple IIC users who are not only disappointed but also disgusted at Apple's attempt to sell us an inferior add-on at such a ridiculous price. Does

Apple actually believe that the same people who made an intelligent decision to buy an Apple IIC will buy this new LCD display? Come on Apple, go back to the drawing board and design the type of product your valued customers have come to expect from you... a good one!

Jerry C. Drew
Dallas, TX

▶ MORE ON MUSIC

Dear A+,

Your recent articles on music (November 1984) and speech (May 1985) are very efficient summaries of the hardware and software available and are surely a help to all who read them.

Your readers might be interested to know that there is hardware compatibility between the board provided with Software Automatic Mouth (Tronix) and the Micro Music DAC board, which supports the Micro Music Software library. Buying either hardware unit (S.A.M. is the less expensive of the two) will allow you to run S.A.M. speech programs and Micro Music disks. As author Steve Rosenthal pointed out, the S.A.M. board terminates in bare-wire ends. I simply cut an RCA patch cord (phone jacks on both ends) in half and spliced it onto the wires coming from the board. On my board, the gold wire is the ground, and it was patched to the outer portion of the RCA plus (the silver is connected to the volume-adjustment port, so that must be the "hot" side).

Though the S.A.M. board is not extremely powerful, it drives a small speaker adequately, and it does a satisfactory job through headphones. It is certainly a low-cost alternative method to access the music software.

Marc Apfelstadt
Greensboro, NC

P.S. Readers may want to confirm my suppositions as to the identity of the ground wire—wouldn't want anyone "hot-wired" because of me!

GOT A COMPUTER? GOT A PHONE?



GET A DEGREE.

Now, for the first time, you can take real courses, from live instructors, right in your home or office, right on your own personal computer. You can use an Electronic Library for research, tune-in to interactive seminars, and take advantage of a full counseling center.

The Electronic University is a national educational system that connects your personal computer to recognized colleges and universities located throughout the country. You can study nearly any subject at your own pace, and on your own schedule.

Finally, technology is eliminating those barriers (time, location, and high cost) that have prevented you from completing your college education, entering a Master's Degree Program, or just taking that course you've always wanted to take.

No computer knowledge is required to use the system and all communication costs

are included in the course prices.

Degrees available through the Electronic University include: Associate Degrees in Business and General Studies, Baccalaureate Degrees in Business and the Arts, several MBA Degrees, and specialized Certificate Programs. There is also a variety of non-credit courses offered over the system, as well as Tutoring Programs for children.

Isn't it time to involve yourself in education once again? Have some fun, become part of the spirit of a national university system, and better yet, open up a world of new opportunities for yourself and your entire family. *Call us today:*

800-22LEARN or
800-44LEARN
in California.

THE ELECTRONIC UNIVERSITY
505 Beach Street, San Francisco, CA 94133
415/928-2800

► IIC COMMUNICATIONS

Dear A+,

I just finished reading Mark Andrews' article "The IIC Communications Gap," in the May issue of *A+* (pages 73-75) and felt compelled to share my experiences with you.

I was an excited Apple IIC customer in May 1984 and bought one of the first IIC's in my area. After learning to use the machine, I decided to add a modem and begin telecommunicating. I had nothing but raves for Apple until I bought the Apple Modem 300 and added it to my shiny new IIC!

The IIC and Apple Modem 300 combination was able to deliver only occasional lines of error-free text! It was suggested that causes for this poor operation were bad phone lines (my line is on a new electronic switching system, so that made no sense) and even atmospheric conditions affecting microwave long-distance lines. Neither suggestion was good or rational, because errors continued even on very clean local loops. My first experiences were frightful and discouraging. I was very upset about having spent a couple of hundred dollars to get such poor performance.

Then one day, quite by accident, I was having a discussion with one of the Apple dealer reps and he suggested the motherboard exchange. He said that Apple would "pay" the dealer for this work if I was using a non-Apple modem and that since I had an Apple Modem 300, he would "work something out." So, I got a new motherboard installed by the dealer, at Apple's expense, and took it home—my problems were gone! The local dealer was great for performing the work for me, and I have had no problems since the swap.

Your article really hit a sensitive spot for me, because of all the Apple-specific problems I have had and what Apple is apparently saying about them. As a service manager for an electronic-equipment manufacturer, I know what it's like when there is a technical problem as a result of a design oversight. I also know how it affects a customer's perception of the product and the company. I have determined that the only thing a reasonable company can do when things like this happen is to admit the error and correct the problems. Customers will naturally become upset because of factory problems, but they respect a dedicated effort to correct the problems. Trying to say you don't have a problem when you really do doesn't cut it with an irate customer, and it didn't take me months of testing to

know that I had a very real problem, with a bit of political football (I now find out) for an answer. Come on now, Apple, who are you trying to fool?

Thanks for the enlightening article and for not being afraid to call it straight. The IIC and Apple Modem combination make a terrific communications system. Now that my machine has been updated with a new motherboard, I am having a great time exploring the world of telecommunications. Other IIC owners should not let these problems stand in the way of buying a modem, Apple or otherwise, for the IIC.

Dave Montgomery
Bloomington, IL

▶ ANOTHER VOICE— SYMPHONIX

Dear A+,

Missing from the article "Season'd with a Gracious Voice," in the May issue, is the SynPhonix voice.

I have been using SynPhonix for several months; it is the only speech articulator for Apples that has not caused the reaction "What did it say?" Previously I used the Echo+ and have researched the Intex-Talker, Mockingboard, and Votrax models.

One of my needs was the capability to talk and do graphics at the same time, which SynPhonix accomplishes through the use of interrupts, except for disk operations. It can also make music and sing, but not dance.

It speaks with a slight nasal quality, but by far is the most understandable speech synthesizer I have heard for the Apple.

SynPhonix is made by Artic Technologies, 2234 Star Court, Auburn Heights, MI 48057; (313) 852-8344.

Max Ward
Santa Barbara, CA

▶ CORRECTIONS

Mockingboard

Sweet Micro System's Mockingboard sells for \$179, not \$219 as stated in Steve Rosenthal's article "Season'd with a Gracious Voice," in our May issue.

MouseTrace

In the "Pipeline" section of our June 1985 issue, we incorrectly listed Village Computer Resources of Lakewood, CA, as the developer of the product MouseTracer. Village Computer Resources' product is MouseTrace, and it sells for \$99. (See this month's "Pipeline" for corrected information about both products.)

BETTER THAN RAMWORKS™

MultiRam™ (formerly MaxiRam) offers everything Ramworks does and adds much more with unlimited future use & less power drain. **AVAILABLE NOW** for both the **Ile** and **IIC** at lower cost from Coit Valley Computers:

	Ramworks	MultiRam Ile
100% Extended 80 Compatible	Yes	Yes
Warranty	3 yr	5 yr
Main Board Maximum	512k	768k
Piggyback Board Maximum	512k	768k + FREE RGB
Total Memory Possible	1024k	1536k (50% MORE!)
AppleWorks™ Expander Software	Up to 735k	UP TO 1100k
Ramdrive Software	\$29	FREE
RGB option	\$129	FREE on Piggyback
65816/8086/6800 CPU Port	No!	Built in FREE

	Ramworks Comparable (Ramdrive Extra)	Coit Valley Computer Price (Ramdrive FREE)
64k MultiRam Ile Card	179.	159.
128k MultiRam Ile Card	249.	215.
256k MultiRam Ile Card	299.	278.
512k MultiRam Ile Card	399.	376.
768k MultiRam Ile Card	653.	480. (WOW!)
1024k MultiRam Ile Card	649. (No RGB)	709. (FREE RGB)
1280k MultiRam Ile Card	No!	797. (FREE RGB)
1536k MultiRam Ile Card	No!	885. (FREE RGB)
256k MultiRam IIC Card	449. (Z-80)	325. (No Z-80)
512k MultiRam IIC Card	649. (Z-80)	459. (No Z-80)

MORE MEMORY

Our **FAST** (150 NS) RAM chips, **GUARANTEED** 1 year, can expand MultiRam cards up to 1536k or Ramworks & Legend™ cards up to 1024k! We can expand Multicore™, Z-ram & others also. Easy installation instructions included. CALL FOR LATEST PRICING.

	List	Our Price
64k Memory Expander Chips	70.	35.
128k Memory Expander Chips	140.	62.
256k Memory Expander Chips	150.	124.
512k Memory Expander Chips	300.	227.
1024k Memory Expander Chips	600.	424.
AppleWorks™ Program	250.	210.
Ile Enhancement Kit	70.	62.
Pico™ Slim Drive Ile, IIC	270.	178.
Bernoulli™ Box Macintosh™	1995.	1765.
MultiView™ 80/160 Card	350.	289.
Imagewriter™ (15")	749.	626.
PC Megastore™ 20 Meg Hard Disk & 25 Meg Tape Backup II+, Ile	3595.	2889. (WOW!)

Terms: For fastest delivery send Cashier's/Certified check, Money Order. C.O.D. (add \$2) & personal checks accepted (allow 14 days). Add \$3 shipping & phone # to all orders. Add 3% for MasterCard/Visa (include #/expir). Tex res add 6½% tax. **CALL FOR LATEST PRICES!**

MultiRam/Multiview, Ramworks/Z-ram, Appleworks/Macintosh, Legend, Pico, Bernoulli, PC Megastore, Multicore respective trademarks of Checkmate Tech, Applied Engineering, Apple Comp, Legend Ind, WGE Int, Iomega, Ampex, Quadram.

COIT VALLEY COMPUTERS
14055 Waterfall Way

(214) 234-5047
Dallas, Texas 75240

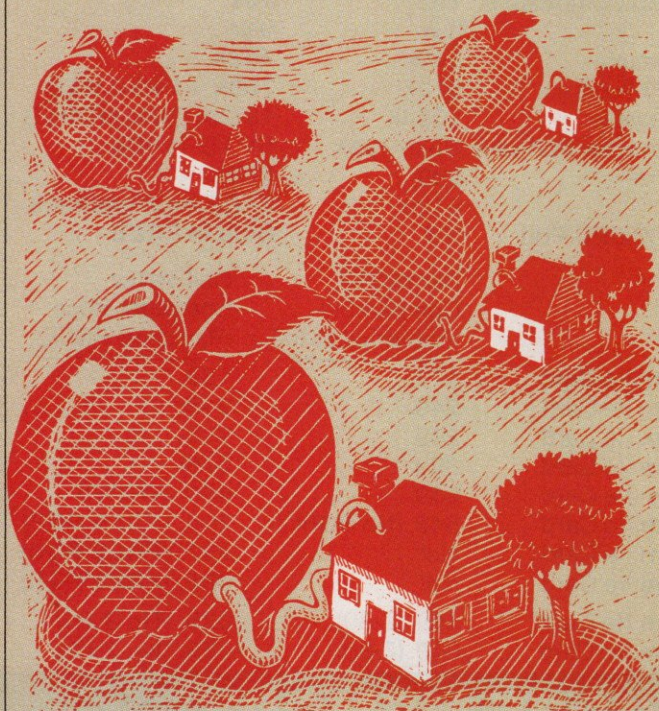

▶ HOW SMART IS YOUR HOME?

Is your house smart enough to water the lawn or turn off your hot-water heater when you don't need it? Is it smart enough to call the fire department or police department in case of a fire, burglary, or other emergency? Now, with the help of an Apple-II-series or Macintosh computer and a product called Smarthome, you can have the most intelligent house on the block.

The Smarthome home-control and security system from CyberLynx has proven so popular that several housing developments around the country have adopted it as a feature of their homes. Lancashire Homes, a 200-unit development in the Antelope valley, north of Los Angeles, was the first to offer Smarthome and an Apple as part of the purchase price of a new home.

Smarthome is also available as a peripheral product for your Apple, and, since it runs in the Background mode, you can still use your computer for all of your other work. For more information, contact CyberLynx, 4828 Sterling Drive, Boulder, CO 80301; phone (800)-SECURE9 or, in Colorado, (303) 444-7733.

▶ COPY PROTECTION

Before microcomputers arrived on the computing scene, software copy-protection was unheard of. The prevailing custom was to make a copy of your software as soon as you received it, put the original in storage, and use only the copy. With the advent of microcomputers and low-cost software, however, many companies have devised ways of inhibiting the copying of software.

I personally don't like copy-protection, because it makes it difficult or impossible to create backup disks or to use protected programs on a hard disk, RAMdisk, or other non-standard storage device. Whenever I have a choice between two programs, one of which is protected and the other is not, I choose the unprotected one. In fact, in a business setting, you must be able to back up your program diskettes. Imagine not being able to collect your bills or file your tax reports because someone has spilled coffee on the only copy of your program.

Because of protests from users, some companies are no longer copy-protecting their software. Stoneware has removed the copy-protection from DBMaster, MicroPro has removed it from WordStar, and Forethought is removing it from FactFinder and FileMaker. If we want this trend away from copy-protection to continue (and I know I do), we have an increased responsibility not to violate the trust these companies are putting in us: Do not copy disks for purposes other than creating backups for yourself.



▶ SITE LICENSES

One of the hottest topics of discussion in the microcomputer industry nowadays is the issue of site licenses. A site license is a license to copy a software package for all the computers at a particular site. This issue is of particular concern to government agencies, corporations and educational institutions that have many microcomputers at a single location. Site licenses are common in the world of mainframes and minicom-

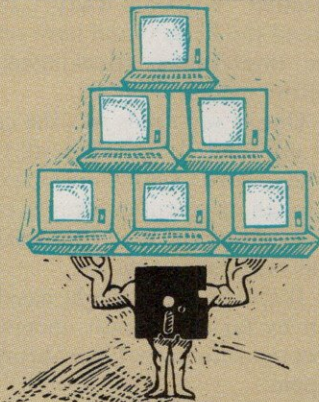

puters, but only recently has the personal-computer industry begun to take a hard look at the issue of site licenses for microcomputer software.

The subject of site licensing is bitterly disputed. Those who are against site licensing fear loss of revenues and promiscuous copying of their software. The advocates of site licenses, on the other hand, say they need licenses to make using microcomputers cost-effective at all.

For example, a large corporation with 1000 micros would have to pay a quarter of a million dollars to outfit each computer with \$500 worth of software, even as-

suming the programs were bought at a substantial 50% discount. This high cost makes it cheaper to use minicomputers or mainframes. A site license would allow an organization to pay a flat fee to buy one copy of each program for internal distribution and use. Two companies that have taken the lead in the Apple market are Sorcim/IUS, which offers a site-licensing arrangement for its new SuperCalc3A program, and DeskTop Software, which offers a site license for its Macintosh database 1stBASE.

I think site licenses are critical to the future growth of the personal-computer industry; if software companies make it too expensive to use micros, they will be cutting their own throat in the long run by making it cheaper to use large, multiuser computers.

▶ MAC TAPS INTO LEXIS/NEXIS

Information is the lifeblood of American business, and better access to information can help businesspeople make more informed business decisions. Recently Mead Data Central announced Lexis/Nexis Communications Software for

the Macintosh that makes it easier to access the Nexis news retrieval service and the Lexis legal-research service and to save and recall search results.

The Nexis database contains the full text of more than 135 newspapers, magazines, wire services, and newsletters, in addition to SEC filings and research reports from top brokerage and investment-banking firms. Lexis is an on-line information service that covers case law, statutes, codes and regulations, and other information of interest to attorneys. For more information, contact Mead Data Central, P.O. Box 933, Dayton, OH 45401; (800) 227-4908.

▶ MAC MUSIC MANIA

MusicWorks, the innovative music-composition program from MacroMind, has started a revolution in music technology and in Macintosh software. Previously, you pretty much had to have a piano in order to compose music. Now, with the advent of programs such as MusicWorks, you can use the Macintosh as an effective composition tool.

MusicWorks, although it's a great program, has a



few shortcomings. But have no fear, new software is near. MacroMind is planning a new, improved version of MusicWorks; Great Wave Software has a nice program called ConcertWare Plus; and Electronic Arts is preparing a Deluxe Music Construction Set for the Macintosh computer that is far better than its counterpart on the Apple II series.

The next phase of development for music software on the Mac will be to produce programs that work with MIDI-compatible electronic instruments. MIDI, which stands for Musical Instrument Digital Interface, has been adopted as a standard for controlling electronic instruments by many manufacturers, including Roland, Yamaha, and Casio. Rumor has it

that several companies (including Assimilation, of Mac Turbo Touch fame) will be marketing low-cost MIDI controllers for the Macintosh in the near future. These developments could well make the Mac the computer of choice among musicians.

▶ SPREADSHEET WARS HEAT UP

Electronic spreadsheets such as VisiCalc helped get the microcomputer industry off the ground. VisiCalc was the first superstar spreadsheet, and Lotus 1-2-3 was the second. Both of these programs have inspired numerous clones. Even Steve Wozniak of Apple II fame wrote a knock-off of VisiCalc called WozCalc, which he donated to an Apple users' group.

Now the battle to create superior spreadsheets for the Apple is heating up again. This time around, the major players are Lotus with Jazz for the Mac, Microsoft with Excel for the Mac and Multiplan for the Mac and Apple II series, Paladin with Crunch for the Mac and FlashCalc for the Apple II series, VIP with VIP Professional for the Mac and II series, Apple with AppleWorks for the II series, Sorcim/IUS with SuperCalc3A for the II series, Version Soft with Mouse Calc for the II series, and Software Publishing with PFS:Plan for the II series. We're keeping our eyes on these programs and will be bringing you in-depth coverage of some of these packages.



THE KACHE BOARD GIVES YOU WHAT YOU'VE BEEN WAITING FOR TEN TIMES FASTER.

SPEED UP THE RESPONSE TIME OF YOUR MICROCOMPUTER BY AS MUCH AS 10:1.

Ohio Kache System's™ "Kache Board"™ effectively reduces the frequency of hard disk accessing, and consequently, the cause of most "waiting frustration"—mechanical latency. Apparent response time can be reduced by up to ten times since data requested already resides in cache memory. The Kache Board features a microprocessor that actually manages the operation of the cache memory buffers without drawing on your microcomputer's main processor. Data in cache memory is constantly purged to maintain 256K of the most frequently accessed data, combining the speed of RAM disk with the capacity of hard disk.

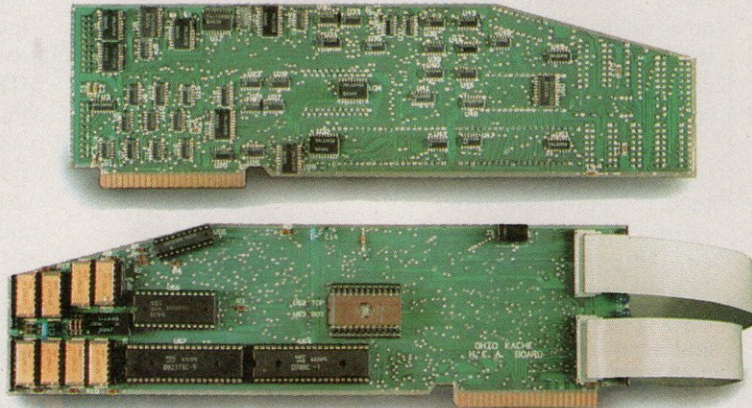

devices, are mounted on the underside of the board in a highly concentrated schema. This allows room on the top side of the board for the microprocessor, memory chips, custom integrated circuits and other components that, to date, are not available in SMD proportions.

EASE OF INSTALLATION.

The Kache Board is easy to install and can reside in any one of four slots: 4, 5, 6 or 7. In addition, a cable is provided for ease of installation to your 50 pin SCSI disk connection.

The self-contained power source plugs into the Kache Board and relays power from any standard 110 volt electrical outlet.

AVAILABLE FROM MANUFACTURER ON A DIRECT MAIL BASIS.

The Kache Board is available from Ohio Kache Systems (OKS) on a direct mail basis only. A rigorous 48 hours of testing is completed on every unit prior to shipment. Nonetheless, Ohio Kache Systems offers a 90 day warranty on all components and labor as well as a 30 day trial period. If the Kache Board doesn't perform as we say it will, return it to us for a full refund.

THE KACHE BOARD IS SUPERIOR TO RAM DISK.

The Kache Board offers performance that is superior to RAM disk for three primary reasons: data is automatically updated on the disk as it is changed, minimizing its vulnerability; data fetching from disk is transparent, eliminating the need to copy files; and cache memory retains only those files that are most frequently accessed, ensuring the greatest possible reduction in hard disk accessing.

SYSTEM COMPATIBILITY.

To date, the Kache Board is only compatible with Apple II+ and IIe systems with hard disk drive; however, boards for IBM, AT&T and Texas Instrument microcomputers are already in final testing stages and will become available later this year.

TECHNICALLY SPEAKING.

The Kache Board, a host adapter, is compatible with most Small Computer Standard Interface (SCSI) hard disk drives. Management of the cache memory buffers is carried out by a Z80 microprocessor which draws its power from an outside, custom tabletop power source (available as an optional purchase). Heat dissipation from the board amounts to approximately 6 watts.

SURFACE MOUNTED DEVICE TECHNOLOGY.

The functionality and intelligence of the 11" x 3¼" Kache Board is made possible by the technology of Surface Mounted Devices (SMD's). SMD's, tiny integrated circuits a fraction of the size and weight of conventional

ORDER TODAY

The OKS Kache Board comes complete, ready for installation in your Apple IIe or II+ for \$695.00. You can order yours by calling toll-free:

800-338-0050

Phone orders may use Visa or MasterCard. To order by mail, write to the address listed below. For faster service use Visa, MasterCard, bank or certified checks. Please allow 18 days for delivery of shipments accompanied by money orders, company or personal checks.

Kache Board (256K).....	\$695.00
Optional Power Source	\$35.00
6 Ft. Shielded, 50 Pin Extension Cable	\$40.00
6 Ft. Non-Shielded, 50 Pin Extension Cable	\$30.00



Prices include shipping and handling. Ohio residents please add 5.5% sales tax.

For further information on the Kache Board, Ohio Kache Systems Corp., or the compatibility of your hard disk drive, please contact us at (513) 746-9160.

Ohio Kache Systems, Corp.
75 Tahlequah Trail, Dept. 11,
Springboro, Ohio 45066-1154

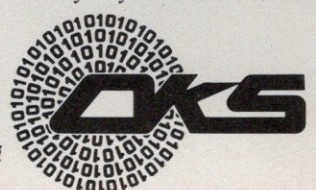

THOUGHTWARE BY STEVE ROSENTHAL

Your Apple can flavor
your summertime
activities.

OFF-SEASON APPLICATIONS

Let's face it: Many of summertime's most pleasurable activities don't depend on a computer. Summertime is the season to get out of the house, go for a trip, head for the park, or go for a swim. But before you put away your Apple until the first frost, take a look at some of the ways that a computer can play a supporting role in your hot-weather fun.

Just as during the rest of the year, you can use an Apple as a tool to help you get chores done faster, or you can use it as a source of entertainment. Even if you're taking the summer off from school, you might still want to use your computer for some special learning projects.

If traveling is part of your summer plans, you may or may not want to take your computer with you. Of the Apple family, the Mac seems to travel the best, the IIc a close second. Although the IIc is smaller, I've found the IIc power transformer, screen, and a monitor more trouble than the Mac's keyboard and mouse—and the IIc LCD screen is still not good enough for my taste. The number of items and cables to set up is usually a more important factor than the precise size of the box.

Are you thinking of setting your computer up on a picnic table or even in a hotel room? Don't forget to bring a long, grounded extension cord. If you're planning to work outdoors or near a pool, you definitely should use a ground-fault interrupter (GFI) shock-protection device as part of your power connection. These units cut off power in a fraction of a second if they sense that electric current is escaping through some other path, rather than returning to the outlet. You probably won't have a problem with an Apple, but if some-

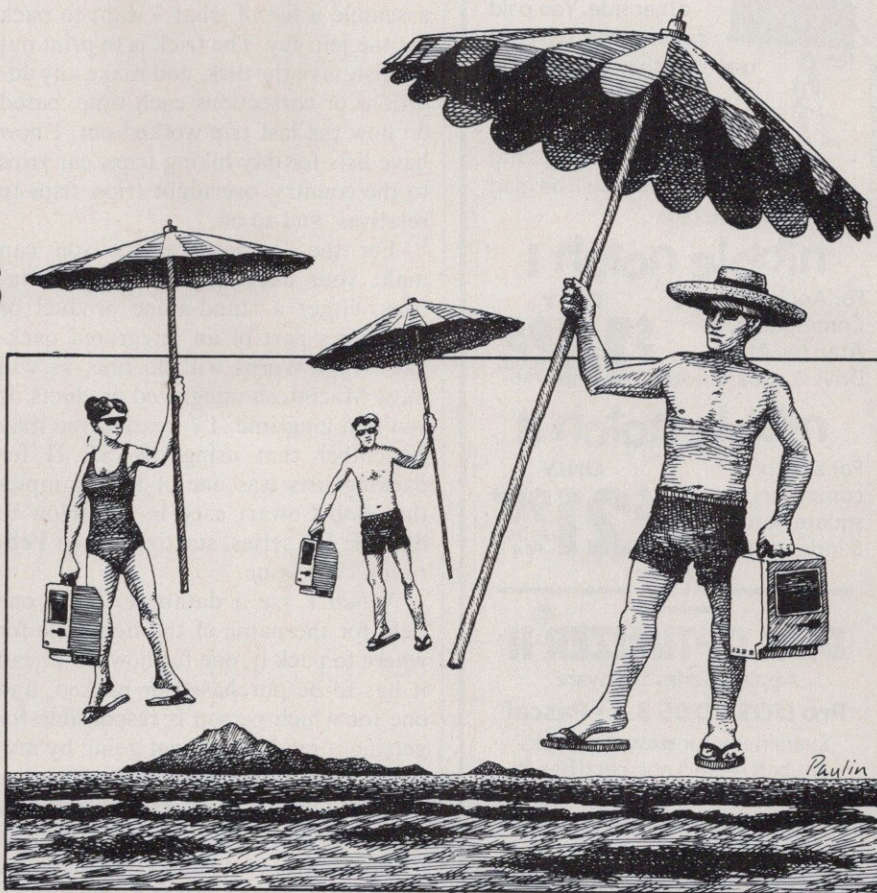

thing does go wrong and you're part of that path, you want the power shut off in much less than a heartbeat.

If you're going abroad, be sure to check into what you need to temporarily run your Apple on the type of power supplied at your destination (see "Tak-

► **Before you put away your Apple until the first frost, take a look at how it can play a supporting role in your hot-weather fun.**

ing Your IIc to Europe" in the January 1985 issue of *A+* for a complete discussion).

The Light Fantastic

Either at home or on the road, summertime means longer daylight hours. When the light is bright, even indoors

in a sunny room, you'll probably need some kind of antiglare screen to cut down the reflection from the external world that bounces off the CRT screen. A nylon-mesh antiglare screen will help, but a coated or polarized filter will do even more to limit reflection. Otherwise, you'll find yourself squinting at a dim undertone of the computer image on what looks like a slightly curved mirror. I've found draping three sides of a cardboard box around the screen helps both to keep the glare of direct sun off the screen and to keep my computer from frying. On a hot day, you'll certainly need to keep your Apple out of direct sun, a precaution also necessary for any floppy disks.

Before you go, be sure to make a practice journey, even if it's to another room of the house, to see what you really need to set up your system in a new location. Then make a checklist of what you need to take, with space both to check that it goes with you and also to

Paulin

IT'S LIKE **FREE** DISKETTES

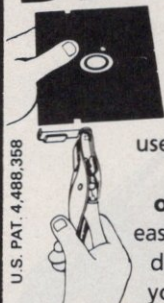

U.S. PAT. 4,488,358

Your 5¼" single side disks are usable on the other side. You paid for one side, why not use the other... **IT'S FREE!**

Nibble Notch will open your **new** disk. It's easy... won't harm existing data. Try it, you'll be glad you did!

nibble notch I

For Apple, Franklin, Commodore, & Atari (w/Atari Drives); square notch.

ONLY **\$14.95***
PLUS P&H

nibble notch II

For all other computers; square notch & index hole.

ONLY **\$21.90***
PLUS P&H

ALSO

DISK OPTIMIZER II

Apple II Series Software

Pro DOS • DOS 3.3 • Pascal

Examines your **new** disk, locks out bad sectors and **certifies** it **100% ERROR-FREE** in 30 seconds or less! Also checks drive speed...and more!

SUPER SAVER PACKAGE

Nibble Notch I and Disk Optimizer Combo (Optimizer alone reg. \$24.95)*

\$29.95* FOR **BOTH!** PLUS P&H

Call for **HIGH QUALITY DISKETTES**

as low as **99¢**

* Add \$2 (\$5 foreign) for postage & handling. FL residents add 5% sales tax.

SATISFACTION GUARANTEED OR YOUR MONEY BACK!



ORDER TODAY



TOLL FREE 1-800-642-2536
FL (305)748-3770, 9am-6pm ET

or send check or money order to:

nibble notch[®]
computer products
4211 NW 75th Terrace • Dept. 233
Lauderhill, FL 33319

check off that you've packed it all up again for the trip home.

Check That List

Making packing lists before taking even a one-day trip, in fact, is the best use of computers for traveling that I've found so far. Even when I'm not taking along a computer (which is most of the time), I use one of my machines to help assemble a list of what I want to pack for the journey. The trick is to print out the list, save the disk, and make any additions or corrections each time, based on how the last trip worked out. I now have lists for day hiking trips, car trips to the country, overnight trips, trips to relatives, and so on.

For the fanciest results, you can make your packing lists with a database, either a stand-alone product or one that's part of an integrated package. AppleWorks will do fine, as will most Macintosh integrated products. If you're a longtime *A+* reader, you may remember that using dBASE II for packing lists was one of the examples that Bob Cowart used in his "How to dBASE II" series, starting in the February 1984 issue.

When I use a database, I use one field for the name of the item, one for where to pack it, one for how far ahead it has to be purchased or packed, and one for which person is responsible for getting it ready if I'm not going by myself. I also set up a field for the quantity of items I want to take more than one of and a field for what kind of trips this listing applies to. I suppose I could also add the weight or cost if I thought I'd be close to the limit on either.

Once I've decided on a journey, I take my closest previous list; add and delete items based on what worked out the last time; add any special items; and then print out the list, sorted on each field—that method gives me several lists, but since the computer does most of the work, it's not much trouble to make the whole set. Each list seems to have its own value.

I use the time-sorted list to make sure I get tickets, check the fan belt, turn on the answering machine, tell the neighbors, and water the plants. It's particularly helpful for avoiding that feeling that I must have forgotten something obvious during the last few hours of preparation. Some items have meaning only as part of a last-minute activity checklist—after all, you don't pack watering the plants—but having everything on each list has been easier for me so far than modifying the reports to list only selected items.

The list by item is best for answering questions such as "Did you remember the film?" or "Is anyone bringing pepper?" I tend to use this list more as an index to the others than for actual packing or planning, but it's easy enough to run it off as well. Once I've done most of my packing, though, that list usually gets thrown away.

The list by packing location is the one that I try to take along with me. Even on a day hike, where everything

▶ **Making packing lists before taking even a one-day trip is the best use of computers for traveling that I've found so far.**

goes into one pack, it still is a help to know exactly what went into the first-aid kit or which pocket contains the bottle opener.

If making a database sounds like too much trouble, especially for small day trips with adults only, you can get most of the same benefits by typing your lists with a word processor. Again, the ability to build on your cumulative experience is the key. If you update your list each time, based on experience, you find after the first or second trip that it takes far less time to go through that process than to make a list by hand, and the packing certainly becomes less a source of anxiety.

Don't Forget to Write

The other travel database that I keep on my computer is a list of potential postcard recipients and their addresses. The actual writing of postcards doesn't take very long—it's getting organized that's the hassle. I find that if I'm not careful, I come back from a trip with half a dozen postcards that I've written but haven't been able to address or mail. Having the addresses all ready and organized cuts down on that tendency.

Note that I take only the addresses with me. Personally, I'd consider it a gross abuse to use a form letter and mail-merge program to write computer postcards instead of individual messages. The only further step in postcard automation that I might go for would be to print out the names and addresses I'd need on sticky labels, as a further inducement to get the cards completed and sent out.

**It doesn't matter which
Apple Computer you use...**

- Apple IIc
- Apple IIe
- Apple II+

- Apple-Compatible Machine

**It doesn't matter which
Word Processor* you have...**

- AppleWorks
- Bank Street Writer
- Magic Window
- WordStar
- Screen Writer
- Letter Perfect
- Write Away

- AppleWriter
- PFS:WRITE
- Super-Text
- Format II
- Homeword
- Word Handler
- And More!

*AppleWorks and other ProDOS based word processors require Sensible Speller ProDOS.

**It doesn't
matter because
Sensible Speller™
works with them
all!**

Sensible Speller, now available in the ProDOS and original "IV" version, is compatible with the particular Apple hardware and software you already have*. And, more important, it is designed to meet your needs!

You will not be embarrassed any longer by misspellings which can destroy the credibility of your documents, reports and other important papers. **Sensible Speller** catches your spelling mistakes with tireless efficiency. What's more, it displays misspelled words in context, suggests correct spelling, and allows immediate replacement of misspelled words with correct ones.

Of course, a spelling checker is only as good as its vocabulary. And that's why **Sensible Speller** is so excellent; it comes with the 80,000 word vocabulary of the official Random House Dictionary and it provides for adding thousands of more words on disk.

Black's Law Dictionary™, Sensible Technical Dictionary™, and Stedman's Medical Dictionary™ are available separately on diskette.

Shouldn't you have a **Sensible Speller**, the most popular of all spelling checkers? It is available at your dealer for \$125 in the ProDOS or original "IV"* version or order direct, enclosing \$1.25 for shipping. Visa/MasterCard/Check/COD welcome.

*Sensible Speller ProDOS works with the following word processors: AppleWriter-ProDOS version, AppleWorks (Apple Computer, Inc.), Format II Enhanced-ProDOS (Kensington Microware), and others. Sensible Speller IV works with DOS 3.2 and DOS 3.3: AppleWriter (Apple Computers, Inc.), Bank Street Writer (Brodabund), Format II (Kensington Microware), HomeWord & Screen Writer (Sierra On-Line Inc.), PFS:WRITE (Software Publishing, Inc.), Word Handler (Silicon Valley Systems), CP/M-Wordstar (Digital Research Corp.-Micropro International), and others. All features are not available with CP/M, PFS:WRITE & Word Handler. Owners of trademarks indicated in parentheses. Sensible Speller and Sensible Software are trademarks of Sensible Software, Inc.

Apple is a trademark of Apple Computer, Inc.

 **Sensible
Software, Inc.**

210 S. Woodward, Suite 229,
Birmingham, MI 48011
(313) 258-5566

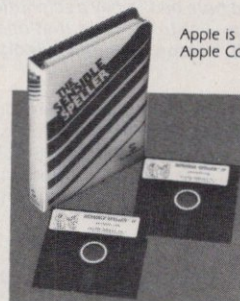

CIRCLE 173 ON READER SERVICE CARD

MasterChart!

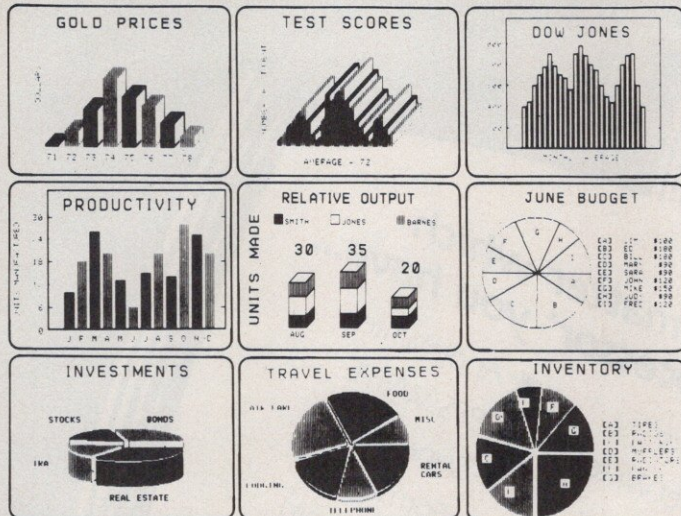

Don't pay more for less! The pictures shown above are examples of charts created with MasterChart!, perhaps the most powerful and friendly Apple II chart program on the market. Within seconds, keyboard-entered data can be converted into picture-perfect pie or bar charts, in 26 user-selectable styles, automatically scaled and labelled, and in color or black and white. And if you want to customize your charts by adding extra artwork or text, or display them in a slide show, MasterChart! comes with these valuable extras

A **slide projector**, for orchestrating automated, stand-alone screen presentations of a series of charts, timed and sequenced by the user. This program alone is worth the cost of the disk. It can be used with any graphics files created with any program.

A **graphics editor**, for alteration and embellishment of charts. Besides standard point-by-point sketching, built-in structures permit push-button creation of circles, rectangles, lines, shape-table shapes, and exotic woven plaid patterns. If you wish to add clarifying text to the charts, you may type on the screen in several different letter font styles. For the artist, the graphics editor can also be used to sketch any imaginable scene from scratch.

A **shape table editor**, for creating special shapes for your charts. These shapes can also be used for animation in your programs! A sample animation program shows how to do it.

MasterChart! includes a screen-dump program for printing your charts on paper. MasterChart! is more! Just read what these people have to say about it . . .

"I noticed the advertisements for Spectral Graphics' Master Chart! program and figured that, with a money-back guarantee, I would try it. Boy, am I glad I did! This is a fantastic program. You can master its many varied capabilities in less time that it would take to describe them. I would recommend it to everyone, even if you have absolutely no need for a graphing program. It's just fun to play with." S.A. Smith, San Bernadino, Calif. . . letter to SOFTALK, June, 1984, page 14.

"The software does much more than the advertisement suggests. Without question, this is among the best buys in software that I have ever come across, and certainly among the best written. It is extraordinarily easy to use, very well thought out, and priced to kill your competition (which I wish you every success in doing)." Anthony J. Scriffignano, North Caldwell, New Jersey.

"I have long been distressed by the lack of software available in the scientific/academic community. At last there is a simple yet robust graphics program applicable for our purposes: MasterChart!, by Spectral Graphics Software. Business folks and scientists alike will really appreciate how user-friendly it is; I was able to produce my first three-dimensional, multi-colored, labeled bar graph within five minutes of booting the disk—without reading my documentation. I would have had to pay a scientific illustrator much more than the whole program costs just to produce that one graph. . . you can't do without this gem." John B. Iverson, Richmond, Indiana. . . letter to SOFTALK, April, 1984, page 23.

ONLY \$29.95 Apple II+//IIe/IIc. Satisfaction guarantee or your money back (really!). Send a check or purchase order to **SPECTRAL GRAPHICS SOFTWARE**, 6333 Pacific Avenue, Suite 256, Stockton, California 95207. Or call (209) 463-7309 for COD orders and dealer inquires. MasterChart! is not yet sold in most stores. All orders are shipped immediately and are in your hands within three days.

CIRCLE 109 ON READER SERVICE CARD

Of course, you don't have to go away to write postcards. I've been thinking of making some of my own backyard messages this summer for a bit of that down-home touch. I thought I'd try taking a photograph or two; capturing the results with Thunderscan for the Macintosh; and then adding the rest of the borders, captions, and so forth with MacPaint. You can do the same on the IIe or IIc, using a program such as The Print Shop for output.

If you get serious about postcards, you can buy "bristol" stock paper in continuous forms with perforations to snap out postcard-size sheets. Normal paper won't make it through mail-sorting machines, and if you start with a postcard-size piece of stiff paper, you'll have trouble feeding it through an Imagewriter or similar printer. Before I found the continuous forms, I used to print my postcards on full-size sheets of bristol and then cut them to size along lines I included in the design to mark the edges.

Live and Learn

Among book readers, summertime is traditionally the time to read something new, out of the ordinary, or off in a different direction. That's not a bad idea for computerized

If you're using your Apple for help with academic studies, your summer break might be the moment to explore some new possibilities.

education either. If you're using your Apple for help with academic studies, your summertime break might be the moment to explore some new possibilities.

As during the rest of the year, instructional software varies widely in quality, and an approach that works for your neighbor might not be the best for you. Generally, programs that ask you for more input than "yes," "no," or a choice from a menu are best—especially on a warm summer evening, a program has to invite your full participation to hold your interest.

If serious education sounds too formidable, you might want to try some interactive fiction as the computer equivalent of the book world's light summer fare. In computerized fiction, your choices become one of the factors that determine how the story unfolds. So far, most interactive fiction seems to be genre stories, such as detective novels, science fiction, or period adventures, but you'll find a wide and growing range of topics and authors.

Of course, there's no rule that says you can't play normal computer games during the summer, and, if you have kids, some of the better games may keep them amused for hours on end. Just as any other kind of addiction or imbalanced diet takes a toll in the long run, however, too much time spent hunched over a joystick isn't good for either children or adults.

Fortunately, computers are still a long way from possessing any feelings of jealousy. You can take a few weeks off from your Apple without any recriminations or bad feelings. A personal computer can be useful, fascinating, and entertaining, but there's more to life than what shows up on the screen. You'll like your Apple even more if you give yourself a chance to miss it now and then. +

Steve Rosenthal still has a 40-foot keyboard extension cable he made up a few summers ago. He tries not to let his computers keep him on too short a leash.

CONROY-LA POINTESM INC.

© 1984, 1985 by Conroy-LaPointe, Inc. All Rights Reserved

LOW PRICES TO PROFESSIONALS WHO KNOW WHAT THEY WANT AND KNOW HOW TO USE IT!

TELEX 910 380 3980

ALL MAIL: Conroy-LaPointe, Inc.
12060 SW Garden Place, Portland, OR 97223

TO ORDER, CALL (800) 547-1289

FOR YOUR APPLE



MACINTOSH

	LIST PRICE	CONROY PRICE
AEGIS, Challenger or Pyramid, ea.	\$ 50	\$ 33
ASSIMILATION, Turbo Touch	\$ 129	\$ 89
BLUECHIP, Millionaire, Barron Tycoon, ea.	\$ 60	\$ 38
CENTRAL POINT, Copy II Mac or MacTools, ea.	\$ 40	\$ 24
CONROY-LA POINTE, Diskettes	SEE BELOW	
CONTINENTAL, Home Accountant	\$ 100	\$ 65
CREATIVE SOLUTIONS, MacForth Level I	\$ 149	\$ 95
CREIGHTON, Home Pak or Mac Office, ea.	\$ 39	\$ 26
Mac Spell +	\$ 99	\$ 60
CSD, MacLion	\$ 379	\$ 239
DOW JONES, Market Manager Plus	\$ 249	\$ 159
EXPERTELLENCE, ExperLogo	\$ 150	\$ 95
FIRST BYTE, Smooth Talker	\$ 150	\$ 95
FORETHOUGHT, Fact Finder	\$ 150	\$ 95
HABA, DS/DD Ext. Disk Drive, 800K	\$ 795	\$ 479
HAYDEN, Sargon III	\$ 50	\$ 31
HIPPOTAMUS, Hippo C, Level I	\$ 150	\$ 99
HUMAN EDGE, Mind Prober	\$ 50	\$ 29
INFOCOM, Hitchhiker's Guide	\$ 40	\$ 25
KOALA, Mac Vision	\$ 400	\$ 229
LIVING VIDEOTEK, Think Tank	\$ 145	\$ 83
LOTUS, Jazz	\$ 595	\$ 395
MEGAHAUS, Megaform	\$ 295	\$ 185
MICROSOFT, Business Pak	\$ 595	\$ 255
Excel	\$ 395	\$ 259
Multiplan, Word, or File, each	\$ 195	\$ 125
MILES, Mac the Knife, v. 1	\$ 39	\$ 25
MONOGRAM, Dollars & Sense	\$ 150	\$ 89
NOVATION, Smartcat Plus Modem w/Software	\$ 499	\$ 349
ODESTA, Helix	\$ 395	\$ 259
PROVUE, Overview	\$ 295	\$ 185
SIMON & SCHUSTER, Typing Tutor III	\$ 60	\$ 37
SOFT. PUBL., PFS: File & Report Combo	\$ 175	\$ 105
SOFTWARE ARTS, T/K Solver	\$ 249	\$ 159
STATE OF THE ART, Electronic Checkbook	\$ 80	\$ 50
STONEWARE, DB Master	\$ 195	\$ 125
TELOS, File Vision	\$ 195	\$ 115
VIDEX, MacCalendar	\$ 89	\$ 49
WARNER, Desk Organizer	\$ 89	\$ 49

COMPUTERS

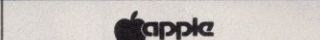

Apple logo

lle, llc, Mac IN STOCK, CALL

FLOPPY DISK DRIVES

	LIST PRICE	CONROY PRICE
MICRO-SCI, A2 Disk Drive, 143K	\$ 345	\$ 163
A2 Controller Card	\$ 100	\$ 60
Half Height Drive for II + /lle	\$ 269	\$ 169
Half Height Drive for llc	\$ 299	\$ 189
RANA, Elite I, 163K, 40 Track	\$ 299	\$ 189
Elite Controller	\$ 145	\$ 79
TEAC, T40 Half Ht, 163K, Direct	\$ 249	\$ 159
Controller Card for T40 by ComX	\$ 79	\$ 45

HARD DISKS

QUARK, QC10 for llc/lll/llll/MAC	\$1995	\$1595
----------------------------------	--------	--------

OTHER HARDWARE

APPLIED ENGINEERING, Ram Works, 64K	\$ 179	\$ 139
CCS, 7711 or 7710-A Interface, ea.	\$ 115	\$ 85
CPS/EASTSIDE, Wild Card II (copier, +)	\$ 140	\$ 79
COMX, 16K RAM Card (II +), 1 yr ltd wty	\$ 119	\$ 29
HAYES, Mach II, III Joysticks (II + /lle)	CALL	
KENSINGTON, System Saver Fan	\$ 90	\$ 65
KEY TRONIC, KB200 Keyboard (+)	\$ 298	\$ 179
KOALA, Muppet Keys	\$ 80	\$ 44
Touch Tablet w/Micro Illustrator (+)	\$ 130	\$ 75
KRAFT, Joystick (llll + /lle)	\$ 50	\$ 35
MICRO-SCI, 80 Col. Card + 64K RAM Card (lle)	\$ 199	\$ 89
MICROSOFT, Premium Softcard (lle)	\$ 395	\$ 275
Z80 Softcard II, 64K	\$ 425	\$ 295
ORANGE MICRO, Buffered Grappler Plus, 16K	\$ 209	\$ 159
16K Buffer Board for Grappler Plus	\$ 99	\$ 59
PCPI, Applcard, 6 MHz, 14 features	\$ 375	\$ 250
TITAN, Accelerator lle	\$ 319	\$ 219
128K RAM Card (II +)	\$ 329	\$ 149
TRACKHOUSE, Numeric Key Pad (lle)	\$ 100	\$ 50
VIDEO 7, V Color 7 RGB Card	\$ 150	\$ 99
V Color Ie	\$ 200	\$ 139
V Color Iie	\$ 250	\$ 169
VIDEX, UltraTerm (II + /lle)	\$ 299	\$ 189
VideoTerm 80 Col. Card (II + /lle)	\$ 279	\$ 175
WICO, Smartcard (spec. III + /lle)	\$ 199	\$ 159

BUSINESS SOFTWARE

	LIST PRICE	CONROY PRICE
ALS, Word or List Handler, ea.	\$ 80	\$ 36
Handler Pak (Word/List/Spell)	\$ 170	\$ 73
APPLE, Apleworks	\$ 250	\$ 215
ASHTON-TATE, dBase II (Req CP/M 80)	\$ 495	\$ 289
BPI, AR, AP, PR or IV, each	\$ 395	\$ 240
BRODERBUND, Print Shop	\$ 50	\$ 29
Print Shop & Refill	\$ 65	\$ 39
Bank St. Writer or Speller, ea.	\$ 70	\$ 45
Bank St. Combo (Writer & Speller)	\$ 140	\$ 85
DATA TRANS, Fontrix	\$ 95	\$ 55
DOW JONES, Market Manager	\$ 249	\$ 159
Market Analyzer or Microscope, ea.	\$ 349	\$ 219
HOWARD SOFT, Tax Preparer 85	\$ 250	\$ 159
HUMAN EDGE, Sales or Mgmt Edge, ea.	\$ 250	\$ 165
LIVING VIDEOTEK, Think Tank	\$ 145	\$ 89
MECA, Managing Your Money	\$ 199	\$ 125
MEGAHAUS, Megaworks	\$ 125	\$ 80
MICRO PRO, WordStar (req. CP/M)	\$ 350	\$ 189
WordStar w/ Starcard	\$ 495	\$ 265
WordStar Professional, 4 Pak	\$ 495	\$ 265
MailMerge, SpellStar, or StarIndex, ea.	\$ 99	\$ 54
InfoStar and StarCard Combo	\$ 595	\$ 295
MICROSOFT, Multi-Plan (Ap DOS)	\$ 95	\$ 62
QUARK, Word Juggler & Linccheck (llc/ll)	\$ 189	\$ 129
SENSIBLE, Sensible Speller	\$ 125	\$ 79
SIERRA/ON-LINE, Screen Writer II	\$ 130	\$ 79
SOFTWARE PUBL., PFS: File or Write, each	\$ 125	\$ 79
PFS:Graph or Report, each	\$ 125	\$ 79
PFS:Access	\$ 70	\$ 43
SPRINGBOARD, Newsroom	\$ 50	\$ 32
STONEWARE, DB Master, v. 4 +	\$ 350	\$ 225

UTILITIES SOFTWARE

	LIST PRICE	CONROY PRICE
EPSON, Graphics Dump	\$ 15	\$ 7
FUNK, Sideways	\$ 60	\$ 37
HAYES, Terminal Prog. for Smartmodem	\$ 99	\$ 65
MICROSOFT, Full Line IN STOCK	CALL	
OMEGA, Locksmith	\$ 100	\$ 70
PENGUIN, Complete Graphics System II	\$ 80	\$ 49
Graphics Magician	\$ 60	\$ 40
QUALITY, Bag of Tricks	\$ 40	\$ 29
UNITED SWI, ASCII Express-Pro DOS	\$ 130	\$ 82
UTILICO, Essential Data Duplicator III	\$ 80	\$ 49

HOME & EDUCATIONAL

	LIST PRICE	CONROY PRICE
BEAGLE BROS., Full Line IN STOCK	CALL	
BRODERBUND, Print Shop	\$ 50	\$ 29
CONTINENTAL, Home Accountant	\$ 75	\$ 43
KOALA, Full Line IN STOCK	CALL	
MICROSOFT, Typing Tutor II	\$ 25	\$ 17
MONOGRAM, Dollars & Sense (II + /lle)	\$ 100	\$ 59
Dollars & Sense (llc/llie 128K)	\$ 120	\$ 69
Forecast	\$ 60	\$ 38
SCARBOROUGH, Mastertype	\$ 40	\$ 25
Build-A-Book	\$ 40	\$ 25
Your Personal Net Worth	\$ 80	\$ 50
SIERRA/ON-LINE, Homework	\$ 70	\$ 45
SIMON & SCHUSTER, Typing Tutor III	\$ 60	\$ 37
PLUS: BARRONS, CBS, DAVIDSON, EDU-WARE, HARCOURT, LEARNING CO., TERRAPIN		

RECREATIONAL SOFTWARE

	LIST PRICE	CONROY PRICE
BLUECHIP, Millionaire or Barron, ea.	\$ 60	\$ 39
DATASOFT, Aztec or Zaxxon, each	\$ 40	\$ 27
ELECTRON. ARTS, Sky Fox & others, ea.	\$ 40	\$ 29
HAYDEN, Sargon III (Chess)	\$ 50	\$ 30
INFOCOM, Zork I, II, or III, ea.	\$ 40	\$ 25
ORIGIN, Ultima III	\$ 60	\$ 37
PENGUIN, Transylvania	\$ 35	\$ 24
SPECTRUM HOLOBYTE, Gato	\$ 40	\$ 25
SPINNAKER, Full Line IN STOCK	CALL	
SUB LOGIC, Flight Simulator II	\$ 50	\$ 30
PLUS: BRODERBUND, DATAMOST, MUSE, SIR-TECH		

DISKETTES

★ CONROY-LAPOINTE™ DISKETTES ★
We guarantee these top quality products with our name.
5 YEAR LIMITED WARRANTY.

10 ea. SS/SD, (Apple, etc) 35 Trk, W/FLIP BOX	\$ 12
100 ea. SS/SD, (Apple, etc) 35 Trk	\$ 99
100 ea. SS/SD, (Apple, etc) 35 Trk	\$ 840
10 ea. SS/DD, 3 1/2" (MAC, H/P), W/FLIP BOX	\$ 25
50 ea. SS/DD, 3 1/2" (MAC, H/P)	\$ 115
100 ea. SS/DD, 3 1/2" (MAC, H/P)	\$ 229

SINGLE-SIDED, DOUBLE DENSITY

	LIST PRICE	CONROY PRICE
CDC, 10 ea. SS/DD, 40 Trk (Apple, etc)	\$ 45	\$ 19
DYSAN, 10 ea. SS/DD, (Apple, etc)	\$ 40	\$ 27
MAXELL, 10 ea. SS/DD, MD1 (Apple)	\$ 47	\$ 19
VERBATIM, 10 ea. SS/DD, MD515-01, (Apple)	\$ 49	\$ 19

3 1/2" MICRO DISKETTES

CONROY-LAPOINTE, 10 ea. DS/DD, w/Flip Box	\$ 29
MAXELL, 10 ea. SS/DD (MAC, H/P)	\$ 60
MEMOREX, 10 ea. SS/DD (MAC, H/P)	\$ 60
VERBATIM, 10 ea. SS/DD (MAC, H/P)	\$ 65

★ GENERIC DISKETTES ★

Top quality, w/jackets, no labels. Quantity discounts.
90 day "No hassle, money back guarantee."

10 ea. SS/SD, 35 Track (Apple, etc)	\$ 10
100 ea. SS/SD, 35 Track (Apple, etc)	\$ 80
100 ea. SS/SD, 35 Track (Apple, etc)	\$ 750
10 ea. DS/DD, 40 Track, (IBM, H/P)	\$ 12
100 ea. DS/DD, 40 Track, (IBM, H/P)	\$ 95
1000 ea. DS/DD, 40 Track, (IBM, H/P)	\$ 829

MODEMS

	LIST PRICE	CONROY PRICE
ANCHOR, Signalman Mark XII	\$ 399	\$ 259
HAYES, 2400 External Modem	\$ 899	\$ 407
Smartcom II Software (IBM or MAC)	\$ 149	\$ 107
Smartmodem 120 (External)	\$ 599	\$ 419
Micromodem IIe w/Smartcom (AP)	\$ 199	\$ 139
Transet 1000 - 128K	\$ 399	\$ 309
NOVATION, Apple Cat. 1200 Baud (AP)	\$ 399	\$ 319
212 Apple Cat. 1200 Baud (AP)	\$ 595	\$ 409
SmartCat Plus w/software (MAC)	\$ 499	\$ 349
PROMETHEUS, 1200 Standalone Modem	\$ 495	\$ 345
ProModem 1200 w/software (MAC)	\$ 549	\$ 389
ProModem 1200A (AP)	\$ 449	\$ 319

MONITORS

AMDEK, Color 300 - Comp/Audio	\$ 349	\$ 249
Color 500 - Comp/VCR/RGB/Audio	\$ 525	\$ 319
Color 600 - Hi Res/RGB/Audio	\$ 599	\$ 399
300A - 12" Amber/Comp	\$ 199	\$ 119
300G, 12" Green/Comp	\$ 179	\$ 115
PRINCENTON, HX-12 - Hi Res/RGB	\$ 795	\$ 489
SR-12 - Hi Res/RGB	\$ 799	\$ 599
QUADRAM, Amberchrome, 12"	\$ 250	\$ 159
ZENITH, ZVM122 - 12" Amber	\$ 159	\$ 89
ZVM123 - 12" Green	\$ 149	\$ 85
ZVM124 & ZVM 135	20-30% OFF	

CABLES

ASTAR, RF Modulator for T. V. (Apple)	\$ 35	\$ 20
COMPCABLE, MacHayes Smartmodem Cable	\$ 32	\$ 25
RCA, Monitor Cable	\$ 15	\$ 9

PRINTERS

	LIST PRICE	CONROY PRICE
APPLE, Imagewriter	CALL	
Laserwriter	\$6995	\$6500
EPSON, RX / FX Series - IN STOCK	CALL	
LX80 - 100 cps DQ/16 cps NLQ	\$ 299	\$ 249
JX80 - Color Printer, 160 cps	\$ 699	\$ 449
LQ1500 - 200 cps DQ/67 cps LQ	\$1295	CALL
OKIDATA, Okimate 20 - Color, Hi Res	\$ 268	\$ 208
182 - 120 cps/80 col	\$ 295	\$ 239
192 - 160 cps/80 col/para. NEW	\$ 499	\$ 349
93 - 160 cps/136 col/para.	\$ 799	\$ 589
2410 Pacemaker - 350 cps/para.	\$2995	\$1975
PANASONIC, P1090 - 80 cps/10"	\$ 349	\$ 249
P1092 - 180 cps/10"	\$ 599	\$ 459
QUADRAM, Quadjet - Inkjet Color	\$ 895	\$ 595
STAR MICRO, SG10 - 120 cps DQ/30 cps NLQ	\$ 299	\$ 249
SG15 - 120 cps DQ, 30 cps NLQ, 16K	\$ 499	\$ 419
SD10 - 160 cps DQ, 40 cps NLQ	\$ 449	\$ 379
SD15 - 160 cps DQ, 40 cps NLQ, 16K	\$ 599	\$ 509
SR10 - 200 cps DQ, 50 cps NLQ	\$ 649	\$ 549
SR15 - 200 cps DQ, 50 cps NLQ, 16K	\$ 799	\$ 679
TOSHIBA, 151 - 288 cps	\$1895	\$1369

LETTER-QUALITY:

JUKI, 6300 - 40cps/para.	\$ 995	\$ 695
6100 - 18 cps/para/3 pitch	\$ 599	\$ 369
Sheet Feeder for 6300 (single)	\$ 275	\$ 225
PANASONIC, P3151 - 22 cps/15 1/2"	\$ 699	\$ 539
TOSHIBA, Prop. spacing & hi-res graphics:		
1351 - 192 cps DQ & 100 cps LQ	\$1895	\$1369
1340 - 144 cps DQ & 84 cps LQ	\$ 799	\$ 619
Bi-direction Tractor Feed	\$ 195	\$ 175

PRINTER INTERFACES AND BUFFERS

	LIST PRICE	CONROY PRICE
ASSIMILATION, Mac to Epson Conn I/F	\$ 89	\$ 69
Daisywheel Connection	\$ 99	\$ 79
EPSON, Parallel Interface for LQ1500	\$ 100	\$ 79
Serial Interface Board	\$ 130	\$ 110
OKIDATA, Plug-n-Play, Tractors, Okigraph	CALL	
ORANGE MICRO, Grappler Plus for Apple	\$ 145	\$ 99
Serial Grappler	\$ 119	\$ 79
Buffered Grappler Plus, 16K	\$ 209	\$ 159
Hot Link Cable, S-P for Iie	\$ 70	\$ 44
Grappler C	\$ 119	\$ 75
QUADRAM, Microfazers, Full Line IN STOCK	CALL	
Microfazers 8K, P-P, w/copy	\$ 189	\$ 139
SMT, Apple II I/F & Cable	\$ 89	\$ 39
STAR MICRO, Serial I/F & Cable	\$ 144	\$

EMCO

**FREE PEN WATCH FOR
ORDERS OVER \$50.00**

(805) 499-6871

FACTORY GUARANTEED QUALITY

DETACHED KEYBOARD

\$95.00

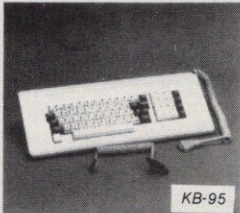

- Apple-Franklin compatible
- Programmer keyboard
- Enhance over 40% of keyboard functions
- Microprocessor control with Upper/Lower case
- 42 function keys
- 3 user-programmable keys
- Standard numeric key pad
- Power "ON" light
- Curly-cord connector and connector mate included

S & H \$5.00

5 1/4" DISKETTES

ONLY \$1 EACH

by ULTRA MAGNETICS
SS/DD G-Neric diskettes
w/hub rings, sleeves & write
protect tab (pkg. of 20)

\$20

FREE DISK DOUBLER
with purchase of 100 pcs Diskettes

S & H \$3.00

(Note: \$3.00 Shipping & Handling required on all diskette orders)

FLIP 'N' SORT

\$14.95

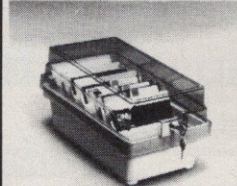

- Elegant appearance
- Key lock for file integrity
- Smoke top w/beige base
- Protect up to 100 5 1/4" diskettes
- Ten movable dividers
- Non-slip guides keep disks upright and flat

DX-85A

S & H \$4.50

ADJUSTABLE MONITOR STAND

\$12.95

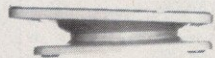

- Tilts and swivels display
- Rotates 360°
- Tilt-angle adjustable and lockable
- Rubber pads on top and bottom guarantee no slipping
- Holds all size monitors

S & H \$4.50

JOY STICKS

\$17.95

HAND HELD



- Apple II + , IIe, IIc, or IBM pc compatible
- Self-centering w/metal handle
- Adjustable verticle and horizontal
- Hand-held model with AutoFire
- Please specify II + , IIe , IIc or IBM pc on order

S & H \$4.00

FLIP 'N' CARRY

\$11.95

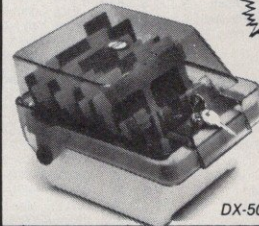

- Built-in carrying handle
- Elegant appearance
- Key lock for file integrity
- Smoke top w/white base
- Protect up to 50 5 1/4" diskettes
- Four movable dividers
- Non-slip guides keep disks upright and flat
- 6 1/2" H, 8 3/4" L, 7" W

DX-50A

S & H \$4.50

IBM COMPATIBLE

TEAC 55B - 1/2 Height, DS/DD Drive \$130

I² INTERFACE - 10.6 MB, Low Power Internal Winchester Disk System . . . \$645

I² INTERFACE - 10.3 MB Backup Tape for IBM/pc with one free tape . . \$625
Tape only \$35

I² INTERFACE - 21.1 MB, 1/2 Height Winchester for IBM pc/AT Upgrade Kit \$799

DISK DOUBLER

\$9.95



- Accurate position guide
- Hand-held compact design
- Square notch-cut
- Sturdy, all-metal construction

S & H \$4.00

COOLING FAN

\$29.95

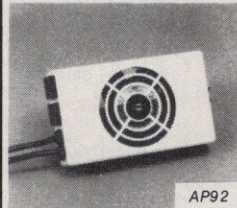

- New super-thin design
- Adjustable: fits all cases
- Dual outlets for monitor and printer
- Heavy duty switch w/power on pilot light
- Built-in power surge protection
- Also fits Commodore model 1541 drive

AP92

S & H \$4.00

RF MODULATOR SET

\$9.95

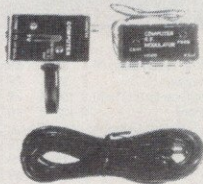

- RF Modulator
- TV Interface
- Coaxial Cable

S & H \$4.00

EXTERNAL PORT

ONE PORT **\$4.95**
FOUR PORT **\$12.95**



- Apple II + I/O extender
- Easy access to I/O
- One-port or four-port available
- Control by individual switch

S & H \$4.00

VIDEO 'FLIPPER'

\$9.95

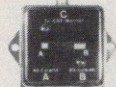

- Easily flips from 40 to 80 column mode and back
- One computer to two monitors connection and select
- Two computers to one monitor connection and select

S & H \$4.50

ANTI-GLARE PANEL

\$29.95



- Fit 12" to 14" Video Display Terminals
- Reduce Glare from VDTs on color and monochrome screens
- Enhance the contrast between image and background.
- Easy mounting

S & H \$4.00

FLOPPY DISK DRIVE HALF-HEIGHT

\$145

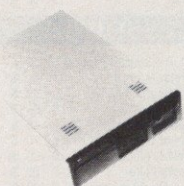

- Apple compatible 5 1/4"
- 250 KB disk capacity (unformatted)
- High-speed (6 ms) access time
- 149 x 45 x 230 mm
- Made in Japan

S & H \$6.00

MONITORS

\$100

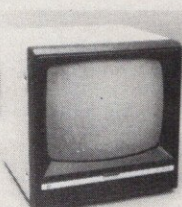

AMBER :

- Amber HI-RES monitor
- 12" display
- Non-glare screen finish
- 20 MHz
- 1000 lines @ center

\$225

COLOR :

- Color/Green selectable
- 14" display
- Audio/video input
- Audio/video output
- Volume control

S & H \$13.00

APPLE™ COMPATIBLE

\$199.00

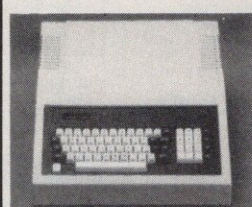

INCLUDES (as shown):

- CASE: ABS case in light beige, w/spacer for easy motherboard mounting.
- KEYBOARD: Same features as KB-95 (above) exc. assembled in case for easy mother BD connection.
- SWITCHING P.S.: 110/220 select, 5V/5A, 12V /2.5A, -12V/5A, -5V/5A; in case w/power cord and connector.
- RF MOD. SET: RF modulator, coaxial cable, TV interface.
- SPEAKER: Mounted w/cable and plug.

CK 199

S & H \$12.00

• WANTED • DEALERS • DISTRIBUTORS •

EMCO (805) 499-6871

3541 OLD CONEJO ROAD, SUITE 111
NEWBURY PARK, CA 91320

PRICES AND AVAILABILITY SUBJECT TO CHANGE WITHOUT NOTICE

**VISA
MASTERCARD
ACCEPTED**

Please add on 4%
for VISA or MasterCard
orders.

TERMS:

- Cashier's check or money order only
- FREE S & H charges for prepaid orders
- C.O.D. orders please add on S & H charges
- California residents please add 6% sales tax
- 10% restocking charge for orders returned or refused
- Extra S & H charges for outside U.S.A.

GUARANTEE: 90 days DELIVERY: UPS, stock to 4 weeks

DOT-MATRIX

► APPLEWORDS BY STEVE ROSENTHAL

A short glossary of terms for use with 'Dot-Matrix Printers,' page 26-36

BIDIRECTIONAL PRINTING

The practice of printing lines from right to left as well as the normal left to right. This procedure speeds printing, but it provides less precise registration than if all lines are printed unidirectionally. The Apple Imagewriter normally prints bidirectionally, unless you instruct it to print in one direction only.

BUFFER

A region of memory that stores characters and other codes until the printer is ready to process them. Most printers have a built-in buffer of 80 to several thousand characters, and you can buy external printer buffers with even larger capacities.

CHARACTER PITCH

Although, strictly speaking, it designates the distance between successive characters, the term is usually taken as the number of characters in an inch. Typically, personal-computer printers run at approximately 5, 10, and 15 characters per inch, with other values available in compressed, expanded, or double-width modes. For printing proportional typesets, where letters occupy varying spaces, an average pitch may be cited or the dot pitch or minimum size increment may be specified instead.

CONTROL CODE

A character or sequence of characters that activates a printer function or sets a mode, rather than printing out on the page. Generally, printers use a combination of control characters (the 32 nonprinting characters included in the ASCII character code) and multicharacter "escape sequences" made up of groups starting with the character produced by CHR\$(27). Control codes are not standardized, which is why software needs a special printer driver to produce the codes needed by each different printer.

cpi

An abbreviation for *characters per inch*. Ten characters per inch is normal for computer printers, a spacing also known as pica size. The Macintosh uses proportionally spaced rather than fixed-size characters, so the average cpi depends on the typeface, point size, and even the content of the text. See *character pitch* for more details.

cps

An abbreviation for *characters per second*, a figure that frequently characterizes the operating speed of printers. Daisy-wheel printers run at about 10 cps, dot-matrix printers from 40 to several hundred. A page printer such as the LaserWriter takes the same time to produce a page, no matter how many characters are used, giving it a print speed of up to several hundred cps. Most published cps figures are substantially higher than the values actually typical in field use.

DIP SWITCHES

Small switches on printers and interfaces for setting operating modes or default conditions. DIP stands for dual in-line package, which refers to the size and arrangement of the switch connections.

DOT-MATRIX PRINTER

A printer that forms each character out of a pattern of small dots arranged in a grid array. The Imagewriter is an impact dot-matrix model, the Scribe a thermal transfer, and the LaserWriter a laser electrographic unit. The only common non-dot-matrix printing technology is the daisy-wheel.

DOUBLE-STRIKE

A printing mode that makes each character darker by printing it twice. On some printers, particularly dot-matrix models, the second impression is placed a single dot position below the first, a procedure that requires two passes of the printhead.

DOWNLOAD

To send a printer a set of tables telling it how to construct specified characters. This procedure allows the printer to show special symbols, other alphabets, or character graphics. The Imagewriter can store up to 175 such custom characters, the LaserWriter several thousand.

DPI

An abbreviation for *dots per inch*, a measure of how closely a printer can pack the dots it uses to produce characters. The Apple Imagewriter, for example, runs at up to 160 DPI, the LaserWriter at 300 DPI.

EPSON-COMPATIBLE

Said of a printer that imitates the response of the Epson MX/RX series to printing characters, graphics, control characters, and escape sequences. Epson printers are the best-selling personal-computer line, so they're often one of the possible settings on programs and interface cards that work with non-Apple printers.

FONT

A set of characters of a given style and usually a stated size. In some contexts, the italicized or bold version of the letters may be included, as may different scalings of the letters; in others only a single size and variation is included. Both the Imagewriter and the LaserWriter can accept new font definitions, allowing them to print in as many fonts as the software can provide.

HEX DUMP

A listing of all the characters sent to a printer in hexadecimal (base 16) form. Some printers offer it as an option to help debug control sequences.

IMAGewriter-COMPATIBLE

Denotes a printer that accepts the same control and character codes as the Apple Imagewriter, producing the same printed result. A few Imagewriter-compatible models are available, and you can make other printers do the job with a software-driver program to do the needed translation.

IMPACT PRINTER

An output device that prints characters by striking dots or character images against a ribbon, pushing ink onto the

paper. The most common in the Apple computer world are impact dot-matrix printers (such as the Imagewriter) and daisy-wheel models (often called letter-quality printers).

INTERNATIONAL CHARACTER SET

A collection of letter forms used in various languages, particularly currency symbols and members of the Roman alphabet with the accents needed for printing various European languages. On the Imagewriter, these are part of the Extended Character Set, which you can select instead of ten normal symbols with either the DIP switches or control sequences. Other printers, including the LaserWriter, include these characters in addition to the normal symbols.

NLQ

An abbreviation for *near letter quality*, the way many printer manufacturers describe the output of their

high-resolution dot-matrix printers. Generally, you can see that these characters are made up of dots if you look closely, but the dots overlap to form solid characters, rather than the characters with highly visible dots that are typical in the "draft" or normal dot-matrix mode.

PARALLEL

Referring to connections between an Apple and printers: sending data as groups of eight bits at a time, with each bit carried by an individual wire in a larger cable. The Apple II, II Plus, and IIe can use parallel interfaces, allowing them to use relatively expensive printers and interface cards. The rest of the Apple family requires a serial interface for printer connections.

PRINTER DRIVER

A software package that translates output intended for a printer into the exact form needed by a particular model. Some software allows you to select from various

built-in printer drivers, and for others you must install the printer driver as a preboot, memory-resident program or desktop icon.

SERIAL

Referring to connections between an Apple and printers: sending data as successive bits down a single wire, usually in groups of seven to ten bits per character. The Apple IIc, Macintosh, Imagewriter, and LaserWriter all use this type of interface, as can other members of the Apple II family. Sometimes this style is known as an RS-232 interface, referring to an industry standard for this type of connection.

SUBSCRIPT AND SUPERScript

Literally, characters printed respectively below or above the normal writing line. Some printers have a special subscript mode that rolls the paper a half line up or down for the formation of these characters, but most Apple-

compatible printers rely on the software to produce the right effect for subscripts or superscripts by issuing paper-movement commands with fractional-line values.

THERMAL-TRANSFER PRINTING

A printing technology that forms an image by melting wax-based ink from a ribbon or transfer sheet onto the paper. The heat comes from small, resistive dots on a dot-matrix printhead, but since the printhead has no moving parts, thermal-transfer printers are quiet and relatively inexpensive.

UNIDIRECTIONAL

Printing in which the printhead moves in only one direction across the page. Laser printers and older impact printers use this method, but most other printers now print bidirectionally. On some models, unidirectional printing is still used for graphics to produce good dot alignment. +



QUALITY APPLE® SOFTWARE

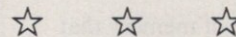

BUSINESS

	LIST	TRIAD
AP, AR, INV. PAY (BPI) (EA)	\$395.00	\$238.00
BACK TO BASICS ACCT (2E)	195.00	110.00
DB.MASTER BUSINESS TEAM	329.00	200.00
FLASHCALC	99.00	61.50
GENERAL ACCOUNTING (BPI)	395.00	238.00
HABA MERGE	69.95	48.50
MEGA WORKS	125.00	75.00
PFS: BESTSELLERS (PFS.FILE, WRITE, REPORT, PLAN—ALL 4)	250.00	155.00
PFS FILE/REPORT/GRAPH (EA)	125.00	73.50
PRO FILER	89.95	61.50
SIDEWAYS (DOS 3.3 ONLY)	60.00	35.95
SUPER CALC 3A (2C/2E ENH)	195.00	118.00
VERSALEDGER II	149.95	102.00
VISICALC PACKAGE	179.00	110.00

EDUCATION

	LIST	TRIAD
ALGEBRA 1/2/3/4 (EA)	\$ 39.95	\$ 22.95
EARLY GAMES - YOUNG CHILD	29.95	21.50
FELONY	34.95	21.95
FRIENDLY FILER	39.95	27.95
GRAMMAR EXAMINER	44.95	28.50
MAKE A MATCH	29.95	18.95
MANY WAYS TO SAY I LOVE YOU	29.95	19.50
MASTER TYPE	39.95	24.50
MATH BLASTER	49.95	30.50
MICKEY'S SPACE ADVENTURE	39.95	24.50
NEWSROOM (SPRINGBOARD)	49.95	30.50
READER RABBIT	39.95	24.50
SNOOPY'S READING MACHINE	39.95	24.95
SPELL-IT	49.95	30.50
STICKYBEAR READING	39.95	24.50
STORY MAKER (SCHOLASTIC)	39.95	24.50
TRAINS	39.95	24.95
TYPING TUTOR III	49.95	30.50
WHERE...IS CARMEN SAN DIEGO?	39.95	24.95
WORD ATTACK	49.95	30.50

WORD PROCESSING

	LIST	TRIAD
BANK STREET SPELLER	\$ 69.95	\$ 41.50
BANK STREET WRITER (64K)	69.95	41.50
BANK STREET WRITER (128K)	69.95	41.50
FORMAT II ENHANCED	150.00	88.50
HANDLER PACK	169.95	102.00
PFS WRITE (2E/2C)	125.00	73.50
SCREENWRITER II PRO	129.95	76.50
SENSIBLE SPELLER (DOS, PRO)(EA)	125.00	73.50
WORD HANDLER V4.0	79.95	48.95
WRITE CHOICE (WAGNER)	44.95	27.50

HOBBY

	LIST	TRIAD
ALPHA PLOT (DOS 3.3)	\$ 39.50	\$ 21.50
APPLE MECHANIC (DOS 3.3)	29.50	16.50
BEAGLE BASIC (REQ 64K)	34.95	19.50
BEAGLE GRAPHICS (REQ 128K)	59.95	31.95
C.I.A. (GOLDEN DELICIOUS)	65.00	44.95
COPY II PLUS (VER 5.0)	39.95	22.50
D.CODE (BEAGLE)	39.95	22.50
DISK QUIK (2C/2E-128K)	29.50	16.50
DOS BOSS (DOS 3.3)	24.00	13.95
DOUBLE TAKE (DOS & PRODOS)	34.95	19.50
EXTRA-K (BEAGLE)	39.95	22.50
FAT CAT (DOS & PRODOS)	34.95	19.50
FONTRIX (DATA TRANSFORMS)	95.00	56.95
FONTPAK #1/2/3/4/5/6/7/8/9/10/11 (EA)	25.00	16.50
GPLE (DOS & PRODOS)	49.95	26.95
GRAPHICS MAGICIAN	59.95	36.50
MACROSOFT & ASSEMBLER	99.95	81.50
MASTER DIAGNOSTICS	65.00	39.95
MERLIN PRO	69.95	41.50
PRO BYTER (BEAGLE)	34.95	19.50
PRODOS ORCA/M (NEW)	79.95	49.95
PRONTO DOS (DOS 3.3)	29.50	16.50
SILICON SALAD (DOS 3.3)	24.95	13.95
TAKE 1 (BAUDVILLE)	59.95	36.95
TIP DISK #1, TYPEFACES (EA)	20.00	11.50
TRIPLE-DUMP (DOS & PRODOS)	39.95	21.95
UTILITY CITY (DOS 3.3)	29.50	16.50

HOME/COMMUNICATION

	LIST	TRIAD
ASCII EXPRESS PRO (DOS, PRODOS)(EA)	\$129.95	\$77.95
DOLLARS & SENSE (64K +E)	100.00	59.95
DOLLARS & SENSE (128K E/C)	119.95	71.50
FAMILY ROOTS (QUINSEPT)	185.00	123.00
HAYES MICROMODEM 2E W/SC	199.00	140.00
MACH II JOYSTICK	44.95	27.95
PRINT SHOP	49.95	29.50
PRINT SHOP GRAPHICS LIB#1	24.95	15.95
RAMWORKS (256K)	299.00	230.00
TIMEMASTER II H.O.	129.00	102.00

RECREATION

	LIST	TRIAD
ARCHON II	\$ 40.00	\$ 26.95
BEAGLE BAG	29.50	16.95
CARRIERS AT WAR (NEW)	50.00	30.50
CHAMPIONSHIP LODGE RUNNER	34.95	21.95
DR. J & LARRY BIRD (1-on-1)	40.00	26.95
EXODUS: ULTIMA III	59.95	36.50
F-15 STRIKE EAGLE	34.95	21.95
FLIGHT SIMULATOR II	49.95	31.95
GHOSTBUSTERS	39.95	24.95
HITCHHIKERS TO THE GALAXY	39.95	24.50
I. O. SILVER (BEAGLE)	29.95	16.95
KING'S QUEST	49.95	30.50
KNIGHT OF DIAMONDS (WIZ 2)	34.95	21.50
LEGACY OF LYLLGAMYN (WIZ 3)	39.95	24.50
KARATEKA	34.95	21.95
MILLIONAIRE	49.95	30.50
MINER 2049'ER II	40.00	24.50
PINBALL CONSTRUCTION SET	40.00	26.95
PITSTOP II	40.00	25.50
RAILS WEST (SSI)	39.95	24.95
RENDEZVOUS WITH RAMA	39.95	24.95
SARGON III	49.95	30.95
SEVEN CITIES OF GOLD	40.00	26.95
SKYFOX	40.00	26.95
UNIVERSE	98.50	75.50
WILDERNESS (NEW)	50.00	30.50
WIZARDRY (PROVING GROUND)	49.95	30.50
ZAXXON	29.95	18.95

TERMS

PAYMENT: Checks/VISA/MC/MO/School P.O./COD.
Credit Card—Add 3% (Include #, Exp. Date, Tel #)
COD—Add \$2.50
School Purchase Orders—Add 1% (Min. \$1.50). School Terms: Net 30.
Personal Checks—Allow 10-14 Days for Processing Unless Guaranteed by Credit Card Number and Expiration Date.
Nebraska Residents—Add 3 1/2% Sales Tax.

SHIPPING: UPS Ground—\$2.00/Order. Others—Shpg. + \$3.00.

WARRANTY: Defect-free for 30 Days, Our Shipping Date.

RETURNS: Call 402-331-7312 for Return Number.

2000 ITEM DISKETTE CATALOG: \$5.00 (\$2.00 with Order).

FREE: Latest Flyer on Request. (Included with Order.)

*APPLE is a registered trademark of Apple Computer, Inc.
PREPARED JUN., 1985 PRICES SUBJECT TO CHANGE (#85-8)

TRIAD Software Products

1414 Cherry Tree Lane
Papillion, NE 68046

Orders Only: 1-800-835-7427, Ext. 310

Prices/Info>Returns: 1-402-331-7312

Daily: 8:30-5:30 CST/Saturday: 9:00-1:00 CST

CIRCLE 119 ON READER SERVICE CARD

Just A Few Reasons Why RAMWORKS™ Outsells ALL Other RAM Cards COMBINED

APPLEWORKS MEMORY Even though Ramworks enhances and expands a VAST ARRAY of other programs, Appleworks is our claim to fame. A 64K Ramworks will ADD 46K to your available desktop memory, a 128K Ramworks will ADD 91K, a 256K Ramworks will ADD 182K, a 512K Ramworks will ADD 364K and a 1 meg Ramworks will give you nearly an 800K desktop. And it's all done automatically! When you plug in more memory chips into your Ramworks card, Appleworks will find them—automatically. Ramworks also increases the maximum number of records from 1350 to 4300. And should you ever create a file larger than your disk capacity, Ramworks will automatically prompt you to insert more disks, so that any size file can be saved on regular floppies or a hard disk.

APPLEWORKS SPEED AND POWER Ramworks does more than just increase the desktop memory (as if that weren't enough). With Ramworks, Appleworks will be able to run up to 20 times faster. If you buy a 256K or larger Ramworks card, Appleworks will automatically load itself in Ramworks. This greatly increases the speed at which Appleworks operates by eliminating all that nasty, time consuming disk access on Drive 1. These are but a few reasons why we say that Ramworks is Appleworks' best friend.

EXPANDABILITY Ramworks was designed with the future in mind. As your needs increase, so can Ramworks. Clear instructions show you how to plug in more memory.

CO-PROCESSOR POWER A memory expansion connector on Ramworks will allow future co-processor cards to access the Ramworks memory, so you'll be able to take advantage of the new 16 and 32 bit microprocessors. This connector will also allow Ramworks to be expanded another 2 megabytes, so as memory technology improves, so will Ramworks.

SPEED Today, as programs become more and more sophisticated, they inevitably become larger. And many of today's best selling programs (like Appleworks) won't fit in a 128K Apple, so many of these new larger programs continually go back to disk in search of more data. With Ramworks, you can have enough memory so that the entire program will be loaded into Ramworks' memory. This greatly increases the speed of software because your disk runs at 300 RPM, but Ramworks operates at the speed of light!

COLOR The same slot that's used for memory expansion is also the slot that's used for RGB color display, so all those lesser memory cards of yesterday make you decide in advance if you want RGB color. Ramworks lets you decide later to add RGB color. For only \$129, an RGB option can be added to Ramworks to give you double high resolution color graphics and 80 column text. All with a razor sharp, vivid brilliance that's unsurpassed in the industry. The RGB option does not waste another valuable slot, but rather plugs into the back of Ramworks and attaches to any Apple compatible monitor. Remember, you can order the RGB option with your Ramworks or add it on at a later date.

COMPATIBILITY, OF THE SOFTWARE KIND Programs like Appleworks, Magic Office System, Flashcalc, The Spread Sheet, Diverse-A-Dos, Supercalc, Magicalc and many others automatically recognize all or most of Ramworks' memory (512K is average). The simple fact is that Ramworks is compatible with more off-the-shelf software than any other RAM card. Ramworks is 100% compatible with ALL software written for the Apple 80 column and extended 80 column card. Additionally, Ramworks can emulate other RAM cards so software written for other cards will run without modification. Software written for Ramworks will not work on other cards. We can emulate others, but others can't emulate us.

COMPATIBILITY, OF THE HARDWARE KIND Unlike others, Ramworks is fully compatible with hardware add on's from other companies, like the Sider and Profile hard disks. And Ramworks was designed in accordance with the official expansion rules defined by Apple so you don't have to worry about compatibility problems. As you continue to expand and make your Apple more powerful with other expansion products from Applied Engineering, you'll appreciate how each product has extra features designed to work with Ramworks and other products to give you a total performance package that is more powerful than the sum of its parts.

IT'S POPULAR Popularity translates into great software support because software companies can't support all RAM cards, they can only support the ones their customers are likely to own. And software companies appreciate the fact that when they write software for Ramworks in the IIe, they're also writing software for our memory expansion card for the IIc, Z-RAM. And our customer list reads like the Who's Who of Apple computing with just about every software company in the land buying one, including Apple Computer

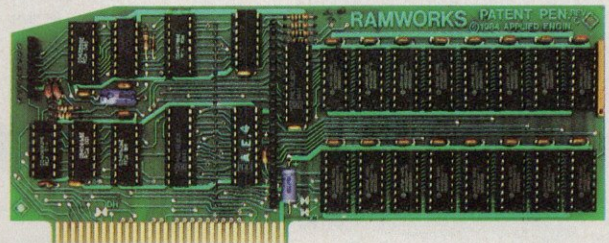

(in the hundreds), Rupert Lissner, and Steve Wozniak (we didn't give one to Mr. Wozniak just to use his name, 2 one meg Ramworks were paid for at full price).

IT'S FROM APPLIED ENGINEERING Unlike most of the competition, we only make accessories for Apple, so we'll never spend your money on IBM product research. Applied Engineering's years of experience and wide product line really pays off, and because of our high sales levels we buy most of our I.C. chips factory direct. So don't let our low prices fool you, they're caused by high volume production. That's why we can offer the most memory for the least money. Guaranteed!

IT'S GOT IT ALL

- Sharp 80 Column Text
- Double high resolution graphics (with or without RGB option)
- User Expandable to 1 Megabyte
- Can Use 64K or 256K RAMS in any combination
- Adds Memory to Appleworks
- Accelerates Appleworks
- 100% Compatibility with All IIe software
- RAM Disk software available, compatible with Applesoft, PRO-DOS, DOS 3.3 and PASCAL (\$29)
- RAM Disk available for CP/M (\$29). (This program is included with our CP/M card)
- Visicalc preboot available (\$29)
- RGB option
- Takes only one slot
- 3 year no hassle warranty

THE PATENT OFFICE HAS ONE There are many advanced features on Ramworks, but two parts of the design are so advanced we applied for patents. One patent application deals with our ultra fast, ultra smooth 80 column screen display, and the other patent application deals with our ingenious way of dramatically reducing the power and heat of memory chips and improving reliability at the same time.

HERE TODAY, HERE TOMORROW In the seven years we've been making products for the Apple, we've seen a lot of companies come and go. Although nothing is forever, we're growing, expanding and we're profitable. And we are totally committed to Apple computing, which means you'll never run out of things to do with Ramworks. Or for that matter, reasons to buy one.

Ramworks™ with 64K	\$179
Ramworks™ with 128K	\$249
Ramworks™ with 256K	\$299
Ramworks™ with 512K	\$399
Ramworks™ with 1 MEG	\$649
RGB Option (can be added later)	\$129

Call (214) 241-6060

9 a.m. to 11 p.m. 7 days a week or send check or money order to:
Applied Engineering, P. O. Box 798, Carrollton, Texas 75006

NOTICE: Not all sellers of Ramworks™ are authorized dealers. Please buy direct from Applied Engineering or an authorized dealer. If you wish to verify a dealer, please call us.



MasterCard Visa and
C.O.D. welcome. No extra charge for credit cards. Texas Residents add 5% sales tax. Add \$10.00 of outside U.S.A.

AE APPLIED ENGINEERING
"We Set the Standard"

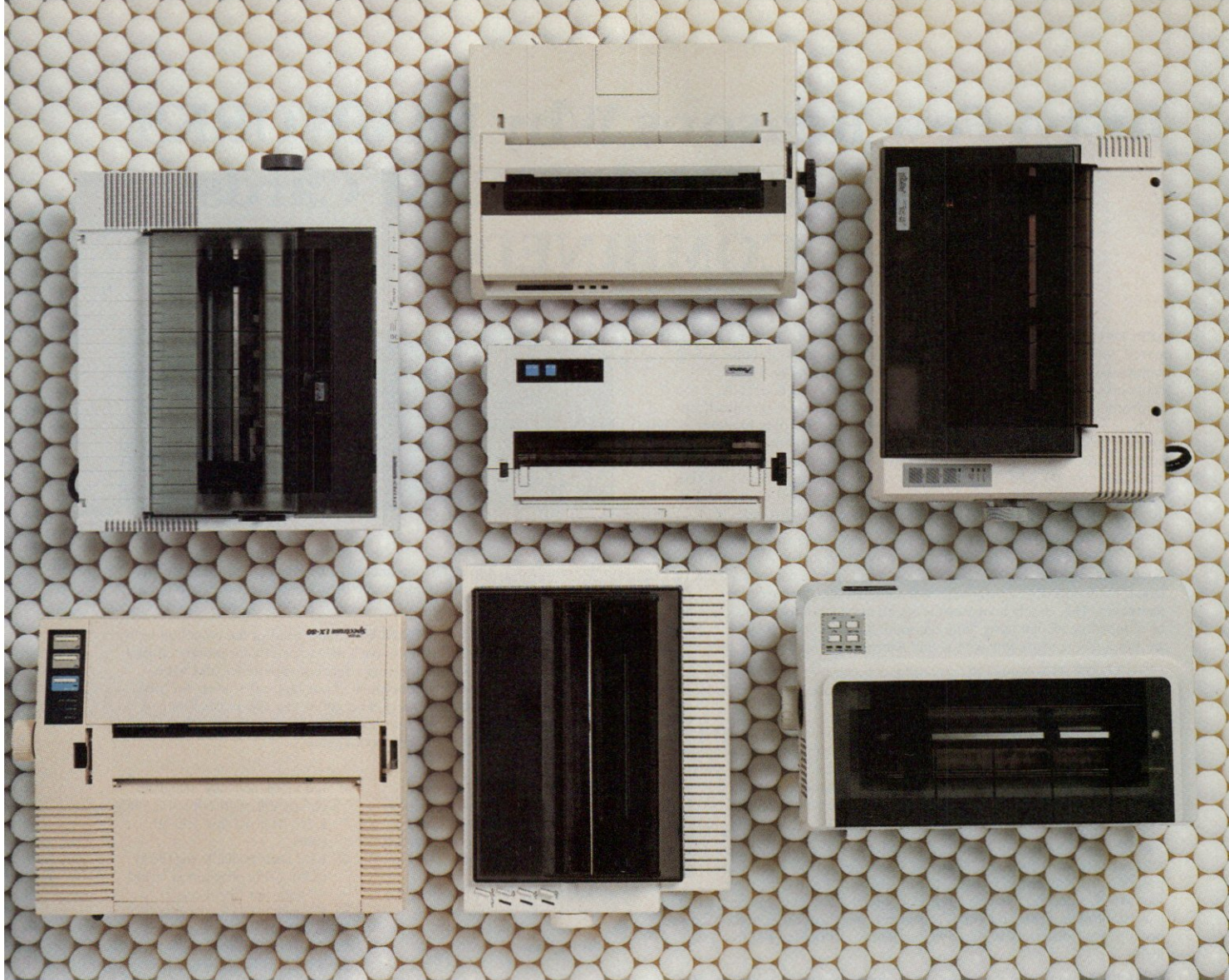

DOT-MATRIX

The computer printer is rapidly displacing the typewriter as the primary instrument for producing written communication. In 1984, computer printers printed an estimated 2.5 trillion pages, and this figure is expected to more than double by 1987. This article provides an overview of 15 popular dot-matrix printers. Although more than 200 different models of dot-matrix printers work with Apple computers, the printers we describe here will give you a pretty good idea of what dot-matrix printers can do.

If you can afford only one all-purpose printer for your Apple, it's a sure bet that you're in the market for a dot-

matrix printer. Computer users purchase more dot-matrix printers than any other type of printer. Their popularity stems from their low cost (starting at under \$300), their speed, and their flexibility in printing both graphics and text. Some models print only in black, and others print in color with a multicolored ribbon. This article will review a small sample of available dot-matrix printers—14 impact printers and 1 thermal-transfer printer.

What Makes the Dots?

Dot-matrix printers create characters and graphics by producing a series of dots laid out on a grid pattern. These dots are produced by one of three print-

ing methods: impact, thermal, or ink-jet. "Meet the Ink-Jets" in the July 1985 issue of *A+* (pages 48-59) contained an explanation of ink-jet technology and a review of several printers. See this month's "Applewords" column for some common dot-matrix terminology and further details on impact and thermal printing.

Impact printers are the noisiest of the dot-matrix printers because metal pins actually strike the ribbon, forcing it onto the paper. In contrast, thermal printheads do not strike the ribbon or paper. Therefore, thermal printers tend to be quieter than impact printers. Although thermal dot-matrix printers

APPLE IMAGEWRITER

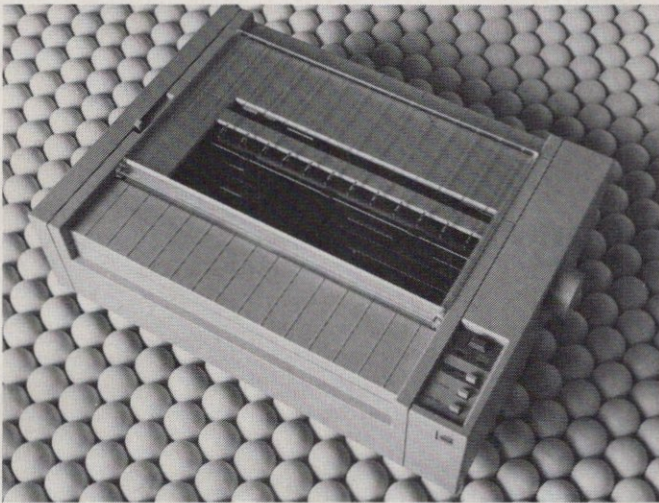

Standard A+ Magazine
Boldface A+ Magazine

APPLE SCRIBE

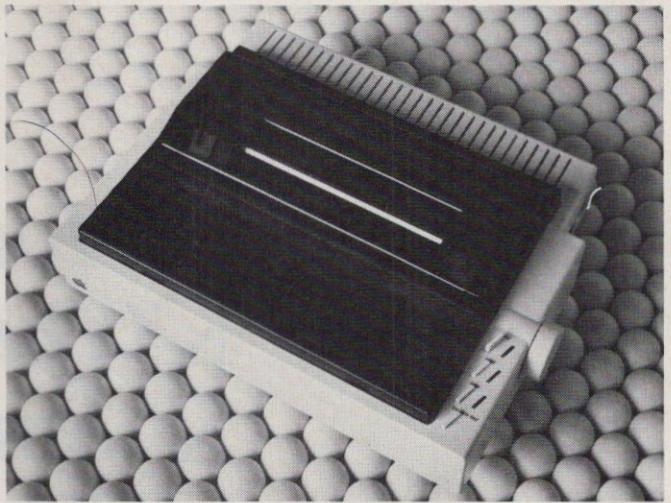

Draft Mode A+ Magazine
Letter Mode A+ Magazine

NLQ. This inconvenience may very well be a small trade-off for the nice print quality this truly quiet and portable printer produces.

Apple Imagewriter

The Imagewriter is Apple Computer's premier dot-matrix printer. Along with the basic features, the Imagewriter has a Headline mode for printing expanded characters in combination with any of the other six character pitches. Proportional spacing is usable with both pica and elite typesets, and underlining and emphasis can be added to all six print pitches. The normal

character matrix of 7×8 dots, which is not quite as dense as that of other printers, prints out at a mediocre 62 cps. Alas, the Imagewriter has no NLQ print. It does support the special features of the Macintosh, however. It also possesses memory for downloading 175 characters.

By using the Imagewriter Tool Kit disk that comes with the printer, for example, you can transfer special typefaces and typesets to the Imagewriter, which will allow you to print superscripts and subscripts or even design your own NLQ or graphics characters.

Apple Scribe

The Apple Scribe is an attractive thermal-transfer printer designed for the home market. It can print in black or in color by using a three-band color ribbon. The color ribbon comes with three primary colors (yellow, cyan, and magenta) and can combine to produce six colors plus black. Printing in color requires that the software you use is specifically suited for Scribe color printing. At this writing, about seven of these programs are available—Dazzle Draw from Brøderbund, The Write Choice, from Roger Wagner Publica-

EPSON FX-100+

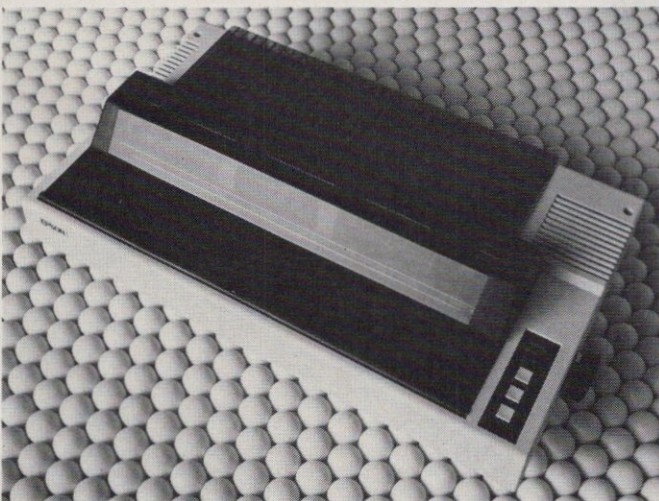

Draft A+ Magazine
Emphasized A+ Magazine

EPSON SPECTRUM LX-80

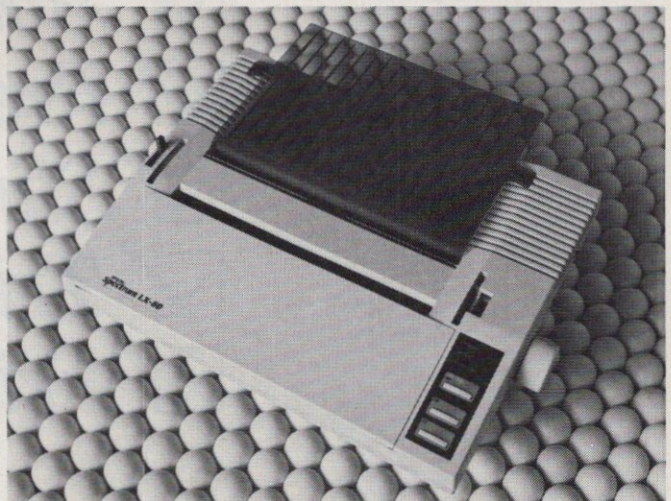

Draft A+ Magazine
NLQ A+ Magazine

- Tougher*
- Quieter*
- Smarter*
- Thriftier*
- Easier*
- Quicker*
- Finer*
- Cleaner*
- Sharper*
- Sturdier*
- Abler*
- Prettier*
- Slimmer*
- Trimmer*
- Friendlier*

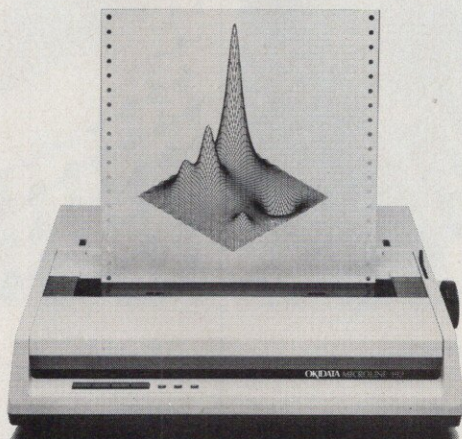

and smaller.

The new Okidata Microline 192 does everything the bigger, bulkier printers do. And more. But in a much smaller space.

It's easier to operate, too. With push-button menu select programming, so you never have to touch a DIP switch to set fonts, line widths, underlines and such.

It's compatible with your computer. Just plug it in and put it to work, without changing control codes. And, it's compatible with you. Long-life cartridge ribbons pop in and out without so much as smudging a finger.

Super-quiet operation and super-fast bidirectional throughput make the new Microline 192 one handy printer to own. All this, plus our full one-year warranty (try to find that on most printers), makes it the only one you should own.

The new Okidata 192 and the wide-column 193. Simply stated . . . better.

For more information, call toll free 1-800-OKIDATA.

OKIDATA
an OKI AMERICA company

Mt. Laurel, NJ 08054

We put business on paper.

CIRCLE 240 ON READER SERVICE CARD

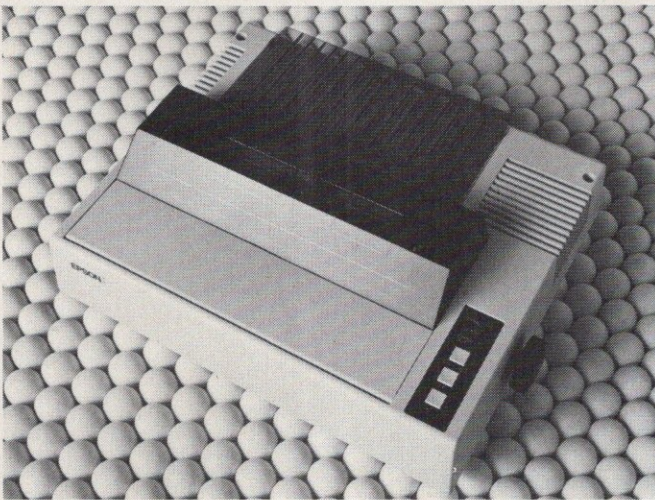
EPSON JX-80

Default A+ Magazine
 Emphasized A+ Magazine

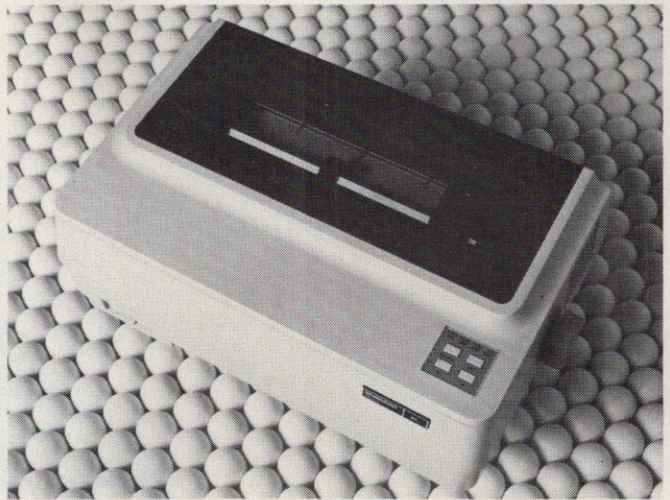
MANNESMANN TALLY MT85

Draft A+ Magazine
 NLQ A+ Magazine

tions; and KoalaPainter from Koala Technologies are three examples. Because the Scribe is a thermal-transfer printer, you will want to use smooth paper to get the best print quality. The Scribe comes with just three print styles: draft (the default), condensed, and NLQ. As with the Imagewriter, we found it a bit difficult to feed paper into the Scribe, and we also discovered that the printer wouldn't operate with the cover off. The biggest drawback of the Scribe printer may be its slow printing speed of only 33 cps in the Draft mode and 26 cps in the NLQ mode.

Citizen MSP-10

The Citizen MSP-10 is a new printer from Citizen America, a subsidiary of the well-known watch manufacturer. The Citizen printer we looked at has a clean, crisp print quality, especially in the NLQ mode. You can invoke the NLQ mode either through software commands or simply by pressing the line-feed and on-line buttons simultaneously.

The Citizen offers all the basic features and prints at a speed of 68 cps in the Draft mode and 23 cps in the NLQ mode. The documentation that we saw

was not in final form, but a note explained that the company would send a new version of it upon receipt of the registration card enclosed with the printer.

C. Itoh ProWriter M-1550/S

The C. Itoh ProWriter 1550/S is a wide (15.5 inches) printer that zips along at 90 cps and even offers an italic typestyle, beyond the basic features. The lack of an NLQ character set may be this printer's biggest drawback. The paper-out beeper, which sounds like a smoke-detector alarm, might also have been a drawback, except that you can

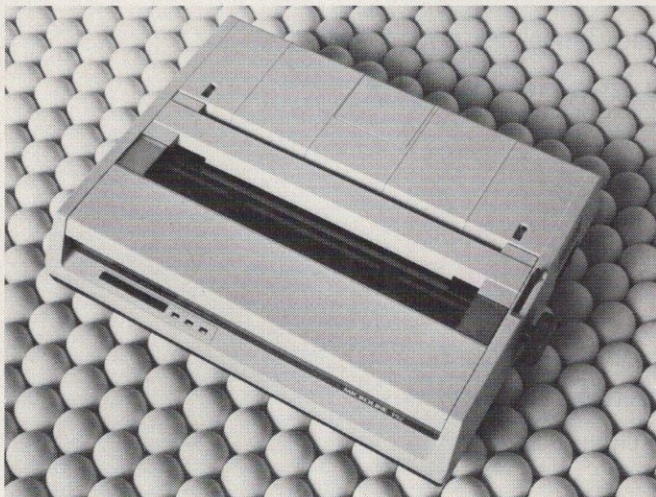
OKIDATA MICROLINE 192

Draft A+ Magazine
 NLQ A+ Magazine

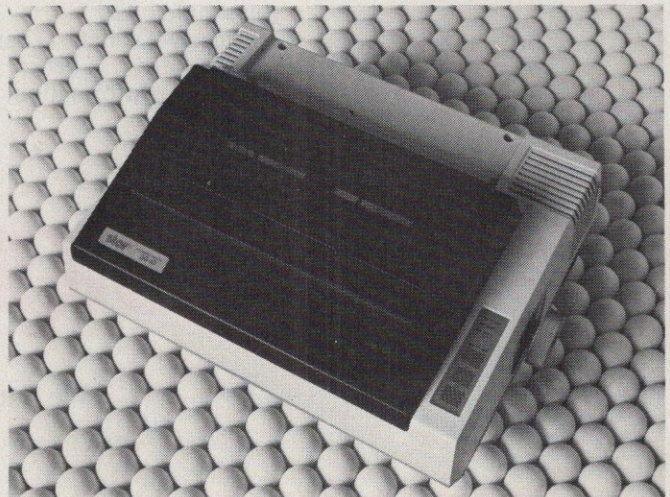
STAR MICRONICS, INC. SG-10

Draft A+ Magazine
 NLQ A+ Magazine

SMITH-CORONA D-200

Normal A+ Magazine

NLQ A+ Magazine

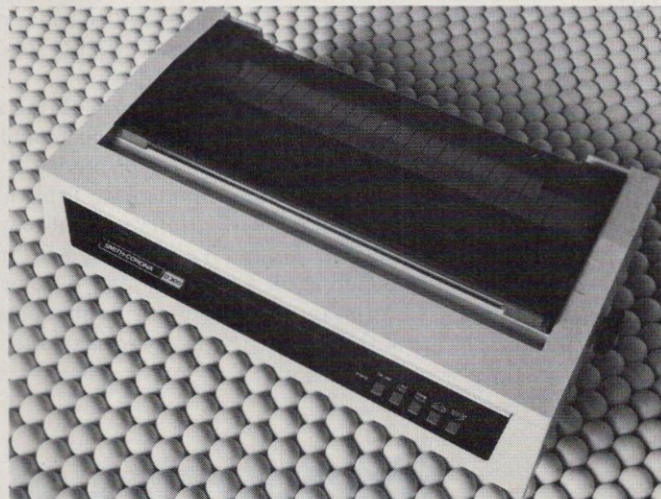
SMITH-CORONA D-300

Normal A+ Magazine

NLQ A+ Magazine

turn it off permanently if you like. There is, however, a 95-character download capability and 64 graphics characters to try out. Don't expect this printer to be quiet (it's fairly loud) or expect an easy-to-understand manual—it obviously was translated from Japanese.

Epson FX-100+, LX-80, and JX-80

Epson, a well-recognized name in printers, has several impact printers on the market. The three we review in this article have the basic features in addition to an italic typestyle and a Hex-Dump mode for programmers.

Unfortunately for Macintosh and Apple IIc owners, these Epson printers are available only with a parallel interface. You will need a serial-to-parallel converter to use these printers with a IIc or Mac. For owners of Apple II, II Plus, or IIe computers, Epson sells an Apple II Parallel Interface Kit for \$85.

On the positive side, the Epson printers include such distinctive features as SelecType and Master Select. The SelecType feature lets you choose typestyles (e.g., pica or elite) by using the three function buttons on the top of the printer. This feature is an easy-to-use departure from having to use control codes to change print modes. Speaking of control codes, the Master Select feature lets you enter any combination of eight different print enhancements or pitches by using a single ESC code sequence—a nice timesaver. Coupled with the Epson printers are clear, well-written manuals that make setting up and using these printers a breeze.

FX-100+. The FX-100+ is a longer-carriage version (holding paper up to 16 inches wide) of the popular FX-80+. One difference between them, however, is that the FX-80+ can print in the Immediate-Print mode (like a typewriter), but the FX-100+ cannot. A standard font (Roman, pica) comes with the FX-100+, but, with SelecType, you can choose combinations of ten typestyles including italic. The variety of print enhancements and pitch combinations is rather amazing, and the speed is a brisk 93 cps. The only enhancement that is lacking is an NLQ

print, but Epson has an optional board that will fix that and provide an additional 6K buffer.

Spectrum LX-80. A sleek new Epson printer is the LX-80. In addition to possessing the features found in other Epson printers, the LX-80 was the only Epson we tested that had both a Draft and NLQ print mode. In the Draft mode, it prints letters in any one of four available print sizes and eight print enhancements. The SelecType on the LX-80 features about half as many choices as on the FX-100+, but it includes NLQ print. Not surprisingly, when we

CONNECTING APPLES TO PRINTERS

Apples use two main methods for communicating with printers, a serial connection or a parallel connection. Parallel printers usually come equipped with a Centronics-type parallel communications port and serial printers are usually equipped with an RS-232 serial communications port. You'll need to make sure you have the right interface and cable before you can hook your printer up to your computer. Here's a brief run-down on what you'll need to connect your Apple to a printer.

Computer	Serial Printers	Parallel Printers
Apple II, II Plus, IIe	RS-232 serial interface card and cable	Centronics-type parallel interface card and cable
Apple IIc	IIc serial cable	Serial-to-parallel converter and IIc cable
Apple III	RS-232 serial cable	Serial-to-parallel converter and cable
Macintosh	Mac serial cable	Serial-to-parallel converter and cable
Lisa (Mac XL)	RS-232 serial cable	Serial-to-parallel converter and cable

switched from the Draft mode to the NLQ mode, the print speed we measured dropped significantly, from 68 cps down to 15 cps.

JX-80. The JX-80 is a color impact printer, similar to the FX-80+. In fact, it offers all ten of the SelecType functions of the FX-80+ and FX-100+. The easy-to-install ribbon cartridge contains three primary colors (yellow, cyan, and magenta) plus black. These three primary colors can combine for a total of seven colors. In addition, you can print various shades of these colors,

such as adding magenta to orange to produce a deeper, redder orange color. The control codes necessary to produce these various shades are straightforward.

Along with the various print pitches and enhancements available on other Epson printers, the Epson JX-80 has an Immediate-Print mode that allows the printer to print text as you type it on the keyboard (good for typing single envelopes). For a color printer, the 83-cps default print speed we observed was pretty respectable.

Mannesmann Tally MT85 and MT86

The attractive casing of the new MT85 and MT86 printers contain a wealth of features not to be missed. Actually, the MT85 and MT86 printers are identical, except for the carriage widths of 8 and 13.5 inches, respectively. One of the unusual features of these two printers is the programmable front-panel DIP switches. Although you may never change most of these switches (such as those that can control how the printer communicates to your Apple, for example), other options exist (such as NLQ vs. Draft mode, or paper-out beeper on vs. off) that you certainly would want to use on occasion. The MT85 and MT86 can print out the switch settings for you, helping you change them easily without the need of a flashlight and screwdriver to get at the DIP switches.

Other features the MT85 and MT86 possess include plug-in font-generator modules at \$34.95 each for new character sets. Even without these extras, the printer still has an italic character set, memory for 256 download characters, and the usual variety of print pitches and enhancements. What's more, an NLQ mode can be combined with proportional spacing and any one of four print pitches. We ran our speed test on the MT85 in the Draft mode and saw 99 characters per second fly by, while the NLQ mode sauntered through at 27 cps. Surprisingly, the printer was among the quieter ones we heard. To top it off, the manual was one of the most readable and supportive.

Okidata Microline 192

The Microline 192 is a full-featured printer with several features that make it easier to use. For instance, the Microline 192 does a better-than-average job of detecting the end of the paper, because its paper sensor is on the left side of the platen bar near the level of the printhead, rather than behind the platen bar as is the case with many other printers. In addition, paper feeds in either from the top of the printer, as is the case with most printers, or from beneath, which is especially handy for continuous sheets.

The Microline 192 prints at a speed of 31 cps in the NLQ mode and 90 cps in the Draft mode. Perhaps one of the most helpful features of the Okidata printer is its excellent documentation. The manual is not only comprehensive, but also reasonably easy to understand.

Smith-Corona D-200 and D-300

This familiar typewriter manufacturer offers several dot-matrix printers

Megabytes of Appleworks Power with the MultiRam //e Card™

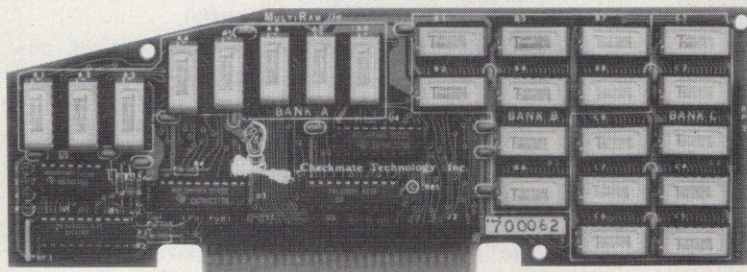

- ★ Expands the //e from 64 K to 1.5 megabytes
- ★ Expandable using 64K or 256K chips to 768K per card
- ★ AppleWorks memory patch included with each card to expand desktop space up to 1 megabyte
- ★ DOS and ProDOS disk emulators included at no charge
- ★ Built-in 16 bit microprocessor CPU port
- ★ Optional ¾ MEG and RGB up-grade expansion card
- ★ 100% replacement for the extended 80-column card
- ★ Provides 80-columns and LED memory bank display
- ★ Single chip replacement for future memory protocols
- ★ 100% compatible with double hi-res graphics
- ★ All ICs are socketed
- ★ Made in the U.S.A.

Retails from \$159.95 with 64K

Now available from your favorite local dealer.



Checkmate Technology, Inc.

509 South Rockford Drive • Tempe, Arizona 85281-3021
(602) 966-5802 U.S.A.
(800) 325-7347 Telex: 165-025 CEC PHX

ALL PRODUCTS MADE IN THE U.S.A. — EXCLUSIVE 5 YEAR WARRANTY

CIRCLE 128 ON READER SERVICE CARD

worth noting. The D-200 and D-300 are two printers with the same internal mechanism and features but different carriage widths (11 and 14 inches, respectively). In addition to the basic features, they have italics, a Hex-Dump mode, two graphics character sets, and even memory for 96 download characters. The NLQ font should handle your correspondence needs, and it can be combined with elongated or proportional spacing. The skimpy manual might lead one to believe that there is little to be said for this printer, but this is certainly not the case. In fact, the speed of the D-200 and D-300, at 97 cps, was among the best we saw for the Draft mode, although this speed dropped down to about 22 cps for NLQ.

Star Micronics SG-10

For a flexible, multifeature printer with a convenient, easy-to-understand manual, take a look at the Star Micronics SG-10. You can print in the Draft or NLQ modes, or even in italic characters. Not only does the SG-10 have all the basic features, but many combinations of them are also allowed. Surprisingly, the NLQ mode seems to be the one mode that does not mix with proportional spacing. With its full set of graphics characters and some 240 additional characters that you can download, however, this printer is hard to find fault with. This printer's worst feature has got to be the spool-feed (non-cartridge) ribbon that adds time, and dirty fingers, to the setup procedure. Its best feature is certainly its easygoing manual. The Star SG-10 manual, unlike most manuals, makes reading about the printer practically entertaining. Besides the ribbon, the only other nuisance we found was the piercing paper-out beeper that made us run for cover. This beeper, fortunately, can be turned off. The print speed we measured was 82 cps for the Draft mode and 20 cps for NLQ.

Which Is Best?

Unless you're confident that you know what you're doing, don't buy a printer until you have someone (such as a dealer) demonstrate that it works with your computer and your software. Remember to determine what other items (interface cards, cables, and so on) you'll need in order to get the printer running. Then you'll be better able to compare prices.

As always, the final choice is a matter of considering your needs and your budget. A graphic artist is likely to be more interested in color-printing capabilities than in NLQ print and fancy

The SmartChipTM For SMART Apple II Owners

MULTITASKING & VIRTUAL MEMORY

RUN 2, 3, OR MORE PROGRAMS SIMULTANEOUSLY!

Millions of pages of virtual memory! On tap — 2000+ characters on 170,000+ items! Search and sort — store and recall.

■ **INCLUDES: MEGA CALC SPREADSHEET** — Copy formulas, data, etc. Formats independently. Adds screens and files to your spreadsheet!

■ **MEGA STAR.** Can set any margins or tabs without reformatting! Double-wide characters and proportional spacing allow design of reports and letters. Easy as a typewriter!

■ **MEGA BASE.** Menu driven. Multiple search. Add and expand your data base - easily! No guesswork!

REQ: Apple® II/II+ - 16 KB Card, Applesoft, or 3 ROM Chips, 1 Disk Drive (2 for Mega Base), Apple® IIe requires no additional equipment. Works with The Sider 10 MB Hard Disk.



Quantum Leap Technologies Corporation
One Corporate Center
P.O. Box 6440
Arlington, Virginia 22206
(703) 998-7770

INTRODUCTORY OFFER
PRICE ONLY \$495 - Thirty (30) Day Trial Guaranteed - Add \$4.95 Shipping, USA

NAME _____
ADDRESS _____ STATE _____
CITY _____ PHONE _____
ZIP _____

Business and/or Personal Checks. ORDER NOW!

CIRCLE 220 ON READER SERVICE CARD

GIVE YOUR PRINTER A FACELIFT.TM



FACELIFT works with your APPLE II, IIe and II+ to set as many as 92 type faces, sizes and styles on the EPSON MX (with GRAFTRAX), RX and FX Printers, and their compatibles (like Star, Okidata and Smith Corona). 416 different faces, sizes and styles on the EPSON LQ-1500.

There's nothing to learn. Just call up the menu, push a typing key, and the printer is set to the face you've chosen.

From Word Processing to Spreadsheets, FACELIFT[®] will give you lots of the things you bought your printer for.

GET YOUR PRINTER'S WORTH.

Please Send Me a FACELIFT!

Here's my \$29.95 Plus \$2.50 POSTAGE & HANDLING (\$32.45 TOTAL)

(California Residents add 6.5% Sales Tax)

PHONE ORDERS (213) 696-8739

MasterCard
 Visa
 Check, M.O.
(Make payable to Companion Software, Inc.)

Name _____

Address _____ Tel () _____

City _____ State _____ Zip _____

Signature _____ Date _____

Acct # _____ M.C. Interbank # _____ Exp. Date _____

Specify Computer Make and Model _____

FACELIFT, P.O. BOX 4339, WHITTIER, CA 90607

A+

CIRCLE 303 ON READER SERVICE CARD

HOW TO TURN YOUR APPLE® INTO A BANKER.

Here's how to make the investment in your Apple really pay off.

With SPECTRUM,™ the new electronic home banking and information system from The Chase Manhattan Bank, N.A. Teamed up with your PC, SPECTRUM is your direct link to Chase. And the start of a better way to manage your money and your time.

A push of a button lets you pay bills electronically, anywhere; transfer funds; keep records, and more. Even get vital financial information and trade stocks* at discount rates.

Right at home, anytime—with complete security. All, including electronic mail, starting at just \$5 a month. And with our new subscriber rebates and free offers, now's an even better time to get control of your finances. Call today for your free demo diskette.

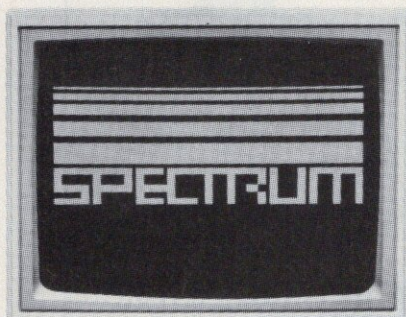

**CALL TOLL FREE
1-800-522-7766**



© 1985 The Chase Manhattan Corporation.
Apple is a registered trademark of Apple Computer, Inc.
*Stocks are traded through Rose & Company,
a Chase affiliate.

CIRCLE 179 ON READER SERVICE CARD

text features. A writer will probably consider the text features of paramount importance, but a programmer who's on the go might look for portability, speed, or Hex-Dump modes. For everyone, noise and price are strong considerations, but attention to usable trade-offs can help you choose the right printer for your particular situation. + We'd like to thank Western Micro Systems of Cupertino, California, and

Stanford Computer Basics of Mountain View, California, for providing some of the equipment reviewed in this article.

Francesca Venning-Townsley, a writer/instructional designer, has written about computer products since 1982. David Townsley is a product engineer in the semiconductor industry and a frequent contributor to A+.

▶ PRODUCT INFORMATION

Aero Printer

Alphacom, Inc.
2323 South Bascom Avenue
Campbell, CA 95008
(408) 559-8000

List Price: \$249.95

Requires: Apple II, II Plus, IIe, IIc, or III

CIRCLE 396 ON READER SERVICE CARD

Citizen MSP-10

Citizen America Corp.
2425 Colorado Avenue
Santa Monica, CA 90404
(213) 453-0614

List Price: \$449

Requires: Apple II Plus, IIe, or IIc

CIRCLE 397 ON READER SERVICE CARD

D-200, D-300

Smith-Corona
3695 Erie Blvd., East
DeWitt, NY 13214
(800) 448-1018

List Price: D-200, \$549; D-300, \$745

Requires: Apple II, II Plus, IIe, IIc, or III

CIRCLE 398 ON READER SERVICE CARD

FX-100+, Spectrum LX-80, JX-80

Epson America, Inc.
2780 Lomita Blvd.
Torrance, CA 90505
(213) 539-9140

List Price: FX100+, \$699; Spectrum LX-80, \$299; JX-80, \$699

Requires: Apple II, II Plus, IIe, or III

CIRCLE 399 ON READER SERVICE CARD

Imagewriter

Apple Computer, Inc.
20525 Mariani Avenue
Cupertino, CA 95014
(408) 996-1010

List Price: \$595

Requires: Apple II, II Plus, IIe, IIc, III, Macintosh, or Mac XL

CIRCLE 400 ON READER SERVICE CARD

Microline 192

Okidata
532 Fellowship Road
Mt. Laurel, NJ 08054

(609) 235-2600

List Price: \$529

Requires: Apple II Plus, IIe, or IIc

CIRCLE 401 ON READER SERVICE CARD

MT85, MT86

Mannesmann Tally
8301 South 180th Street
Kent, WA 98032
(800) 447-4700

List Price: MT85, \$499; MT86, \$599

Requires: Apple II, II Plus, IIe, IIc, III, Macintosh, or Mac XL

CIRCLE 402 ON READER SERVICE CARD

ProWriter M-1550/S

C. Itoh Digital Products
1011 Francisco Street
Torrance, CA 90502
(213) 327-5939

List Price: \$849

Requires: Apple II, II Plus, IIe, IIc, or III

CIRCLE 403 ON READER SERVICE CARD

Scribe

Apple Computer, Inc.
20525 Mariani Avenue
Cupertino, CA 95014
(408) 996-1010

List Price: \$299

Requires: Apple II, II Plus, IIe, or IIc

CIRCLE 404 ON READER SERVICE CARD

SG-10

Star Micronics, Inc.
200 Park Avenue
Suite 2309
New York, NY 10166
(212) 986-6770

List Price: \$299

Requires: Apple II, II Plus, IIe, IIc, or III

CIRCLE 405 ON READER SERVICE CARD

ThinWrite 80

Axonix Corporation
417 Wakara Way
Salt Lake City, UT 84108
(801) 582-9271

List Price: \$449

Requires: Apple II, II Plus, IIe, IIc, or III

CIRCLE 406 ON READER SERVICE CARD

The 10 MB Sider™ gives you something no \$1000 hard disk gives you...

\$300 back.

The Sider is also available for the Apple Macintosh at even greater savings—call for details.

No question about it, you can get a reliable "big name" 10 megabyte hard disk for your Apple II+ or IIe. Trouble is, you're likely to spend a small fortune for it. Because you're not just paying for the subsystem. You're also footing the bill for some hefty distribution costs, retail overhead...and the dealer's profit margin.

Happily, you now have an alternative: the 10 megabyte Sider from First Class Peripherals. This rugged, dependable hard disk offers the speed, convenience and storage capacity to meet your computing needs. But more importantly, it's sold *direct to you* for only \$695—complete.

State-of-the-art technology at a state-of-the-art price

The Sider features field-proven Winchester disk technology. Direct booting without floppies. Self-contained power supply. And compatibility with all the most popular Apple software.

What's more, the Sider is *plug and play*. You get everything you need for quick, easy installation: cables, host adapter card, software and manual.

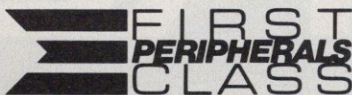

3579 Highway 50 East, Carson City, NV 89701

Built to last by Xebec

There's good reason for the Sider's top performance and outstanding reliability. It's designed and built exclusively for First Class Peripherals by Xebec, the industry's leading manufacturer of disk drives and controllers...and supplier to giants like IBM, Texas Instruments and HP.

Full guarantee, free Tech Hot-line

Our reassuring, money-back guarantee lets you order the Sider with confidence. Simply use it for 15 days. Then if you're not 100% satisfied, return it for a full refund. Keep the

Sider and enjoy a full one-year limited warranty...plus access to our toll-free technical/service hotline.

Get your Sider—Only \$695

Enjoy the quality and performance of a \$1000 hard disk—and save over \$300—when you order the Sider. Simply use the coupon below. Or for faster service, order by telephone using VISA, MasterCard or American Express. Call toll-free:

1 800 538-1307

Extension 224

Yes, please send me the Sider, including 10 megabyte Winchester hard disk drive, host adapter card, cable, complete installation software and documentation.

I prefer to pay as follows:

- I've enclosed my check or money order for \$695* + \$15 shipping and handling, payable to First Class Peripherals.
- Please bill the following credit card account for \$695* + \$15 shipping and handling:
- VISA MasterCard American Express

Card # _____ Exp. Date _____

Signature _____

*Residents of CA, NV and PA, please add appropriate sales tax.

Name _____

Address _____

City _____

State _____ Zip _____

Telephone (area code) _____

Mail to: First Class Peripherals
3579 Highway 50 East, Carson City, NV 89701

SUMMER IS HERE,
and the mode
in *haut tech*
is *leisure*.
Time to
pack
away those
heavy spread-
sheets and
forecasting
packages;
time to put
those complex
integrated
packages on the
shelf for while.
Summer is the
time for fun
and fashion.



LEISURE

The word among the software-fashion-conscious this season is *leisureware*. And when it comes to leisureware, designers seem to have something for just about every Apple II user.

NATIONAL PASTIME

What's synonymous with summer? Baseball, of course, and this summer baseball is as American as Apple II. For the Apple, from Rainbow Computing of Northridge, California, comes Bat-Stat, a baseball-statistics package. If you enjoy keeping track of every movement of your preferred players, this software can keep you company during your favorite summer activity.

SPORTSWARE

People of summer leisure do not live by baseball alone. When it comes to sportsware, several other designers have packages for your consideration.

If you golfers don't want to get out there and tread the links, you can simulate a game on some of the world's top courses with Golf's Best from ISTEP Software, Inc., of Charlotte, North Carolina. This golf-simulation program features color graphics, close-ups, aerial views, and scorecards.

Horse-racing fans: A package from PDS Sports of Torrance, California, is designed for handicapping races and deciding which horses to play. The package is called Thoroughbred Handicapping System I.

Another California designer, Market Computing of Huntington Beach,

has a full line of sportsware. This company is big in the leagues. League Registration, League Scheduling, and League Standings are all aimed at maintaining the various activities and needs of sports leagues.

Swim Meet and Tennis Draw keep track, respectively, of swimming and tennis contests.

With the emergence of the USFL, football has become a virtual year-round sport. The Predictor from Pickham Software purports to help you pick winners in football bouts.

As the NFL exhibition season starts, you can start to handicap the games with NFL Football, Gold Edition, from Systems Design Lab of Redondo Beach, California.

Runners and would-be runners are the targets of Software Publishing Corporation (Mountain View, California) with The Running Coach. After you have selected your running ensemble, use this package to develop your own running program (an upcoming issue of *A+* will review The Running Coach and other running programs).

NUMBERSWARE

If your concept of leisure involves numbers, you can enter lotteries. Matrix Software of Big Rapids, Michigan, produces a program, Lucky Day/Lottery Report, with which you can create and maintain reports on the numbers game Lotto. Veteran Lotto players will no doubt find this program useful. Lottery tyros, however, may be taking a gam-

ble, since skimpy documentation provides virtually no information about how to play the game.

WEARWARE

Leisureware isn't restricted to sportsware and numbersware. From Compucrafts of Lincoln, Massachusetts, comes Stitch Grapher, a computer-aided-design package. Computer couturiers can use the package for needlepoint, bargello, latch-hook, and design knitting. By selecting from a group of 30 symbols, you create a design on a grid, making corrections as you progress. You can store your results and print them for later use.

WHERE?WARE

Whether or not we are all descended from Adam and Eve—no strangers to the Apple—we all have roots somewhere. Now you can use your Apple to help you trace your origins. Ancestry Link from Accelerated Logic, Inc., is a genealogical-research program. It is aimed at genealogical professionals and family historians. Since it can catalog and track 1000 ancestors and descendants, it requires four disks: tutorial, program, auxiliary, and data.

WETWARE

Summer is the time for nice cool gin and tonics, mint juleps, and other refreshments. If you're new to the art of mixology or if you've forgotten how to assemble your favorite concoction, the Mr. Boston Official Bartender Guide is

WARE

SUMMER
SOFTWARE
FUN
FOR
APPLE II
USERS

BECKER BISHOP PHOTOGRAPHY BACKDROP: MGI STUDIOS, SAN FRANCISCO

TURN YOUR APPLE INTO A FULL-TIME PARTNER

Let's Talk™ a revolutionary new telecommunications program that operates your Apple unattended as a sophisticated answering machine and information server.

With **Let's Talk™**, your computer has the power to operate your own micro version of Dialog or Compuserve. Services that formally required a mainframe can now be offered on a smaller scale with an Apple computer from your home, office, or school. And you decide what goes on-line.

Let's Talk™ is the electronic link that puts your information on-line. Now your computer can advertise and support products and services, list catalogues, and accept orders while providing electronic mail, and information to callers any time, day or night. And all they need to get your message, or send you one, is any computer and a modem.

What's more, callers can upload and download files or create them easily and quickly because **Let's Talk™** doesn't require any complex commands to operate. Press a designated key and a file opens. You can also protect selected files or the entire system with a built-in password option.

So get yourself the most sophisticated program available for electronic information exchange.

Order **Let's Talk™** for \$125.00 from **RUSS Systems** 320 Dufour Santa Cruz, Ca 95060 408/427-1540(voice) or have your computer call for a demonstration 408/427-0310(data). 24 hour customer support available

The only equipment you need is an Apple III, 256k, or IIc or IIe 128k, a 2nd disk drive - floppy or hard and an Auto Answer Modem.

Let's Talk™ DATABOARDS REACH MILLIONS

Easier to use than an on-line DATA baseMore professional than a bulletin BOARD.

now in software form, from Concept Development Associates, Inc. This libationary leisureware provides you with more than 100 recipes, which you can catalog, print out, or edit to suit your taste. The next time you have a pool party, haul your Apple out to the patio and set it up on the bar. Just be careful not to spill any of your creations on the keyboard or the three disks: program, liquor drinks, and liqueur drinks. Before you have too many cocktails, make yourself a data disk.

MINDWARE

What makes you tick? Personality Profile from Psychological Psoftware of Del Mar, California, won't give you any real insights, but you might find it entertaining. It's similar to Mind Prober from Human Edge Software; the difference is that Mind Prober allegedly psychs out other people. Like a horoscope, Personality Profile provides all-purpose "insights" into your life—example: "You have great ego strength." You answer some multiple-choice questions, and onto the screen pops an interpretation of your answers.

Also from Psychological Psoftware comes a package with which you can analyze and log your dreams, The Dream Machine.

Biofeedback falls under the category of mindware, and Synapse Software of Richmond, California, has a package called Relax. Are you really relaxed on those lazy summer days? Use your Apple to monitor your circadian rhythms.

TRAVELWARE

Summertime is vacation time—time to get out and see the world. Micro Travel Companion from Concept Development Associates, Inc., of Bethesda, Maryland, is an electronic Baedeker for travelers. If you're planning to take a trip this summer, you can use this package to plan the itinerary and keep a database of reservations, favorite locations, and other travel-related information. (From the same manufacturer: Wine Companion and Kitchen Companion.)

More adventurous travelers may want to fly their own planes to destinations near and far. Pilot Log from DHM Specialty Software of Dallas, Texas, gives pilots the option of keeping their logbook on an Apple.

While your mind is on the skies, you may want to experiment with a package called Computer Assisted Astrol-

ogy, from Matrix Software.

SAVINGFACEWARE

Facial fashion is the specialty of Mask Parade from Springboard Software, Inc., of Minneapolis, Minnesota. Designed for kids, the package lets them create their own masks, print them out, and wear them. Mask Parade gives little designers the option of assembling masks from stock elements or making their own from scratch with a built-in "crayon." This program is similar in concept and operation to Springboard's The Newsroom, with which you can create rudimentary newsletters (see review in *A+* next month).

Also for creative kids is Many Ways to Say I Love You from CBS Software of Greenwich, Connecticut. They can use the package to create their own electronic greeting cards.

GARDENWARE

With Plantin' Pal from Home & Hobby Software, Inc., of Minneapolis, Minnesota, you can make your garden fashionable, as well as plan your planting. The package can plan a 60 × 36-foot patch. You decide what and how much you want to plant. The program fills the garden grid with symbols for your crops. If you run out of space, you alter quantities or delete certain crops. The program and manual also provide comprehensive data on individual crops, companion crops, garden pests, and other gardening considerations.

POSTALWARE

Stamp collecting, which is heavily dependent on cataloging, seems to be an ideal match for an Apple. Andent, Inc., of Waukegan, Illinois, has made the match with a six-program database for philatelists called Stamp Collector.

Mention leisureware, and a lot of people still think of games. As the foregoing survey indicates, your leisureware collection doesn't have to be limited to shoot-'em-ups and convoluted role-playing scenarios. *Eclectic* is the word in software this summer.

Some of the leisureware in this survey amounts to little more than games, but some of it is useful tools that can also be informative and entertaining.

Have fun. **+**

John Barry, a free-lance writer and editor, is coauthor of The Unofficial I Hate Computers Book. He is a funware expert par excellence.

THE SHOCKING TRUTH ABOUT STATIC ELECTRICITY AND YOUR COMPUTER.

FACT : MANY COMPUTER MALFUNCTIONS ARE RELATED TO STATIC ELECTRICITY.

Static electricity is an invisible enemy that can be caused by normal everyday activities. Like walking across a carpet. Picking up a Styrofoam™ cup. Or just crossing your legs. These actions can generate a static charge of up to 30,000 volts, while it takes only a few hundred volts to damage your computer's microchip. Even you wouldn't feel the charge until it reached over 5,000 volts.

HOW STATIC ELECTRICITY CAN ZAP YOUR COMPUTER.

Static charge can cause glitches and blips. Lost data. Memory loss. Or even permanent chip damage that may not be determined until months later. The result could mean expensive downtime and unnecessary aggravation. In the past, these problems have been blamed on equipment malfunction or operator error when the real culprit was static electricity.

INTRODUCING STATIC-MASTER™ MATS BY FORMICA CORPORATION.

Anti-static laminate mats offer a durable, dependable, solid laminate solution to static electricity. STATIC-MASTER mats are 1/8" thick with the anti-static properties built right in. They won't bend, tear or curl, and can be easily cleaned. The edges are rounded for a safe, handsome and finished look. They're also ideal for just about all electronic equipment.

Just connect the ground cord and touch the mat before you touch your equipment. All static electricity will be instantly and safely dissipated. Neither you nor your equipment will feel any shock.

So get STATIC-MASTER anti-static laminate mats now. And zap static electricity before it zaps your computer.



Call toll free 1-800-367-6628

FORMICA CORPORATION OFFERS A LIFETIME GUARANTEE WITH EVERY STATIC MASTER MAT.

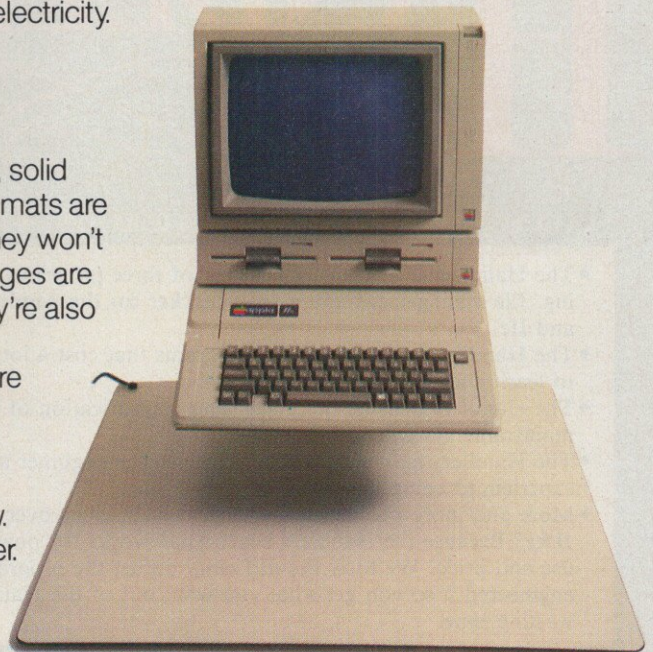
DEALER INQUIRIES ACCEPTED.

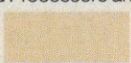
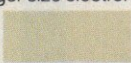

* Trademark Formica Corporation Apple is a registered trademark of Apple Computer Inc.

Sizes	Almond	Gray	Lt. Oak	Walnut	Prices	Total
18" x 20" Ideal for Apple and other small PC's	_____ S101	_____ S102	_____ S103	_____ S104	\$49.95	_____
26" x 26" Ideal for IBM PC's, Word Processors and larger size electronic equipment	_____ S201	_____ S202	_____ S203	_____ S204	\$79.95	_____
					Add applicable Tax _____ CA, FL, GA, HI, IL, IN, MD, MA, MI, MO, NJ, NC, OH, PA, TN, TX	Shipping & Handling \$3.50
Ship To: Please Print	Check one					Total _____
Name _____	Visa <input type="checkbox"/>					
Company _____	Master Card <input type="checkbox"/>			Card # _____		
Address _____	American Express <input type="checkbox"/>			Card Holder _____		
City, State _____ Zip _____	Expiration Date _____			Signature _____		
Please allow 4 weeks for shipment.						
Make checks payable to: Formica Corporation						
Mail to: Formica Corporation Static-Master Dept. A 10155 Reading Road Cincinnati, OH 45241						

Static Master™

Static Control Products—by Formica Corporation

▶ PRODUCT INFORMATION

Ancestry Link

Accelerated Logic, Inc.
108 East 38th Street
Suite 902
New York, NY 10016
(212) 683-7127

List Price: \$99.50

Requires: Apple II Plus, IIe, IIc, or III;
48K RAM; one disk drive; DOS 3.3

CIRCLE 380 ON READER SERVICE CARD

Golf's Best

1STEP Software, Inc.

Charlotte Plaza
Suite 1300
Charlotte, NC 28244
(800) 525-GOLF

List Price: \$49.95

Requires: Apple II, II Plus, IIe, or IIc
CIRCLE 381 ON READER SERVICE CARD

Lucky Day/Lottery Report

Matrix Software
315 Marion Avenue
Big Rapids, MI 49307
(616) 796-2483

List Price: \$300

Requires: Apple II, II Plus, IIe, or IIc;
48K RAM; one disk drive

CIRCLE 382 ON READER SERVICE CARD

Many Ways to Say I Love You

CBS Software
One Fawcett Place
Greenwich, CT 06836
(203) 622-2500

List Price: \$29.95

Requires: Apple II Plus, IIe, or IIc; 48K
RAM; one disk drive

CIRCLE 383 ON READER SERVICE CARD

Mask Parade

Springboard Software, Inc.
7807 CreekrIDGE Circle
Minneapolis, MN 55435
(612) 944-3912

List Price: \$39.95

Requires: Apple II Plus, IIe, or IIc; 48K
RAM; one disk drive; printer

CIRCLE 384 ON READER SERVICE CARD

Micro Travel Companion

Concept Development Associates,
Inc.
7960 Old Georgetown Road
Suite 2D
Bethesda, MD 20814
(301) 951-0997

List Price: \$49.95

Requires: Apple II Plus, IIe, or IIc; 48K
RAM; one disk drive

CIRCLE 385 ON READER SERVICE CARD

Mr. Boston Official Micro Bartender Guide

Concept Development Associates,
Inc.
7960 Old Georgetown Road
Suite 2D
Bethesda, MD 20814
(301) 951-0997

List Price: \$49.95

Requires: Apple II Plus, IIe, or IIc; 48K
RAM; one disk drive; DOS 3.3

CIRCLE 386 ON READER SERVICE CARD

Personality Profile

Psychological Psoftware Corp.
4757 Sun Valley Road
Del Mar, CA 92014
(619) 481-4182

List Price: \$39.50

Requires: Apple II, II Plus, or IIe; 48K
RAM; one disk drive; DOS 3.3

CIRCLE 387 ON READER SERVICE CARD

Pilot Log

DHLM Specialty Software
9903 Glen Canyon Drive
Dallas, TX 75243

List Price: \$29.95

T·H·E HANDLERS

VALUE • POWER • SOPHISTICATION • SIMPLICITY

- The Handlers is a software package of three programs; word processing, file management and a spell checker for the Apple II, II+, IIe and IIc.
- The Handlers is *the* answer to programs that cost a lot, take a lifetime to learn and then don't deliver!
- The Handlers delivers the power and sophistication of large scale mainframe systems.
- The Handlers makes immediate sense to the beginner and the experienced computer user.
- More and more people are selecting the Handlers over Appleworks. *Why?* Because the Handlers beats Appleworks for power, ease of use and price! We took the difficulty out of the program when we engineered it so you get what you want out of the Handlers without wasting time.

WORD HANDLER

This best selling WP is surprisingly powerful and yet easy to use.

- Global search & replace
- Block moves
- 40, 66 & 80 column
- Form generator
- Easy to remember mnemonic commands
- Unlimited tabs
- Bold, underline, superscript, justification
- What you see on screen is what you get

LIST HANDLER

A truly fast & efficient file management program.

- Over 3,000 records per disk
- Up to 200 characters per field and 255 fields per record
- Unlimited sorting fields
- Sorts alpha, numeric and date sorts
- Merges with word processors, create form letters
- Sorts 3,000 records in under 45 seconds

SPELL HANDLER

The spell checker that works hand in glove with the Word Handler.

- 90,000 words on one diskette
- Add up to 2,000 of your own words
- No disk swapping
- Scans 10 words per second
- Word count
- If you knew what we know about our products, you'd be our next customer!

als Advanced
Logic
Systems, Inc.

1195 E. Arques Avenue • Sunnyvale, CA 94086 • 408/730-0307

CIRCLE 117 ON READER SERVICE CARD

Requires: Apple II Plus or IIe; 48K RAM; one disk drive; printer
CIRCLE 388 ON READER SERVICE CARD

Plantin' Pal

Home & Hobby Software, Inc.
 4936 Morgan Avenue South
 Minneapolis, MN 55409
 (612) 925-2591

List Price: \$29.95

Requires: Apple II or IIe; 48K RAM; one disk drive; printer

CIRCLE 389 ON READER SERVICE CARD

Relax

Synapse Software Corporation
 5221 Central Avenue
 Richmond, CA 94804
 (415) 527-7751

List Price: \$139.95

Requires: Apple II, II Plus, IIe, or IIc; 48K RAM; one disk drive

CIRCLE 390 ON READER SERVICE CARD

The Running Coach

Software Publishing Corporation
 1901 Landings Drive
 Mountain View, CA 94043
 (800) 523-6982

List Price: \$69.95

Requires: Apple II, II Plus, IIe, or IIc; 48K RAM; one disk drive

CIRCLE 391 ON READER SERVICE CARD

Stamp Collector

Andent, Inc.
 1000 North Avenue
 Waukegan, IL 60085
 (312) 223-5077

List Price: \$49

Requires: Apple II Plus or IIe; 48K RAM; one disk drive

CIRCLE 392 ON READER SERVICE CARD

Stitch Grapher

Compucrafts
 RFD 2, Box 216
 Lincoln, MA 01773
 (617) 259-0409

List Price: \$89.95

Requires: Apple II Plus, IIe, or IIc; 64K RAM; one disk drive (two recommended); printer

CIRCLE 393 ON READER SERVICE CARD

Thoroughbred Handicapping System I

PDS Sports
 950 West 190th Street
 Gateway 1
 Torrance, CA 90502
 (213) 516-6688

List Price: \$129.95

Requires: Apple II Plus, IIe, or IIc; 48K RAM; one disk drive

CIRCLE 394 ON READER SERVICE CARD

"We will match any mail order price in this issue."

We'll support, service and warranty everything we sell and stand behind it 100%. We won't charge you for shipping or handling, nor will we penalize you for using a credit card.



William F. Gollan
 President, BCP

COMPUTERS		SOFTWARE FOR IIe, IIc			
Apple IIe's and IIc's	Call	Catalyst + Classmate	94.95	President's Choice	29.95
MODEMS					
Hayes Smart 300 IIc	179.95	Z80 Soft 2 w/64k	309.95	Print Shop	34.95
Hayes Smart 1200	389.95	Prometheus Pro 1200 A	339.95	Print Shop GL	19.95
Hayes Micro IIe w/sc	149.95	Zoom Micro IIe + w/sc	159.95	Print Shop RE	10.95
PERIPHERAL CARDS & ACCESSORIES					
Disks * Surge * Fans		Microsoft			
Verbatim SS/DD (11)	12.95	DJ Investors Wks. + IIc	94.95	Run for \$	27.95
Verbatim DS/DD (11)	16.95	DJ Spreadsheet Lnk. +	149.95	Sargon III	34.95
Curtis		Titan		Robot Odyssey	34.95
Diamond	29.95	Accellorator II/IIe	229.95	Rogue	20.95
Emerald	39.95	64k Ram	144.95	Serpent's Star	24.95
Ruby	59.95	128k Ram	164.95	Sideways	39.95
Kensington Sys. Sav.	64.95	Neptune 64k + 80	189.95	Simon Sch. T Tutor 3	34.95
JoySticks		Neptune 128k + 80	209.95	Solo Flight	24.95
CH Hayes Mach 3's	39.95	Neptune 192k + 80	239.95	Songwriter	27.95
Kraft	39.95	Thunder Clock	114.95	Sorcerer	29.95
Koala Graphics Pad	74.95			Spell Reader II	44.95
GRAPHIC INTERFACES & BUFFERS					
Fingerprint +	99.95	Grappler + RS232	84.95	Spellcopter	24.95
Orange Micro	Call	Grappler w/16k	154.95	Spell II	34.95
Grappler C	Call	Grappler w/64k	174.95	Squire	34.95
Grappler +	84.95	Hot Link IIc	Call	SSI	
PRINTERS DOT MATRIX					
Apple Imagewriter	499.95	Epson FX 100 +	494.95	Baseball	27.95
Apple Scribe	249.95	Gemini SG 10	239.95	Gemstone W.	27.95
Citizen MSP 10 160	294.95	Gemini Radix SR 10	509.95	Golf	27.95
Citizen MSP 15 160	429.95	Gemini Radix SR 15	609.95	War Russia	49.95
Citizen MSP 20 200	429.95	Okidata 192	374.95	Reforger 88	39.95
Citizen MSP 25 200	549.95	Okidata 192 Image.	399.95	Tigers in Snow	27.95
Epson LQ 1500	899.95	Okidata 193	514.95	Objective Kursk	27.95
Epson LX 80	239.95	Okidata 84	659.95	Mission Crush	27.95
Epson LX 80 F/T	279.95	Toshiba P1340	584.95	Germany 85	39.95
Epson FX 80+	359.95	Toshiba P351	1199.95	Battle Norm.	27.95
SOFTWARE FOR IIe, IIc					
Word Processing		GATO		27.95	
Bank Street Writer	44.95	Gertrudes Secret	29.95	Bag of Tricks	27.95
Bank Street Speller	44.95	Gertrudes Puzzle	29.95	Beneath Apple DOS	14.95
Format II Enh.	89.95	Ghostbusters	27.95	Beneath Apple ProDOS	14.95
Homeward	44.95	Golf's Best	35.95	Barron	34.95
Homeward Speller	34.95	Gorens Bridge	54.95	Beyond Castle Wolf	24.95
Megaworks	79.95	Graphic's Dept.	74.95	Bruce Lee	27.95
PFS Write	74.95	Graphics Magician	34.95	Cat Graphics	24.95
Sensible Speller IV	74.95	Hitchhikers Guide	27.95	Champ Lode Runner	24.95
Screenwriter Pro	79.95	Kids on Keys	19.95	Charlie Br's ABC	27.95
Think Tank	89.95	Kindercomp	19.95	Classmate	34.95
Business & Personal		Kings Quest	34.95	Chopflifer	24.95
Appleworks	199.95	Koala M Keys	49.95	Computer SAT	54.95
Arrays GL,AR,AP (ea)	154.95	Loade Runner	24.95	Conan	27.95
ASCII Exp. Pro	84.95	M Lge. Baseball	27.95	Cutthroats	27.95
Baudville		Magic Paintbrush	24.95	Dallas Quest	24.95
Actors & Action	20.95	Master Type	27.95	Dazzle Draw	35.95
Business	34.95	Math Blaster	32.95	Deadline	34.95
Heroes & Vill.	20.95	Mastering SAT	99.95	Delta Draw	34.95
Pixit	34.95	Micro		Dig Dug	19.95
Take-1	37.95	Cookbook	27.95	Dragon World	27.95
Beagle		Deserts	9.95	Epyx Baseball	Call
Dbl. Take	25.95	Soups	9.95	Exp. Amazon	24.95
Flex Text	20.95	Appetizers	9.95	Exodus Ultima III	45.95
Frame Up	20.95	Millionaire	34.95	F-15 Strike	24.95
Pronto DOS	20.95	Mind Prober	34.95	Facemaker	24.95
Silicon Sal.	17.95	Minit Man	19.95	Fahrenheit 451	27.95
Utility City	17.95	Moptown Parade	27.95	Felony	24.95
D-Code	27.95	Muppet Learning	49.95	Flight Simulator II	34.95
Disk Quick	19.95	Murder by Dozen	24.95	MACINTOSH SECTION	
DOS Boss	17.95	NATO Comm.	24.95	Basic 2.0	89.95
Basic	25.95	Night Pinball	24.95	Business Pack	349.95
Mechanic	19.95	Paper Graphics 1,2 (ea)	34.95	Chart	79.95
GPLE	30.95	Pensate	24.95	Enhancer	169.95
Graphics	37.95	Pattern Maker	27.95	Entrepreneur	34.95
I/O Silver	20.95	Peanuts Maze	27.95	File	119.95
Triple Dump	27.95	Peanuts Pictures	27.95	Learn Mul/Chart	39.95
Fat Cat	25.95	Personal Net W.	54.95	Logo	79.95
Bag	20.95	Planetfall	27.95	Multiplan	119.95
Boston Diet	54.95	Pole Position	20.95	Word	119.95

BC BUSINESS COMPUTERS OF PETERBOROUGH Gollan Co., Inc. **FREE SHIPPING CONTINENTAL USA/UPS ONLY**

766 RT. 101 W. • P.O. Box 772 • Peterborough, NH 03458

MasterCard VISA APO/FPO WELCOME

ORDERS ONLY: **800-845-3003** QUESTIONS: 603-924-9406

It doesn't have to be complicated to be powerful.

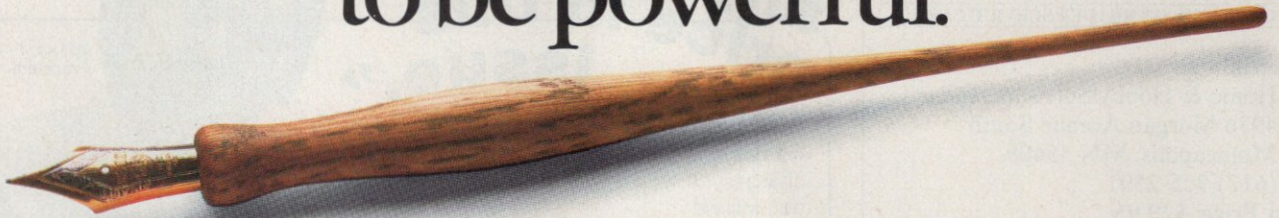

The pen has always been one of the most powerful ways to exchange information and ideas. Yet it's not a complicated tool.

PFS®:WRITE is a word processing program that's so powerful, it can meet all your business writing needs. Yet it's so uncomplicated, it's amazingly easy to learn.

WRITE is designed for people without computer expertise. All instructions are written in plain English so you can be productive right away.

With just a few keystrokes, you can make insertions and deletions, create bold face type, even move whole blocks of text.

And if you ever need it, help is just a keystroke away.

Unlike most word processing software, WRITE prints exactly what you see on the screen. Since WRITE's screen resembles a standard sheet of paper, you'll always know what your document will look like *before* you print. With WRITE, it's easy to get it right the first time.

PFS:PROOF is the perfect companion to WRITE. PROOF checks WRITE documents for spelling, typographical errors, irregular capitalization and repeated words. All with just a touch of a key.

WRITE is fully integrated with the PFS Family of Software. So it's easy to use information from other PFS programs and get more done in less time. For example, you can produce personalized form letters complete with addressed envelopes from data stored with PFS:FILE. You can even add a pie chart to the letter, created with PFS:GRAPH, to further illustrate a point.

PFS — it's the powerful software that's simple to learn. It's the power of simplicity.

See your computer dealer for a demonstration and discover how powerful the power of simplicity really is.

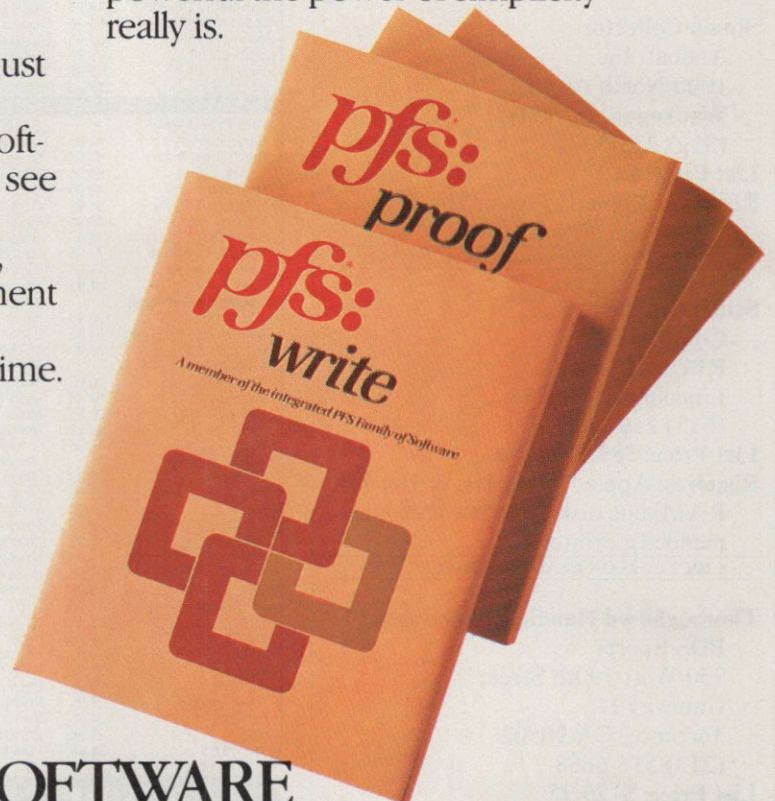

PFS SOFTWARE
The Power of Simplicity™

PFS:WRITE runs on Apple IIc and IIe, * IBM, * Compaq, Tandy, * Panasonic, Data General, Hewlett Packard, and other personal computers. * PFS:PROOF also runs on these personal computers.
© Software Publishing Corporation

A CLOSE LOOK AT RECENT ENHANCEMENTS



As reported by J. Anthony Dirksen in the cover story of the April issue of *A+*, Apple Computer, Inc., announced an interesting enhancement to the Apple IIe in March 1985: four new chips to replace the 6502 microprocessor, the character-generator ROM, and the Applesoft and system-monitor ROMs in the original version of the IIe.

In his April article, Dirksen presented a general overview of the IIe enhancements. In this article, we will take a more detailed look at the enhancements and see how they improve the performance of the Apple IIe.

The main reasons for the enhancement were to make the IIe more compatible with the IIc and to facilitate the development of mouse-driven software. Apple did so by including 32 graphic icons (called MouseText) in the character-generator ROM and by rewriting the system-monitor output subroutine to work with them. Other reasons for the changes were to allow lowercase command entry from Applesoft and the system monitor; to improve the way the IIe responds to interrupts from peripheral devices; and to fix a few minor, but annoying, bugs that had cropped up in the code stored in the original IIe ROMs.

Despite the ROM changes, most programs written for the original IIe run properly on the enhanced IIe. Just to be safe, however, Apple informed most major software developers of the proposed ROM change well in advance of the public announcement, so that incompatibility problems could be cleared up before the new ROMs were in the hands of the general public.

All Apple IIe units manufactured after March 1985 were shipped with the four new chips already installed, and owners of the original IIe can have the chips installed by an authorized Apple dealer for about \$70.

When you turn on an enhanced Apple IIe, the message Apple //e appears

at the top of the screen (the original Apple IIe displays Apple)(). You can also examine two identification bytes in the system monitor to determine what version of the Apple II you are using. With this knowledge, you can write software that can use subroutines appropriate for your Apple II model.

































PRI-MARY	ALTER-NATE	HEXI-DECIMAL	PRI-MARY	ALTER-NATE	HEXI-DECIMAL
@		\$40	P		\$50
A		\$41	Q		\$51
B		\$42	R		\$52
C		\$43	S		\$53
D		\$44	T		\$54
E		\$45	U		\$55
F		\$46	V		\$56
G		\$47	W		\$57
H		\$48	X		\$58
I		\$49	Y		\$59
J		\$4A	Z		\$5A
K		\$4B	(	\$5B
L		\$4C	\		\$5C
M		\$4D)		\$5D
N		\$4E	^		\$5E
O		\$4F	_		\$5F

Figure 1: MouseText characters

The value stored at location \$FBB3 (all hexadecimal numbers in this article have the prefix \$) distinguishes an Apple IIe or IIc from other members of the Apple II family. If it's \$06, then you're either working with the IIe (original or enhanced version) or the IIc. The value stored at \$FBC0 indicates the precise version: \$EA for an Apple IIe with original ROMs, \$E0 for a IIe with the enhanced ROMs, and \$00 for a IIc.

The New 65C02 Microprocessor

The new microprocessor for the Apple IIe, the 65C02, is the same as the one in the Apple IIc. As its name suggests, the 65C02 is a close relative of the 6502, which it replaces. In fact, every program that runs with the 6502 can also run with the 65C02 (with rare exceptions). The converse is not true, however, since the 65C02 has some ten instructions that are unknown to the 6502. Here are brief descriptions of these new instructions:

- BRA—Branch relative always
- DEA—Decrement accumulator
- INA—Increment accumulator
- PHX—Push the X register onto the stack
- PHY—Push the Y register onto the stack
- PLX—Pop the X register from the stack
- PLY—Pop the Y register from the stack
- STZ—Store zero in memory
- TRB—Test and reset memory bits with accumulator
- TSB—Test and set memory bits with accumulator



The actions of the first eight new instructions should be obvious to those who are familiar with assembly language. The last two instructions, however, require further explanation. TRB clears to 0 (resets) any bits of a byte at a given address, if the corresponding bit in the accumulator is 1. Conversely, TSB sets to 1 any bits of a byte at a given

BACKUP PROTECTED SOFTWARE with COPY II PLUS™ ver. 5

From the team who first brought you COPY II PLUS in 1981 comes a completely updated disk backup utility for your Apple // computer. New features include:

- **Fully automatic bit copy***. All parameters are stored on disk. Simply type in the name of the program you wish to backup, and COPY II PLUS does the rest!
- **New utilities** including Alphabetize Catalog, Fast 2-pass Disk Copy on a //c or //e, and an all-new Sector Editor.
- **Supplied on a standard DOS** diskette. Runs on the Apple //, Apple //+, Apple //e, Apple //c. Requires 64K and one or two disk drives.

Increase the power of your Apple //...
Use COPY II PLUS™ 5.0

Call M-F 8-5:30 (W. Coast time) with your   : 503/244-5782.
Or send a check (add \$3 s/h, \$8 overseas) to

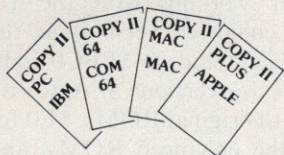

\$39.95

CENTRAL POINT Software, Inc.

9700 SW Capitol Hwy. #100
Portland, OR 97219

* We update Copy II Plus regularly to handle new protections; you as a registered owner may update at any time for 1/2 price! (To update, just send original disk and \$20.)

This product is provided for the purpose of enabling you to make archival copies only.

CIRCLE 185 ON READER SERVICE CARD

en address, if the corresponding bit in the accumulator is 1. The TRB and TSB instructions are most useful for clearing and setting software flags or manipulating the control registers of peripheral devices.

The 65C02 also supports two new useful addressing modes that some of its instructions can use: Absolute Indirect and Zero-Page Indirect.

Absolute Indexed Indirect. This addressing mode works only with the JMP (jump) instruction. Its assembler form is JMP (\$1234,X). The computer calculates the effective address by first adding the value of the contents of the X-register to the address specified in the operand to get an intermediate location. The address stored at this intermediate location and the next location (two one-byte values to hold the 16-bit address) is the effective address, that is, the address to which the JMP instruction will pass control.

Zero-Page Indirect. The operand for this addressing mode is a single byte that represents a location in zero page (the first 256 bytes of memory). The effective address is simply the address stored at this location and the very next one. Thus, the Zero-Page Indirect mode is the same as the 6502's Zero-Page Indexed Indirect mode, but without the X indexing. You use an instruction of the form STA (\$E0) with an assembler to select the Zero-Page Indirect mode.

Minor Differences

Several minor differences between the 6502 and 65C02 may affect the performance of some programs. For example, the execution times for some instructions are different, the BIT instruction behaves differently when you use the Immediate Addressing mode, and an indirect JMP command on a page boundary is handled differently. Because of a 6502 design error, a JMP (\$xxFF) instruction transfers control to the address stored at \$xx00 and \$xxFF, not \$(xx+1)00 and \$xxFF, as you might expect. This instruction behaves properly on the 65C02.

If you want more information on the 65C02's instruction set and addressing modes, read the data sheet for the NCR Corporation version of the 65C02 (in the programmers' guide of the documentation that comes with the enhancement).

By the way, the C in 65C02 stands for CMOS, which stands for Complementary Metal Oxide Semiconductor—the name for the manufacturing process of the transistors that form the

HIGH-RES GRAPHICS SYSTEM FOR APPLE II COMPUTERS

- The **HARDWARE** has two continuous pages of 640 pixels by 384 lines of bit mapped monochrome graphics.
- Completely compatible with Applesoft High-Res commands.
- Some **SOFTWARE** features are rubberband line draw, pattern fill, plot, block move/duplicate, cut and paste, shape and font positioning, and insert standard Apple pictures.
- The software also contains a vector shape table and font maker/editor programs.
- The software supports the Apple mouse and keyboard for cursor control.
- Print a full 8 1/2" by 11" page of graphics to a dot matrix printer capable of 80 dots per inch.
- Complete **HARDWARE** and **SOFTWARE** package including fonts and shape tables for only \$595.00.

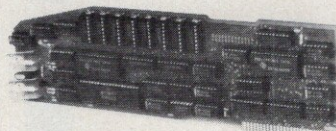

The GRAPHICS TOOL KIT

DEMCO Electronics
10516 Grevillea Ave.
Inglewood, CA 90304
(213) 677-0801

APPLE II and APPLESOFT are registered Trade Marks of Apple Computer Inc.

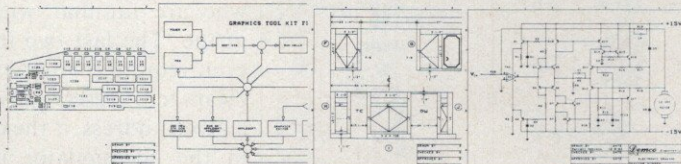

CIRCLE 171 ON READER SERVICE CARD



The Graphics Tool Kit's software supports cursor control from within the terminal on Apple IIe.

SEPTEMBER 1985	1	2	3	4	5	6	7
8	9	10	11	12	13	14	15
16	17	18	19	20	21	22	23
24	25	26	27	28	29	30	31

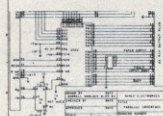
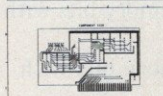



Buy Fuji Film Floppy Disks and get up to \$25 at a clip.

Now through October 15, when you buy Fuji Film Floppy Disks, you not only get a disk you can count on, you can also count on getting cash back—\$2 on any size 10-pack (3.5-inch, 5.25-inch or 8-inch), \$5 on two ten-packs, up to \$25 in total. Your local Fuji dealer has details. See him and get a quality floppy disk that helps you save more than just your data.



FUJI.

Nobody gives you better performance.

© 1985 Fuji Photo Film U.S.A., Inc., Computer Media Div., 350 Fifth Avenue, NY, NY 10118

COMPUTER NETWORK

PLEASE CALL IF YOU SEE LOWER PRICES ADVERTISED ANYWHERE! WE WANT YOUR BUSINESS! CALL OUR TOLL FREE NUMBER **800-621-0937**

BUSINESS

BPI G/A, A/R, A/P (//e only).....(ea)	\$ 237.50
GRAPHWORKS	55.95
HABA MERGE	48.50
MEGAWORKS	73.40
PEACHTREE G/L, A/R, A/P	114.30
PFS FILE & REPORT	73.40
PFS FILE & REPORT MAC.....(ea)	114.30
SIDEWAYS (Dos/Pro).....	35.20

APPLIED ENGINEERING

Z 80 PLUS (4.0 CP/M).....	108.00
VIEWMASTER 80.....	108.00
Z-RAM (//c MEM. EXP. - C/PM 256K 512K CALL	348.90
TIMEMASTER //e.....	100.25
80 COL. / 64K EXPANSION //e.....	69.95
RAM WORKS //E - 80 col/Memory Expansion card	
64K.....139.08 128K-256K-512K-1MEG CALL	
APPLEWORKS MEMORY EXP	24.95

EDUCATION

ALGEBRA 1, 2, 3, 4.....(ea)	23.45
EARLY GAMES YOUNG/CHILD.....	20.50
MASTERTYPE.....	23.45
MATHBLASTER.....	29.30
TYPING TUTOR III.....	29.30
WORDATTACK.....	29.30

WORD PROCESSING

BANK STREET FILER.....	40.99
BANK STREET SPELLER.....	40.99
BANK STREET WRITER.....	40.99
FORMAT II.....	90.00
PFS WRITE //e, //c	73.30
SENSIBLE SPELLER (Dos/Pro).....(ea)	73.30

CALL IF YOU DON'T SEE THE ITEMS YOU NEED, WE CAN HELP!

HOME/HOBBY

APPLEWORKS PREBOOT //+ Videx CALL	
COPY II (//, MAC).....	23.35
BEYOND CASTLE WOLFENSTEIN.....	20.50
CHAMPIONSHIP LODGE RUNNER.....	20.50
CUTTHROATS.....	23.45
DAZZLE DRAW.....	35.15
DEADLINE.....	29.30
DR. J & LARRY 1-ON-1.....	26.65
EXODUS:ULTIMA III.....	35.90
FLIGHT SIMULATOR II.....	29.30
HITTHIKERS GUIDE.....	23.45
HOME ACCOUNTANT //+, //c.....	43.95
KARATEKA.....	20.50
MILLIONAIRE.....	29.30
MIND PROBER.....	35.15
NEWSROOM.....	29.30
PRINTSHOP.....	29.30
PRINTSHOP GRAPHICS LIB. #1.....	16.95
PRINTSHOP PAPER REFILL.....	17.95
SARGON III //, MAC.....	29.30
SKYFOX.....	26.65
ZORK I/II/III.....	\$\$SAVE

HARDWARE

AMDEK MONITORS.....	CALL
DUMPLINGGX INTERFACE.....	61.05
HAYES MODEMS.....	CALL
MCT SPEEDEMON.....	196.50
RGB INTERFACE DVM II/III.....	127.00
SYSTEM SAVER FAN.....	59.95
QUARK HARD DISK //e, //c, MAC	\$\$SAVE

PRINTERS

C. ITOH A10-30 L/Q.....	549.00
C. ITOH 8510 AP+ NL Q 120 CPS	319.95
C. ITOH 8510 AP 120 CPS.....	299.95
EPSON ALL PRINTER MODELS.....	\$\$SAVE
TO SHIBA P1340, P1351, P351.....	CALL

DISKETTES

ELEPHANT DISKS DDDS.....	17.95
ELEPHANT DISKS SDSS.....	12.95
VERBATIM DISKS DDDS.....	22.45
VERBATIM DISKS DSSS.....	16.45
VERBATIM 3 1/2 DISK.....	26.65

For fast delivery send cashier's check, certified check or money order. Personal and company checks allow 15 days. Shipping - Software (\$2.50 min.) C.O.D. add an additional \$1.75. Shipping - Hardware (please call). MC & Visa - 3%. NM residents add 4.75% sales tax. Prices & availability subject to change without notice. Not Responsible for typographical errors. 3204 NATL. PARKS HWY., CARLSBAD, NM 8822 0

505/887-1492

CIRCLE 137 ON READER SERVICE CARD

65C02 integrated circuit. A CMOS integrated circuit consumes far less power than does a functionally identical circuit built with conventional technology. It will run cooler and can operate with a smaller power supply.

MouseText

The new character-generator ROM contains the definitions of 32 graphics icons that can be displayed on the screen if you've turned the IIe's alternative character set on. (It turns on automatically when you enter a PR#3 command to enter the 80-Column Display mode.) This set of icons is called MouseText (see figure 1).

As you can see, MouseText comprises many useful symbols, such as representations of the two apple keys,

MouseText comprises many useful symbols, such as representations of the two apple keys, different kinds of arrows, shading blocks, and so on.

different kinds of arrows, shading blocks, and so on. You can even display some of the icons next to each other to create other useful images, such as a running man or a file folder. As the name MouseText suggests, the icons are meant to be used primarily in programs that use the AppleMouse input device to point to and select commands and functions.

A MouseText icon appears on the video screen whenever a number between \$40 and \$5F is stored in the IIe's video-RAM memory. With the original IIe ROMs, these numbers correspond to inverse uppercase characters and six special symbols.

New subroutines in the IIe's 80-column firmware simplify the display of MouseText with standard Applesoft PRINT statements. Figure 2 is a short

program that prints out the entire MouseText character set.

When you've enabled the MouseText display and inverse video is on, the 80-column firmware converts printed characters with ASCII codes \$C0 (@) through \$DF () to the MouseText characters with codes \$40 through \$5F. Thus, when you run the above program, you will not see an inverse-video display of standard ASCII characters, but rather the complete MouseText character set.

The New System Monitor

You can now enter all system-monitor commands in uppercase or lowercase characters. (You can enter the system monitor by typing CALL -151 in the Applesoft Command mode.) Other improvements are the inclusion of a Search command and a simple assembler and the ability to specify ASCII codes by character rather than by hexadecimal code.

Entry of ASCII Characters

You can now use ASCII characters with the system-monitor Store command (:) or any other monitor command in a much more convenient way. Rather than entering the hexadecimal ASCII code for a character, you can precede the character itself with an apostrophe (')—that's the character on the key to the immediate left of Return. For example, use ' G instead of C7 to enter the ASCII code for G.

Here's what to enter to place the word *Inside* into memory, beginning at \$300 (don't type the asterisk—it's just the monitor's prompt symbol):

```
*300:'I'n's'i'd'e
```

Notice that each ASCII character is separated from the next by a blank space.

The Search Command

The new system-monitor ROM includes a Search command that allows you to find one- or two-byte patterns stored in a specified area of memory. To find a two-byte pattern, say ED FD, in the standard system-monitor area beginning at \$F800 and ending at

```
100 PRINT CHR$(4);"PR#3": REM SELECT 80-COLUMN FIRMWARE
200 PRINT CHR$(27);: REM TURN ON MOUSETEXT FEATURE
300 INVERSE: REM TURN ON INVERSE VIDEO
400 PRINT "@ABCDEFGHIJKLMNPOQRSTUVWXYZ[\]^_";
401 REM PRINT THE STANDARD ASCII CHARACTERS
402 REM THAT CORRESPOND TO THE SPECIAL MOUSETEXT
403 REM CHARACTERS THAT ARE TO BE DISPLAYED
500 NORMAL: REM TURN ON NORMAL VIDEO
600 PRINT CHR$(24): REM TURN OFF THE MOUSETEXT FEATURE
```

Figure 2: A program that prints out the MouseText character set

MODEM AUTO-DIAL/AUTO-ANSWER \$69.95

EPROM PROGRAMMER FOR APPLE COMPUTERS

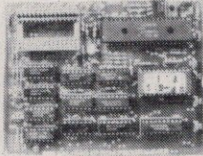

RP525
\$79.95

- * DUPLICATE OR BURN ANY STANDARD 27xx SERIES EPROM
- * EASY TO USE MENU-DRIVEN SOFTWARE INCLUDED
- * MENU SELECTION FOR 2716, 2732, 2732A, 2764 & 27128
- * HIGH SPEED WRITE ALGORITHM
- * LED INDICATORS FOR ACTIVITY
- * NO EXTERNAL POWER SUPPLY REQUIRED

DISK DRIVES FOR APPLE COMPUTERS

FOR APPLE COMPUTERS

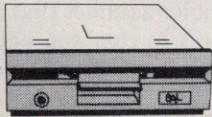

BAL-525
\$119.95

- * 1/2 HEIGHT-ALPS MECHANISM
- * 100% APPLE COMPATIBLE
- * FULL 1 YEAR WARRANTY

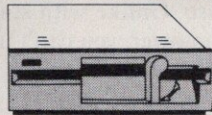

BAL-500
\$139.95

- * TEAC MECHANISM- DIRECT DRIVE
- * 100% APPLE COMPATIBLE
- * FULL 1 YEAR WARRANTY

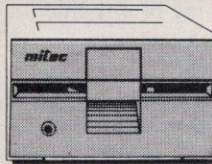

MITAC
AD-1
\$129.95

- * FULL HT. SHUGART MECHANISM
- * DIRECT REPLACEMENT FOR APPLE DISK II
- * SIX MONTH WARRANTY

DISK DRIVE ACCESSORIES

DISK CONTROLLER CARD \$49.95
APPLE IIc ADAPTOR CABLE \$19.95

NEW FOR APPLE IIc

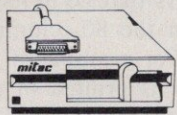

MITAC
AD-3C
\$139.95

- * 100% APPLE IIc COMPATIBLE, READY TO PLUG IN W/ SHIELDED CABLE & MOLDED 19 PIN CONNECTOR
- * FAST, RELIABLE SLIMLINE DIRECT DRIVE
- * SIX MONTH WARRANTY

TAXAN RGB VISION III SUPER HI-RES RGB MONITOR

ORIGINALLY
MADE
FOR
ACORN
COMPUTER

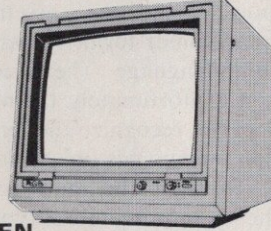

- * 12" SCREEN
- * 640 x 262 PIXELS
- * 18 MHz BANDWIDTH
- * 25 LINES x 80 COLUMN
- * .38mm DOT PITCH WITH BLACK MATRIX FOR A SHARP IMAGE AND HIGH CONTRAST

ONLY \$299.95

NO C.O.D. ORDERS PLEASE!

ORDER TOLL FREE

800-538-5000

800-662-6279

(CA RESIDENTS)

BMC MONITOR STAND MODEL PA-900

TILTS AND SWIVELS
TO PROVIDE
OPTIMUM VIEWING
ANGLE, REDUCES
OPERATOR FATIGUE

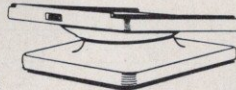

FACTORY SPECIAL \$14.95

16K RAM CARD \$39.95

- BARE PC CARD AND INSTRUCTIONS \$9.95
- * 2 YEAR WARRANTY
 - * EXPAND YOUR 48K APPLE TO 64K
 - * USE IN PLACE OF APPLE LANGUAGE CARD

APPLE ACCESSORIES

VIEWMAX-80 \$159.95
VIEWMAX-80e \$129.95
GRAPHMAX \$129.95
THUNDERCLOCK \$129.95
KRAFT JOYSTICK \$39.95
POWER SUPPLY \$49.95

MODEM FOR APPLE OR IBM FCC APPROVED

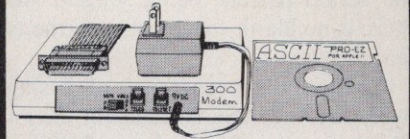

INCLUDES
ASCII PRO-EZ™
MENU DRIVEN SOFTWARE
(A \$100 VALUE IN ITSELF!)

ONLY \$69.95

- * BELL SYSTEM 103 COMPATIBLE
- * 300 BAUD
- * AUTO-DIAL/AUTO-ANSWER
- * DIRECT CONNECT
- * INCLUDES AC ADAPTOR

PLEASE SPECIFY APPLE OR IBM WHEN ORDERING

VERBATIM DATALIFE DISKETTES

SS/DD SOFT SECTOR \$29.95
SS/DD 10 SECTOR HARD \$29.95
DS/DD SOFT SECTOR \$34.95

NASHUA DISKETTES

5 1/4" SOFT SECTOR
DS/DD WITH HUB RINGS
\$.89ea. \$.95ea. \$.99ea.
QTY 250 QTY 100 QTY 50
THESE DISKETTES ARE BULK PACKAGED

DISKETTE FILE

\$8.95 IF PURCHASED WITH 50 DISKETTES OR MORE

\$9.95 IF PURCHASED ALONE

HOLDS 70 5 1/4" DISKETTES, WITH ROOM TO SPARE



RETAIL STORE - 1256 S. BASCOM AVENUE
HOURS: M-W-F, 9-5 TU-TH, 9-9 SAT, 10-3

PLEASE USE YOUR CUSTOMER NUMBER WHEN ORDERING

TERMS: Minimum order \$10.00. For shipping and handling include \$2.50 for UPS Ground and \$3.50 for UPS Air. Orders over 1 lb. and foreign orders may require additional shipping charges - please contact our sales department for the amount. CA. residents must include 6% sales tax, Bay Area and LA residents include 6 1/2%. All merchandise is warranted for 90 days unless otherwise stated. Prices are subject to change without notice. We are not responsible for typographical errors. We reserve the right to limit quantities and to substitute manufacturer. All merchandise subject to prior sale.

Apple is a trademark of Apple Computer Co.

JDR Microdevices

1224 S. Bascom Avenue, San Jose, CA 95128

800-538-5000 • 800-662-6279 (CA) • (408) 995-5430

FAX (408) 275-8415 • Telex 171-110

© Copyright 1985 JDR Microdevices

\$FFFF, you use the command

```
*FDED <F800.FFFF
```

When the monitor finds a matching pattern, its address appears on the screen, followed by a hyphen.

Notice that the byte pattern the command line specifies is the reverse of the actual pattern being sought. Also, there is no blank space between the two search bytes.

To find the occurrence of a single byte, say the ASCII code for *L*, anywhere in the block from \$2000 to \$2FFF, use the command

```
*'L <2000.2FFF
```

You can still specify the ASCII code for *L*, of course, instead of using the tick notation.

The Mini Assembler

Another useful addition to the system monitor is a "mini assembler" that you can utilize to enter 6502 programs quickly in the assembly-language (mnemonic) form, rather than in machine-language (hexadecimal) notation. Unfortunately, the mini assembler does not recognize the ten new instruction mnemonics unique to the 65C02.

To enter the mini assembler from the system monitor, type the ! com-

mand, after which the mini assembler's ! prompt symbol will appear and you can start entering a program.

To enter a program line, first type the address of the 6502 instruction, a colon, and then the instruction mnemonic and its operand. If you do these steps properly, the starting address of the instruction, the hexadecimal bytes for the instruction, and the instruction mnemonic and operand will appear on the screen. If you make a mistake, you will hear a beep, the line will reprint, and a ~ will appear beneath the character that caused the error.

After you've successfully entered the first line, you can put in subsequent lines by just typing a space and then the next instruction; the generated code will end up in succeeding memory locations.

The mini assembler assumes that all numbers and addresses that you enter are in hexadecimal form, even if you don't use a leading \$. The instruction mnemonics and operand formats that it recognizes are the standard ones that most assemblers use. Unlike with standard assemblers, however, you can't use symbolic labels for memory locations or data.

To leave the mini assembler and return to the system monitor, press Return at the beginning of any line.

Changes in Escape Sequences

Two new keyboard Escape sequences have been added to the IIe's standard input subroutine: Escape-Control-D and Escape-Control-E.

Escape-Control-D disables the printing of any control characters that are sent to the standard output subroutine, other than the codes for carriage return (\$8D), line feed (\$8A), backspace (\$88), and bell (\$87). The IIe reacts in special ways to several other control characters that go to its output subroutine when the 80-column firmware is in use. For example, if a Control-U character is printed in the 80-Column mode, the 40-column display will be turned on.

This method is handy for exiting from the 80-Column mode, but what if you happen to be communicating with a remote computer through a modem and it sends you a Control-U character for some reason? Before you know it, you will pop out of the 80-Column mode, and you will be left scratching your head, wondering what happened. To avoid this type of trouble, you should enter the Escape-Control-D sequence before running such a program. You

80¢ per disk?

And that **INCLUDES** the Tyvek sleeve, too?

SS/DD
5 1/4"
for use
with:

Apple
Commodore
Atari
Epson
TRS-80

25
Verbatim disks
For only
\$ 20.⁰⁰

- Sold in multiples of 25 ONLY
- 100% guaranteed with reinforced hubs
- Tyvek sleeves & write protect tabs included

Send your order to: Disk Offer, SoftKey Publishing, PO Box 110816-AD, Tacoma, WA 98411. Please enclose \$3 shipping and handling for the first set PLUS \$1 for each additional set. Foreign orders add 20% shipping & handling; US funds drawn on US bank. Washington state residents add 7.8% sales tax. Orders shipped via UPS; please use street address.

Please send me _____ sets (25 disks per set) of 5 1/4" SS/DD diskettes. I have enclosed \$20.00 PLUS shipping & handling for each set.

Name _____ AD

Address _____

City _____ St _____ Zip _____

Country _____

VISA/MC _____ Exp. _____

Signature _____

warning

You are entering **DANGEROUS** territory.

The Book Of Softkeys **TEARS INTO** copy-protection, **RIPS AWAY** the mystery of making backups for commercial programs and **BEATS THE COMPETITION** when it comes to providing information for the serious Apple [I] computer user!

If you want to **make BACKUPS**, then YOU WANT
The Book Of Softkeys Vol. I

(compiled from 8 previous issues of Hardcore Computing and COMPUTIST magazines)

The **ONLY** resource that teaches you
how to **BACKUP** your expensive Apple [I] software!

Send \$20.00 (US funds only) TODAY to: The Book Of Softkeys Vol. I, PO Box 110846-AB, Tacoma, WA 98411. Washington state residents add 7.8% sales tax; foreign orders add 20% shipping and handling. VISA/MC also accepted (signature and expiration date required).

CIRCLE 343 ON READER SERVICE CARD

Expanding Your IIC Is Easy With Z-RAM

Applied Engineering and Apple computer have teamed up to take your IIC to new heights.

Applied Engineering's Z-RAM card for the IIC is available with 256K or 512K of additional memory and a powerful Z-80 microprocessor for running CP/M software.

Z-RAM fits neatly inside the IIC. Installation is easy, clear instructions show you how. You'll need a screwdriver and about 10 minutes (if you can change a light bulb you can install Z-RAM).

Z-RAM and Appleworks will knock your socks off.



A 256K Z-RAM will give you a 229K available desktop and Appleworks will be completely loaded into memory. Appleworks will now run about 10 times faster in your IIC with 1 disk drive than in other IIC's with 2 disk drives. A 512K Z-RAM will give you a 413K available desktop. A 256K Z-RAM can be upgraded to 512K by just plugging in more memory chips.

Z-RAM is also a high speed solid state disk drive. With Z-RAM, your programs will load and save over 20 times faster. Z-RAM's RAM disk is compatible with Applesoft, ProDOS, DOS 3.3, PASCAL and CP/M. And with Z-RAM, you can copy a disk in one pass. Just insert the original, remove the original, insert blank disk! That's it! Z-RAM is another disk drive, only 20 times faster, 4 times larger capacity, and no whirring, clicking or waiting!

But before you start panting over all that extra memory, don't forget that the Z-RAM card has a built-in high speed Z-80 processor chip that allows you to run CP/M programs like Wordstar, dBASE II, Turbo PASCAL, Microsoft BASIC, FORTRAN and COBOL and over 3,000 other CP/M programs. So Z-RAM not only makes Apple programs run better and faster, it lets you run MORE programs.

With the Z-RAM card installed, your IIC is still your IIC only now you'll have that extra memory that Appleworks

and other programs need. And you can run all that great CP/M software that others can only dream about.

Z-RAM is 100% compatible with all IIC software and hardware including the mouse, 2nd disk, modem and printer. Z-RAM is easily handled by the IIC power supply as power consumption is kept very low by using two custom integrated circuits and a patent pending power saving design. And Z-RAM is from Applied Engineering, the acknowledged leader and innovator of accessories for the Apple.

Z-RAM comes complete with manual, RAM disk software, Z-80 operating system, CP/M manual and a 3 year no hassle warranty.

So the next time somebody asks you why you didn't get an IBM P.C., tell him you bought a IIC because the IBM didn't have enough memory and was too slow and couldn't run CP/M software. And tell him you made it past the 8th grade.

Z-RAM with 256K

\$449

Z-RAM with 512K

\$549

If you want to run CP/M software, but don't need more memory, may we suggest our Z-80c card. The Z-80c offers the same CP/M performance as Z-RAM but has no memory expansion ports. And the Z-80c will not affect the running of Apple programs. The Z-80c is priced at only \$159.00 and should you ever want to upgrade to Z-RAM, we'll refund your full purchase price.

Call (214) 241-6060

9 a.m. to 11 p.m. 7 days a week or

Send check or money order to:

Applied Engineering

P. O. Box 798

Carrollton, Texas 75006



MasterCard



Visa and

C.O.D. welcome. No extra charge for credit cards.

Texas residents add 5% sales tax. Add \$10.00 if outside U.S.A.



APPLIED ENGINEERING
"We Set the Standard"

quikLoader™

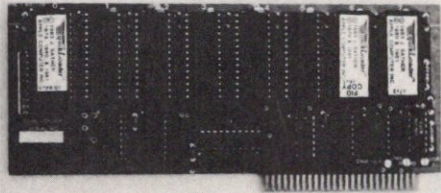

designed by Jim Sather

- **Instantly** loads DOS.
- **Instantly** loads programs.
- Stores up to 512K of programs on EPROM.
- Stores and catalogs up to 255 programs.
- Directions included to load your own software (requires EPROM programmer card).
- Plugs into any slot of the APPLE][+ or //e.
- Uses standard 27 series EPROMs up to 27512.
- Allows turnkey operation.
- Commercial programs available.
- Includes DOS, FID, COPYA, and Integer.

The benefits of quikLoader™ start when you turn on the computer. Standard DOS is *instantly* loaded. You may then catalog the programs available on the card by pressing **Q-reset**. Typing the index letter that appears on the left of the program name causes that program to be *immediately* loaded. We start your library of programs with the most popular utilities on EPROM, FID and COPYA. Now, if you have to copy a disk, you don't have to search for the master disk. You can start copying within 3 seconds after powering on.

Saving your own programs onto EPROM (Erasable Programmable Read Only Memory) is easily done, using a separate EPROM programmer (such as the PROMGRAMER™). For APPLESOFT™, Integer, or single machine language files, no programming knowledge is necessary. You will need experience if you want to save copy-protected or complex programs. The amount of experience necessary depends on the complexity of the program.

SYSTEM REQUIREMENTS

The quikLoader plugs into any slot of the][,][+, or //e. If installed in a][+, a slightly modified 16K card in slot 0 is suggested. A disk drive is required to save data.

\$179.50

DOS, Integer basic, FID, and COPYA are copyrighted programs of APPLE COMPUTER INC. licensed to SOUTHERN CALIFORNIA RESEARCH GROUP to distribute for use only in combination with quikLoader.

9-16 Adapter

For Apple //e and //c

This product permits the use of most 16 pin I/O devices with the APPLE //c or //e. By plugging this adapter into the sub-miniature 'D' connector, (in back of the computer), you can plug in a 16-pin device, such as the PADDLE-ADAPPLE, paddles, joystick, KOALA PAD™, etc. The only limitations are those devices that use the annunciators or the C040 strobe, such as the POWER PAD™. Please note that the //c does not support 2-joystick games.

\$14.95



16-9 Adapter

For Apple][+ or //e

This product permits the use of all 9-pin game I/O devices with the APPLE][+. By plugging this adapter into the internal 16-pin connector, you can plug in any 9-pin game device, such as paddles, joysticks, KOALA PAD™, Muppet Learning Keys™, etc.

\$14.95

PROMGRAMER

designed by Bob Brice

software by Bob Sander-Cederlof

The PROMGRAMER will read or program any of the standard single voltage EPROMS, from the 2708 to the 27512. Features include:

- Slot independent operation for the APPLE // family of computers.
- Zero-insertion force sockets accepts 24 or 28 pin devices.
- Choice of standard or fast programming algorithms.
- Disk-based software allows easy customization of software
- Source code included.
- Complete instructions for loading software into quikLoader™.

\$149.50

EXTEND-A-SLOT

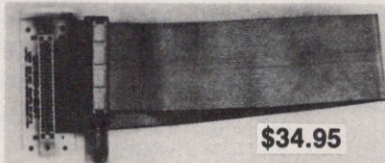

\$34.95

The EXTEND-A-SLOT brings a slot outside your APPLE™, allowing an easy change of cards. The 18" flex cable is long enough to allow placement of the card in a convenient location. The high quality connectors are gold plated for reliability.

EASY TO USE—just plug it in as you would any expansion card, then plug your card in. When you want to change cards, do it easily outside the computer, without the wear and tear on the computer expansion slot.

Paddle-Adapple

GAME I/O ADAPTER AND EXTENDER



- Works with all APPLE™ compatible joysticks, paddles, and most other I/O devices.
- Select one of two devices or...
- Use two joysticks simultaneously
- Suggested for One-on-One™, Archon™, etc.
- Unique "JUMPERS" socket allows you to configure to meet your needs.
- Plugs into internal 16-pin game I/O port.
- Small and compact. Adheres to computer with supplied foam tape.
- All strobes, annunciators and power available on all 16 pin sockets.
- Supplied with 18" cable.

\$29.95

SWITCH-A-SLOT



designed by Joy George

The SWITCH-A-SLOT is an expansion chassis, which allows the user to plug in up to four peripheral cards at one time. One of these cards is selected for use, and only that card draws power.

This product is especially useful where the software requires the printer to be in a particular slot, and the user wishes to choose between two or more printers.

- User selects desired card by front panel rotary switch.
- Plugs into any peripheral slot
- Saves wear and tear on delicate connectors.
- 18" cable connects SWITCH-A-SLOT to computer.
- Resistive terminations for better response.

SWITCH-A-SLOT and EXTEND-A-SLOT work well with most slow to medium speed cards, such as Modems, Printers, Clock, 80 Column, Music, etc. They are not recommended for high speed data transfer devices such as disk drive controllers, alternate processor, and memory cards. We cannot guarantee that these products will work with a particular system. We do have a money-back guarantee if it does not work for you. The SWITCH-A-SLOT is not recommended for use with the APPLE™ Mouse.

\$179.50

The PADDLE-ADAPPLE has two 16-pin sockets.

The PADDLE-ADAPPLE 'D' has two 'D' sub-miniature connectors.

The PADDLE-ADAPPLE COMBO has one 16-pin socket, and one sub-miniature connector.

SLOT 3 CLOCK

for APPLE //e and enhanced //e

NEW

designed by Chuck Shaffer

- Fully supports PRODOS™. • Applesoft™ compatible.
- Designed for slot 3 (usually otherwise unusable).
- Time and date-stamp files under PRODOS.
- Long-life lithium battery included.
- Includes software.

\$79.50

OTHER PRODUCTS

D MANUAL CONTROLLER: Gives complete control over the \$C000 through \$C0FF range in hardware. Think of it as a hardware switch for soft switches. Can be switched while program is running. **\$89.50**

MAGIC KEYBOARD (for][or][+ only) Re-encodes the keyboard to give alternate keyboards, such as DVORAK, A.S.K., 10-KEY, HEXADECIMAL KEYPAD, etc. **\$49.50**

Available at your local dealer or direct from:

So. Calif Research Group

P.O. Box 593-A

Moorpark, CA 93021

(805) 529-2082

TELEX 658340 ATTN: SCRG

Answer Back INTERTEL SNC

VISA, MASTERCARD accepted

Add \$2.50 for shipping. Outside U.S. and Canada, \$5.00, for surface, \$10.00 Air; except Switch-A-Slot, \$25.00 Air.

**SIX MONTH WARRANTY
TEN DAY RETURN PRIVILEGE
TOLL-FREE ORDER LINES**

in CA (800) 821-0774
(800) 635-8310

all other states (Including AK, HI, VI & PR)
Information & technical questions: (805) 529-2082

can reenable the handling of the control codes later by entering the Escape-Control-E sequence.

The enhanced ROMs do not let you use the Escape-command sequences Escape-R and Escape-T. In the original ROMs, these sequences activate and deactivate an input mode in which all lowercase text that is not entered within quotation marks is converted to uppercase. This mode is no longer required, since you can now enter Applesoft and system-monitor commands in both uppercase and lowercase characters.

Interrupt Handling

The Apple II, II Plus, and original IIe handle interrupt requests (IRQs) badly because both DOS 3.3 and the system monitor use location \$45 for data storage. The problem arises because this location is overwritten when an interrupt occurs, which obliterates its proper contents. With the enhanced IIe ROMs in place, however, the integrity of \$45 is preserved and interrupts go smoothly.

When a peripheral device makes an interrupt request on the enhanced IIe, control now passes to the IIe's internal interrupt-handling subroutine at location \$C3FA. This subroutine ultimately passes control to NEWIRQ at

\$C400. NEWIRQ is responsible for saving the state of the system when the interrupt occurs and then setting it to the following standard state:

- Main memory is active for reading and writing.
- The ROM space from \$D000 to \$FFFF is active.
- The main stack and zero page are active.
- The main text page is active.
- If the alternative stack is active, the current stack pointer is stored at \$101 (in the alternative stack), and the main stack pointer is set equal to the value stored at \$100 (in the alternative stack). For this scheme to work properly, any program that turns on the alternative stack must also store the value of the main stack pointer at \$100. Here's the code that will do the trick:

```
PHP      ;Save status
SEI      ;Disable interrupts
          ;for this
STA $C009 ;Turn on alternative
          ;stack
TSX      ;Transfer SP to X
STX $100 ;Save main SP
PLP      ;Restore interrupt
          ;status
```

After the subroutine has saved the value of the main stack pointer at \$100, NEWIRQ sets up the alternative stack pointer.

Once NEWIRQ has set up this standard state, the interrupt handler calls the user's own interrupt handler (its address is stored at \$3FE/\$3FF). After it finishes (with an RTI—return from interrupt—instruction), the system goes back to its original state, and control returns to the interrupted program.

Slot 3 Peripheral Cards

When you turn an original Apple IIe on or press Reset, the internal slot-3 firmware is always enabled if an 80-column text card is installed or disabled if it is not.

The situation is different with the enhanced Apple IIe. If slot 3 contains a peripheral card that has the identification bytes \$C305 = \$38 and \$C307 = \$18, then the peripheral-card slot-3 firmware is turned on, even if an 80-column text card is also installed. Thus, the slot-3 peripheral, not the 80-column text card, will be used when you enter a PR#3 command.

The firmware in such a slot-3 peripheral card must contain a special sequence of four instructions beginning at \$C3F4 to use the IIe's new internal in-

PIK'EM 85



A Complete Pro Football Prediction Program For The 1985 NFL SEASON

63% + Accurate vs 'Spread' Since 1981
More Features — More Information In 1985 To

BEAT THE SPREAD

★ ★ FEATURES ★ ★

- Predicted Scores Each Week
- Season Schedule By Week/Team
- Records & Results:
 - Scores By Week
 - Scores By Team
 - Division Standings
 - Stats — Accumulated & Average 1983-1984 Data Base
- Auto Opponent Input
- Auto Data Update
- Printed Copy All Screens
- Easy Update—Playoffs/1986
- Dealer Inquiries Invited

49⁹⁵ INCLUDES DISC DOCUMENTATION

- Apple II — IIe — III
- Commodore 64
- IBM PC
- TRS-80, MIII/IV
- Tandy 1000/1200/2000

STATS NEEDED TO RUN PROGRAM AVAILABLE IN LOCAL NEWSPAPERS OR

WE WILL FURNISH STATS BY MAIL & MODEM ALL 20 WEEKS — SEASON PRICE . . . 40⁰⁰

PROGRAM COMES UPDATED THRU CURRENT WEEK OF SEASON . . . NO EXTRA CHARGE



Orders Call Collect
24 Hrs.
C.O.D.



MARATHON SOFTWARE DEPT. A
P. O. BOX 1349
JACKSONVILLE, TEXAS 75766
(214) 586-8212

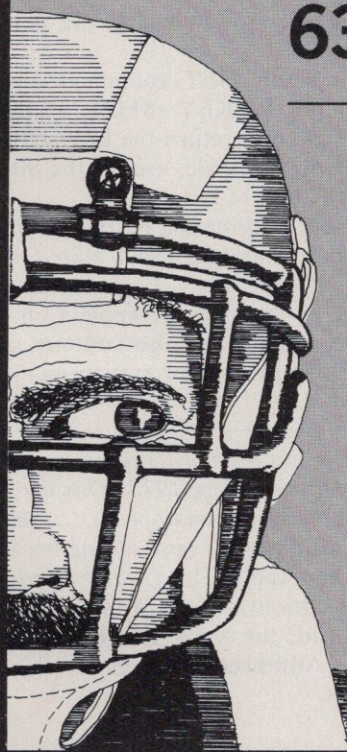

NEW
Improved Version

Replace that
graphic "artist"
with a complete



Graphics Department™

Some software packages only do charts, others only do lettering, or only "slide" showing. The menu-driven Graphics Department program combines all of these and more into one package.

Build any type of graph; add titles and other lettering; draw ellipses, points, lines, rectangles; "paint" in 100 colors; present a "slide show"; and manage your library of picture data. This new updated version of the Graphics Department can even produce area charts and 3-D pie charts, has more fonts and prints on most printers. It does it all!

Available for Apple computers for \$124.95.

Apple is a trademark of Apple Computer, Inc.

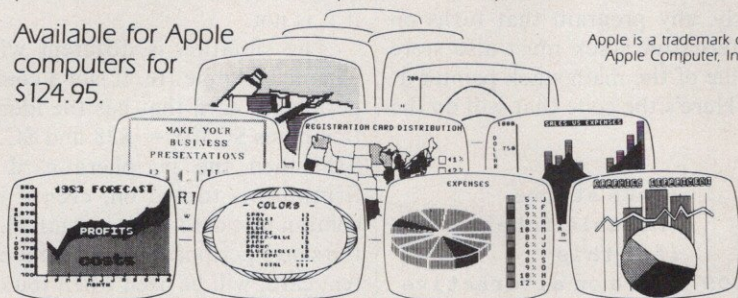

Sensible Software, Inc.®

210 S. Woodward, Suite 229, Birmingham, MI 48011
(313) 258-5566

CIRCLE 345 ON READER SERVICE CARD

Spell Checker for Appleworks only \$49.95!

Now... the luxury of a spelling checker for only \$49.95!

Spellworks was written exclusively for Appleworks... it fits Appleworks like a glove. Typing and spelling errors are a thing of the past when you use Spellworks! If you've got Appleworks, you need Spellworks. It's a steal - spelled s-t-e-a-l!

- 90,000 Words
- Checks 10 words per second
- Word count 10 per second
- All on one diskette!

If you knew what we know about our products you'd be our next customer.

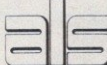

... no more
spelling errors!

Advanced Logic  Systems, Inc.

1195 E. Arques Avenue • Sunnyvale, CA 94086 • 408/730-0307
CIRCLE 118 ON READER SERVICE CARD

interrupt-handling subroutine:

```

$C3F4: STA $C081 ;Read ROM,
          ;write RAM
        JMP $FC7A ;
        BIT $C015 ;Get inter-
          ;nal "$Cx"
        STA $C007 ;ROM status
          ;Select in-
          ;ternal ROM
    
```

If these instructions are not present, you will not be able to use interrupts on the new IIe.

Here are some of the more interesting features and bug fixes that have been incorporated into the new ROMs:

- You can now enter Applesoft commands in uppercase or lowercase characters.

You can now enter Applesoft commands in uppercase or lowercase characters.

- 80-column screen clearing and scrolling are dramatically faster.
- You can boot directly from a ProFile hard disk when you turn on the IIe or press Reset.
- The bug-induced Escape-Control-L sequence that transfers control to \$4CCE is gone.
- The code for the Applesoft HTAB, TAB, SPC, and PRINT commands has been rewritten to ensure that these commands work properly in the 80-Column mode.
- Even or odd window widths are now possible.
- The Applesoft GET command and the monitor RDKEY (\$FD0C) subroutine can now return the Escape or right-arrow key code, even if the 80-column firmware is active.

For more information on the Apple IIe enhancements, see *About Your Enhanced Apple IIe: Programmer's Guide*, a publication of Apple Computer, Inc. This book also contains a source listing of the new system-monitor ROM. **+**

Gary Little has been programming Apple II computers since 1978. This article is adapted from an appendix to the second edition of his best-selling book *Inside the Apple IIe (1985, Brady Communications)*. He is also the author of *Inside the Apple IIc and Apple ProDOS, Advanced Features for Programmers*.

NORTHEASTERN SOFTWARE

88 Ryders Lane, Stratford, Connecticut 06497

- Up to 50% off/software purchases over \$300 an additional 2% off
- New larger facilities to serve you better
- School & corporate purchase orders accepted
- No additional charges for credit card orders

Entertainment

Spy Hunter or Buck Rogers	27.00
Tapper or Star Trek	27.00
Congo Bongo or Up 'n' Down	27.00
Sorcerer	27.00
Cutthroats or Zork I	24.00
Zork II, III	27.00
Suspect	27.00
Deadline	29.00
Planetfall	24.00
Enchanter	24.00
Infidel	27.00
Hitchhiker's Guide	23.00
Ultima III	34.50
Lode Runner or Karateka	21.50
Choplifter	24.00
Reforger 88	36.00
50 Mission Crush	24.00
Objective Kursk	24.00
President Elect	24.00
Questron	30.00
Rails West	24.00
Battle for Normandy	24.00
Imperium Galactum	24.00
Pro Tour Golf	25.00
Ring Side Seat	25.00
Cosmic Balance II	25.00
Computer Baseball	25.00
Geopolitique 1990	24.00
Baltic 85	21.00
North Atlantic 86	36.00
Germany 1985 or Carrier Force	38.00
War in Russia	48.00
Flight Simulator II	32.00
Night Mission Pinball	22.00
Wizardry I	30.00
Wizardry II	30.00
Wizardry III	24.00
Wizardry IV	24.00
Wizardry V	24.00
Wizprint	16.00
Rendezvous with Rama	25.00
F15 Strike Eagle	25.00
Dragon World or Shadow Keep	22.00
Zaxxon	20.00
Fahrenheit 451 or Amazon	25.00
Expedition Amazon	22.00
The Quest	21.50
Coveted Mirror	21.00
Xyphus	21.50
Transylvania	21.50
Frogger	22.00
BC's Quest for Tires	21.00
Kings Quest	30.00
Wizard of Id Touch Type	19.00
Fax	19.00
Summer Games	27.00
Stellar 7	23.00
Ken Uston's Blackjack	45.00
Caverns of Frietag	20.00
Castle Wolfenstein	20.00
Beyond Castle Wolfenstein	20.00
Millionaire	30.00
Baron	30.00
Tycoon	37.00
Spiritfire Simulator	25.00
Air Sim III	26.50
Bruce Lee	26.50
Sargon III	31.00
Miner 2049er	31.00
Death in the Caribbean	21.00
The Heist	24.00
How about a nice game of Chess	21.00
Mask of the Sun	24.00
Hard Hat Mack	24.00
Pinball Const. Set	26.50
Music Const. Set	26.50
The Standing Stone	26.50
One-on-One	26.50
Archon	26.50
Skyfox	26.50
Seven Cities of Gold	26.50
Murder on the Zinderneuf	26.50
Sundog	31.00
Pitfall II	25.00
Gato	24.00
Fantasy	28.00

Blank Media

Elephant SS/DD	12.50
Elephant DS/DD	21.00
Verbatim SS/DD	17.00
Verbatim DS/DD	24.00
Memorex SS/DD	18.00
Memorex (Mac 3 1/2")	34.00
MAX II DD	15.00
Maxell SS/DD	16.00

Educational

APPLE Logo II	82.00
BARRONS Computer SAT	53.00
CBS	21.90
Mastering the SAT	92.00
Murder by the Dozen	21.90
DAVIDSON AND ASSOCIATES	
Speed Reader II	41.00
Word Attack	29.50
Math Blaster	29.50
DESIGNWARE	
Spellicopter	24.00
Crypto Cube	24.00
Spellikazam	18.00
DLM	
Alien Addition	20.50
Medior Multiplication	20.50
Demolition Division	20.50
Alligator Mix	20.50
Dragon Mix	20.50
EDU-WARE (PEACHTREE)	
Compu-Read	17.00
Compu-Math	29.00
SAT Word Attack Skills	28.00
PSAT Word Attack Skills	28.00
Spelling B w/Reading Primer	23.00
Algebra 1 2 3 or 4	22.50
Algebra 5 & 6	27.50
Hands on Basic	47.00
Fractions	31.90
Decimals	31.90
HARCOURT BRACE JOVANOVIICH	
SAT	47.00
GRE Test	59.90
HAYDEN SOFTWARE	
Micro Math (Add-Sub)	20.90
Micro Math (Multi-Div)	20.90
LEARNING COMPANY	
Ricky's Boots	30.00
Number Stumper	25.00
Robot Odyssey	30.00
Reader Rabbit	24.00
Magic Spell	22.00
Juggle's Rainbow	18.00
Bumble Games	24.00
Bumble Plot	24.00
Gertrude's Puzzles	27.00
Gertrude's Secrets	27.00
MAGNUM	
Super Speed Reading	65.00
MECA	
Basic Building Blocks	49.00
MICROLAB SAT Programs	20.00
PROGRAM DESIGN	
The New Step by Step	73.00
Step by Step II	73.00
Step by Step III	73.00
SCARBOROUGH SYSTEMS	
Scritwriter or Pictewriter	24.00
Phi Beta Pi	24.00
Master Type	24.00
SCHOLASTIC WIZWARE	
Fact & Fiction Tool Kit IIc	24.00
Microzine (1-6)	ea. 24.00
Story Tree	24.00
Turtle Tracks	24.00
SPYNAKER SOFTWARE	
Fraction Fever	19.00
Trains	21.90
Facemaker	19.00
Snooper Troops 1 & 2	27.25
Story Machine	21.90
Kindergarten	19.00
Delta Drawing	31.00
Kids on Keys	19.00
Alphabet Zoo	19.00
Hey Diddle Diddle	17.00
In Search of	25.00
Aerobics	27.00
Grandma's House	18.00
Kidwriter	19.00
SPRINGBOARD	
Early Games For Young Children	21.00
Matchmaker	19.00
Piece of Cake	21.00
Fraction Factory	19.00
SUNBURST	
The Factory	30.00
Teasers by Tobbs	30.00
TERRAPIN Logo	60.00
XEROX	
Sticky Bear ABC	24.00
Sticky Bear Numbers	24.00
Sticky Bear Bop	24.00
Sticky Bear Opposites	24.00
Sticky Bear Shapes	24.00

Business

APPLE		Call
Appleworks		Call
Apple Writer IIe	124.90	
ARTSCI		
Magic Office Systems	184.50	
Magic Calc	93.50	
Magic Window II	93.50	
ASHTON-TATE DB II	278.00	
BPI		
General Accounting	235.00	
GL, AR, AP, PR or INV	234.00	
CONTINENTAL		
Home Accountant	42.00	
Tax Advantage	41.50	
FCM/F	60.50	
G/L, A/R, A/P	144.00	
ODW JONES SOFTWARE		
The Market Analyzer	208.00	
Market Manager	148.00	
HAYDEN		
The Writer	34.00	
Pie Writer V2.2	93.00	
HOWARD SOFTWARE SERVICES		
Real Estate Analyzer II	145.00	
KENNINGTON		
Format II Enhanced	91.50	
LIVING VIDEO Think Tank II/Ile	86.00	
MEGAHAUS		
MegaFinder	98.00	
MegaSpell	38.00	
MegaWorks	Call	
MegaWriter	64.00	
MICROPRO		
Wordstar	217.00	
Calstar	48.50	
MICROSOFT Multiplan	60.00	
MICROSTUFF Crosstalk	115.00	
PEACHTREE Peach Calc	91.90	
QUARK		
Lexicheck/Word Juggler IIe	118.00	
SENSIBLE SOFTWARE		
Sensible Speller	72.00	
Bookends	72.00	
Report Card	36.50	
SIERRA ON-LINE		
The General Manager II	131.00	
Homework	43.00	
ScreenWriter IIe	78.00	
SILICON VALLEY		
The Handlers Package	102.50	
List Handler	46.90	
The Word Handler II	46.90	
SOFTWARE ARTS		
Visicalc Package	114.00	
SOFTWARE PUBLISHING		
PFS: Best Sellers	155.00	
PFS: Write	72.00	
PFS: File	72.00	
PFS: Graph	72.00	
PFS: Report	72.00	
STONEWARE		
DB Master 4 Plus	180.00	

Macintosh

PFS: File	70.00
PFS: Report	70.00
PFS: File/Report	110.00
Typing Tutor II	31.00
Millionsaire	36.00
Transylvania	24.00
Coveted Mirror	24.00
The Quest	24.00
Main Street Filer	114.00
Helix	240.00
Sargon III	30.00
McPic!	30.50
Click Art	30.00
Early Games	57.00
Home Accountant	115.00
Microsoft Multiplan	89.00
Microsoft Basic	89.00
Microsoft Chart	74.00
Microsoft Word	115.00
Mac the Knife	23.00
Zork I or II	25.00
Zork II	28.00
Master Type	29.00
1st Base	108.00
DB Master (Mac)	115.00
DaVinci (series)	ea. 30.00
Habdex	50.00
TK Solver	145.00

We fully support the Macintosh — call toll free
Apple Computers — call toll free

Printers

APPLE		
Imagewriter (10 & 15")	Call	
BROTHER		
HR-25	655.00	
HR-35	830.00	
DAISY WRITER 2000	Call	
DIABLO		
620 (RS-232C)	850.00	
630 (PC)	1,785.00	
DYNAX DX-15	375.00	
EPSON		
FX-80	Call	
FX-100	Call	
RX-80F/T	Call	
RX-100	Call	
LQ-1500	Call	
LX-80	230.00	
JX-80	Call	
Homewriter 10	Call	
JUKI 6100	389.00	
MANNESMANN TALLY		
MT-160L	605.00	
MT-180L	795.00	
MT-Spirit	295.00	
NEC INFO SYSTEMS		
N2030	680.00	
N5530	1,255.00	
P21	665.00	
OKIDATA		
Microline 82A	305.00	
Microline 83A	535.00	
Microline 92P	355.00	
Microline 93P	595.00	
PANASONIC		
KXP 1090	208.00	
KXP 1091	295.00	
KXP 1092	398.00	
KXP 1093	615.00	
PROWRITER		
8510AP	295.00	
1550AP	445.00	
8510SP	395.00	
QUIME Printers	Call	
SILVER REED		
EXP400	240.00	
EXP500P	275.00	
EXP550P	395.00	
EXP770P	700.00	
STAR MICRONICS		
SG 10	234.00	
SG 15	394.00	
SR 10	495.00	
SR 15	595.00	
SD 10	345.00	
SD 15	468.00	
TOSHIBA Printers	Call	
TRANSTAR		
120P	425.00	
130P	550.00	
315	455.00	
Pics Card	95.00	

Disk Drives

APPLE		
Disk II Drive	295.00	
Duo Disk w/acc. kit	Call	
Pro File Disk Drive	Call	
Ile Add-On	Call	
Mac Add-On	Call	
INFAK		
101 10 Meg	2,145.00	
102 20 Meg	3,350.00	
INDUS GT Slimline	250.00	
MICRO SCI		
A2 143K	188.00	
Slimline Ile	184.00	
Slimline IIC	188.00	
Micro SCI Controller	57.00	
QUENTIN		
AP 100A Full Height	198.00	
AP 105 Slimline	209.00	
AP 110A Twin Pack	410.00	
RANA		
Elite I	195.00	
Elite II	355.00	
Elite III	428.00	

Monitors

AMDEK		
Color 300	235.00	
Color 500	395.00	
Color 600	415.00	
Video 300G Green	128.00	
Video 300A Amber	138.00	
DVM II or III	130.00	
BMC		
Color Plus Monitor	239.00	
BM12 AOW Green	95.00	
PANASONIC		
TR 120 Green	145.00	
TR 120 Amber	150.00	
DTD 1300 RGB	400.00	
PRINCETON		
HX-12	469.00	
RGB Interface	155.00	
SAKATA		
SC-100 Color	244.00	
SC-200 RGB Color	454.00	
SG-1000 Green	94.00	
TAXAN		
Green (Hi-Res)	119.00	
Amber (Hi-Res)	125.00	
210 13" Color (Lo-Res)	263.00	
RGB Vision III	398.00	
410-64 RGB-2 Interface	184.00	

Specials

EDD II	45.00
Locksmith 5.0	68.00
CIA Files	47.00
Back It Up III	52.00
Copy II+	21.00
Wildcard II	98.00
Dollars & Sense/Mac	87.00
Copy Master II	Call
Copy Mac	24.00
Megaworks	Call
Network Wiretree	46.00
Apple Joystick	Call
Apple Mouse	Call
Apple Super Serial Card	115.00

Home/Accessories

Pixit	30.50
Take One	36.50
Apple Mechanic	17.00
Beagle Basic	20.00
Beagle Graphics	33.00
Disk Quick	18.00
Doss Boss	14.00
Double Take	20.00
D-Code	23.00
Fat Cat	20.00
Flex Type	17.00
Frame Map	17.00
GPLE	28.00
I/O Silver	17.00
Pronto Doss	17.00
Silicon Salad	14.00
Triple Dump	23.00
Type Faces	11.00
Utility City	17.00
Zoom Graphics	31.00
Visible 6502	32.00
Crossword Magic	31.00
Turbo Pascal	33.00
Net Worth	48.00
Bank Street Writer	41.00
Bank Street Speller	41.00
Bank Street Filer	Call
Print Shop	28.00
Graphics Library	15.00
Digital Paint Brush	198.00
Forecast	38.00
Time Trax	68.00
DATA TRANSFORMS Fontrix 1.5	58.00
Font Paks 1-11	ea. 11.50
The Accountant	60.90
Cut & Paste	34.00
Financial Cookbook	34.00
FUNK Sideways	36.00
Orca M	63.00
LAZERWARE Lisa V 2.6	54.00
AppleSoft Compiler	110.00
Typing Tutor I	15.00
Typing Tutor II	31.00
Dollars & Sense	58.00
Dollars & Sense IIc	70.00
The Graphics Magician	68.00
New Complete Graphics System	48.00
Paper Graphics	31.00
Cat Graphics	22.00
QUALITY Bag of Tricks	25.00
Merlin	37.00
Merlin Pro	44.00
Merlin Combo	68.00
SOFTRONICS Softerm II	128.00
TURNING POINT Time is Money	

PRINT-IT!™

THE NEW APPLE* COMPATIBLE SERIAL AND PARALLEL PRINTER INTERFACE



Go
From Screen
to Paper
at the Touch
of a Button!

The ONLY way to get fast, easy printouts
of ANY screen, at ANY time,
with ANY program.

Push the red button that comes with PRINT-IT! - Your program pauses instantly; touch RETURN and whatever is on your screen - text, graphics or both - is printed in color or black & white.

Whether your Apple II, II+, IIe^② or "look-alike" is for business or pleasure, you'll want the ability to pause and take snapshots of your screen displays and then continue from exactly where you paused, all at the touch of a button - games, business data, menus, educational instructions, graphics - even CP/M^③. PRINT-IT! will print your screen at any time no matter what program you're running, as well as perform every function you expect of an intelligent printer card.

PRINT-IT! supports:

- Graphics - Low, high, double low, and double high resolution • Text - 40 column as well as Apple II/e and Videx^④ 80 column cards including the new Apple 80 column RGB card
- Software - Prints from ALL software, even allows any printer to be used directly from Apple MousePaint
- Printers - All of the most popular printers,^⑤ including color, are easily selected with a dip switch.

PRINT-IT!, complete with cable (serial or parallel), is available at your local computer store now! If they don't have it in stock, ask them to get it for you.

Can't find a local dealer? PRINT-IT! is available for \$199 directly from Texprint^① Qualified educational and dealer discounts available.

TEXPRINT

Subsidiary of Computer Products Inc.
220 Reservoir Street
Needham Heights Ma. 02194
Tel. (617) 449-5808

For information call Toll Free **1-800-255-1510**

^① Visa, MC, AMX accepted. Add \$4 shipping and handling within USA. Mass. res. add 5% tax

^② Apple II, II+, IIe, and MousePaint are registered trademarks of Apple Computer, Inc.

^③ CP/M is a registered trademark of Digital Research

^④ Videx is a registered trademark of Videx, Inc.

^⑤ Apple DMP/IMAGEWRITER/SCRIBE, BMC, C. Itoh, Canon, Epson, Dataproducts, IDS, Tally, NEC, Okidata, Quadram, Panasonic, Radio Shack, Star Gemini, Transtar, Diablo plus many others.

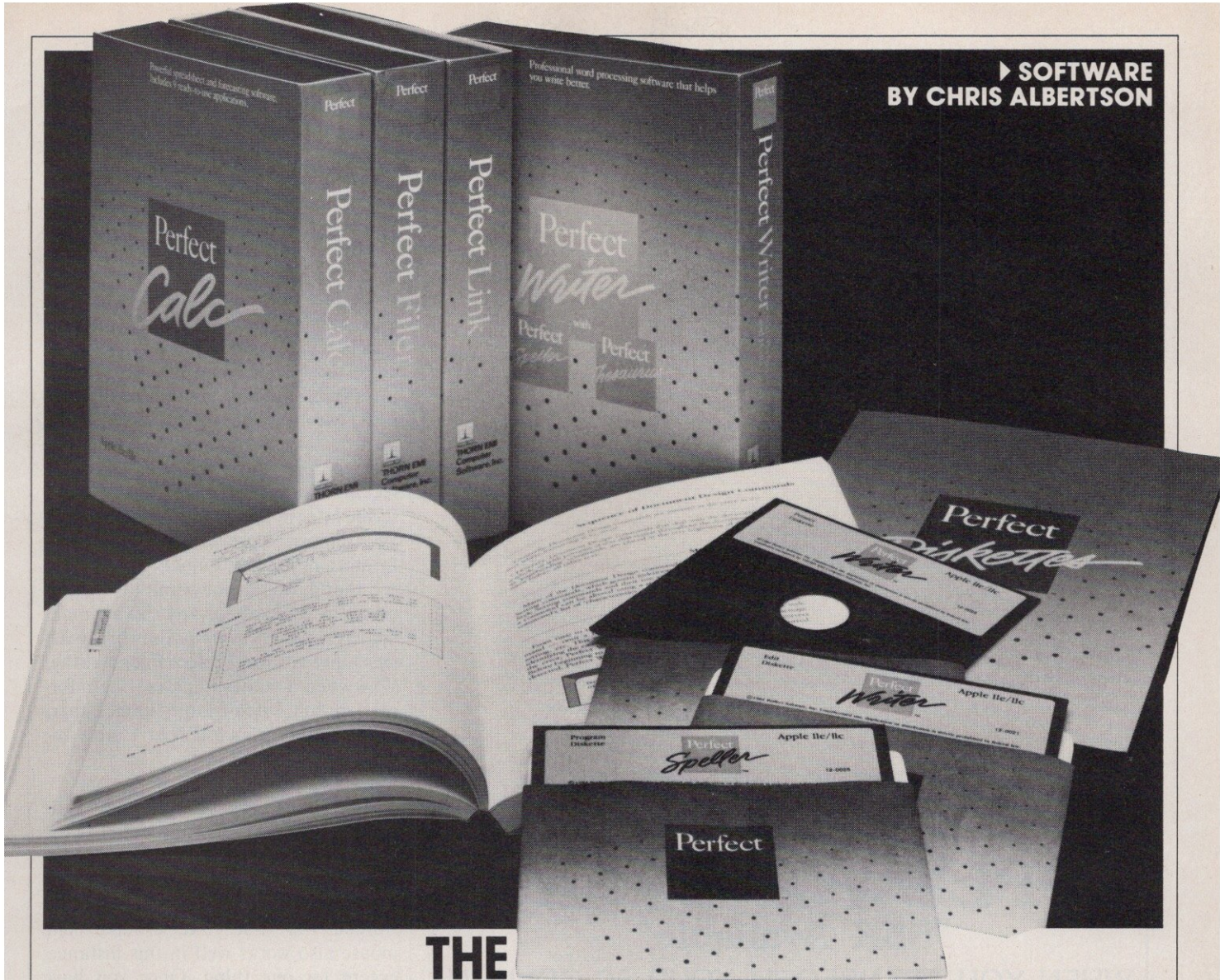

THE PERFECT 2.0 SERIES

IT LOOKS NICE IN
DOS 3.3, BUT IS IT
REALLY PERFECT?

The Perfect Series (Perfect Writer with Perfect Speller and Perfect Thesaurus; Perfect Filer; Perfect Calc; and Perfect Link) has undergone some changes recently. The original version of the series operated under CP/M and made a name for itself by being bundled in with CP/M computer systems (notably Kaypro) as part of the base price of the computer. The idea was that you bought the computer and got the software at no additional cost.

As you may or may not know, the Perfect Series was bought by Thorn EMI, a huge British conglomerate that also makes records, tapes, and films. Thorn EMI then spent a lot of money upgrading the software to work with the Apple native operating system, obviating the need for a CP/M card. During the upgrade process, the Perfect Series programs were revamped to make use of the mouse and pull-down menus. Unfortunately, not enough time was spent on making the series truly perfect.

Perfect Filer

Perfect Filer (PF) is the extremely flexible and efficient database program in the Perfect Series. It actually lives up to the manufacturer's description, in that it requires a minimum of disk swapping, the cursor keeps up with the speediest fingers, and even the mouse is controllable. With the help of PF's well-conceived menus—and a little bit of logic—novice computerists can soon learn to create a database, such as a

mailing list, from which they can extract information for a form letter.

Creating a record form is easy with the program's many prestructured entries, which include Date, Money, Time, Social Security, and Phone formats, as well as Yes/No options. A Record ID format automatically registers incremented values from 00001 to 32767. Name and address entries are also built in.

The time you save by having a stored template available for immediate use is obvious, and if all of the above entries constitute more information than you wish to have in your database, modification is simple. The Escape key produces the Group Entry menu, from which you can select these prestructured data-entry templates. The program then sends them to the screen. Because you can enter other field definitions manually, PF has the kind of structural freedom that PFS programs from Software Publishing Corporation introduced to Apple databases in 1981.

ENTRY NAMES, POSITIONS AND LENGTHS FOR RECORD FORM "CARDLIST" 03/11/85

entry #	row	column	length	name
1	1	12	18	NAME.LASTNAME
2	1	38	18	NAME.FIRSTNAME
3	1	65	15	NAME.MIDDLENAME
4	4	11	35	GREETING.
5	6	15	65	ADDRESS.ORGANIZATION
6	7	15	65	ADDRESS.ADDRESS1
7	8	15	65	ADDRESS.ADDRESS2
8	9	15	21	ADDRESS.CITY
9	9	44	20	ADDRESS.STATE
10	9	70	10	ADDRESS.ZIPCODE
11	10	15	30	ADDRESS.COUNTRY
12	10	52	28	ADDRESS.ATTENTION
13	12	11	3	MARRIED.YESNO
14	12	29	51	SPOUSE.
15	14	12	68	CHILDREN.
16	16	18	3	CURRENT.YESNO
17	16	67	3	PROSPECT.YESNO
18	18	10	70	COMMENT.
19	20	15	8	DATE_ENTER.DATE

SCREEN DEFINITION FOR RECORD FORM "CARDLIST"

.....

Last name: #1 _____ First: #2 _____ Middle: #3 _____

Greeting: #4 _____

Organization: #5 _____

Address: #6 _____

#7 _____

City: #8 _____ State: #9 _____ Zip: #10 _____

Country: #11 _____ Attn: #12 _____

Married: #13 _____ Spouse: #14 _____

Children: #15 _____

Current Client: #16 _____ Prospective Client: #17 _____

Comment: #18 _____

Date Entered: #19 __/__/__

Figure 1: Perfect Filer's structure-display printout is a well-organized, practical reference sheet containing all the information you need to facilitate record entry.

Once you have designed your record structure, PF produces a printout of it, along with a listing of all the entry names, their positions, and the length of each field (see figure 1). The Display Structure command in dBASE II pales by comparison to this feature. You will find this printout to be of immense value when you're composing form letters or simply retrieving data.

Perfect Filer's practical uses are further expandable through the simple way in which it integrates with the other Perfect Series programs. After creating a small mailing-list type of file with PF, I wrote a short form letter, using Perfect Writer, and merged the two files for printing. Unfortunately, Perfect Writer's slow pace (which I describe later in this article), coupled with PF's unhurried process in extracting information, made it quickly apparent to me that I would not want to use this program package for any sizable mailing. Yes, for all of its praiseworthy design and features, Perfect Filer is rather slow when it comes to processing information, but I don't fault the designers of the program as much as I fault the nature of DOS 3.3.

Perfect Calc

The same goes for Perfect Calc (PC), which takes its time but does the job. With the pop-up command menus only a key away, I found myself easily creating "little" spreadsheets that worked the first time around. The mouse also works well in this instance, except for one thing: Once you have used it to pop up a menu (two clicks) and run the selector to the desired line, you had better keep that mouse in the very same spot until you have picked an item (another two clicks). The slightest movement of the mouse sends the menu into limbo and places your cursor in a spot where you would most likely not wish it to be. No wonder Thorn EMI mentions the mouse capability of the Perfect Series only in fine print at the bottom of its magazine ads.

I mentioned that I had created little spreadsheets with PC, but don't take that to mean that the program isn't capable of tackling larger, more involved jobs. It is—if you don't mind a long wait. Much as I like the plain English of the menus and the mere fact that it boasts such features as synchronized windows and a chi-square analysis program, I don't see myself switching the few spreadsheet chores I have to this Perfect Calc.

Perfect Link

I have to say that Perfect Link (PL),

***APPLEWORKS SAYS
"55K Available"**

WHEN YOU TRANSFORM YOUR 80 COLUMN CARD INTO THE "EXTENDED 64K VERSION"

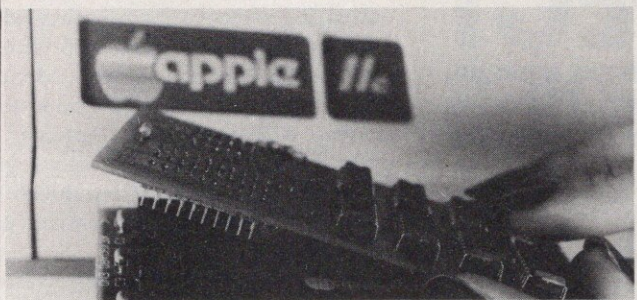

ONE
YEAR
WARRANTY

If you are not satisfied you may return within ten days for a Full Refund. (Shipping not Included)

- Extend 80 plugs into your standard 80 column card to make your Apple //e* a 128K system.
- Extend 80 offers Total Compatibility.
- Extend 80 is a quality, thoroughly tested product.
- Extend 80 sells for just \$129.95 +
- Extend 80 offers double resolution graphics capability.
- Extend 80 can be used while programming under Apple computer's Pro Dots.

*Appleworks and Apple //e are trademarks of Apple Computer, Inc.
+ Add \$3.00 for shipping (\$5.00 outside the U.S. - Payment in U.S. dollars only)

To order send check for \$129.95 + Mastercard Visa Am. Express

CALL TOLL (FL residents add 5% sales tax)

FREE: CARIBBEAN COMPUTER SALES, INC.
1-800-821-0208 221 EAST OSCEOLA - SUITE 210
(OUTSIDE FLORIDA) STUART, FL 33494 (305) 287-3336



**It's easy to make a copy.
It's quick.
It's illegal.
It's wrong.**

It's hard to believe.

People who wouldn't think of shoplifting a software product on their lunch hour don't think twice about going back to the office and making several illegal copies of the same software.

Making unauthorized copies of software is a violation of U.S. Copyright Law. Yet, the problem has reached epidemic proportions because many people are unaware, or simply choose to ignore the law. The software industry is urging decision-makers and software users to take steps to stop software piracy in their organizations. In the meantime, the industry has been forced to prosecute willful copyright violators.

There are legal, moral and economic imperatives forbidding theft of copyrighted software.

There is a free pamphlet on the subject. Call or write for a copy. A copy. A copy. A copy for everyone you know. Please ask for Priscilla.



ADAPSO
1300 North Seventeenth Street
Arlington, Virginia 22209
(703) 522-5055



MAIL ORDER PRICES!



A NEW KIND OF COMPUTER STORE WE DISCOUNT EVERYTHING!

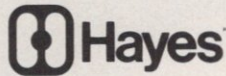

SMARTMODEM 300
SMARTCOM I IIc 149.95
1200 SMARTMODEM..389.95
1200 B (IBM)..... 359.95
MICROMODEM IIe..... 159.95
2400 SMARTMODEM...599.95

FONTRIX:

FONTPAKS 1 THRU 11 EA..... 19.95
FONTRIX (APPLE) 69.95
FONTRIX (IBM) 99.95



ACCELERATOR II+, IIe 219.95
128K RAMCARD APPLE 199.95
III + II CARD (AP III) 299.95
 RUN ALL II+ SOFTWARE ON YOUR III
 INCL. 128K RAM II+ JOYSTICK PORT &
 RAMDISK SOFTWARE

★ **DANA SUPER FAN** 29.95
 FURGE SUPPRESSOR, 2 GR. OUTLETS,
 FRONT SWITCH FOR APPLE II, II+, IIe

APPLEWORKS.....199.95
ASCII PRO IBM..119.95 **AP**..75.95
BANK STREET WRITER IIc...49.95
BANK ST. WRITER II+, IIe...49.95
BANK STREET SPELLER....49.95
BARRON'S SAT AP/IBM.....69.95
COMPUTER PAPER 4.95
COMPUSERVE22.95
COPY II
 (AP, IBM OR MAC) 25.95
CROSSWORD MAGIC.....44.95
DAZZLE DRAW 39.95
D BASE II APPLE.....199.95
DB MASTER IV+ APPLE ...189.95
DISK NOTCHER 12.95
DISKETTE CASE 80-100 12.95
EARLY GAMES AP/IBM.....21.95
EDD III55.95
FLIGHT SIMULATOR II 36.95
FORMAT II99.95
GATO APPLE/IBM27.95
HITCHHIKER'S GUIDE AP/IBM..27.95
HOME ACCOUNTANT MAC...69.95
 APPLE...49.95 **IBM**...89.95
KARATEKA.....26.95
LOCKSMITH 5.0 79.95
MANAGING YOUR MONEY...109.95

APPLE CAT II.....199.95
CH MACH III JOYSTICKS39.95
1/2 HGT DRIVE II+, IIe149.95
1/2 HGT DRIVE IIc.....159.95
KOALA PAD APPLE.....77.95
PADDLE ADAPPLE.....26.95
PROMODEM 1200.....299.95
PROMETHEUS 1200A.....329.95
RF MODULATOR.....24.95
SYSTEM SAVER FAN.....59.95
IIc MOUSE49.95
THUNDERCLOCK109.95

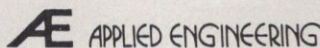

Z-80+.....129.95
TIMEMASTER109.95
RAMWORKS IIe 80 COL CARD
 EXPANDS AN APPLE UP
 TO 1 MEG AND APPLEWORKS
 UP TO 800K..... from 159.95
Z-80 C (CP/M IIc).....139.95
Z-RAM IIc 256K.....349.95
 512K.....419.95

GRAPPLER+.....79.95
BUFFERED
GRAPPLER..... **149.95**

PRINTER SALE

HR 15 XL, 17 CPS.....359.95
EPSON FX 100+.....499.95
EPSON FX 80 FT+349.95
GEMINI SQ 10229.95
OKIDATA 192 (AP, IBM)...359.95
OKI 192 (IIc, LISA, MAC)...439.95
OKIDATA 182.....229.95
PANASONIC 1091.....249.95
C ITOH PROWRITER
 8510 120 CPS299.95
 8510 + 120 CPS NLQ...319.95
SILVER REED #550 L.Q....409.95



ULTRATERM
 40-80-96-132-160 COL

SPECIAL LOW PRICE 179.95

APPLEWORKS II+...39.95
 NEW APPLEWORKS PREBOOT DISK
 REQUIRES 64K & VIDEX 80 COL CARD

16K RAMCARD.....39.95

MICROSOFT.

PREMIUM SOFCARD249.95
MULTIPLAN AP DOS.....69.95
 ALL **MAC CHART**79.95
FOUR MULTIPLAN119.95
PIECES MAC WORD.....119.95
 399.95 **MAC FILE**.....119.95
FLIGHT SIMULATOR34.95
MAC BASIC99.95

— DOLLARS & SENSE —

APPLE II+, IIe69.95
MAC...99.95 **IIc**...79.95
IBM W/FORECAST109.95
FORECAST MAC..59.95 **AP**..49.95



EACH (IBM)79.95
FILE (AP)69.95
GRAPH (AP)69.95
REPORT (AP)69.95
WRITE (IIe, IIc)..69.95

PAK: FILE/REPORT(MAC)...149.95
FILE, REPORT, WRITE,
PLAN IIe/IIc149.95

PRINTSHOP...32.95
PRINT SHOP REFILLS.....11.95
GRAPHICS LIBRARY.....19.95

MAC THE KNIFE I24.95
MATH BLASTER34.95
MEGA WORKS SPELL CHCK & MAIL
 MERGE FOR APPLWRKS...89.95
MIND PROBE AP, IBM.....29.95
NEWSROOM34.95
NORTON UTILITIES 3.0.....69.95
SENSIBLE SPELLER64.95
SIDEWAYS IBM, AP39.95
SOURCE39.95
SPEED READER II.....44.95
SPY VS. SPY24.95

Lotus 1-2-3 PC & PC JR. 95
299
SYMPHONY..409.95

TAKE 144.95
TAX ADVANTAGE (AP, IBM)...44.95
TURBO PASCAL APPLE49.95
TRIVIA FEVER27.95
TYPING TUTOR III AP/IBM...36.95
WIZARDRY IV34.95
WORD JUGGLER.....149.95



BECAUSE HARDWARE AND SOFTWARE
 PRICES ARE CHANGING SO RAPIDLY,
 WE URGE YOU TO CALL FOR OUR VERY
 LOWEST CURRENT PRICES!
 WE APPRECIATE YOUR BUSINESS and will do
 everything we can to make you happy.
TERMS: F.O.B., Westminster, CA. We accept VISA,
 Mastercard, Cash, Money Orders, Checks, Certified
 Checks are better. Purchase Orders (2% 10-Net 15).
 Add 2% for bank cards & P.O.'s. Ask about our return
 policy. Prices are subject to change and hopefully will
 go down. Subject to stock on hand. Unless otherwise
 noted, all prices are Apple.
 Apple is a registered trademark of Apple Computer.

GARDEN OF EDEN COMPUTERS

16485 Magnolia, Westminster, CA 92683
 1/2 Block North of the 405 Freeway

Mon-Fri 10-6:30 Sat 10-5
 CLOSED SUNDAYS & TUESDAYS

800-762-3227

OUTSIDE CALIFORNIA ONLY

8/85 714-841-4994

800-331-0045

INSIDE CALIFORNIA

the communications program, does not take well to the mouse. In fact, just a click of my mouse was enough to freeze PL so solid that it required a reboot. On the positive side is the fact that PL allows you to program keys A through J, a feature that can save on-line time by enabling you to place lengthy commands one keystroke away. Apart from that, however, Perfect Link does not have any features that separate it from the average program of this kind. I have seen equal or better software accompany modems. Not surprisingly, PL's manual is mostly devoted to a description of various time-sharing systems and how to log on to them. In short, this program looks good in a package but fails to impress on its own.

Perfect Writer

Finally, the word-processing program, Perfect Writer (PW), comes in a package of three double-sided (flippy) disks that includes Perfect Speller, a 50,000-word dictionary, and Perfect Thesaurus. The latter should save you time when you need to check for synonyms, but I was soon reaching for the old Roget volume on my bookshelf. Speed—the lack of it—is the DOS 3.3 version's major problem, and the snail's-paced operation is not restricted to the spelling checks. It took 15 seconds to justify a ten-line paragraph, and even a two-finger typist like me can enter a sentence and then look up from the keyboard in time to see the characters appear on the screen.

If an AppleMouse is connected to the computer, all but one of the programs in this series (Perfect Link) will automatically take advantage of it. Just imagine the program keeping up with the pace of a mouse when it had a hard time following my fingers, however. In the case of PW, the pop-up command menus—which give the new Perfect Series an attractive Macintosh look—are overwhelmed by the speed with which the mouse scans their contents. The result is that they often flicker in a most annoying way. Furthermore, I soon abandoned any attempt to move the cursor with the mouse. The mouse simply becomes uncontrollable and tries, with an alarming measure of success, to make your text scroll where no text has scrolled before. Perfect Writer makes the mouse supersensitive: I was entering a filename when my arm accidentally moved the mouse a fraction of an inch, which deleted my entry. Since you cannot disengage the mouse by means of the software, my advice is to move it out of the way.

Another annoyance is a prompt that requests the insertion of the Apple Writer Program Disk. There is no disk bearing that label. I believe the prompt refers to the disk labeled Edit Diskette, but I cannot be absolutely sure, because that disk produced a Swap Write Error message two different times. Rather than store the current work file entirely in RAM, Perfect Writer creates a 32K Swap file on the data disk and moves data back and forth to facilitate editing. This procedure allows the use of files whose length exceeds the comput-

er's RAM capacity, but it also opens the door to trouble. I never got the old Swap File Not Found notice that was part and parcel of the earlier Perfect Writer, but version 2.0 delivered several Swap File Full! and Bad Document Read messages.

Printing a Perfect Writer file is a real chore, for even if you are using two disk drives, you must endlessly swap printer and data disks. The printer-configuration disk offers a menu of about 16 compatible printers, but here again, PW's design is awkward. You

FIND OUT ABOUT IT!

Financial Software from Core Concepts™

WORK FORCE II™ 6 programs on 1 disk.

- 1. THE LOAN ANALYZER:** Compute loan and mortgage amortizations, balloon payments, total interest paid, daily percentage rates, present value of capital leases, and periodic payment amounts. Find an unknown term or the amount which can be financed. Print or display amortizations starting or stopping at any period. Currently used by Banks, CPA's and realstate agents across the country.
- 2. THE SAVINGS ANALYZER:** Compute the future value of savings, IRA's, and investments in moments with The Savings Analyzer.
- 3. THE BALANCING ACT™:** Checkbook balancing is made easy with this once a month checkbook balancing program. Menus allow entries to be added or changed. Group totals, amount of error, and all entries can be printed or displayed.
- 4. THE LINE WRITER™:** A line-at-a-time correctable typewriter. Great for addressing envelopes and other small word processing jobs.
- 5. THE WAGE ANALYZER:** Analyze your income by the hour, time & 1/2, weekly, bi-weekly, semi-monthly and annually. Calculate increases or decreases by amount or percent. Printout provides a great way to present pay raises to employees.
- 6. THE CALCULATOR:** Turns your Apple into a four function printing calculator.

Greg Glau of InCider says: "Borrowing money is no problem with the loan analysis section to guide you. Work Force II is easy to understand and operate. It's an honest value..." June 1984

PROFIT PURSUIT™ 4 programs on 1 disk.

- 1. DEPRECIATION + :** Print or display Straight-Line, Declining Balance, Sum-of-the-Years-Digits depreciations. Plus 3, 5, and 10 year ACRS for personal property, 15 & 18 year ACRS for real estate.
- 2. APR!:** Find the Actual Percentage Rate of loans with prepaid points and fees.
- 3. LEASE MASTER™:** Find lease payment amounts, pre-tax monthly and yearly yield, total yield. Compute with multiple advance payments and residual value. Print or display lease amortizations starting or stopping at any period.
- 4. PRICING MASTER™:** Find the cost, selling price, mark-up, and margin. Recalculate by changing any entry. Print item name and data. A must for retailers & wholesalers!

Compatible with the Apple IIc, IIe, II+, & II

Call Toll Free

ORDERS ONLY

1-800-525-CORE

**ALL ORDERS
SHIPPED
IMMEDIATELY!**

**DEALER INQUIRIES
INVITED**

Apple is a registered trademark
of Apple Computers, Inc.

- Please send me WORK FORCE II at \$39.95 (includes shipping)
 - Please send me PROFIT PURSUIT at \$39.95
 - check or money order VISA MC AE COD (add \$4.00 for COD)
- Arizona residents add 6% Sales Tax. Overseas add \$5.00

Card # _____

Signature _____ Valid From _____ to _____

Name _____ Phone _____

Address _____

City/State/Zip _____



Core Concepts

P.O. Box 24157 Tempe, AZ 85282

AZ residents & inquiries call (602) 968-3756



CIRCLE 236 ON READER SERVICE CARD

CDA

COMPUTER SALES
MAIL ORDER WORLDWIDE
SINCE 1977

AD NO. -1019-8

DUO DRIVE SYSTEM

SYSTEM INCLUDES:

- Apple IIe Computer
- Apple Duo Drive (2 DRIVES)
- SMT Extended 80 Column Card
- Apple Monitor II w/tilt screen
- Apple Drive Controller Card
- PRO DOS
- Epson Spectrum LX-80 Printer
- LX-80 Tractor Feed Option
- Grappler + Printer Card and Cable
- Table top printer stand
- Box of 10 Diskettes
- Package of Computer Paper
- Extra Printer Ribbon
- System Dust Cover
- Printer Dust Cover



LIST PRICE

\$2,319

CDA - \$1839

NEW!

EPSON DX-20 PACKAGE

EPSON PRINTER PACKAGE

- EPSON DX -20 Letter Quality Printer
- Table Top Printer Stand
- Extra Printer Ribbon
- Extra Diablo Print Wheel (Your Choice)

-OPTIONS-AVAILABLE INCLUDE:

- CUT SHEET FEEDER
- ADJUSTABLE TRACTOR

- ★ LETTER QUALITY
- ★ 20 C.P.S.
- ★ 13 INCH CARRIAGE

LIST - \$649

CDA - \$499

★ MONTHLY SPECIALS ★

Extended 80 Column Card
APPLE BRAND!
80 Columns
Extra 64k

List - \$295
CDA \$149

Gamma Drive
IIC Version or
Ile Version

List - \$349
CDA \$239

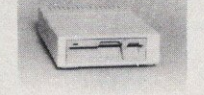

APPLE ACCESSORIES

ALS Smartterm II	\$179	\$129
Apple Mouse IIC	99	87
Apple Mouse Ile	149	134
Applied Eng. 280 IIC	159	119
Applied Eng. RAM Works 128k	249	169
Applied Eng. RAM Works 256k	299	239
MCT Speed Demon	299	239
Micro Sci Ext 80 Col	159	99
SMT Ext 80 Col Card	149	79
Titan Accelerator Ile	319	219

MODEMS

Hayes Micromodem Ile	199	\$159
Hayes Micromodem IIC	239	189
Hayes 2400		
Smartmodem	899	649
Prometheus 1200 A	299	329

PRINTERS

Apple Imagewriter	595	\$479
Brother HR-15	499	369
Brother HR-35	1,245	829
Epson (All Models)	CALL	CALL
Juki 6000	299	239
Okidata (All Models)	CALL	CALL

APPLE DRIVES

Apple IIC Add-On	329	\$279
Micro Sci A-2	299	199
Micro Sci 1/2 Hgt IIC	299	199
Micro Sci 1/2 Hgt	299	199
Quark 10 Meg Hrd Drive	1,999	1,495

*You can also place your order via COMPUSERVES ELECTRONIC MALL 24 Hours a day - 7 days a week.

ORDERING INFORMATION AND TERMS:

Mail to: CDA COMPUTER SALES

31 Marshall Hill Rd., West Milford, NJ 07480

Include address and phone number. Shipping, handling and insurance are additional. Add 2% UPS Ground (\$3.50 minimum) UPS Blue 6% (\$5.00 minimum) NO C.O.D. Cashiers checks, moneyorders and credit cards ship immediately. Personal and company checks allow 15 days.

ORDER 9am-7pm EST Monday - Friday, Saturday 10-4 OUR REFERENCES: We have been selling computers since 1977 and in computer Mail Order since 1980. Our bank is: First Fidelity, West Milford, N.J. D&B listed.

ORDERS ONLY - 800-526-5313

INQUIRIES & IN NJ 201-728-8080

must configure PW to work with one of these printers in one particular mode. In other words, configuring the program for my Okidata ML 92 printer, I was given a choice of draft, 12-pitch, condensed, or correspondence quality. If I want to print a quick draft before going to correspondence quality, I have to prepare one printer disk for each output! Incidentally, having a high-speed printer is no advantage, because PW needs time to "think" before committing each line to paper.

Once it gets going, PW delivers onto paper what it has promised. By the time the printer finally starts moving, though, the frustration of getting started tends to diminish your appreciation of the final results. To be honest, I did not try the indexing and table-of-contents features, because even if they work like a charm, no amount of bells and whistles can make up for the inferior design of this program.

Not Perfect

The manuals are well written, with step-by-step instructions in simple, literate English and a comfortable number of figures and illustrations. The attractive packaging makes the Perfect Series look and read better than it performs, at least with the Apple IIe and IIc versions. Perfect Filer and Perfect Calc are adequate applications. Perfect Link has some nice features but some serious flaws. Perfect Writer is the weakest of these programs. It seems to be suffering from poor design in the earliest stages, and dressing it up with pop-up menus and eye-catching boxes cannot change the situation.

Overall, the Perfect Series is not perfect. Don't look to it to meet all of your computing needs. +

Chris Albertson is a New York music critic who has been using Apple computers since 1979.

▶ PRODUCT INFORMATION

Perfect Series, Version 2.0

Thorn EMI Computer Software
1881 Langley Drive
Irvine, CA 92714
(714) 261-6600

List Price: Perfect Filer, Perfect Calc, and Perfect Writer, \$139 each; Perfect Link, \$109

Requires: Apple IIe with 128K RAM and Extended 80-Column Card, or Apple IIc; one disk drive (two recommended); modem, for Perfect Link

CIRCLE 597 ON READER SERVICE CARD

DMP Utilities

ImageWriter™ Owners

- 24 Character sets to Download to your Imagewriter.
- Font Editor to create custom characters.
- Converts hi-res fonts to work with the ImageWriter.
- Simple to use --- menu driven.
- 60+ page User's Manual.
- Character sets work with any Apple II application program, including AppleWorks, VisiCalc, and AppleWriter.
- Softalk called it "excellent" (Feb 84).
- Creative Computing said it was "a necessity".

Circle the reader's service card and check for yourself how good DMP Utilities are.

Wilberg Bros Computing, Inc.
PO Box 4576, Madison, WI 53711
(608) 274-6433

Apple, Imagewriter, AppleWorks, & AppleWriter are Trademarks of Apple Computer.

VisiCalc is a Trademark of the Visi-Corp.

CIRCLE 244 ON READER SERVICE CARD

INTRODUCING:

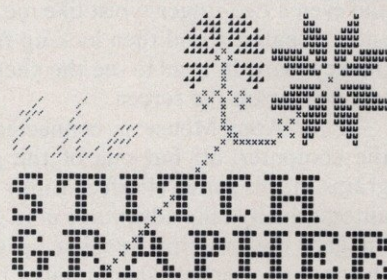

NOW IT IS POSSIBLE

to design your own counted cross stitch and other needlecraft charts using the latest innovative computer technology.

This user friendly program allows you to design projects as large as 240 x 400 stitches with up to 30 symbols and gives you the flexibility to move, copy, mirror image, rotate, erase, save and re-use previous designs.

Utilizing the **APPLE II** series microcomputers, "the **STITCH GRAPHER**" is compatible with most dot matrix printers supporting graphics.

Disk plus informative 75 page manual - **\$89.95.**

Dealer inquiries welcome. For additional information contact

COMPUCRAFTS

RFD 2 Box 216, Lincoln, MA 01775
(617) 259-0409

CIRCLE 157 ON READER SERVICE CARD

CIRCLE 292 ON READER SERVICE CARD

Designed For Those Who Only Accept The Best!

TIMEMASTER II H.O.™

- Absolutely, positively, totally PRO-DOS and DOS 3.3 compatible.
- Time in hours, minutes, seconds and milliseconds (the ONLY PRO-DOS compatible card with millisecond capability).
- 24 hour military format or 12 hour with AM/PM format.
- Date with year, month, day of week and leap year.
- Eight software controlled interrupts so you can run two programs at the same time (many examples are included).
- The only card recognized by both the DOS 3.3 and PRO-DOS versions of Apple Writer IIe.
- Appleworks will now time and date stamp all your data automatically.
- The only clock card that will display the time and date on the Appleworks screen.
- Compatible with ALL of Apple's languages. Many sample programs for machine code, Applesoft, CP/M and Pascal on 2 disks.
- On-board timer lets you time any interval up to 48 days long down to the nearest millisecond.
- Auto-recharging nickle-cadmium battery will last over 20 years.
- Two BSR/serial ports for future expansion.

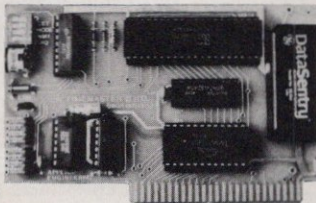

	PRO-DOS COMPATIBLE	INCLUDES DOS DATER	MILLISECOND TIME	YEAR DATA	LARGEST SAMPLE SOFTWARE	REMOTE SET PORT	BSR PORT	EMULATES ALL OTHER CLOCKS
H.O.	YES	YES	YES	YES	YES	YES	YES	YES
BRAND A	NO	NO	YES	NO	NO	NO	NO	NO
BRAND C	NO	NO	NO	NO	NO	NO	NO	NO
BRAND M	NO	NO	NO	NO	NO	NO	NO	NO
BRAND P	YES	YES	NO	YES	NO	NO	NO	NO
BRAND S	NO	NO	NO	NO	NO	NO	NO	NO
BRAND T	YES	NO	NO	NO	NO	NO	YES	NO

Full emulation of all other clocks. Yes, we emulate Brand A, Brand T, Brand P, Brand C, Brand S and Brand M too. It's easy for the H.O. to emulate other clocks, we just drop off features. That's why the H.O. can emulate others, but none of the others emulate us. The Timemaster II H.O. will automatically emulate the correct clock card for the software you're using. Of course most programs will use the Timemaster II H.O. in its native mode, but it's comforting to know that you won't have to worry about compatibility problems. You can also give the H.O. a simple command to tell it which clock to emulate. This is great for writing programs for those poor unfortunates who bought some other clock card.

REMOTE CONTROL

Our BSR X-10 interface option for the H.O. allows you to remotely control up to 16 lights and electrical appliances through your BSR X-10 home control system in your home or office. You're already wired because a BSR system sends its signals over regular 120 volt wiring. That means you can control any electrical device in your home or office without additional wiring.

CLOCK PRICE \$129.00 BSR Option (may be added later) \$49.00

VIEWMASTER 80™

There used to be about a dozen 80 column cards for the Apple. Now there is only ONE.

- TOTALLY Videx Compatible.
- Perfect for any APPLE II, II+ or IIe.
- 80 characters by 24 lines, with a sharp 7x9 dot matrix.
- On-board 40/80 soft video switch with manual 40 column override.
- Fully compatible with ALL Apple languages and software—there are NO exceptions.
- Low power consumption through the use of CMOS devices.
- All connections are made with standard video connections.
- Both upper and lower characters are standard, with true descenders.
- All new design (using a new Microprocessor-based C.R.T. controller) for a beautiful razor sharp display.
- The VIEWMASTER incorporates all the features of all other 80 column cards, plus many new improvements.

	PRICE	BUILT-IN SOFTSWITCH	LOW POWER DESIGN	80 COLUMN HOME	7X9 DOT MATRIX	LIGHT PEN INPUTS	40 COLUMN OVERRIDE	INVERSE CHARACTERS
VIEWMASTER 139	MORE	YES	YES	YES	YES	YES	YES	YES
SUPRTERM	MORE	NO	NO	NO	NO	NO	YES	YES
WIZARD 80	MORE	NO	NO	NO	YES	NO	YES	YES
VISION 80	MORE	YES	NO	NO	YES	NO	NO	NO
OMNIVISION	MORE	NO	NO	NO	NO	NO	YES	YES
VIEWMAX 80	MORE	YES	NO	NO	YES	NO	NO	YES
SMARTERM	MORE	YES	NO	NO	NO	YES	YES	NO
VIDEOTERM	MORE	NO	YES	NO	YES	YES	NO	YES

The VIEWMASTER 80 works with all 80 column applications including CP/M, Pascal, WordStar, Format II, Easywriter, Apple Writer II, VisiCalc, Dollars and Sense, and all others. The VIEWMASTER 80 is THE MOST compatible 80 column card you can buy at ANY price!

PRICE \$139.00

Z-80 PLUS™

Now Includes New 4.0™ Software

Enter the CP/M world with the new Z-80 Plus card from Applied Engineering and introduce your Apple to thousands of new programs. Only the Z-80 Plus comes standard with the new 4.0 software, the most advanced system for running CP/M programs ever. Only CP/AM 4.0™ has advanced features like built-in disk emulation for popular memory expansion boards (those made by Apple and Applied Engineering and others) to give you a faster system with more storage. You also get menu driven utilities that are much easier to use than the older CP/M utilities so you can get down to all that great CP/M software faster. The Z-80 Plus runs older CP/M programs too, down to Version 1.6 (2.2 is the most popular). With the Z-80 Plus you can run the largest body of software in existence, and the Z-80+ is the only card on the market capable of accessing more than 64K in an Apple IIe. If you have an extended 80 column card, all 128K is usable, and if you have Ramworks, up to 1088K is available to CP/M. And each Z-80+ includes our CP/M Ram Drive software, enabling IIe owners to use an extended 80 column card, or a Ramworks card as an ultra-fast Ram disk enabling CP/M software to run 10 to 20 times faster. So fast acting software like WordStar, and dBASE II become virtually instantaneous! Simply plug the Z-80 Plus into any slot in your Apple. You'll have two computers in one and the advantages of both, all at an unbelievably low price.

- TOTALLY compatible with ALL CP/M software.
- Fully compatible with most hard disks including the Sider and Corvus.
- The only Z-80 card with a special 2K "CP/M detector" chip.
- Fully compatible with microsoft disks (no pre-boot required).
- Specifically designed for high speed operation in the Apple IIe (runs just as fast in the II+ and Franklin).
- Runs WordStar, dBASE II, Turbo Pascal, Fortran-80, Peachtree and ALL other CP/M software with no pre-boot.
- A semi-custom I.C. and low parts count allows the Z-80 Plus to fly through CP/M programs at a very low power level. (We use the Z-80B at a fast 4MHZ.)
- Does EVERYTHING the other Z-80 boards do, plus Z-80 interrupts.

PRICE \$139.00

Our boards are far superior to most of the consumer electronics made today. All I.C.'s are in high quality sockets with mil-spec. components used throughout. P.C. boards are glass-epoxy with gold contacts. Made in America to be the best in the world. All products work in Apple IIe, II, II+ and Franklin. Applied Engineering also manufactures a full line of data acquisition and control products for the Apple; A/D converters and digital I/O cards, etc. Please call for more information. All our products are fully tested with complete documentation and available for immediate delivery. All products are guaranteed with a no hassle **THREE YEAR WARRANTY.**

Call (214) 241-6060, 9 a.m. to 11 p.m. 7 days a week or send check or money order to

P.O. Box 798, Carrollton, Texas 75006. MasterCard, Visa and C.O.D. welcome. No extra charge for credit cards. Texas residents add 5% sales tax. Add \$10.00 if outside U.S.A.

AE
APPLIED ENGINEERING
"We Set the Standard!"

Beagle Bros Apple Software Report

Call 619-296-6400 or write for free Catalog

Ad Number 222—Page 1

"All the News That Fits"

Summer 1985

NEW! ProDOS Disk with Tip Book! PRO-BYTER™

\$34.95 (Compatible with any Apple IIe, IIc or 64K II+ / ProDOS™)

ALL-NEW—BYTEZAP PRO

Inspect ProDOS™ and DOS 3.3 disks at the byte level. Make changes, improvements and disk or program repairs that are normally impossible. An *all-new* program with instantaneous block-to-block (or sector-to-sector) viewing.



Pro-Byter has given me new VIM and VIGOR!

DISK SEARCH: Find any word or phrase on a disk. Automatically trace or search any file. Repair "zapped" disk bytes that might cause malfunction. Instant disk maps show which sectors or blocks any file occupies.

CUSTOMIZE DISKS: Easy instructions show how to make changes to disks, other programmers' programs, and DOS itself—a changed byte here and there can produce amazing results. Hey, this stuff is FUN!

NEW ProDOS UTILITIES

MACHINE LANGUAGE SORT: One CALL in your Applesoft program will alphabetize a list of words or numbers—*super-fast!* Works with normal string-arrays (A\$(1), A\$(2), etc.).

CONVERTER: Convert any Applesoft program line into machine code that can be CALLED by any Basic program.

TEXT TYPER: Read and print ProDOS text files (on your screen or printer) without having to boot another disk.

MORE: Put time and date of save in your disk catalogs. Print alphabetized lists of your ProDOS catalogs (including all hidden subdirectories). Make any Applesoft command work like any other. Scramble Basic so only you can read it...

MACHINE LANGUAGE EDITOR

If you type in machine language programs from magazines, you'll love being able to make corrections by inserting and deleting code (no machine language knowledge required).

This easy-to-use editor also serves as a neat two-way-scrolling memory scanner. (Find out what's *really* going on inside your Apple's head.) The Pro-Byter manual shows you where in memory to look to find some very interesting stuff.

PLUS ALL-NEW APPLE TIPS

From the authors of DOS BOSS (Bert Kersey and Jack Cassidy)—page-after-page of juicy tips, experiments and inside info about your Apple. Learn secrets about Apple's new ProDOS operating system and Apple disk structure.

The latest official version of ProDOS (V1.1.1 with the new "Bye" command) is included on the Pro-Byter disk.

Beagle Bros
Apple®
Tip Book #8

You get a GOLD MINE of tips, including: How to use memory like an extra disk drive (ProDOS lets you load & save files in RAM), How to disable the LIST command so it says "File Locked", How to disable or swap ANY command, How to change "Startup" to any name, How to personalize ProDOS catalogs...

POKE 800,185: POKE 801,208:
POKE 802,208: POKE 803,9:
POKE 804,128: POKE 805,32:
POKE 806,237: POKE 807,253:
POKE 808,200: POKE 809,76:
POKE 810,32: POKE 811,3:
CALL 800

THAT'S EASY FOR YOU TO SAY.

UTILITY CITY™

\$29.50 (Compatible with any version of Apple II / DOS 3.3)

A-Plus Magazine Readers' Choice
1985 Product of The Year

21 USEFUL UTILITIES: *List-formatter* puts each statement on a new line with indented loops and printer page breaks. *Multi-Cat* lets you create multi-column catalog printouts. *Filename Zap* allows invisible and trick file names, etc. Utility City is for beginning as well as advanced Applesoft programmers—very educational.

SILICON SALAD™

\$24.95 (Compatible with any version of Apple II / DOS 3.3)

OVER 100 PROGRAMS!

Program Splitter makes room for hi-res graphics in big programs. *Disk Scanner* finds bad sectors. *DOS-Killer* adds 2 disk tracks of disk space. *2-Track Cat* doubles the number of files. *Text Imprinter* converts text screen text to hi-res...

NEW! 128K Extended Memory Utility! EXTRA K™

\$39.95 (Compatible with any Apple IIc or 128K IIe / DOS 3.3 and ProDOS™)

PUT YOUR 128K TO WORK!

Even with 128K of memory, your Applesoft programs, pictures and variables only occupy and access the lower 48K. The EXTRA K disk contains several powerful programs that let you utilize *all* of that 128K capacity, speed and muscle.

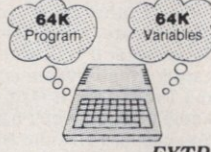

EXTRA VARIABLES

Your Applesoft programs can now function undisturbed in main memory while all variables, strings and other data reside in your Apple's massive extra 64K. Everything functions normally—no special commands or procedures required.

EXTRA APPLE

EXTRA K lets you have two 64K Apples and programs in memory at once and switch between them at will. Plus, you can even have a ProDOS™Apple and a DOS 3.3 Apple in memory simultaneously and swap files back and forth without subjecting yourself to Apple's *Convert* program.

EXTRA-FAST COPIES

Make disk copies fast and "on-the-spot" without re-booting! EXTRA K's "nibble copier" duplicates and verifies unprotected disks in 35 SECONDS instead of 1½ minutes. Thanks to your Apple's 128K, only 3-4 passes per disk are necessary.

EXTRA FEATURES

Compare any two disks, byte-for-byte. Create "dual personality" ProDOS/3.3 disks. Peek and poke auxiliary memory. Keep a live "logbook" of everything that has appeared on your text screen and review it when you want...

EXTRA SCREENS

Store all kinds of images in memory and display any one (all or part) instantly. Up to 7 hi-res pictures or 62 text screens can be stored at once. Call several pictures to the screen per second, opening up new Apple animation possibilities.



EXTRA K allows high-speed multi-screen switching.

DOS BOSS™

\$24.00 (Compatible with any version of Apple II / DOS 3.3)

CUSTOMIZE DOS 3.3

Change *Catalog* command to *Cat*, or "Syntax Error" to "Oops!", or anything you want. *Protect your programs:* An unauthorized Save-attempt can print "Not Copyable". *List Prevention*, other useful tips and fascinating experiments. *DOS Boss* will teach you a ton about Apple programming!

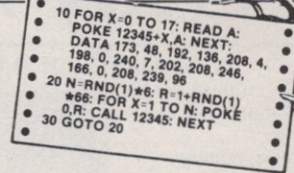
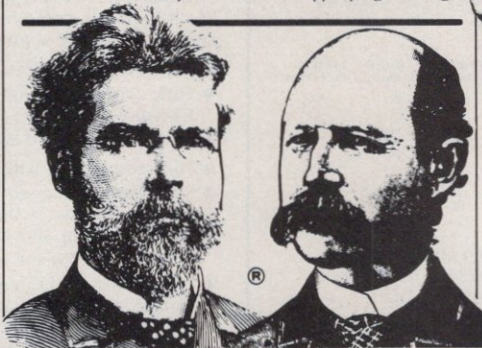

New Applesoft Compactor / De-Bugger!

D CODE™

\$39.95 (Compatible with any version of Apple II / DOS 3.3 and ProDOS™)

PROGRAM PACKER

D CODE squeezes all of the wasted and unused bytes out of your Applesoft programs, saving valuable memory space and increasing your programs' speed and efficiency.

Automatically combine program lines, shorten variable names and/or remove REMarks. D CODE also uncovers wasted program lines that can't possibly be executed.

AUTO-PROOFREADER

Keyboard errors are caught as you type. If you enter an illegal program line, you are told immediately—*before* you (or worse—someone else) runs your program. Or you may simply type "CHECK" to scan an *entire* program in a couple of seconds and uncover potential crashes. If no mistakes are found, you get an immediate "NO ERRORS" message.

SUPER-TRACE

When a program stops or crashes, type "DUMP" to see the last 10-10,000 statements and line numbers that were executed, in the order executed—an instant program *history*.

D CODE features sophisticated "live" tracing too, with each executing statement, line number and selected variable values appearing in a window at the bottom of the screen:

Your program runs up here.

Lines & VARIABLES traced down here.

BREAKPOINTS

D CODE lets you set up de-bugging "breakpoints" so your program stops when you want. For example, you can ask that your program be stopped the moment X gets set to 99, or the 3rd time a particular program statement is encountered.

LIGHTNING-FAST FIND!

D CODE lets you find strings and variables *fast*—even large programs can be searched in about 2 seconds! All lines with a specified word are automatically listed with the word highlighted. This feature alone is worth the price of D CODE.

GPLE COMPATIBLE

D CODE remains "transparent" to your programs and is fully-compatible with GPLE, Double-Take, ProntoDOS, etc.



START OF PROGRAM POINTER

1 HOME: HTAB 5: POKE 33,28: FOR C=1 TO 92: POKE 50,255-192* (C-4 OR C=64)
9 J=J+1-31*(J=31): PRINT CHR\$(9+(J=1)): SPC(2+(J<10))J: NEXT: PRINT
85 POKE 33,1: PRINT "JULY..AUG..SEPT...."

Beagle GAMES

I. O. SILVER™

\$29.95 (Compatible with any version of Apple II)

HI-RES STRATEGY!

I. O. SILVER is *both* a thinking person's strategy game and a fast-action arcade game. Your job is to create a hi-res "Super Computer" on the screen while avoiding a pesty gang of computer bugs. I. O. Silver's Strategy Workshop lets you plan your moves before each level. Excellent high-speed animation and hi-res action. Great for ages 12 & up.

SOURCE CODE: Programmers can get fully commented I. O. Silver Source Code on three 2-sided disks for \$30. Ordering info comes with the game.

BEAGLE BAG™

\$29.50 (Compatible with any version of Apple II)

12 GREAT BASIC GAMES

Voted by Apple software buyers to *Softalk's* "Top-30 Most Popular" list, Beagle Bag is one of the best Apple game bargains on the market today. All games are LIST-able, so you can see what makes them work, or make changes.

Beagle Bros MICRO SOFTWARE

The Apple Programmer's Best Friend

BEAGLE BROS, INC.

3990 OLD TOWN AVENUE, SUITE 102C
SAN DIEGO, CA 92110 PHONE 619-296-6400

Beagle Bros Apple Software Revue

Ad Number 222—Page 2

"All the News That Fits"

Public Notice



Beagle Bros products are available at most Apple software stores. If your favorite dealer doesn't have a particular disk, get on his case. He can have it in his store for you in 2 or 3 days by phoning Beagle Bros or any U.S. Apple Software Distributor.

er 1985

Print Pictures on Your Printer!

TRIPLE-DUMP™

\$39.95 (Compatible with any version of Apple II/ DOS 3.3 and ProDOS™)

PRINT ANY APPLE IMAGE

TRIPLE-DUMP lets your dot matrix graphics-capable printer print (1) Hi-Res and Double Hi-Res graphics. (2) Lo-Res and Double Lo-Res graphics. (3) Forty and 80-Column text screen text.

All kinds of images can be transferred to your printer with absolutely no programming knowledge. Or you can call Triple-Dump's routines from your own Applesoft Basic programs.

TRIPLE-DUMP gives you a full range of special effects—crop, rotate, magnify, compress, adjust density, etc.

GIANT BANNERS TOO

Print big signs and messages of all kinds (with 8½" high letters) on any kind of dot-matrix or letter-quality printer.



GIANT BANNERS

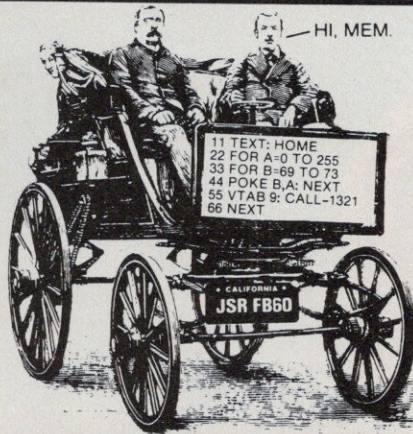

FATCAT™

\$34.95 (Compatible with any version of Apple II/ DOS 3.3 and ProDOS™)

APPLE-DISK LIBRARIAN

Organize your disk library! FATCAT enters all of your ProDOS and 3.3 disk catalogs into one or more "Master Catalog" for fast searching, sorting and printing. Find the files you're looking for and eliminate space-wasting duplicates.

You can update your Master Catalog at any time by simply letting FATCAT read in your new or altered disks.

ALPHABETIZE FILE NAMES

FATCAT will sort your ProDOS and 3.3 disks so they catalog in alphabetical order. Or you can re-arrange file names in any order. Compare any two files too, and find the differences.

DISKQUIK™

\$29.50 (Compatible with Apple IIc or 128K IIe/ DOS 3.3)

DOS 3.3 IN-MEMORY DISK DRIVE!

DISKQUIK makes your Apple IIc or 128K IIe think it has an extra drive connected to Slot 3. It's just like using a super-fast (hard-disk speed), silent drive. Catalog with a "CATALOG,S3" command. Save and load all kinds of files to and from RAM with normal commands (holds about half the data of a floppy).

MANY USES: For example, load often-used programs into memory when you boot, so they are ready to use.

PRONTO-DOS™

\$29.50 (Compatible with any version of Apple II/ DOS 3.3)

TRIPLE-SPEED DOS 3.3!

ProntoDOS lets you load & save files at triple speed. Hi-res pix, for example, load in under 3 seconds.

MORE RAM & DISK SPACE

Create high-speed bootable disks with 15 extra sectors of space. Move DOS 3.3 to your Language Card (64K reqd.) for an extra 10K of usable memory. Also: Pronto's new TYPE command instantly displays DOS 3.3 text file contents.

Hi-Res Shapes and Fancy Type!

APPLE MECHANIC™

\$29.50 (Compatible with any version of Apple II/ DOS 3.3)

HI-RES SHAPE ANIMATION

Your drawings are converted into hi-res "shape tables" so your programs can perform animation with Apple's built-in DRAW & XDRAW commands. List and Learn disk demos teach you how to create your own animated hi-res programs.

"Use Apple Mechanic routines & fonts in your programs without fear!"



"Just credit Beagle Bros on your disk and manual!"

FANCY DISPLAY TYPE

Six proportionally-spaced hi-res screen-display fonts (both large and small) are included on the Apple Mechanic disk—

WESTERN: KLMN
apple: ABCDEFG
STENCIL: ABCDE

26 more typefaces are available on our Apple Mechanic Typefaces™ disk (sold separately: \$20.00).

16-COLOR DOUBLE HI-RES GRAPHICS!

BEAGLE GRAPHICS™

\$59.95 (Compatible with Apple IIc or 128K IIe/ DOS 3.3 and ProDOS™)

DOUBLE HI-RES

Access 16 hi-res colors and 560 (horiz.) x 192 (vert.) pixels (twice normal resolution) on your Apple IIc or 128K IIe.

AS AN ARTIST, you can draw, fill and label double hi-res pictures using just the keyboard, or your AppleMouse™, joystick, Koala Pad™ or Graphics Tablet. Easy-to-use icon-assisted Cut & Paste features make graphic manipulations easy. Any image section may be altered or re-located.

OR, AS A PROGRAMMER, you get 33 new commands for drawing, filling and manipulating double-res images. You can convert normal programs and pictures to double-res, save and load any image section, compress picture data to 1/3 disk space, produce double-res "slide shows" and more. EXCELLENT REVIEWS—see Jan-85 A-Plus Magazine.

BEAGLE BASIC™

\$34.95 (Compatible with unenhanced Apple IIc or 64K II+/ DOS 3.3)

BETTER APPLE BASIC

Put Applesoft in RAM so you can change and improve it. Add new commands to Basic, like ELSE, SWAP, TONE...

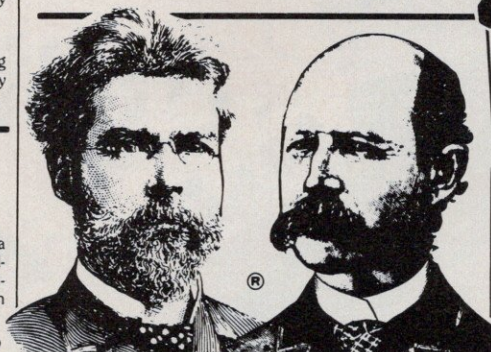

Beagle Bros

MICRO SOFTWARE

The Apple Programmer's Best Friend

BEAGLE BROS, INC.

3990 OLD TOWN AVENUE, SUITE 102C
SAN DIEGO, CA 92110 PHONE 619-296-6400

APPLE™

\$49.95 (Compatible with any version of Apple II/ DOS 3.3 and ProDOS™)

THE APPLE PROGRAM EDITOR

APPLE is Beagle Bros' "GLOBAL PROGRAM LINE EDITOR", the most popular, efficient way to edit Applesoft programs. APPLE works like a word processor for Basic program lines.

INSERT & DELETE

Now you can quickly make changes to your programs. No more awkward "escape-editing" to make changes. No more hassles with extra spaces in quote statements. No more slow "cursor-tracing" to the end of a line before pressing Return.

SEARCH & REPLACE

Find every occurrence of a string or variable in your programs. Or replace any word with any other. For example, change all X's to ABC's, or all "HORSE" strings to "COW".

FUNCTION KEYS

Define your own Apple "function keys". For example, ESC-1 can Catalog drive 1, ESC-N can clear the screen and type your name and address, etc. Customize your Apple with a set of ESC functions that perform any set of tasks that you want.

DOUBLE-TAKE™

\$34.95 (Compatible with any version of Apple II/ DOS 3.3 and ProDOS™)

2-WAY SCROLLING

Listings and disk Catalogs scroll both up and down, making file names and program lines easier and faster to find. You change scroll-direction with the Arrow keys. Machine language listings and Hex-Ascii dumps scroll two-ways too.

BETTER LIST FORMAT

Double-Take's easy-to-read listings have each Applesoft program statement on a new line for fast program reading.

BONUS FEATURES

A\$="ABC" ← VARIABLE-DISPLAY: Instantly prints X=3.14159 all of your program's variables in the Y=255 order used, with their current values.
A\$: 5 10 150 ← CROSS-REFERENCE: Alphabetizes X: 10 20 3000 every variable your program uses, and Y: 5 40 55 60 displays them with their line numbers.
Plus AUTO-LINE-NUMBER, improved Re-Number, Hex-Dec Convert, Program Stats, eliminate /re-define the cursor...

Visa/MasterCard or COD, order Toll Free
ALL 50 STATES, 24 HOURS (orders only)
1-800-227-3800 ext. 1607

Beagle Bros products are on the shelves at your local Apple Software Store.

- We also ship FAST via First Class Mail:
- Alpha Plot . . . \$39.50
 - Apple Mechanic . . . 29.50
 - A.Mech.Typefaces . . . 20.00
 - Beagle Bag . . . 29.50
 - Beagle Basic . . . 34.95
 - Beagle Graphics . . . 59.95
 - D Code . . . 29.50
 - DiskQuik . . . 24.00
 - DOS Boss . . . 24.00
 - Double-Take . . . 34.95
 - Extra K . . . 39.95
 - Fatcat . . . \$34.95
 - Flex Type . . . 29.50
 - Frame-Up . . . 29.50
 - GPLE . . . 49.95
 - I. O. Silver . . . 29.95
 - Pro-Byter . . . 34.95
 - ProntoDOS . . . 29.50
 - Silicon Salad . . . 24.95
 - Tip Disk#1 . . . 20.00
 - Triple-Dump . . . 39.95
 - Utility City . . . 29.50
- ADD \$1.50 FIRST CLASS SHIPPING (ANY SIZE ORDER).
COD add \$3.00/California add 6%/Overseas add \$4.00

NAME _____
ADDRESS _____
ZIP _____
VISA/MCARD# _____
EXPIRATION DATE _____



MAIL DIRECTLY TO BEAGLE BROS.
WE PROCESS ALL ORDERS IMMEDIATELY.

© 1985, Beagle Bros, Inc.

CIRCLE 249 ON READER SERVICE CARD

ADRIAN DAY



THE CHALLENGE:
TO UNEARTH SOME COMPUTER
RELICS
**IN SEARCH
OF
EARLY APPLES**

You may not be Indiana Jones, but you can still be a Raider of Lost Apples.

You see, the personal-computer industry hasn't even reached its teens, but it's still old enough to have amassed books and articles chock-full of memorabilia, as well as its fair share of historical artifacts.

For Apple Computer, Inc., which, more than any other company, has brought computers to the public, those artifacts are the original Apple computers. And those first Apples lie buried in the closets or on the computer desks of you readers, beyond the ken of mere magazine editors.

We attempted what we thought was a simple experiment a couple of months back: We thought we'd locate the first ten Apple I or Apple II computers. At first we assumed the task would be easy, perhaps requiring a few phone calls. But the project quickly mushroomed into a full-scale archaeological dig, as we found ourselves burrowing through layers of old sales receipts and computer stores' ancient history, sifting for chips and shards of the past.

What we've come up with so far are scattered pieces of the puzzle, a few of the stories behind those first purchases. Before you dig for your own serial number underneath the stack of software, let us fill you in on what we've already discovered.

Probing the Strata

The top layer comprised the first distributors and retailers who sold Apple machines to hobbyists.

Number 12 has been retired after years of yeoman service to John Simonton in Oklahoma City, Oklahoma, who purchased it when he and Charles

Weddington were wholesale computer-parts distributors back in 1976. "We started our store to get computer gear at a lower price," jokes Simonton.

Weddington, now president of Hi-Technology Software Products, remembers that the early machines had thicker, less-finished cases without air vents on the sides and rear, "because they were trying to ship just the product."

Simonton extracted number 12 from their first shipment of Apple IIs shortly after it came in, because of its low serial number. The rest of the machines went on to retailers such as the Compu-Shop store in Texas.

► **We were not looking at it and thinking 'This is going to be history.' We were saying, 'I hope we make money.'**

Simonton eventually formed his own company, Paia Electronics, manufacturers of electronic music kits. Until about six months ago he was still using old number 12 as a software-development system, with the Paia board as the target system.

Warren Winger, owner of Compu-Shop, didn't do badly in his distribution agreement with Simonton and Weddington. Winger, owner of what is now a 53-store, 13-state chain based in Dallas, says he owns Apple II number 11. His company bought that machine back from its original owner, one Cid Newberry of Garland, Texas.

"We found the sales ticket, got a hold of him, and traded him an Apple III for it," says Winger.

Winger had sold that first Apple II, the only one the store sold that month, on July 16, 1977—he keeps the machine and sales ticket safely in his closet. He recalls that the documentation was "ten mimeographed pages. There was zero software for it, no interfaces, just a prototyping card for hobbyists."

That first buyer, a true hobbyist, couldn't bring himself to buy the machine until he saw it actually accomplish something.

He and Winger tinkered with the machine for hours trying to bring up its reputed color graphics. Garland's abashed wife eventually took Winger aside and assured him, "I hope you'll forgive my husband; he really does want to buy the machine. He just wants to see it do something."

As soon as a few color dots appeared, Garland plunked his money down. The retail cost for this barebones 16K computer with no interfaces, no cassette recorder, no disk drive—no nothing—was (in case you've forgotten) \$1678 plus tax.

"That's when happy, sleepless nights were the nature of the business," Winger reminisces. He recalls selling an 8K memory board for \$225 at around the same time. "We don't even have chips as small as 8K anymore," he laughs.

Museum Treasures

One Apple I has found a home in the Computer Museum in Boston, Massachusetts. This particular relic rests beside other personal-computer ancestors, such as the Altair and the Xerox Alto. Early Apple staffers say that Apple I

serial numbers began in the 8000-100s (and only about 210 of the machines were made); this machine's number is 8000-10.

Another ancestral Apple found a home in a museum, eventually. Steve Headley, computer-science instructor at Homestead High School in Cupertino, California, allows that one of his former students surreptitiously donated to the school a special Apple II, one that "came from parts and pieces put together by someone who worked for Apple." Headley adds that about three years ago, Steve Jobs traded the serial-numberless board for an Apple II Plus. The errant Apple now rests in the Smithsonian Institution in Washington, D.C.

Who was this mystery student? "Oh, that was Woz," says Randy Wigginton, who, as Apple's first programmer, ought to know. Wigginton has known Steve Wozniak since Woz gave him rides home from the Homebrew Computer Club, "till I was old enough to drive."

Says Wigginton, "That machine at Homestead was a board that didn't pass the original tests when they were trying to design a PC board. Woz fixed

the wiring by hand and put spare parts on it, so it doesn't have a serial number or anything. It didn't go out through production."

Wigginton revealed the reason Apple's records on its early machines were sketchy: "There were none.

"When you don't have any money, you don't have a large records department where you write down everything that's going on. We were not looking at it and thinking, 'This is going to be history,' and being very careful about ev-

▶ Hans Arenz received his Apple II, serial number 000001, out of the back of a pickup truck.

everything. We were saying, 'I hope we make money.' Nobody bothered writing anything down."

Wigginton would have had one of the first Apple I computers himself, but he says that when he tried to build it, he never got it to work. "But that was my first-ever electronics project."

We contacted the person who

seemed most likely to know the whereabouts of early Apples, at the office of his new company in Los Gatos, California. A cacophony of voices surrounded Steve Wozniak as he recalled the disposition of the original Apple machines: "Well, the first run of IIs went to the Homebrew Computer Club. One of the first of that group went to Randy Wigginton, and others of those went to Homebrew members. The first official orders from a demo went as PC boards to engineers at Hughes Corporation in Los Angeles. The II didn't have a strong presence in the first orders, though."

As for the Apple I, he said, "The first Apple I is the board I have. The second, Randy Wigginton had. The rest of the first few were raw PC boards I was trying out." One board may have gone to a man back East who planned to develop a music card for the Apple.

The best story of all comes from the ex-owner of the very first mass-marketed Apple II. Hans Arenz, who was 14 years old at the time, received his Apple II, serial number 000001, out of the back of a pickup truck parked at a cloverleaf near Silicon Valley.

"My father and godfather worked

Portable Power for the Apple IIc

Prairie Power™ has a great new 8-hour power system* and carrying case for the Apple IIc and its flat-panel LCD screen. Now Prairie Power and your IIc can hit the road.

The heart of Prairie Power is the rechargeable battery pack and four-function charger that keeps your mind on your work and not the battery. At home, Prairie Power continues to work as a total battery backup system.

The handsome yet rugged water-resistant case is fully padded, has internal support panels and a separate removable pack for battery and charger.



*Total system contains battery pack, transformer, diskette & screen pouch, shoulder strap, cables and removable PVC panel for lap-top computing. System will also support new C-VUE screen by SWI. Total system.. 20 lbs.

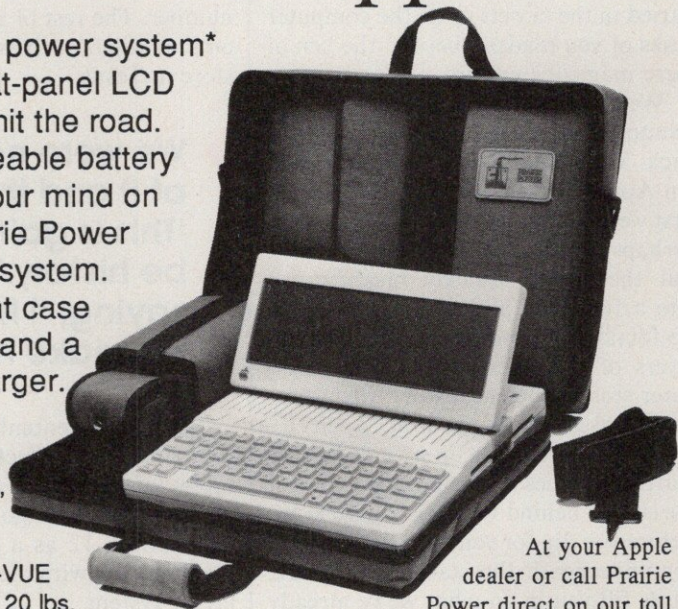

At your Apple dealer or call Prairie Power direct on our toll free number (8am to 5 pm CDT)

1-800-435-8721

Retail price is \$249.95

Freight Extra

Visa & Master Card accepted

The Symbol For Portable Power

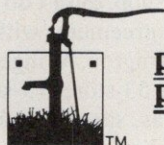

**PRAIRIE
POWER**
SYSTEMS, INC.

Prairie Power Systems, Inc. Box 334 Wayzata, Mn 55391

CIRCLE 302 ON READER SERVICE CARD

C·VUE™ Flat Panel Display

**Portable, lightweight,
attachable, adjustable
flat panel display
system for the
Apple IIc Computer.**



C·VUE Flat Panel Display \$525.00

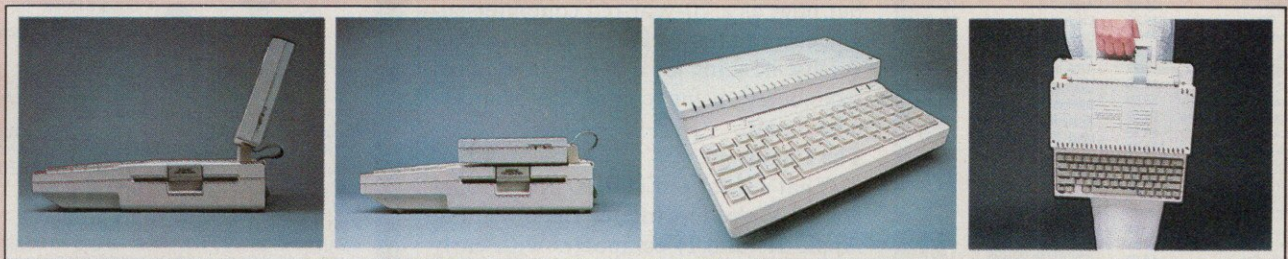

C·VUE FEATURES:

- Full 80 character by 24 line display, including graphics.
- Display panel adjust to any viewing angle.
- Contrast adjustment control.
- Display panel folds down on top of the Apple IIc Computer.
- C·VUE display and Apple IIc easily fit into the Apple IIc carrying case.
- C·VUE display system is easily attached or removed from the Apple IIc.
- C·VUE offers excellent contrast and greater viewing area.
- C·VUE is a product of SWI International System Inc.

To order your C·VUE Flat Panel Display System for the Apple IIc call Thunderbird Instruments. 1-800-821-1989 Ext. 456.

All orders are shipped UPS C.O.D. unless payment is made by VISA or MasterCard. Add 2% for shipping and handling. Purchase orders will be accepted subject to credit approval. Arizona residents add sales tax of 6%.

Canadian Orders: Price is subject to currency fluctuations. Call for price.

International Orders: All orders placed for delivery outside the Continental United States must be pre-paid by certified check only. Add 3% for shipping and handling.

Educational Discounts are available to qualified educational institutions. VISA and MasterCard accepted.

Apple IIc is a registered trademark of Apple Computer Inc.
C·VUE is a trademark of SWI International System Inc.

NEC PRINTERS. THEY ONLY STOP WHEN YOU WANT THEM TO.



Color Pinwriter CP2
dot matrix printer.



Spinwriter 8800
letter-quality printer.



Pinwriter P3
dot matrix printer.

NEC printers are incredibly reliable.

In fact, with normal use, an NEC printer can run an average of 5 years before it needs a repair. And chances are, that repair will take only about 15 minutes.

To become that reliable, an NEC printer has to go through some of the most demanding tests in the industry.

First, we test every single part before it goes into the printer. Then we test the printer itself. Nothing is forgotten. Nothing is left to chance.

But reliability is only part of the story. There's much more. Our printers work with every popular PC. With more leading software programs. And with more forms handlers to make paperwork a snap.

So no matter what your printing needs—and no matter what size your budget—NEC has a printer for you. Our full line of Spinwriter® printers, for low to high speed letter quality printing. And our versatile Pinwriter™ and Color Pinwriter printers, for high resolution dot matrix printing.

To find out more about NEC printers, call 1-800-343-4418 (in Mass. 617-264-8635).
Or write: NEC Information Systems, Department 1610,
1414 Massachusetts Ave., Boxborough, MA 01719.

NEC PRINTERS. THEY ONLY STOP WHEN YOU WANT THEM TO.

C&C
Computers and Communications

Spinwriter is a registered trademark of NEC Corporation. Pinwriter is a trademark of NEC Corporation.

NEC
NEC Information Systems, Inc.

CIRCLE 294 ON READER SERVICE CARD

CLOSE TO 1/4 MILLION APPLE II'S SAVED

SYSTEM SAVER® from Kensington Microware quietly protects close to 1/4 million Apple® II's every day. Often referred to as "the piece Apple forgot," System Saver's unique combination of features have made it the most versatile, most convenient, best selling accessory ever made for the Apple.

System Saver organizes your power needs.

To make your Apple system more convenient, System Saver provides extra outlets for your monitor and printer, while replacing the Apple's power cord. One front-mounted power switch controls your whole system.

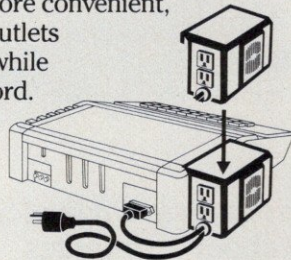

System Saver solves power line problems.

Impurities in the power supply cause 70-90% of all microcomputer malfunctions. Line noise can be interpreted as data, confusing your Apple and causing annoying system errors. Power surges and spikes can do costly damage to your computer's delicate circuitry.

System Saver clips surges and spikes at a safe level and filters out line noise. It makes your Apple more accurate, more efficient and more reliable.

System Saver keeps your Apple cool.

Peripheral cards added to your Apple not only generate heat, they block any natural air flow through the computer. The resulting high temperature conditions can potentially shorten the lives of both your Apple and your peripheral cards.



System Saver's quiet fan draws a breath of fresh air across the Apple's mother board, over the power supply and out the side ventilation slots at the rate of 17 cubic feet per minute.

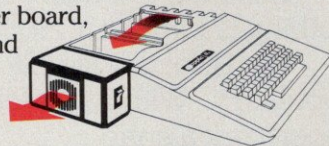

Close to 1/4 million Apple owners think of System Saver as the piece Apple forgot. And 1/4 million well-protected Apples agree. Available at your local dealer. For more information, contact Kensington Microware, 251 Park Avenue South, NY, NY 10010, (212) 475-5200 Telex: 467383 KML NY.

 **KENSINGTON®
MICROWARE**

The third part
of a four-part
tutorial on using
the language of
the LaserWriter
printer

Text Presentation with

POSTSCRIPT

Working with text is naturally one of the strong suits of the PostScript language built into every Apple LaserWriter printer. In this third part of the *A+* series on working with PostScript, we'll take a look at how this powerful page-description language handles text presentation.

As usual, if you have access to a LaserWriter you can try out the examples using an Apple II, Macintosh, or any other computer with a serial port—and if you don't want to get involved, note again that most application programs automatically take care of all the details of working with PostScript.

To PostScript, text is, on the one hand, a special class of the more general category of graphics shapes, and, on the other, a set of special codes. Thus, all the graphics commands that apply to other shapes in PostScript also apply to text. In addition, text presentation has some special commands and procedures of its own.

Remember that PostScript is a stack-oriented language. Operations get their inputs from this variable-length list of values, and results or other items not immediately needed are pushed back onto the stack until popped back off. PostScript actually has four stacks, but the one we're most concerned with is the operand stack.

PostScript uses the post-fix form of notation, with the input values expressed first, followed by the operation that acts on them.

```
34 add
rather than
add 3 and 4 or 3 + 4
```

Programs don't need a special overall format, but lines starting with a percent sign (%) are treated as comments.

In the first two articles, we saw how producing a printed line on the page entails picking a font, making it the right size, establishing a position on the page, specifying the string to be printed, and then telling the LaserWriter to output the page. Our simple program was:

```
% pick a font
/Times-Roman findfont
% scale it to 12 point
% set it as the current font
12 scalefont setfont
% move over 1 inch, up about 5
72 396 moveto
% image the text at that point
```

Working with text
is naturally
one of the strong
suits of the PostScript
language
built into every
Apple LaserWriter
printer.

```
(this page intentionally) show
(not left blank) show
% print out the page
showpage
```

Now, let's look at some of the more special ways PostScript can handle text.

We'll start by making a family of related typefaces from the ordinary Times-Roman font included in the LaserWriter. Typeface designers would probably say that the results of these digital transformations are not nearly as good as a specifically designed form of the letters, but they'll do for most everyday purposes.

First, we make a copy of the Times-Roman font, calling it Ourfont. Remembering that operators and commands get their values from the stack, we have

```
% put a name on the stack
/Ourfont
% tell PostScript to retrieve a
% copy of
% Times-Roman and put it on the
% operand stack too
/Times-Roman findfont
% define that copy as Ourfont
def
```

We're now ready to start making variations. We'll use `makefont`, which both scales and slants a font using a six-element ordered group of numbers called a matrix. We'll mostly skip over the mechanics of matrix multiplication here (see "Matrices in Space" sidebar). Instead, we'll follow some simple plug-

in formulas for using makefont matrices. For a start, let's make a version of Ourfont that's much taller than normal (or much narrower for its height, depending on how you think of it). To scale a font, we plug in the scale factor in the x (horizontal) direction as the first value, the scale factor in the y (vertical) direction as the fourth value, and leave the others as zero.

```
Our code thus becomes
% define Ourfont as a copy of
% Times-Roman
/Ourfont/Times-Roman findfont
def
% put a copy on the stack,
% followed by the matrix, then
% create the new font
Ourfont [12 0 0 36 0 0] makefont
% make that new font the current
% font
setfont
% move to position on the page,
% write
2 16 432 moveto
(Tall fonts and) show
% wait to print until the next
% part
```

In addition to making the font larger or smaller, we can also slant the letters. Again, we use makefont, but this time the matrix is more complex. To get a slant to the right, for example, we want the top of the letter to sit further over to the right than the bottom of the letter does, with the horizontal skew proportional to vertical distance (halfway up, the letter should be displaced half as far over as at the top, and so on). The mathematical function that gives that proportionality factor for x as a function

of y and the specified angle, is the tangent. To slant a letter, we put the tangent, multiplied by the horizontal-scale factor, in the matrix's third position.

We have one small additional complicating factor: PostScript doesn't have the tangent function built-in, but instead expects us to find it by dividing the sine by the cosine. Continuing on with our example, we

```
% put a copy of the font on the
% stack
Ourfont
% follow it with our matrix
% with the third position filled
% with the sine of 30 degrees
% divided by the cosine of 30
% degrees, multiplied by 24
% points
[24 0 30 sin 30 cos div 24
mul 24 0 0]
% create the new font, set it as
% current
makefont setfont
% continue imaging text at our
% current position
(slanted fonts) show
% print the page
showpage
```

The results should look like this:

Tall fonts and *slanted fonts*

Next, we'll see how we can get PostScript to make text fit into a specified space. We might need to do that, for example, to create justified columns in a report or to label a chart.

The basic strategy is to measure the length of a text phrase, then subtract the length from the intended measure.

We'll follow that by dividing the remaining distance among the spaces in the line, which we'll then add to the image. Because we want to use several values more than once, but PostScript operations take parameters from the top of the stack, we'll have to use several exchange operations to reorder the pending values on the stack.

```
% save the environment
gsave
% set up a 12-point font
/Times-Roman findfont
12 scalefont setfont
% move in 4 inches, up 8
288 572 moveto
% put two copies of the string on
% the stack
(All the news that fits in print)
dup
% make another copy, use it to
% count length, which uses up
% the copy and leaves the length
dup stringwidth
% get rid of change in vertical
% position because we just want
% an even horizontal edge
pop
% exchange the length and the
% extra copy of the string
% we left on the stack with the
% first "dup"
exch
% now, we need to set up the stack
% to count the spaces in a line.
% First, we put a zero on the
% stack for a counter
0
% pull the string up above the 0
% on the stack
exch
```

Zimco International

85-39 213th Street Queens Village, NY 11427

#23

FREE SHIPPING
(on prepaid orders)

800-227-6647
In NY Call (718) 479-7888

Order desk open 7 days a week!

PRINTERS:		MONITORS		MODEMS:		RAM CARDS:			
Brother HR-15	\$359	Okidata 92P	\$329	Amdek 710 Color RGB	\$553	Anchor Signalman 300/1200	\$223	16k Ram Card	\$ 35
Brother HR-24	\$970	Okidata 93P (200cps)	\$565	Amdek RGB DV3 Interface	\$124	Anchor Volksmodem 300	\$ 49	128k Ram Card	\$139
Brother HR-25	\$627	Qume Sprint 11 (40 cps)	\$1277	BMC Color 919 1U	\$189	Anchor Volksmodem 1200	\$179	ALS ADD RAM for //+	\$ 53
Brother HR-35	\$859	Qume Sprint 11 (55 cps)	\$1464	BMC 12" Amber	\$115	Anchor Volksmodem Cables	\$ 10	Applied Eng. 80 Column	\$130
C. Itoh Starwriter F-1040	\$849	Qume Sprint 11 (90 cps)	\$1995	BMC 12" Green	\$ 81	Hayes Smartmodem 300	\$140	Applied Eng. Ram Works 64k	\$155
C. Itoh 1550 P	\$510	Qume Letter Pro 20	\$435	Comex Amber	\$ 85	Hayes Smartmodem 300 (/c)	\$159	Applied Eng. Ram Works 128k	\$185
C. Itoh 7500ap	\$220	Panasonic KXP-1090	\$193	Comex Green	\$ 85	Hayes Smartmodem 1200	\$399	Applied Eng. Ram Works 256k	\$249
C. Itoh Prowriter 8510ap	\$299	Panasonic KXP-1092	\$249	IBM Monochrome	\$374	Hayes Smartmodem 2400 RS232	\$260	Applied Eng. Ram Works 512k	\$349
Citizen MSP-10	\$311	Panasonic KXP-1093	\$445	NAP Amber	\$ 79	Hayes Micromodem 24	\$639	Applied Eng. Ram Works 1 meg	\$389
Citizen MSP-15	\$452	Panasonic KXP-3151	\$445	NEC JC 1215MA Color	\$231	Novation Apple Cat II	\$145	MPC 16k Ram Card for //+	\$ 59
Citizen MSP-20	\$452	Riteman 15 (132cps)	\$434	NEC JC 1201 12" Hi Res	\$129	Novation Apple Cat 212 System	\$199	Quantin 16k Ram Card	\$ 59
Citizen MSP-25	\$585	Riteman 120	\$239	NEC 1201G	\$ 99	Novation Apple Cat 212 Upgrade	\$373	Z Ram 512k Card (/c)	\$499
Daisywriter 2000 w/48K	\$829	Silver Reed EXP-400	\$247	NEC 1205A	\$ 99	Novation J-Cal	\$325		
Epson Homewriter	\$249	Silver Reed EXP-500	\$255	NEC 1206G	\$ 79	Novation Smartcat 300/1200	\$ 98		
Epson FX-80 +	\$349	Silver Reed EXP-550	\$415	Panasonic DTH-103 Hi Res	\$395	Novation Smartcat Plus (MAC)	\$379		
Epson FX-100	\$499	Silver Reed EXP-770	\$739	Panasonic DT5-101	\$178	Prometheus Option	\$338	Printer Interface, Parallel	\$ 40
Epson LX-80	\$497	Star Daisy	\$337	Panasonic D-1300	\$315	Prometheus Pro-Modem	\$150	Modem Interface RS232/Serial	\$ 45
Epson LX-90	\$259	Star SB10	\$749	Panasonic M-140 RGB	\$395	Printer Interface	\$309	Music Card	\$ 69
Epson LQ 1500	\$959	Star SD10	\$350	Princeton HX-12 RGB	\$450	Clock Card	\$479	RGB Card	\$ 45
Epson RX-80	\$219	Star SD15	\$470	Princeton MAX-12	\$470	ALS Printmate	\$ 45	ALS Serial Interface	\$ 88
Epson RX-80 FT	\$269	Star SG10	\$229	Quadram Amberchrome TTL	\$163	Apicom Super Serial Int.	\$115	Apicom Super Function Card	\$168
Epson RX-100	\$385	Star SG15	\$388	Sakata Amber SA-1000	\$326	OM Grappier +	\$18.50	OM Grappier + Buffered	\$ 79
Epson Starwriter 3515	\$399	Star SR10	\$495	Sakata Color SC-100	\$108	OM Grappier +, Bufferboard for	\$30.00		\$ 63
Mannesman Tally MT-180L	\$560	Star SR15	\$829	Sakata Color SC-200	\$419				
Mannesman Tally MT-180L	\$729	Star STX-80	\$155	Sakata Color SC-300	\$633				
Mannesman Tally Spirit 80	\$280	Toshiba 1340	\$589	Sakata Green SC-1000	\$108				
NEC Spinwriter 2000 (20cps)	\$641	Toshiba 1341	\$1240	Sanyo DMC 6500 RGB/Green	\$259				
NEC Spinwriter 3510 RS232C	\$1294			Synco Amber or Green	\$ 94				
NEC Spinwriter 3530	\$1345			Taxan Amber	\$120				
NEC Spinwriter 3550 (35cps)	\$1099			Taxan Green	\$125				
NEC Spinwriter 7710 (55cps)	\$1750			Taxan RGB Vision 3	\$397				
NEC Spinwriter 7720 (55cps)	\$2520			Taxan 210 Color	\$249				
Okidata 82A	\$302			Taxan 440 Color	\$559				
Okidata 83A	\$534			Taxan 12" IBM Amber	\$136				
Okidata 84P	\$650								

Terms: Any order may be returned within 30 days for full credit subject to a 10% restocking fee. Stock situations may vary. All prices reflect a 3% cash discount. NYS residents add 8.25% sales tax. Personal/corporate checks — allow 2 weeks to clear. Prices do not include shipping and handling charges unless order is prepaid by cash, certified check or money order. Computer sales are not subject to free shipping. Mastercard and Visa do not qualify as prepaid orders. Purchase orders are accepted with prepayment only, except for government agencies. Prices are subject to change without notice. We are not responsible for typographical errors.

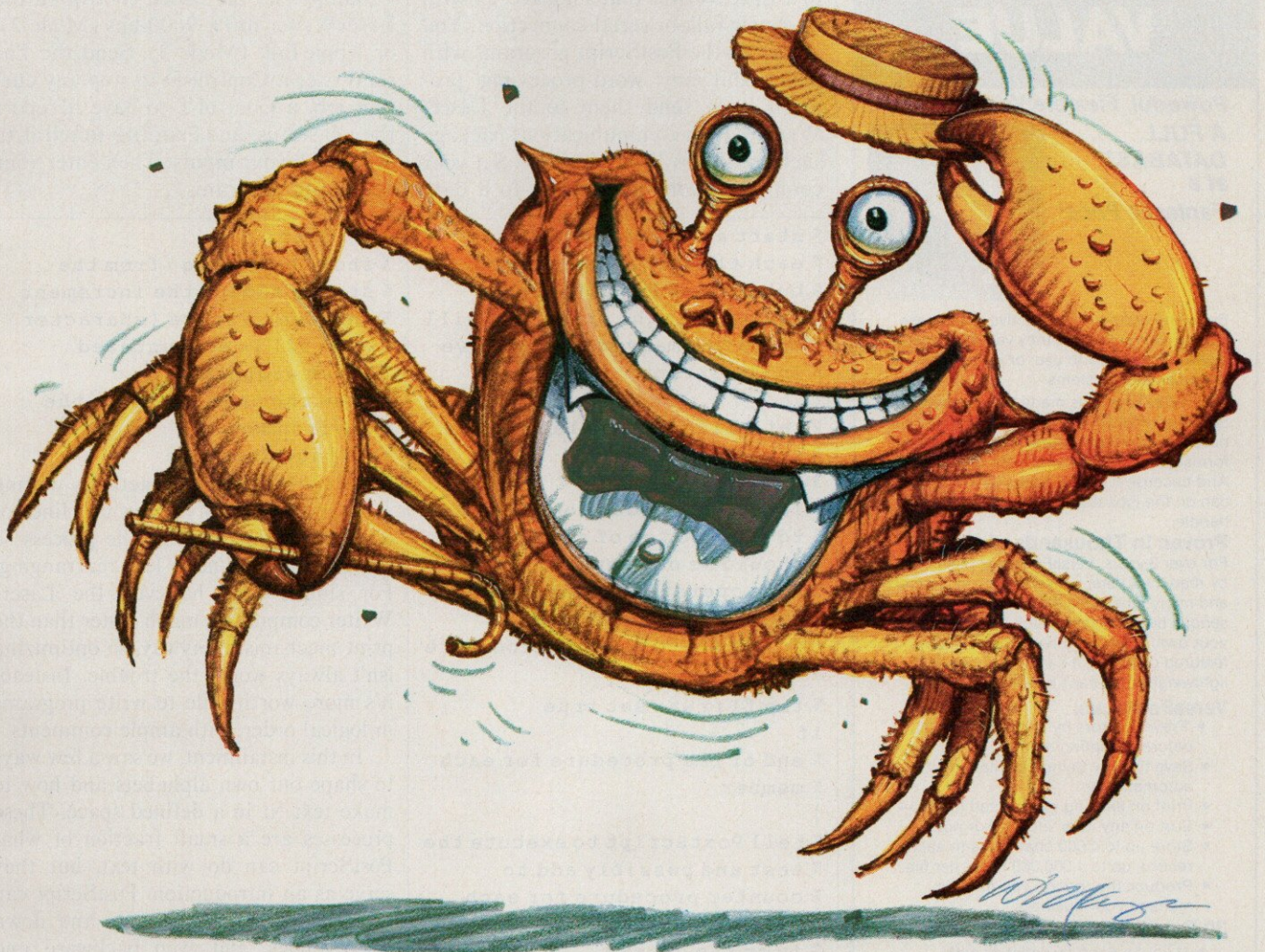

Sometimes the best way to get ahead is to go sideways.

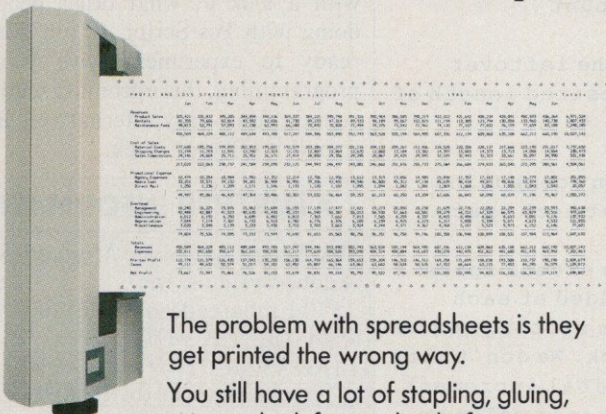

The problem with spreadsheets is they get printed the wrong way.

You still have a lot of stapling, gluing, or taping to look forward to before your printout is readable.

To really get ahead, go Sideways.™

Sideways is the clever software program that prints your spreadsheets—you guessed it—sideways. So your spreadsheet columns need never fall off the edge of your printer paper again.

With Sideways on your side, no spreadsheet you invent with Lotus 1-2-3,® Symphony,™ VisiCalc,® Multiplan,® or SuperCalc™ is too wide! And it's just as powerful an ally when you're creating far-into-the-future schedules and PERT charts. So for a presentable printout, get rid of that glue stick and scotch tape—put your best foot forward and go Sideways.

You can go Sideways today with an IBM® PC or an Apple® II, and over a dozen different printers, including Epson,® Okidata, IBM,® Apple,® C. Itoh and Mannesmann Tally. Ask for Sideways at your local ComputerLand®, Entre, or other computer store. Or mail a \$60 check to Funk Software, P.O. Box 1290, Cambridge, MA 02238. Or call 617-497-6339. MC/Visa accepted.

SIDEWAYS™
SIDEWAYS PRINTS SPREADSHEETS SIDEWAYS.

INCREDIBLE DATABASE VALUE

**Powerful, Flexible, Versatile -
A FULL
DATABASE
at a
Fantastic Price!**



Everyone knows how effective a database can be. But until now, they've either been powerful but hard to use, or just simple personal filing systems.

Now VersaForm has made the database both powerful AND easy to use. Because it's based on your own knowledge of business forms, you can tailor it to your own needs. And because it's a full-featured database, it can do the jobs that lightweights just can't handle.

Proven In Thousands of Offices

For over 3 years, VersaForm has been used by manufacturers, bankers, doctors, farmers, and many others. It's THE program for serious business tasks such as invoicing, to your own needs. And because it's a full-featured database, it can do the jobs that lightweights just can't handle.

VersaForm can:

- Prevent errors by checking entries before accepting them.
- Save time by doing calculations automatically.
- Print on existing pre-printed forms —
- Sort on any item, indexed or not.
- Store up to 4,000 characters in each record, up to 4,000,000 bytes per file.
- Produce the reports you need to manage your business.

30 Day/1 Year Guarantee

- If you're not fully satisfied with VersaForm, return it within 30 days and we'll refund your money.
- Upgrade to our multi-file system, VersaForm XL, within one year, and get Full Credit for the price!

Compare at over \$300.

Multi-File
version \$99
(IBM PC Only)

\$69

Note: Prices subject to change after 60 days.

Credit card members can order by phone.

Toll-Free: 1-800-538-8157 x:880

In California, call:

Toll-Free: 1-800-672-3470 x: 880

Applied Software Technology (408) 370-2662
Dept. A-P 1350 Dell Ave. Suite 206
Campbell, CA 95008

Yes! RUSH me VersaForm
for the IBM PC (\$69) _____ (128K, 2 drives)
* Apple II (+,e,c) (\$69) _____ (64K, 2 drives)
VersaForm XL (MULTI-FILE)

for the IBM PC (\$99) _____ *(196K, 2 drives)
Enclose check or money order with coupon.
Include \$4.50 for U.S. postage and handling, \$7.00
for C.O.D. California residents add 6.5% tax. (Allow
3-4 weeks for delivery.)

___ My check or money order is enclosed.

Charge my: ___ MasterCard ___ Visa ___ C.O.D.
Acct. No.: _____ Expires: _____

PLEASE PRINT CLEARLY

Name _____

Address _____

City _____ State _____ Zip _____

Phone _____ Sign here _____

▶ WRITING YOUR OWN POSTSCRIPT PROGRAMS

If you'd like to try your hand at PostScript programming, you'll need access to a LaserWriter that's hooked up with an AppleTalk or serial connection. You can write the PostScript programs with just about any word-processing program, then send them to the LaserWriter with a communications package such as Access II or MacTEP. Set your communications parameters to 8 data

bits, 1 stop bit, no parity, and the X-ON/X-OFF protocol. You can use 1200 bps (set the Mode control on the LaserWriter to 1), 9600 bps (Mode 2), or AppleTalk (Mode 3). Send the LaserWriter a Control-D to stop any current job, a Control-T to have it report the job status, and Execute to tell it to echo back your inputs. Then enter your PostScript programs.

```
% start a procedure to do for
% each element of the string,
% but mark it for deferred
% execution; the procedure will
% count how many spaces we have
% in the string
{
% set a flag if the element is a
% space (code 32)
32 eq
% leave a procedure on the stack
% to add 1 to top of stack, which
% should be our counter when
% this operation is executed
{1 add}
% do the add to counter procedure
% if
% the flag was set true
if
% end of the procedure for each
% member
}
% tell PostScript to execute the
% test and possibly add to
% counter procedure for each
% element of the string (which
% is on the stack)
forall
% now exchange so the length is
% on top of the count
exch
% now subtract the leftover
% space from a desired length of
% 4 inches (72 x 4)
288 exch sub
% do the division, computing
% length to add at each space
exch div
% we now have the excess space
% that must be added at each
% space position sitting on the
% top of the stack. We don't want
% any extra vertical increment
% but we need a y-axis value on
% the stack to be taken off
% by widthshow
0
% widthshow needs the string at
% the top of the stack, and it's
% now 3 down so pull the third
% element to the top and roll all
% the others down
```

```
3 - 1 roll
% show the string (from the
% stack) adding the increment
% whenever a space (character
% code 32) is encountered
32 exch widthshow
% show the page, restore the
% environment
showpage grestore
```

Of course, if we were actually writing a program to justify (even up) lines of text, we might optimize the process so the stack would need less rearranging. For simple text, however, the LaserWriter computer is much faster than the print mechanism anyway, so optimizing isn't always worth the trouble. Instead, it's more worthwhile to write programs in logical order, with ample comments.

In this installment, we saw a few ways to shape our own alphabets and how to make text fit in a defined space. These processes are a small fraction of what PostScript can do with text, but they serve as an introduction. PostScript can literally write in circles, up and down steep angles, and even backward and forward.

Next month, we'll conclude this series with a look at what other people are doing with PostScript. If you don't feel ready to experiment with your own programming, this upcoming section will contain some easy alternatives. Be sure to pull it off your stack. +

▶ FURTHER INFORMATION

PostScript Language Manual (\$30)
Adobe Systems, Inc.

1870 Embarcadero Road, Suite 100
Palo Alto, CA 94303
(415) 852-0271

CIRCLE 538 ON READER SERVICE CARD

Inside LaserWriter (includes *Post-Script Language Manual*) (\$75)
Apple Computer, Inc.

467 Saratoga Avenue, Suite 621
Attn: Inside LaserWriter
San Jose, CA 95129
(408) 988-6009

CIRCLE 539 ON READER SERVICE CARD

► MATRICES IN SPACE

PostScript keeps track of shapes and points as grid locations, but the grid may be different for the individual characters, for the page description, and for the output device. We can also set up temporary grids with new origins (0,0 position) or at an angle to the existing lines. Many of the PostScript operators are concerned with making a transformation from one grid to another.

One effective way to go between grids is by using matrix multiplication. PostScript makes extensive use of these multipliers, from mapping the character space into the user space, to mapping the user space onto the output device itself. As with many of the details of PostScript, you can start off without worrying at all about matrix mathematics and let PostScript automatically calculate the essential values. If you're curious or ready for more advanced operations, however, here's how graphic matrices work.

Starting with any point value in two dimensions, we extend that (X, Y) pair to triplet matrix of [x y 1]. We can then accomplish the three basic graphics transformations by multiplying by the appropriate three-by-three matrix. For those of you who haven't learned matrix multiplication or have forgotten it along the way, multiplying the matrix

$$\begin{bmatrix} A & B & 0 \\ C & D & 0 \\ E & F & 1 \end{bmatrix} \text{ by } [X \ Y \ 1]$$

yields a new three-element matrix with
 first term = $(X*A)+(Y*C)+(1*E)$
 second term = $(X*B)+(Y*D)+(1*F)$
 third term = $(1*0)+(1*0)+(1*1)$.

To translate (move position sideways), we set the the matrix to

$$\begin{bmatrix} 1 & 0 & 0 \\ 0 & 1 & 0 \\ dx & dy & 1 \end{bmatrix}$$

which multiplied by [X Y 1] yields
 $[(X*1)+(Y*0)+(1*dx)$
 $(X*0)+(Y*1)+(1*dy)$
 $(1*0)+(1*0)+(1*1)],$

simplifying to

$$\begin{aligned} X' &= X+dx, \\ Y' &= Y+dy, \\ 1 &= 1. \end{aligned}$$

To scale (move up or down in size), the matrix becomes

$$\begin{bmatrix} Sx & 0 & 0 \\ 0 & Sy & 0 \\ 0 & 0 & 1 \end{bmatrix}$$

which multiplied by [X Y 1] yields

$$\begin{aligned} [(X*Sx)+(Y*0)+(1*0) \\ (X*0)+(Y*Sy)+(1*0) \\ (1*0)+(1*0)+(1*1)], \end{aligned}$$

simplifying to

$$\begin{aligned} X' &= X*Sx, \\ Y' &= Y*Sy, \\ 1 &= 1. \end{aligned}$$

Finally, to rotate the axes at an angle, the matrix is

$$\begin{bmatrix} \cos(a) & -\sin(a) & 0 \\ \sin(a) & \cos(a) & 0 \\ 0 & 0 & 1 \end{bmatrix}$$

which multiplied by [X Y 1] yields

$$\begin{aligned} [(X*\cos(a))+(Y*\sin(a)+(1*0) \\ (X*-\sin(a))+(Y*\cos(a))+(1*0) \\ (1*0)+(1*0)+(1*1)], \end{aligned}$$

simplifying to

$$\begin{aligned} X' &= X*\cos(a) + y*\sin(a) \\ Y' &= X*-\sin(a) + Y*\cos(a) \\ 1 &= 1 \end{aligned}$$

Although these matrix operations seem tedious by hand, they're reasonably easy for a computer. More complex transformations can be constructed using combinations of displacement, scale, and rotation in the proper sequence.

Confused About Data Base Programs?

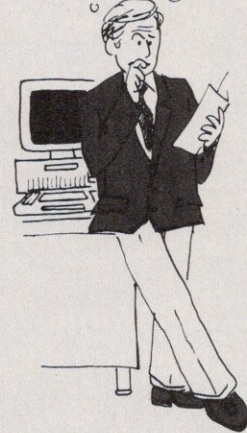
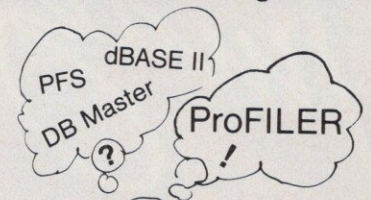

When you compare feature and price there is no confusion.

ProFILER 2.0 is HERE!

The Data Manager for the Apple Computer with all the NEW features you've been waiting for.

8 times faster than DOS 3.3 - Twice as fast as ProFILER 1.0

FEATURE	ProFILER†	PFS File*
Multiple Forms per Disk	YES	NO
Maximum Records per File	1500+	1000
(65,000 w/ ProFILE Hard Disk)	YES	NO
Report Generator Included	YES	NO
	FREE	(\$100)
Pro DOS Operating System	YES	NO
	FREE	
Full Screen Editor	YES	NO
Works on Apple II+, IIe, IIc, III, Franklin	YES	YES
Arrow Keys function OK	YES	NO
Multiple Index Files	YES	NO
Auto Catalog of Data Files - NEW	YES	NO
Variable Printer Initialization - NEW	YES	NO
Reports to Screen or Printer - NEW	YES	NO
Easy Word Processor Interface - NEW	YES	NO
Apple writer II® Mailmerge Interfaces - NEW	YES	NO
Cost DataBase	\$89.95	\$90.00+
Report Generator	FREE	\$90.00+
TOTAL COST	\$89.95	\$180.00+

ALL THESE FEATURES FOR ONLY \$89.95

PFS Conversion Utility Program
 Converts PFS files easily to ProFILER format
\$39.95

ProFILER available from selected dealers or directly from:

Pm software

19731 Providence Ln. • Box 1788 Huntington Bch, CA 92647

(714) 963-2221 • (714) 548-5429

Terms: Send \$89.95 (plus \$3.00 for shipping)

CA residents add 6%)

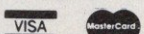

Mastercard, VISA Check or money order

*Apple, Applewriter II and ProFILE are registered trademarks of Apple Co., Inc.
 *PFS is a registered trademark of Software Publishing Corp.

† ProFILER by Custom Computer Products

CIRCLE 150 ON READER SERVICE CARD

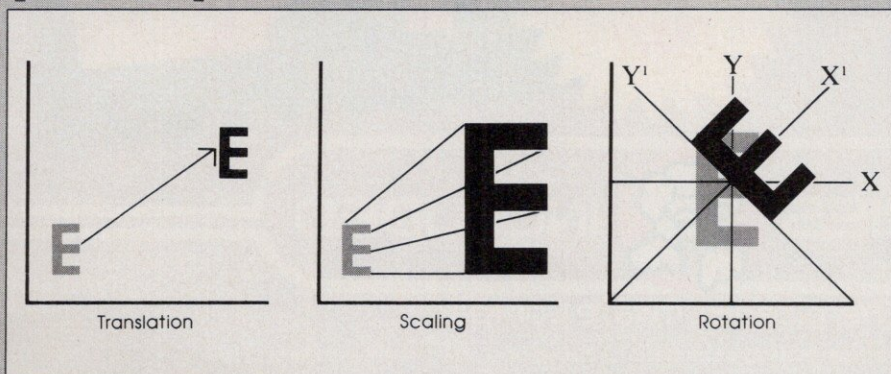

Figure 1: Complex matrix operations

Imagine...

For
COMMODORE 64
ATARI
APPLE IIe/c AND IBM PC

**A WORD PROCESSING PROGRAM!
AN INFORMATION MANAGEMENT PROGRAM!
A TELECOMMUNICATIONS PROGRAM!**

ALL THREE PROGRAMS, ON ONE DISKETTE!, FOR ONLY \$49.95*!

"Quite simply the best! The highest rating possible...the package should be part of every (computer) library." — ANALOG COMPUTING

"Russ Wetmore has done an EXCELLENT job! The program is flexible, powerful and very easy to use. \$49.95 buys a heck of a lot of program." — REVIEW BY ARTHUR LEYENBERGER

"Performance: ★ ★ ★ ★ (Excellent) Value: ★ ★ ★ ★ (Excellent)"

This three-in-one package is a bargain... one of the finest values on the market."

FAMILY COMPUTING

HOMETEXT WORD PROCESSOR.
HOMEFIND INFORMATION MANAGER.
HOMETERM TELECOMMUNICATIONS

Together they are **HomePak**: the three most important and most useful home computer applications in one integrated system — on one diskette!

The reviewers are unanimous: any one of these programs **alone** is well worth the price. So you're getting **three times the computing power**, with this exceptionally easy to use package:

- all commands in simple English; no complex computer jargon, no obscure instructions
- all key commands are immediately available on the screen menu; additional commands can be called up for the more experienced user
- to help you, system status is displayed right on the screen

And it's easy to use the three programs together. For example, in the "Merge" mode, you can take data stored in **HOMEFIND** and print letters and labels using **HOMETEXT**. Or, use **HOMETEXT** to write reports based on information you've called up via **HOMETERM**.

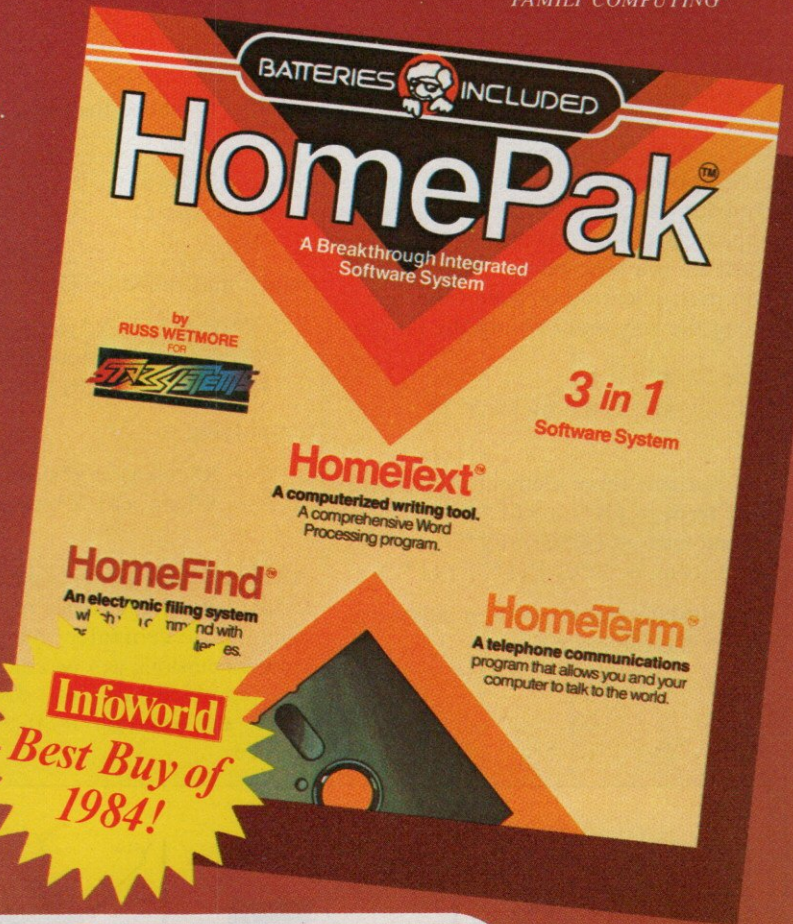

BATTERIES INCLUDED



"The Energized Software Company!"

30 Mural Street
Richmond Hill, Ontario
L4B 1B5 CANADA
(416) 881-9941
Telex: 06-21-8290

17875 Sky Park North, Suite P
Irving, California
USA 92714
(416) 881-9816
Telex: 509-139

WRITE TO US FOR FULL COLOUR CATALOGUE of our products for COMMODORE, ATARI, APPLE and IBM SYSTEMS

FOR TECHNICAL SUPPORT OR PRODUCT INFORMATION PLEASE PHONE (416) 881-9816

*Manufacturer's suggested list price—retailers may sell for less

© 1985 BATTERIES INCLUDED. APPLE, ATARI, COMMODORE AND IBM ARE REGISTERED TRADEMARKS RESPECTIVELY OF APPLE COMPUTERS INC., ATARI INC., COMMODORE BUSINESS MACHINES INC. AND IBM BUSINESS MACHINES INC.

In previous articles in this series, I have introduced you to ProDOS directories, prefixes, pathnames, and all the Applesoft disk commands defined in a system program called BASIC.SYSTEM. This month we're going to take a close look at a utility program on the ProDOS User's Disk that you can use to perform many convenient file- and disk-handling chores, most of which the simple BASIC.SYSTEM commands cannot handle. This program is called FILER.

FILER's most common use is to format or copy entire disks or to transfer a file, or a group of files, from one disk to another. Users of DOS 3.3 will recognize FILER as the ProDOS equivalent of FID.

You start FILER up by booting the ProDOS User's Disk and entering the command -FILER from the Applesoft Direct mode.

When FILER begins, you will see a menu of five items:

- ? - TUTOR
- F - FILE COMMANDS
- V - VOLUME COMMANDS
- D - CONFIGURATION DEFAULTS
- Q - QUIT

To make a selection, just press the character that appears to the left of the menu item.

Three of the entries in FILER's opening menu are straightforward, and I won't discuss them here at length. TUTOR displays two pages of introductory information for new users of the program. The CONFIGURATION DEFAULTS entry simply allows you to set the default disk slot and drive numbers for use when you invoke volume commands.

You can also specify that output is to go to the monitor only or to the monitor and a printer. Note, however, that enabling the printer does not cause the out-

put of all commands to print; I'll point out the commands that are affected as I discuss them.

QUIT lets you exit from FILER and transfer control to another ProDOS system program; it works just like the BASIC.SYSTEM BYE command. That is, after you enter it, you will get a message to enter the prefix and pathname of the next system program to be used.

The remaining two entries, FILE

you to enter the slot number and drive number of the disk that is to be acted on. The slot number refers to the number of the connector at the back of the Apple II in which the controller card for the disk drive has been installed. If you are using a Disk II drive, this number is probably 6. The drive number is either 1 or 2, depending on whether the drive cable is connected to the upper (1) or lower (2) connector on the controller card.

You will also have to enter a volume directory name when you use some of the volume commands. As we saw in June, the rules for entering such a name are the same as those for standard ProDOS files: The name can be up to 15 characters long and must begin with an alphabetic character; the other characters can be alphabetic characters, digits, or periods. None of the volume commands allow you to enter illegal characters in a volume name; instead, you will hear a beep, and the character will be ignored.

If you make a mistake when typing in a volume name, you can use the left-arrow key to move the cur-

sor to the erroneous character and then type over it. Once you've entered the name properly, press Return. Note that FILER ignores all characters appearing at or after the cursor position when you press Return; to include them, move over them with the right-arrow key before pressing Return.

Now let's take a look at each of the volume commands in the order in which they appear in the VOLUME COMMANDS menu.

FORMAT A VOLUME

Before you can use a disk with ProDOS, you must properly format it, a process that involves laying out templates for each data block and for set-

UNDERSTANDING ProDOS

PART FOUR OF A FIVE-PART TUTORIAL ON THIS NEW OPERATING SYSTEM PROGRAM FOR THE APPLE II FAMILY. THIS MONTH WE TAKE A CLOSE LOOK AT FILER, A UTILITY PROGRAM ON THE ProDOS USER'S DISK THAT YOU CAN USE TO PERFORM MANY FILE- AND DISK-HANDLING CHORES, SUCH AS FORMATTING OR COPYING ENTIRE DISKS OR TRANSFERRING FILES FROM ONE DISK TO ANOTHER.

COMMANDS and VOLUME COMMANDS, represent the bulk of FILER. Let's begin our detailed look at them with the volume commands and then move on to the file commands.

The Volume Commands

When you press V to select VOLUME COMMANDS from FILER's initial menu, you will see a list of eight commands in another menu, one of which is a TUTOR command similar to the one mentioned above. Before we get to the other seven commands, let's lay down some of the ground rules that you must follow when you're in this part of FILER.

Most of the volume commands ask

LEROY'S CHEATSHEET®

APPLE IIe KEYBOARD OVERLAYS

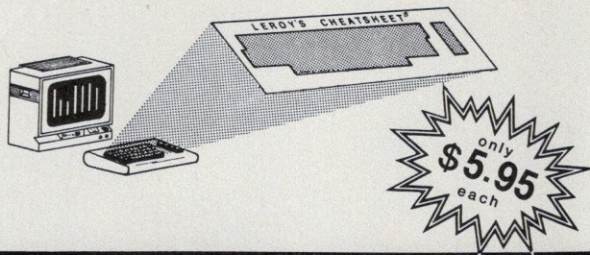

FOR APPLE IIe

LEROY'S CHEATSHEETS® are plastic laminated keyboard overlays designed for use with popular software and hardware for APPLE computers.

These DIE-CUT overlays are designed to fit over the keyboard surrounding the keys with commands and controls grouped together for easy references.

LEROY'S CHEATSHEETS® make life easier for you

APPLE IIe KEYBOARD OVERLAYS

- PRACTICALC II
- FLIGHT SIMULATOR II
- LOGO (Terrapin)
- LOGO (Apple)
- SCREENWRITER IIe
- GRAPPLER+ W/Print Workshop
- GEMINI 10X & 15X PRINTER
- EPSON RX & FX 80 & 100
- OKIDATA MICROLINE 92 & 93 PRINTER
- BLANKS (set of 3)
- FOR THE BEGINNER

A + B



Qty. X \$5.95 \$

*Shipping & handling \$ 1.00

6% sales tax \$
(PA residents only)

TOTAL \$

U.S. FUNDS
NO COD's PLEASE

* **SHIPPING AND TERMS:** US and Canada \$1.00 per order. Foreign orders \$3.00. Cash, check or money order. Phone orders are Visa and Mastercard only. No COD's.

Dealer inquiries welcome

Name _____

Address _____

City _____ State _____ Zip _____

CHEATSHEET PRODUCTS inc

P.O. Box 111368 Pittsburgh PA. 15238



(412) 781-1551

Charge My VISA or Master Card NUMBER _____ EXPIRATION DATE _____

... OR SEE YOUR LOCAL DEALER !

ting up a blank disk directory and volume bit map. (ProDOS uses the volume bit map to keep track of block usage on the disk.) Some application programs, such as AppleWorks, allow you to format disks from within the program; most, however, rely on you to format disks yourself with FILER.

Formatting a disk volume is easy. You simply enter the slot and drive number for the disk and then a volume name. Specifying a volume name can be quite painless if you accept the displayed default name of the form /BLANKxx (where xx is a two-digit number) by just pressing Return.

If the disk you are about to format has already been formatted, you will see the warning message

DESTROY "/DISK.NAME"?(Y/N)

You get this message because the formatting process permanently erases any data already stored on the disk. If you really don't want to destroy all that data, you can cancel the operation by pressing N (or the Escape key). Otherwise, proceed by pressing Y.

The formatting procedure takes about 15 seconds. When it finishes, the message FORMAT COMPLETE appears, and the disk is then ready for use with ProDOS.

COPY A VOLUME

This command lets you make a duplicate copy of a disk. When you enter the command, you receive a request to enter the slot and drive numbers of the "from" (source) disk and the "to" (destination) disk. (If you have a one-drive system, enter the same number for both the source and the destination. FILER will tell you when to remove one disk and insert the other during the copying process.) Next you insert the disks and press Return. After that, you are asked to specify a volume name for the destination disk—the name of the source disk appears as a default, however, and you can accept it by pressing Return.

Before the copying process begins, FILER formats the destination disk, just as if you had entered the FORMAT A VOLUME command. Thus, if the destination disk is already formatted, FILER will ask you to verify that the volume is to be destroyed, before formatting begins.

After the formatting of the destination disk, the COPY A VOLUME command transfers the contents of the source disk to the destination disk by alternately reading from the source disk and writing to the destination disk—a total of nine passes is necessary to complete the copy. (Copying is a tedious procedure if you have a one-drive system, because you must swap disks after each pass.)

When the copying process ends successfully, you get a COPY COMPLETE message.

LIST VOLUMES

This command displays the slot and drive numbers and the volume name of the medium for each ProDOS disk device installed in the Apple II. For example, if you have a two-drive Apple IIe with an Extended 80-Column Card installed, the LIST VOLUMES command will display information in the following format (it will also send it to the printer if you have issued the CONFIGURATION DEFAULTS command):

SLOT	DRIVE	VOLUME
6	1	/APPLEWORKS
6	2	/DATA.DISK
3	2	/RAM

The slot 3, drive 2 volume called /RAM uses the 64K of

Hardware includes the components attached to it. The most important pieces of hardware in a computer system are the processor, memory and the processor. Next in importance are the circuits that adapt and convey information between the computer and peripheral devices. These circuits are called **interfaces**. Some are built into others, such as the controller card, can be installed in the computer's expansion slots. Finally, there are the external peripheral devices. **Input devices** for information going to the computer and **output devices** for information coming from the computer. Some devices, such as disk drives, are combination **input/output (I/O) devices** used for storage.

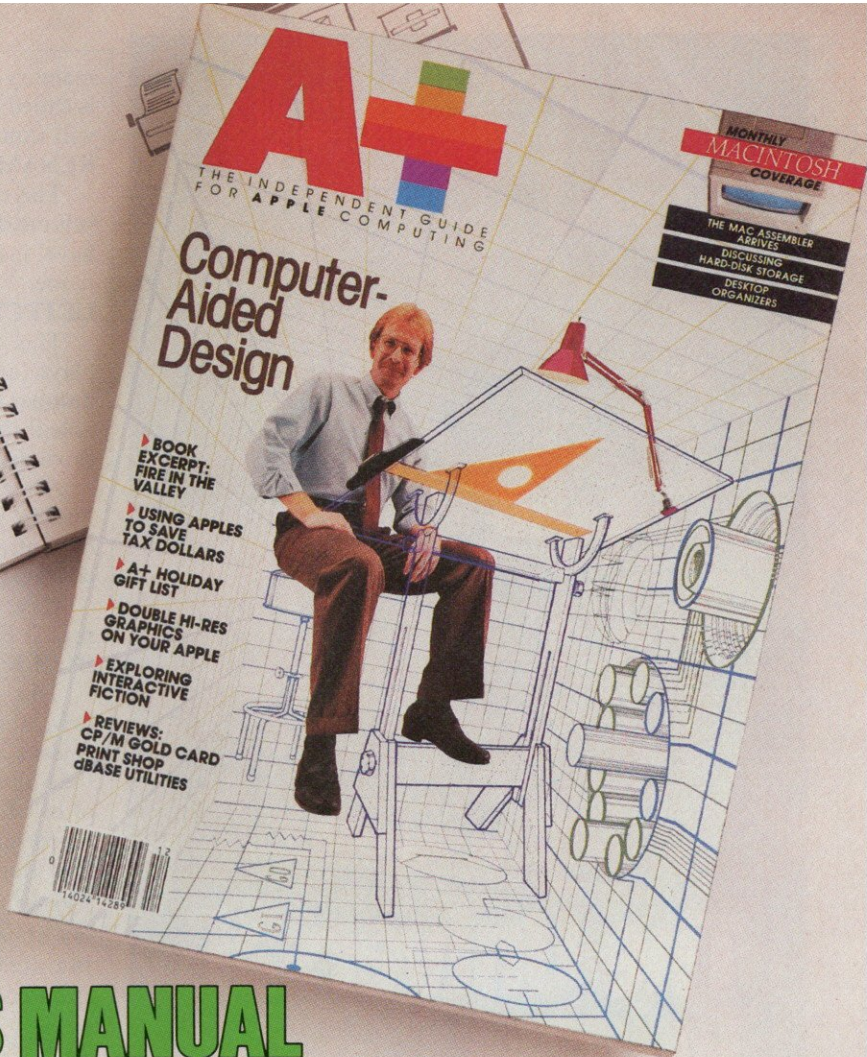
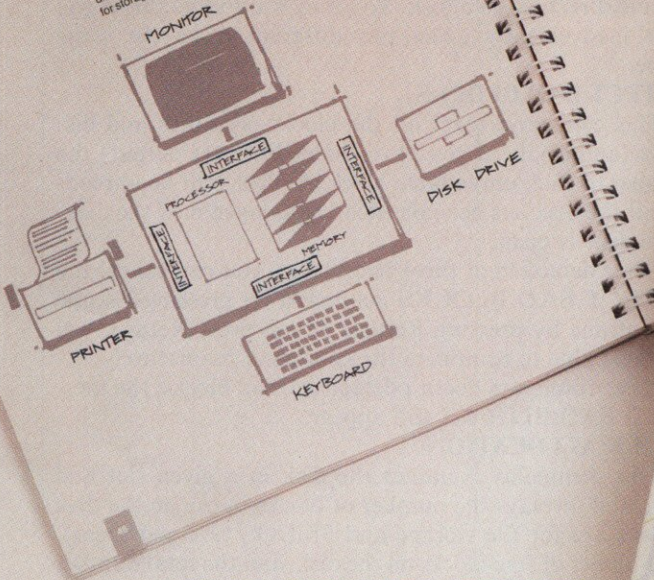

DISCOVER THE APPLICATIONS YOUR OWNER'S MANUAL NEVER TOLD YOU ABOUT IN **A+**

Your Apple owner's manual is a great starting point. But for current information on the newest applications—and the products that make them work—you need **A+**, The #1 Apple Magazine for the Apple II series and Macintosh computers.

▶ **Run Your Office More Efficiently and Profitably** Every issue of **A+** is a seminar series on the newest professional applications. You'll learn how to streamline your accounting and billing... reduce telephone costs... set up a database management system... select the right word processing software... transmit and receive data... and more!

▶ **Learn a Foreign Language** BASIC isn't the only language your Apple knows. With multi-lingual software, you can learn to speak Spanish, French, Russian, and even Chinese and Japanese, like a native!

▶ **Advance Your Career With Computer-Aided Training** Need to learn spreadsheet analysis, accounting or word processing? You can learn these skills on your own with your Apple and new interactive software. It's the fastest and easiest way to get ahead!

▶ **Manage Your Finances Like a Pro** Our monthly column "Money Matters" focuses on how your Apple can help you make, save and manage your money more effectively. You'll learn about stocks, bonds, tax shelters, real estate, home budgeting, and more!

▶ **PLUS** you can enlist your Apple to: create attractive reports with graphics... improve interpersonal skills... print in color *without* a color printer... cope with stress more effectively... learn CPR... manage mailing lists... make your home safer... plot football strategy... access outside networks... learn auto mechanics... and much, much more!

To subscribe, call toll-free
800-852-5200

or use the attached order card and tell us how much you want to save on **A+**:
20%—1 year only \$19.97
26%—2 years only \$36.97
A+, The Magazine Apple Users Turn to for New Applications

PKASO/U®

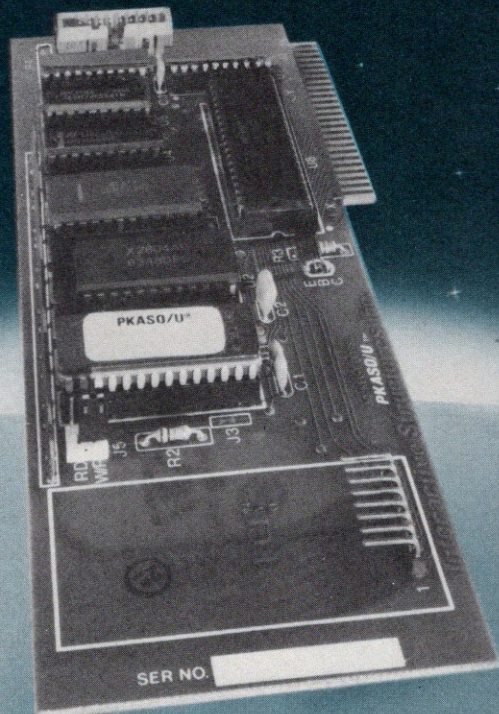

The Universal Printer Interface

Apple II, IIe, III and Apple compatible.

- Universal for virtually all standard parallel printers.
- Famous for Graphics (LoRes, HiRes, SuperRes) (Logo Compatible)
- Terrific for text (even rotates spreadsheets to print sideways)

One set of commands for all printers. One command changes character sizes. Create your own printing fonts, alphabets and symbols . . . bold face, underline, italics, subscript and superscript, HiRes Zooming.



PLUS:

FREE Utility and Demonstration Software Disk. CLEAR, comprehensive user documentation. PKASO/U . . . for all the reasons you need an interface.

Contact us for a list of Authorized Dealers near you.



Interactive Structures, Inc.
146 Montgomery Avenue
Bala Cynwyd, PA 19004
Telephone: (215) 667-1713

memory on the 80-column text card for "disk" storage. It is called a RAMdisk or an electronic disk, and its contents will vanish when you turn the Apple off.

RENAME VOLUME

This command allows you to specify a new name for the volume directory on a disk. You may want to do this if you have inadvertently given two different disks the same name.

DETECT BAD BLOCKS

This command scans all the blocks on a disk and displays (and prints, if you have enabled printer output) the number of each unreadable block. A block will be unreadable if the disk has been physically damaged or if the disk-drive door is open.

After detection of three bad blocks, you can cancel the DETECT BAD BLOCKS command by pressing Escape or continue by pressing Return. If you press Return, you won't be able to terminate the command prematurely.

If the command doesn't detect any bad blocks, the message 0 BAD BLOCKS will appear.

BLOCK ALLOCATION

This command examines the disk in a given slot and drive and displays the number of blocks in use on the disk (blocks are for file storage and ProDOS reserved areas), the number of free blocks on the disk, and the total number of blocks on the disk.

For example, if 98 blocks are in use on a standard 5¼-inch floppy disk, the BLOCK ALLOCATION command will display the following results:

```
98 BLOCKS USED
182 BLOCKS FREE
280 BLOCKS TOTAL
```

Note that you get a display of this same information, in a slightly different format, when you use the BASIC.SYSTEM CATALOG command to list the disk directory.

COMPARE VOLUMES

If you're prudent, you are probably used to making backup copies of your program and data disks so that if your original is damaged, you can recover quickly.

You should make a new backup copy of an original disk shortly after you change the data on the original in any way. If you can't remember whether you've made any changes since the last backup, the COMPARE VOLUMES command should come in handy.

COMPARE VOLUMES does a block-for-block comparison of two disks and displays (and prints, if the printer is enabled) the numbers of any blocks that are different. After detection of three discrepancies, you can cancel the command by pressing Escape or continue by pressing Return. If you continue, you can't interrupt the comparison operation until all the blocks have been checked.

If the disks are identical, the message COMPARE COMPLETE will be displayed.

THE FILE COMMANDS

The file commands let you easily perform several useful maintenance operations on files: copying, deleting, renaming, locking, and so on. You can also control many of these operations by using the BASIC.SYSTEM commands that we looked at in June and July.

The main advantage of using FILER instead, however, is that you can have *groups of files* acted on at the same time by specifying filenames that include one of two wildcard characters: ? or =. When FILER encounters a name



THE BETTER LETTER BOX

Introducing EasyPlex™. The new, easy-to-use electronic mail system from CompuServe.

Finally! Electronic Mail that's so easy to use you can start composing and sending messages the first time you get online.

Designed for various experience levels, EasyPlex has a menu mode with simple, easy-to-follow directions for beginners, and it lets experienced users save time by working in the prompt or command modes. With EasyPlex, you can compose, edit, send, file, and take advantage of sophisticated

options previously available only with more expensive services.

CompuServe's EasyPlex lets friends and relatives, associations and club members communicate any time of the day or night. And small business owners, real estate professionals, insurance agents, lawyers, writers, etc. can communicate quickly and simply—either interoffice or interstate. "It's Easy." "Just Plex it!"

Best of all, EasyPlex is available to all CompuServe subscribers. And, along with EasyPlex, you get hundreds of valuable and entertaining computing options. Plus the assurance of belonging to the largest, fastest

growing computer information service in the world and the premier supplier of business information to FORTUNE 500 companies.

Start communicating! To buy a CompuServe Subscription Kit, see your nearest computer dealer. To receive our informative brochure or to order direct, call or write:

CompuServe®

Information Services, P.O. Box 20212
5000 Arlington Centre Blvd., Columbus, Ohio 43220

800-848-8199

In Ohio, call 614-457-0802

An H&R Block Company

CIRCLE 271 ON READER SERVICE CARD

Quadram Enhances Apples!

Quadram expands the power of the Apple II series personal computers. Quadram set the standard with the Quadboard. Now we offer you Multicore, the card that delivers RAM expansion to 256K, parallel and serial ports, a ProDOS clock/calendar, and RAM drive software. Plus, there's the new Extended Multifunction Card, Clock/Calendar Card, Serial Interface Adapter, and Buffered Serial Interface Adapter. All designed to bring out the best your Apple has to offer. For further details on these cards as well as our popular APIC parallel interface and eRAM 80 cards visit the dealer nearest you, or contact us at 4355 International Blvd., Norcross, Georgia 30093 (404) 923-6666.

Multicore by Quadram

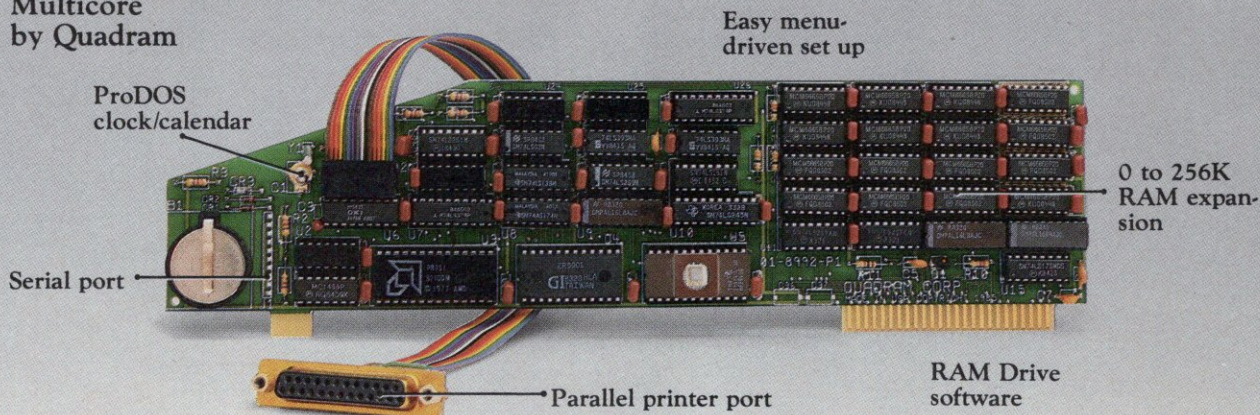

Pro-DOS Clock/calendar

Long-life Lithium battery • Easy to use date/time software.



Extended Multifunction Card

80-column extension for Apple IIe
 • 64K RAM expansion option • Color RGB interface • ProDOS clock/calendar.

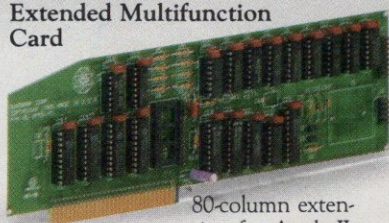

Serial Interface Adapter

Serial printer or communications interface • Supports graphics for Apple Imagewriter and Scribe printers
 • Apple Super Serial Card compatibility
 • Easy "switchless" serial configuration.



Buffered Serial Interface Adapter

Serial printer or communications interface • Supports graphics for Apple Imagewriter and Scribe printers, including color and hires • Hardware print buffer with 64K to 256K RAM • Easy "switchless" serial configuration.



Apple, Apple II, IIe, II+ are trademarks of Apple Computer Corp.

QUADRAM  TM
 An Intelligent Systems Company

CIRCLE 139 ON READER SERVICE CARD

with a wild-card character, all files whose names begin with the character(s) before the wild card and end with the character(s) after it will be dealt with together.

For example, if you specify the name B?D or B=D, FILER will act on files with the name BAD or BEDAZZLED or any other file whose name begins with B and ends with D. If you specify just ? or = as the filename, all files will be selected.

The one major difference between the two wild-card characters is that if you use ?, the message

FOR EACH FILE, ENTER (Y/N) OR < ESC >

appears when the command starts to run. Then, when FILER finds a matching filename, it displays it, and you have to press Y to confirm that the file operation is to be performed on that file or N if it isn't. On the other hand, if you use =, FILER deals with all matching files without prompting you.

In contrast to the situation with volume commands, you cannot specify disk volumes by slot and drive numbers when you use the file commands. You have to use prefixes and pathnames instead.

Let's look at each of the eight main file commands now (we'll ignore the self-explanatory TUTOR command).

LIST PRODOS DIRECTORY

You use this command to display a list of the names of all the files stored in the specified disk directory. Just enter the = wild card instead of a specific filename. (Note that you cannot mix this wild card with other characters.)

The format for displaying each file entry looks something like this:

BASIC.SYSTEM SYS 2 1 18-JUN-84

where the number after the filename and the file-type mnemonic shows the size of the file (in blocks) and the date is the date of the last file modification. This format is the same one the BASIC.SYSTEM CAT command uses.

The ProDOS directory listing will also go to the printer if you have enabled printer output with the CONFIGURATION DEFAULTS command in FILER's opening menu.

COPY FILES

This command is for transferring a file or—with wild cards—a group of files from one disk to another. For example, to transfer all files whose names end in .AW from the /WORDPRO disk volume to the /BACKUP volume, specify that the transfer is from /WORDPRO/= .AW and that it is moving to /BACKUP/= .AW. If you want a prompt to confirm the transfer of each matching file before it occurs, use the ? wild card instead of =.

If the destination disk already has a file with the same name as the one you're copying, you will see the message

DELETE EXISTING FILE? (Y/N)

If you want to overwrite the existing file, just answer by pressing Y. If you press N instead, the file will not copy.

DELETE FILES

This command works just like the BASIC.SYSTEM DELETE command, except that you can specify wild-card filenames as well. For example, to delete all files in the prefix directory, with prompting, specify ? as the filename.

COMPARE FILES

This command is for doing a block-for-block comparison of two files to see if they are the same. If they are not, you'll get the message FILES DO NOT MATCH. You

Software Discounters of America (& Peripherals, too!)

Orders Outside PA—1-800-225-7638

PA Orders — 1-800-223-7784

Customer Service 412-361-5291

- Free Shipping on orders over \$100 in continental USA
- No surcharge for VISA/Mastercard
- Your card is not charged until we ship



ARTWORX	FISHER PRICE	SCARBOROUGH
Bridge 4.0 \$16	Alpha Build \$16	Boston Computer Diet \$49
Strip Poker \$21	Logic Levels \$16	Build A Book \$26
Strip Poker (MAC) \$25	Up & Add Em \$16	Masterytype \$25
Male Data Disk \$16	HAYDEN	Masterytype (MAC) \$29
Female Data Disk \$16	Ensemble (MAC) \$179	Make Millions (MAC) \$32
AVALON HILL	Musicworks (MAC) \$49	Net Worth \$49
Beast War \$19	SAT (MAC) \$67	SIERRA ON LINE
B-1 Nuclear Bomber \$16	Sargon II \$16	Homeword \$43
Computer Stocks & Bonds \$19	Sargon III \$33	Homeword w/Speller \$67
Legionnaire \$21	Sargon III(MAC) \$33	Kings Quest (128K) \$33
T.A.C. \$26	Videoworks (MAC) \$59	Ultima II \$39
Telenguard \$19	Word Challenge II (MAC) \$25	Ultima II (MAC) \$39
Tournament Golf \$21	INFOCOM	SIMON & SCHUSTER
BLUE CHIP	Cut Throats \$25	Gonzo in Wordrider \$23
Baron \$32	Deadline \$33	Kermit's Electronic Storymaker \$23
Millionaire \$32	Enchanter \$25	NY Times Crossword Puzzles \$16
Tycoon \$32	Hitchhiker's Guide to the Galaxy \$25	Typing Tutor III \$32
These Titles Available for MAC \$37 Ea	Infidel \$29	Typing Tutor III (MAC) \$37
BRODERBUND	Planetfall \$25	SPINNAKER
Bank St. Filer (64K) \$43	Sorcerer \$29	Alphabet Zoo \$19
Bank St. Filer (128K) \$43	Suspect \$29	Counting Parade \$19
Bank St. Mailer (64K) \$43	Wishbringer \$25	Facemaker \$17
Bank St. Mailer (128K) \$43	Witness \$25	Fraction Fever \$17
Bank St. Writer (64K) \$43	Zork I \$25	Kidwriter \$19
Bank St. Writer (128K) \$43	* All titles available for Macintosh at prices listed above	Kids on Keys \$17
Bank St. Speller \$43	KOALA	Kinder Comp \$17
Carmen Sandiego \$25	Gibson Light Pen \$149	Story Machine \$17
Dazzle Draw (128K) \$39	Muppet Learning Keys (Ile & Ilc) \$49	Trains \$19
Karateka \$23	MacVision \$229	SPRINGBOARD
Loderunner (MAC) \$23	LEARNING COMPANY	Early Games \$23
Print Shop \$31	Addition Magician \$23	Easy as ABC \$25
Print Shop Graphics Library Disk #1 \$17	Gertrudes Secrets \$27	Fraction Factory \$19
Print Shop Graphics Library Disk #2 \$17	Juggles Rainbow \$19	Mask Parade \$25
Science Tool Kit \$39	Number Stumper \$25	Newsroom \$33
CBS	Reader Rabbit \$25	Newsroom Click Art Template \$19
Algebra Series Call	Robot Odyssey I \$33	Stickers \$23
Charles Goren Bridge \$49	Word Spinner \$23	SSI
Dinosaur Dig \$25	MICROLAB	Battle Normandy \$25
Dr. Seuss Puzzler \$21	Death in Caribbean \$23	Carrier Force \$39
Felony \$21	Dino Eggs \$16	Computer Ambush \$39
Mastering the SAT \$67	Short Circuit \$16	Computer Baseball \$25
Math Series Call	MICROPROSE	Computer QB \$25
Murder by Dozen \$23	F-15 Strike Eagle \$23	Galactic Adventures \$39
CONTINENTAL	Nato Commander \$23	Gemstone Warrior \$23
Book of Adv. Games \$16	Solo Flight \$23	Germany 1985 \$39
Home Accountant \$44	MINDSCAPE	Kampfgruppe \$39
Home Accountant (128 K Ile & Ilc) \$44	Bank St. Story Book \$26	Phantasia \$25
Home Accountant (MAC) Call	Crossword Magic \$33	Pro Tour Golf \$25
DATASOFT	Mr. Pixel's Cartoon Kit \$23	Questron \$33
Bruce Lee \$23	Mr. Pixel's Programming Paint Set \$23	Rails West \$25
Conan \$25	MONOGRAM	War In Russia \$49
Dallas Quest \$21	Dollars & Sense \$59	SUBLOGIC
Mr. Do \$25	Dollars & Sense (Ilc) \$74	Flight Simulator II \$32
Pac Man \$17	Dollars & Sense(MAC) \$95	TELARIUM
DAVIDSON	MUSE	Amazon \$25
Math Blaster \$32	Beyond Wolfenstein \$23	Fahrenheit 451 \$25
Speed Reader II \$43	Castle Wolfenstein \$19	Rendezvous w/Rama \$25
Speed Reader II (MAC) \$43	ORIGIN	TIMEWORKS
Spell It \$32	Ultima II \$39	Evelyn Wood \$44
Word Attack \$32	PRACTICORP	Dynamic Reader \$44
ELECTRONIC ARTS	Practical II \$35	WEEKLY READER
Archon II \$27	PROFESSIONAL SOFTWARE	Sticky Bear ABC \$25
Cut & Paste WP \$35	Trivia Fever \$23	Sticky Bear Math \$25
Financial Cookbook \$35	Trivia Fever (MAC) \$25	Sticky Bear Reading \$25
Music Construction Set \$27	Trivia Fever \$25	ACCESSORIES
One-on-One \$27	Super Sports \$19	BASF SS.DD \$12Bx
Pinball Construction Set \$27	RANDOM HOUSE	BASF DS.DD \$17Bx
Seven Cities of Gold \$27	Alpine Encounter \$25	CompuServe Starter kit (5 hrs.) \$19
EPYX	Charlie Brown's ABC's \$25	Disk Case (Holds 50) \$9
Impossible Mission \$23	Peanuts Maze \$25	Disk Drive Cleaner \$9
Pitstop II \$25	Marathon \$25	Dow Jones News Retrieval Kit (5 hrs.) \$19
Summer Games II \$25	Snoopy's Reading Machine \$25	Rana Elite One Cheap
Temple of Apsah \$19		Sakata 13" Color Monitor \$169
		Total 300 Baud Modern W/ASCII Express \$79

P.O. Box 278-DEPT AP-WILDWOOD, PA 15091

*Ordering and Terms: Orders with cashier check or money order shipped immediately. Personal/company checks, allow 3 weeks clearance. No C.O.D.'s. Shipping: Continental U.S.A.—Orders under \$100 add \$3; free shipping on orders over \$100. PA residents add 6% sales tax. AK, HI, FPO-APO—add \$5 on all orders. Sorry—no International orders. Defective merchandise will be replaced with same merchandise. Other returns subject to a 15% restocking charge—NO CREDITS! Return must have authorization number (412) 361-5291.

BURIED IN STACKS OF ARTICLES? CONSIDER HIRING A LIBRARIAN FOR ONLY

\$ 75

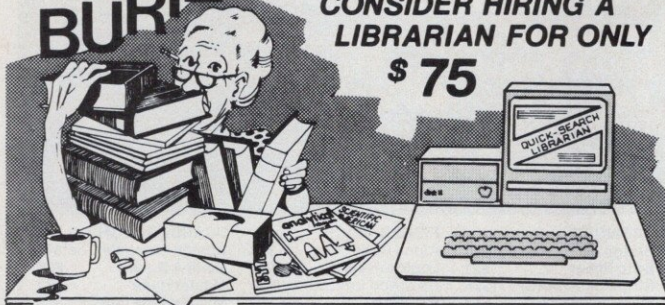

Quick Search Librarian (QSL) makes it easy to enter and edit your journal references, search for articles, and print or sort a list of articles using the APPLE* II+ /Ile computer. Important QSL features include:

- Two keystrokes select any one of 255 keywords or any one of 255 journal titles.
- Four lines available for listing authors, title and/or comments.
- Powerful data base screen editing, copying and merging features.
- Average search speed is 50 articles/second with multiple criteria; average sorting speed is 40 articles/second when sorting on 3 fields.
- Typically, 1000 articles can be stored on a single disk.
- Includes sample data base and tutorial for *Scientific American* magazine.

VISA or Mastercard orders accepted. QSL manual available separately for \$5. (Price of manual deductible later with purchase of QSL software.) Add \$2.50 for shipments made in U.S.A. Telex: 705250 *Trademark of Apple Computer, Inc.



INTERACTIVE MICROWARE, INC.
P.O. Box 139, Dept. 209
State College, PA 16804, (814) 238-8294

CIRCLE 144 ON READER SERVICE CARD

Professional Handicapping Systems



by Professor Jones

GLD. Thoroughbred "Gold" Edition™

A "Full" featured thoroughbred analysis designed for the professional and serious novice. **\$159.95** complete

EGLD. Enhanced "Gold" Edition™

"Gold" Edition with complete Master Bettor™ system integrated onto the same disk. This powerful program will transfer all horses and scores to the bet analysis with a "single keystroke." (Master Bettor™ included) **\$199.95** complete

GLTD. Limited "Gold"™

Enables Professional Handicappers to assign specific values to the racing variables "they" feel are important. Create program weight based on a particular track and fine tune it for maximum win percentage. This program is designed for "ease of use". The user needs **no programming experience.** (contains Integrated Bettor™) **\$299.95** complete

GD. Gold Dog Analysis™

The only professional dog handicapper on the market, includes:

- | | | |
|---------------|--------------|-------------------------------|
| 1) Speed | 4) Post Last | 7) Running Style |
| 2) Post Today | 5) Distance | 8) Weight |
| 3) Kennel | 6) Condition | 9) All new internal weighting |
| | | 10) NEW class indicator |

If you are near a greyhound track, you can't afford not to use this program.

\$149.95 complete (with integrated Master Bettor™) **\$199.95**
Limited Dog™ \$299.95

PPX. Professor Jones' Football Predictor, Prof. Pix™

Complete Football Analysis with Data-Base.

- | | | |
|------------------|----------------------|----------------------|
| 1) Overlays | 3) "Super Plays" | 5) Data Base Stats |
| 2) Point Spreads | 4) "Over/Under" bets | 6) Holds "100" teams |

Highest percentage of winners 1984
\$49.95 complete **\$99.95** with Data Base Management

MHH. Master Harness Handicapper™

Professional software designed to provide a thorough analysis of all trotter and pacer races in North America and Canada.

\$159.95 complete with integrated Master Bettor™ **\$199.95**

NBA. Basketball™

This data base managed analysis will provide the user with "ALL" betting situations while storing relevant information on the disk.

\$99.95 complete w/Manual **\$129.95** NBA/College Version

LOT. LOTTERY ANALYSIS™

Statistical comparison program designed to detect subtle patterns in winning lottery number.

\$79.95 complete w/Manual **\$99.95** with Lotto

IBM™
APPLE™
TRS-80™
CPM™
COMMODORE™

Prof. Jones
1940 W. State St.
Boise, ID 83702



48 HR. FREE SHIPPING

CALL 208-342-6939

TERMS: FREE SHIPPING ALL SOFTWARE. Add \$6.00 hardware / \$6.00 C.O.D. / UPS Blue \$6.00 / Out of Country \$9.00 / ID Residents 4% / 3 weeks personal checks / Cash price only, add 2% Visa, MC / Prices subject to change.

BROCHURE AVAILABLE

CIRCLE 148 ON READER SERVICE CARD

cannot use wild-card filenames with the COMPARE FILES command.

ALTER WRITE PROTECTION

This command either locks or unlocks a file or a group of files. You may recall from the June article that locked files are protected in that no one alter or delete them unless they first unlock them. You can label them with an asterisk that appears to the left of the filename when you list the directory with the BASIC.SYSTEM CATALOG command.

After you enter the filename, FILER asks you

LOCK FILES? (Y/N)

If you press Y, the file will be locked; if you press N, it will be unlocked.

RENAME FILES

This command lets you change the name of any file. The only restriction is that the new name must refer to a file in the same directory as the original.

MAKE DIRECTORY

This command is for creating a new subdirectory on a ProDOS disk, and it works much like the BASIC.SYS-

▶ If you're prudent, you are probably used to making backup copies. You should make a new backup copy of an original disk shortly after you change the data on the original in any way.

TEM CREATE command. The file-type mnemonic for the resultant directory file is DIR.

SET PREFIX

This command allows you to enter a pathname prefix—a series of directory names separated by slashes—that the other file commands will use. FILER automatically appends to the current prefix any filename or partial pathname that you specify when using a file command, in order to create the full pathname that ProDOS requires.

If the prefix that you provide is not preceded by a slash, FILER creates a prefix by appending the newly specified prefix to the current prefix. The currently active prefix always shows at the top of the screen when you enter a file command.

The effect of the SET PREFIX command is the same as that of the BASIC.SYSTEM PREFIX command.

Preview

Next month will be the grand finale. We will discuss the CONVERT program, which you can use to transfer programs and files between DOS 3.3- and ProDOS-formatted disks. Then, we'll finish up with an introduction to the MLI (machine-language interface) subroutines, which assembly-language programs can call to perform standard disk operations. **+**

Gary B. Little is a writer from Vancouver, British Columbia. His latest book is a detailed study of the internal structure of ProDOS: Apple ProDOS, Advanced Features for Programmers (1985, Brady Communications). He is also the author of the Modem Magician telecommunications program.

EASTCOAST SOFTWARE

ecs...inflation-fighting prices.

No hidden charges! No credit card fees!

APPLE

CAT #	LIST	OUR PRICE
2413	ADVENT WRITER W/GRAPHICS	50.00 28.85
2104	AGENT USA	39.95 25.65
0560	ALGEBRA 1	39.95 24.80
1142	ALIEN ADDITION	34.00 23.05
0013	ALPHA PLOT	39.50 25.35
2598	ALPHABET ZOO	29.95 20.30
0151	APPLE MECHANIC	29.50 18.95
0025	APPLE SOFTWARE 1985	19.95 15.45
0536	ASSEMBLY LINES (BOOK)	19.95 15.35
1448	BACK TO BASICS ACCT 2E/2C	195.00 125.00
1204	BANK ST. WRITER 2C/E-128K	69.95 44.85
1685	BANK STREET FILER	69.95 44.85
1405	BANK STREET STORYBOOK	39.95 25.65
0211	BARRON'S COMPUTER SAT	89.95 60.90
0278	BEAGLE BAG	29.50 18.95
0126	BEAGLE BASIC	34.95 22.45
1192	BEAGLE GRAPHICS	59.95 38.45
0658	BENEATH APPLE DOS	19.95 14.95
1385	BENEATH APPLE PRODOS	19.95 14.95
1375	BPI GENERAL ACCOUNTING //E	395.00 253.25
2194	BUILD A BOOK	39.95 27.05
0448	BUMBLE GAMES	39.95 25.65
2880	C.H. PRODUCT MACH 3 (2E/C)	54.95 35.25
2816	C.H. PRODUCTS MACH 2	44.95 28.85
2817	C.H. PRODUCTS MACH 2E/2C	44.95 28.85
2883	C.H. PRODUCTS MACH 3	54.95 35.25
1417	CHARLIE BROWN'S ABC'S	39.95 25.60
1432	CODEWRITER	140.00 80.75
0416	COMPUSERVE STARTER KIT	39.95 24.35
1138	COMPUTER SAT (HARCOURT)	79.95 51.25
1731	COPY 2 PLUS 5.0	39.95 20.50
1468	CRICKET 2C	179.95 115.30
2097	CROSSWORD MAGIC	49.95 32.05
1900	D-CODE	39.95 25.65
1645	DAZZLE DRAW-2C/2E (128K)	59.95 38.40
1265	DB MASTER PLUS	295.00 189.10
0052	DEADLINE	49.95 32.05
0630	DELTA DRAWING	39.95 25.65
1143	DEMOLITION DIVISION	34.00 23.05
1539	DISK 3-RING VINYL PAGES-10	6.75 4.10
1166	DISK BANK (50)	19.95 11.00
1722	DISK BOXES (5 COLOR CODED)	19.95 12.70
2866	DISK DRIVE EXTENSION CABLE	19.75 16.70
2833	DISK QUIK	29.50 18.95
1205	DOLLARS & SENSE-2C	119.95 76.90
0409	DOLLARS & SENSE	100.00 64.10
0216	DOS BOSS	24.00 15.30
0983	DOUBLE TAKE	34.95 22.45
2205	DUST COVER - IMAGEWRITER	10.00 7.15
2285	DUST COVER EPSON RX 80	7.99 5.75
2028	DUST COVER MICROLINE 92	8.95 6.40
1760	DUSTCOVER-APPKYBOARD-2 + /E	7.99 5.75
0360	EARLY GAMES YOUNG CHILDREN	34.95 22.45
1377	ECHO 2+ SPEECH SYNTH.	149.95 109.00
0092	ELEPHANT DISKS SS/DD (10)	37.00 14.75
1337	ELEPHANT DISKS SS/SD (10)	34.00 14.10
0107	EPSON MX-80 RIBBON	14.00 6.30
0229	ESSENTIAL DATA DUPLICATOR	79.95 49.95
0238	EXTRA K	39.95 25.65
0732	F15 STRIKE EAGLE	34.95 22.45
0280	FACEMAKER	24.95 16.00
1113	FAHRENHEIT 451	39.95 27.15
2986	FANTASY	39.95 25.65
1126	FIGURES AND FORMULAS	29.95 19.25
0850	FLASCALC (PRO DOS)	99.00 67.05
0553	FLEX TYPE (FLEX TEXT)	29.50 18.95
2821	FLIGHT SIMULATOR II	49.95 35.25
1440	FLIP-N-FILE (50 DISKS)	19.95 11.30
2796	FONTRIX	75.00 48.75
0009	FORECAST	59.95 40.60
0554	FRAME-UP	29.50 18.95

CAT #	LIST	OUR PRICE
1127	GAME SHOW	39.95 27.05
0733	GEMSTONE WARRIOR	34.95 25.55
0046	GENERAL MANAGER II	229.95 147.45
0573	GERTRUDE'S PUZZLES	44.95 30.45
2213	GHOST BUSTERS	39.95 27.05
2843	GLOBAL PLE/BEAGLE BROS	49.95 32.05
1100	GRANDMA'S HOUSE	24.95 16.00
0043	GRAPHICS MAGICIAN	59.95 38.45
0094	GRAPPLER +	119.00 87.30
0028	GUIDE TO THE APPLE //C	12.95 10.00
1346	HITCHHIKERS GUIDE GALAXY	39.95 25.65
1364	HOME ACCOUNTANT 2C/E-128K	74.95 48.05
2804	HOMEWORD	69.95 44.85
1901	I.O. SILVER	29.95 19.25
1589	IN SEARCH OF AMAZING THING	32.95 21.15
0442	JENNY OF THE PRAIRIE	39.95 27.05
0449	JUGGLES RAINBOW	29.95 19.25
2671	KAMELEON 2C INTERFACE	99.95 65.75
1671	KARATEKA	34.95 22.45
1442	KINDERCOMP	24.95 16.00
1144	KING'S QUEST	49.95 32.05
0003	KNIGHT OF DIAMONDS	34.95 22.45
1693	KOALA GRAPH TABLET-2E/2C	124.95 85.25
2954	KRELL LOGO	99.95 76.95
2972	LABELS 1-IN WHITE (1000)	8.95 6.75
2890	LEARNING BRIDGE MADE EASY	79.95 54.15
1463	LEGACY OF LYL/GAMYN	39.95 25.65
0403	LISA 2.6	79.95 61.55
0806	LOCKSMITH 5.0	99.95 65.85
1708	LODE RUNNER CHAMPION-HINTS	9.95 6.30
0982	LODE RUNNER	34.95 22.45
3094	MAGIC WINDOW 2E/2C	149.95 94.90
0192	MASTER TYPE	39.95 25.65
0089	MAXELL SS/DD DISKS (10)	38.70 18.60
2357	MEGAWORKS (2E/2C)	125.00 84.65
0227	MICRO COOKBOOK //C	40.00 25.65
2148	MICRO COOKBOOK //E	40.00 25.65
1294	MICRO-SCI 2C DISK DRIVE	299.00 248.75
1316	MICRO-SCI 4C DISK DRIVE	345.00 216.65
1509	MICROLINE RIBBON	3.20 2.20
2802	MICROMODEM 2E W/SMARTCOM I	199.00 153.85
1347	MILLIONAIRE	49.95 33.85
1135	MINUS MISSION	34.00 23.05
0774	MOCKINGBOARD C W/SPEECH	179.00 137.70
1400	MOPTOWN HOTEL	39.95 25.60
1709	MR. PRINTER STAND	29.95 20.30
0580	MULTIPLAN (APPLE DOS)	95.00 64.35
0191	NEWSROOM	49.95 32.05
2987	OPERATION MARKET GARDEN	49.95 32.05
0563	PADDLE-ADAPPLICE COMBO	29.95 26.90
0568	PAPER GRAPHICS	49.95 32.05
2893	PARAL PRINTER EXT CABLE 6'	34.95 21.80
0635	PARALLEL INTERFACE W/CABLE	69.95 52.55
1418	PEANUTS PICTURE PUZZLERS	39.95 25.60
0088	PFS ACCESS-2E/2C	70.00 44.80
1413	PFS FILE //E	125.00 80.15
1415	PFS GRAPH //E	125.00 80.15
1414	PFS REPORT //E	125.00 80.15
2809	PFS WRITE //E	125.00 80.15
0495	PIE WRITER 2.2 (40/80)	149.95 96.15
0584	PRESCHOOL IQ BUILDER 1	24.95 16.90
1196	PRINT SHOP	49.95 32.05
1793	PRINTSHOP GRAPHICS 3	24.95 16.00
0256	PRINTSHOP PAPER PACK	19.95 12.70
0349	PRO BLACKJACK - K. USTON	69.95 47.35
2236	PRO BYTER	34.95 22.40
0461	PRONTO DOS	29.50 18.95
1279	PROWRITER NYLON RIBBON	10.00 6.65
0047	QUEST	34.95 22.45
2111	RAMCARD 16K-MPC	99.00 60.25
1386	RAMCARD 16K-WIZARD	96.00 62.85
2309	RAMWORKS/64K	179.00 149.15
0771	RF MODULATOR-INTERNAL	39.00 17.40
1450	RHYMES & RIDDLES	24.95 16.00
0574	ROCKY'S BOOTS	49.95 32.05
0133	SCREENWRITER II	129.95 83.35
0041	SENSIBLE SPELLER IV	125.00 80.15
1206	SENSIBLE SPELLER-PRO DOS	125.00 80.15
0447	SIDEWAYS	60.00 38.40
0400	SILICON SALAD	24.95 16.00
1340	SKY FOX	40.00 28.50
1373	SMARTMODEM 2C W/SMARTCOM I	239.00 180.80
0465	SNOOPER TROOPS 1	32.95 21.15
1338	SNOOPY'S READING MACHINE	39.95 25.65
0250	SPELLAGRAPH	39.95 25.65
1291	SPELLICOPTER	39.95 25.65
0435	STEP-BY-STEP	99.95 67.65
0100	STICKY BEAR A B C	39.95 25.60
0099	STICKY BEAR NUMBERS	39.95 27.05
0292	STORY MACHINE	24.95 16.00
1326	SUNDOG	40.00 30.75
0001	SYSTEM SAVER	89.95 69.20
0236	TERRAPIN LOGO	99.95 67.65
1330	TG JOYSTICK W/Toggle //E	29.95 20.30
1598	THE FACTORY (HOME)	44.95 31.70
1602	THE POND (HOME)	44.95 31.70
0844	THINK TANK //E	150.00 96.15
2897	THUNDERCLOCK PLUS	150.00 121.80
1869	TIME IS MONEY	100.00 68.75
2899	TIME MASTER 2 H.O.	129.00 107.50
0462	TIP DISK #1	20.00 12.85
1193	TRIPLE DUMP	39.95 25.65

CAT #	LIST	OUR PRICE
1823	TURBO PASCAL (CP/M)	69.95 47.35
0544	TYPEFACES	20.00 12.85
0155	TYPING TUTOR 2	24.95 16.90
1237	TYPING TUTOR 3	49.95 33.85
2836	ULTIMA III (EXODUS)	59.95 38.45
2112	UNIVERSAL PRINTER STAND	29.95 19.25
0062	UTILITY CITY	29.50 18.95
2858	VERB VIPER	34.00 21.70
2992	VERBATIM DS/DD DISKS (10)	47.50 24.35
1721	VERBATIM SS/DD HARDPACK	35.00 23.35
0093	VERBATIM SS/DD SOFTPACK	34.50 16.40
2900	VIEWMASTER 80	139.00 115.85
2152	VISIBLE COMPUTER-6502	49.95 32.70
1864	VISCALC 2 + /2E	179.00 121.20
1480	WICO ANALOG JOYSTICK 2E	49.95 33.85
1296	WITNESS	39.95 25.65
1139	WIZARD OF WORDS	39.95 27.05
0144	WIZARDRY	49.95 32.05
2888	WORD ATTACK	49.95 32.00
1402	WORD CHALLENGE	39.95 25.65
0249	Z-80 PLUS BOARD	139.00 112.95
0305	ZOOM/MODEM //E	179.00 134.65
0296	ZORK I	39.95 25.65

SPECIALS

2904	ARCHON	40.00 28.50
2819	CHART 'N GRAPH TOOLBOX	39.95 25.65
0416	COMPUSERVE STARTER KIT	39.95 24.35
1731	COPY 2 PLUS 5.0	39.95 20.50
2910	CUT & PASTE (2E/2C)	50.00 35.65
2155	DATABASE TOOLBOX	39.95 25.65
1470	ELEPHANT DISKS DS/DD (10)	50.00 17.95
0092	ELEPHANT DISKS SS/DD (10)	37.00 14.75
0371	FINANCIAL COOKBOOK	50.00 35.65
2902	HARD HAT MACK	35.00 24.90
1654	MERLIN PRO.	99.95 64.10
0597	MERLIN	64.95 41.65
1409	MERLIN/MUNCH/ASMBLY COMBO	109.95 70.50
0910	MUNCH A BUG	39.95 25.65
1341	MURDER ON THE ZINDERNEUF	40.00 28.50
2903	MUSIC CONSTRUCTION SET	40.00 28.50
2908	ONE ON ONE	40.00 28.50
2907	PINBALL CONSTRUCT SET	40.00 28.50
0599	PRINTOGRAPHER	39.95 25.65
1340	SKY FOX	40.00 28.50
2906	STANDING STONES	40.00 28.50
0093	VERBATIM SS/DD SOFTPACK	34.50 16.40
0912	VIDEO TOOLBOX	39.95 25.65
1453	WIZARD'S TOOLBOX	39.95 25.65
1131	WRITE CHOICE	44.95 28.85

MACINTOSH

2909	BACK TO BASICS ACCT SYSTEM	375.00 232.70
0656	CHART (MAC)	125.00 84.65
2220	CHIP WITS	50.00 35.85
1223	COPY 2 MAC VERSION 3.0	39.95 20.50
1514	DB MASTER	195.00 132.00
1151	DOLLARS & SENSE	149.95 96.15
2203	DUST COVER-MAC & KEYBOARD	20.00 14.30
3160	ELECTRIC CHECKBOOK	79.95 54.15
1219	ENSEMBLE	300.00 203.05
1362	FINANCIAL COOKBOOK	50.00 35.65
1324	FIRST BASE	195.00 132.00
3500	FLIP-N-FILE (60)	34.95 16.45
1926	FRONT DESK	149.95 101.50
1690	HAYDENSPELLER	79.95 51.25
1083	HOME ACCOUNTANT	150.00 101.54
0650	MASTER TYPE	49.95 33.35
1411	MAXELL 3.5-IN DISKS (10)	55.00 33.35
2787	MEMOREX 3.5-IN DISKS (10)	60.00 33.35
1073	MICROSOFT WORD (MAC)	195.00 132.00
0655	MULTIPLAN (MAC)	195.00 132.00
1946	MUSIC WORKS	79.95 51.25
0668	THINK TANK (512K)	245.00 157.05
2196	THUNDERSCAN	229.00 194.90
1239	TYPING TUTOR 3	59.95 39.75
0646	VERBATIM 3.5" DISKS	78.50 32.70

CHECK ONE: VISA MASTERCARD

Card # _____ Exp. _____

Telephone _____

Name _____

Address _____

City _____

State _____ Zip _____

Please enter my order for: _____

Please specify machine: _____

Please send free catalog.

EASTCOAST SOFTWARE

49 Derrytown Mall
Hershey, PA 17033

MAIL YOUR ORDER OR CALL

(717) 533-8125

800-233-3237



VISA

We Ship UPS—Shipping 1% (\$2.50 min.)

C.O.D. Add An Additional \$2.50

Hardware (Printers/Monitors)

Shipping is \$2.50 + 4% (U.P.S.)

For Air Mail, Canadian, APO/FPO Orders,

Shipping \$2.50 + 4% of Total Order (US Funds)

PA Residents Add 6% Tax

No Minimum Order

Visa-Mastercard-C.O.D.-Check

Prices Subject To Change

Sorry, No Foreign Orders

This Ad Prepared June 1985

*** SUMMER SALE ***

APPLE* MODEMS

by Prometheus

New 300/1200 Baud 212A Telephone Modem for your Apple II, II+ and IIe. Just plug in - Hayes compatible!

PM1200A . . . \$299.95

MAC PAC

for your Macintosh

Includes: ProModem 1200 external modem, cable and software.

MAC PAC . . . \$369.95

OPTION SPECIAL!

Lowest Price!

Includes options processor, display and 64K buffer.

PM-Special . . \$169.95

Additional Apple Products

Apple Cooling Fan

for Apple II, II+ and IIe

APF-1 \$39.95

Switching Power Supply

for Apple II, II+ and IIe

KHP4007 . . . \$59.95

SALE!

12" Monochrome Green Monitor for APPLE II, II+, IIe & IIc

- Excellent resolution
- 80 character x 24 line display format
- Complete with tilt/swivel monitor stand!

MON-12G \$79.95

80-Column plus 64K RAM for your APPLE IIe*



AppleWorks* Compatible!

Now you can double the memory capacity and get an 80-column display format for your APPLE IIe* computer at an affordable price. Just plug the JE864 card into your APPLE* and expand your display to 80 characters per line. Perfect for word processing. The JE864 also features 64K bytes of additional memory to allow programming not possible with standard APPLE IIe* computers. Complete documentation included.

Board: High density board design squeezes 64K bytes of RAM onto a 2 1/2" x 4 1/2" board • Fully tested to assure proper operation.

Uses: Word processing - displays 1000 more characters per screen • Extra memory allows running of extremely large programs • Ultra High Resolution Graphics capability.

JE864 \$79.95



Serving the Computer Enthusiast Since 1974

QUALITY COMPUTER PRODUCTS FOR APPLE II, II+, IIe, IIc and Macintosh*

Com-Drive Dual 5 1/4" Floppy Disk Drive & Controller Card for Apple II, II+ and IIe

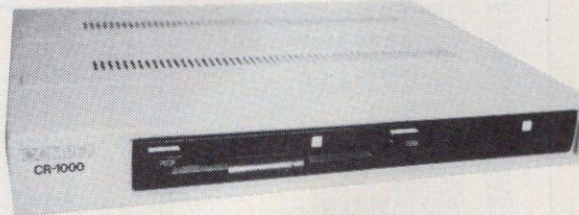

Sleek & slim. Only 55mm thick—half the size of a standard Apple* drive. 286K total formatted capacity (143K each drive): twice the space for data. A special pulse motor makes it accurate, reliable and fast. Color matches Apple Computer. Complete with connectors—just plug into the disk controller card (included).

Each ADD-1000 includes: Dual 5 1/4" disk drives, console, controller card, multi-disk filer program, and aluminum protective cover. Complete with instructions.

- No. of tracks: 35 • Seek time: 40 ms • Density: 48 TPI • Format: Single-sided, single-density • Size: 14.9"W x 2.1"H x 10.1"D • Weight: 10.1 lbs.

ADD-1000 \$219.95 ea.
or 2/\$399.95

APPLE™ Compatible 5 1/4" Disk Drive and Controller Card



- Uses Shugart SA390 mechanics
- 143K formatted storage • Color matches Apple Computer • Works with Apple Controller or other Apple-compatible controllers (ACC-1)
- Complete with connector - just plug into your disk controller card
- 35 tracks • Size: 6"W x 3 1/2"H x 8-9/16"D • Wt.: 4 1/4 lbs.

ADD-514 (Disk Drive) \$149.95

ACC-1 (Controller Card) \$49.95

APPLE™ Compatible 5 1/4" Half-Ht. Disk Drive



- Uses Chiron Pinch-type mechanics
- 143K formatted • 35 tracks • Super quiet • Works with Apple Controllers or other compatibles (ACC-1) above
- Complete with connector - just plug into your controller • Size: 5 1/4"W x 1 3/8"H x 8"D • Wt.: 4 lbs.

ADD-12 . . . \$129.95

APPLE™ IIc Compatible 5 1/4" Half-Ht. Disk Drive

- Same specs as ADD-12 (above) except no controller necessary

ADD-IIc. **NEW!** \$129.95

APPLE Keyboard and Case for Apple II and II+*



KEYBOARD (KB-A68):

- 68 Keys • 15-Key Keypad • Direct connection with 16-pin ribbon connector • Special functions on number keys, including cursor controls, color demo, and one-touch disk catalog • Metal baseplate for durability (with 6 mounting holes) • Color (keys): white/grey • Size: 14 1/2"L x 5 1/2"W x 1 1/2"H

CASE (EAEC-1):

- Accommodates KB-A68 • Pop-up lid for easy access • Fits power supply and motherboard too • Size: 15 1/2"W x 18"D x 4 1/4"H

Part No.	Description	Price
KB-EA1	Apple Keyboard and Case	\$134.95
KB-A68	68-Key Apple Keyboard only	\$ 79.95
EAEC-1	Expanded Apple Enclosure Case only	\$ 59.95

Special Functions!

\$10.00 Min. Order - U.S. Funds Only
Calif. Residents Add 6 1/2% Sales Tax
Shipping - Add 5% plus \$1.50 Ins.
Send S.A.S.E. for Monthly Sales Flyer!

Send \$1.00 Postage for your
FREE 1985 JAMECO CATALOG
Prices Subject to Change



1355 SHOREWAY ROAD
BELMONT, CALIFORNIA 94002

Phone Orders Welcome (415) 592-8097
Telex No. 176043

8/85

APPLE* Compatible Cards

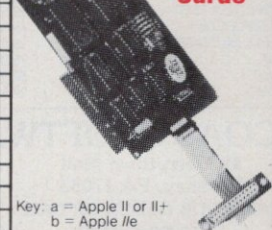

Key: a = Apple II or II+
b = Apple IIe

16K RAM Card
ARC-16K (a) \$39.95

Z-80 CP/M Card
AZ80-1 (a,b) \$49.95

80-Column Card with Soft Switch
A80-C (a) \$74.95

Super Serial Card
ASSC-P (a,b) \$99.95

Printer Card with 64K
APC-64K (a,b) . . . \$129.95

*APPLE, APPLE II, II+, IIe, IIc and Macintosh are registered trademarks of APPLE Computers
**VisiCalc is a registered trademark of Visi Corp. Inc.
***Videx is a registered trademark of Videx Inc.

TELECOMMUNICATIONS BY RUSS LOCKWOOD

Federal news, bawdy
bedfellows, and BBSs

MODEM MISSIVE

When you want news about the U.S. government, where do you turn? What source do you use to gather up-to-the-minute information about national issues?

You could try nightly network television newscasts. With only 30 minutes of air time and a sizable government, however, you are lucky to see where the president traveled that day, much less find out about the policies and activities of various agencies.

You might try the radio, but five minutes at the top of the hour hardly provides you with much information. The all-news-format stations are better, but, again, they cover only the "top" stories.

Newspapers? You are certainly getting closer. On occasion, national newspapers carry the full text of politicians' speeches. Sometimes, on your truly lucky days, buried at the bottom of a page next to an ad for punk-rock fashions, you find a small tidbit of information that is more important to you than the column inches it occupies, if it is less than a day old.

What is left, you ask. The answer: Telecommunications. ITT, the same corporation that runs the Dialcom electronic-mail network, now offers Fednews—up-to-the-minute U.S. government-inspected and -issued news, available instantly via your Apple and a modem.

Fednews

Fednews grew out of the White House News Service (WHNS), a smaller telecommunications service started in November 1984 to "allow timely distribution of important news to those media which do not have a representative based directly at the White House," according to Merrie



Spaeth of the White House Office of Media Relations.

The WHNS transmits official and unedited news releases, statements, the full text of presidential speeches, personnel appointments, announcements of new legislation, and other news from the White House Press Office, the First

Fednews, available to anyone with an Apple and a modem, enables users to put the new back in news.

Lady's Office, the Office of the Vice President, and the Office of Management and Budget. All of the above are currently distributed on paper to reporters and news organizations based in Washington, D.C.

The big users of the WHNS so far are large corporations and trade associ-

ations. The service hopes to generate interest among small newspapers and radio stations that now rely on articles from the Associated Press, United Press International, and other news organizations. Anyone with a modem and computer can tie into the service.

Note that information available through the WHNS is the official line of the administration. Although presidential speeches are easy enough to understand, announcements issued in "governmentese" are often harder to comprehend. (You may remember when the White House struck the word *killing* from its vocabulary in favor of "the unlawful deprivation of life.") Even the WHNS service-agreement contract states, "Application programs and data bases are made available for Customer's assistance and convenience only and not as substitutes for Customer's analysis or judgment."

Some members of the media claim that the service was started because President Reagan has complained re-

peatedly that reporters often distort his views and misinterpret his words. Although they officially denied it, some White House aides believe that giving the president's views a direct link to newsrooms, boardrooms, and classrooms across the country will give his message a better chance of reaching the people intact.

The WHNS is but one part of Fednews, however. Other U.S. agencies offering electronic versions of their announcements and pronouncements include the Army Reserve, the Depart-

ment of Agriculture, the Food and Drug Administration, the Department of Labor, the Federal Emergency Management Agency, the Department of the Interior, and the National Aeronautics and Space Administration (NASA). These other services are updated at the discretion of the White House. Although the updates usually occur daily, the releases are stored in the database for only two weeks.

The service uses the ITT E-Pub electronic-publishing software, which allows users to search for information

with key words. Thus, if you wanted to know how Senator Garn fared on the space shuttle *Discovery*, you would use the words *Garn* and *Discovery*. The system then retrieves all stories containing those two words.

The cost is very reasonable to small newspapers and television and radio stations. Access is via Tymnet, Telenet, and direct dialing. ITT charges \$35 per hour, 24 hours per day. That means no price difference between prime and nonprime use. Fednews carries a \$25-per-month minimum.

Unfortunately, these two pricing factors combine to make the cost too steep for all but upscale computer owners. If the rates were on a par with those of CompuServe or The Source, I'd sign up in a flash just for the NASA news.

Nevertheless, the U.S. government is finally realizing the speed and efficiency of telecommunications. Fednews, because it is available to anyone with an Apple and a modem, enables users to put the *new* back in news and receive immediately all the information that is important to them.

TELETIPS

This section deals with news, views, and breakthroughs in the telecommunications world. It offers a quick overview of new features added to services we have already reviewed. I get the information by culling the numerous press releases that streak across my desk each day.

A Quartet of Studies

Link Resources, a research subsidiary of International Data Corporation, predicts electronic-mail services will lure more and more corporations into going on-line. Link estimates that, overall, electronic-mail-services revenue will grow from a mere \$80 million in 1983 to more than \$2.1 billion in 1988—an annual growth rate of 107%.

Link contends that the fastest-growing group will be mixed-mode services, which offer both terminal-to-terminal and hard-copy courier delivery of messages. Revenue estimates are \$22 million in 1984 to \$100 million in 1985 to \$800 million in 1988. Companies offering this service include MCI Mail, Federal Express ZapMail, and Western Union Easylink.

Electronic Services Unlimited has released a 100-page study called *Telecommuting: Demographics, Profiles, and Projections* that looks at the growing trend in corporate America to encourage some employees to do part of their work at home. The report claims that from 10 to 15 million people will

TravelMaster Cases: Two Good For Your IIC.

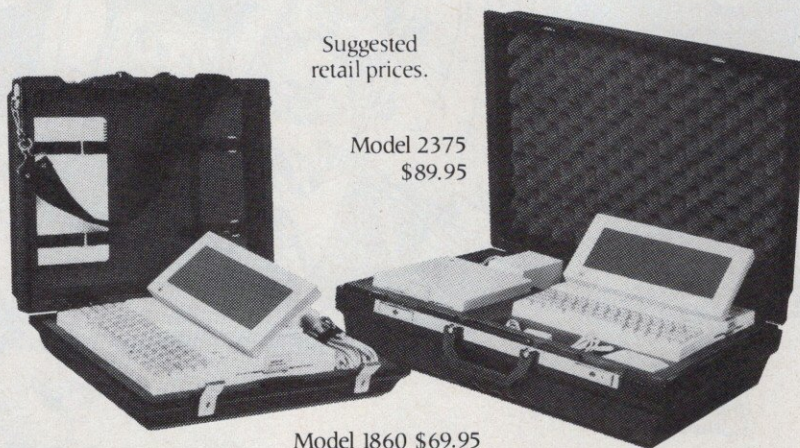

Suggested
retail prices.

Model 2375
\$89.95

Model 1860 \$69.95

The last thing you want to worry about is your new Apple IIc taking a lot of licks, whether it's by your side in the car, under the seat on the plane or just moving from class to class.

Enter TravelMaster, from Southern Case.

The double-wall polyethylene case that incorporates high density thick foam padding, a cushioning layer of trapped air for extra support and sleek locking latches that open when you want, not before.

And TravelMaster's two models, designed specifically for the Apple IIc, accommodate your entire system. The 1860 case comfortably nests your IIc keyboard, the new LCD flat screen, modem, power supply and all related cables. For a larger system, our 2375 model holds your additional disk drive and mouse unit, as well.

Call us toll-free today. Because now your new Apple IIc not only has it good, it has it two good.



TravelMaster®

THE HIGH TECH, LOW COST
HARD SIDE CASE

CALL TOLL FREE
1-800-334-0551
in NC, call 919-821-0877

Southern Case, Inc.
PO Box 28147
Raleigh, NC 27611



Allow 2-4 weeks for delivery.

CIRCLE 120 ON READER SERVICE CARD

If You Have
APPLEWORKS™
 It's Easy To Tell If You
 Have A Timemaster H.O. Clock
 In Your Apple

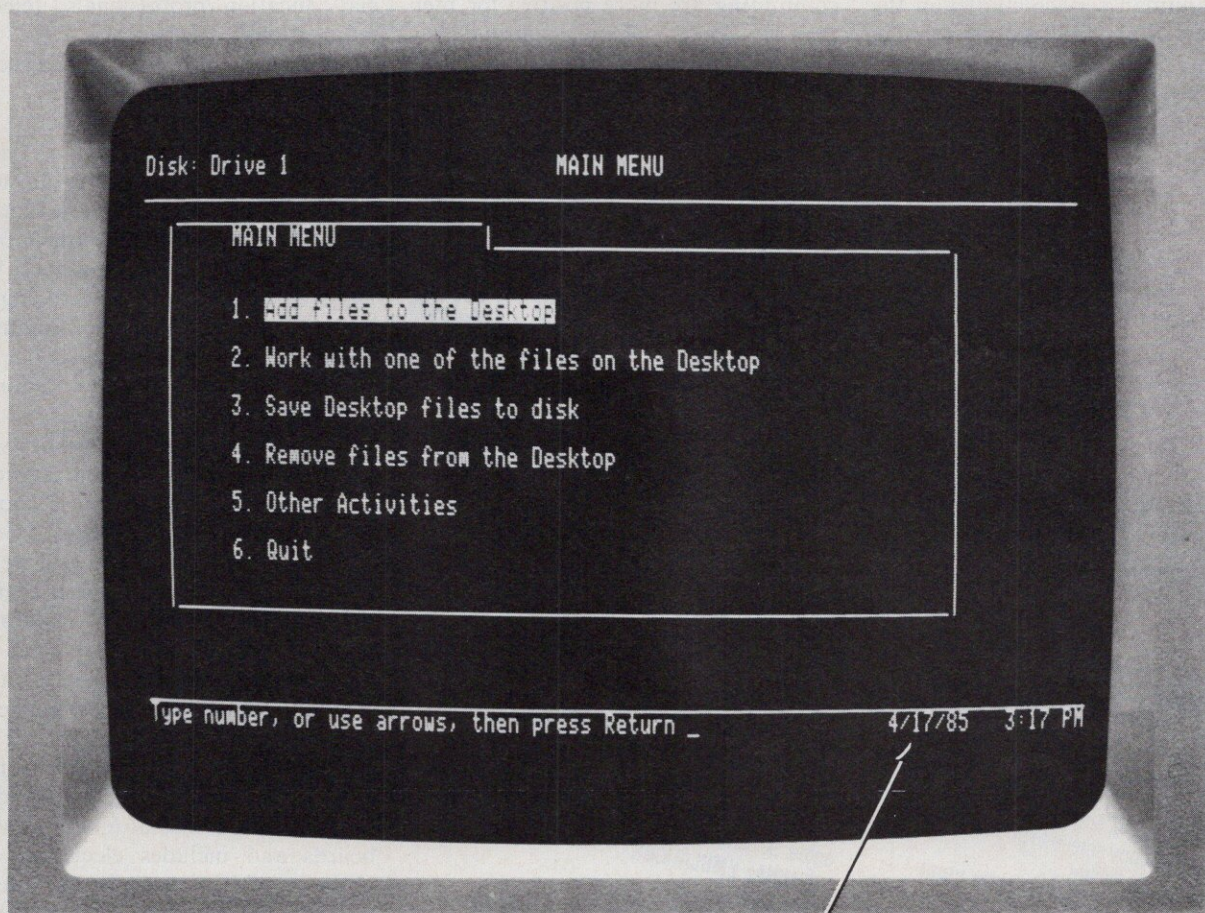

Just Look Right Here

Only the Timemaster H.O. displays the date and time on the Appleworks screen.* If you don't have a Timemaster H.O., you'll just get the help key reminder. The Timemaster H.O. will also automatically time and date stamp your files on disk. And don't forget, the Timemaster H.O. has all the features of all the competition combined, including year, leap year (not just in PRO-DOS), month, date, day, hours, minutes, seconds and milliseconds. The Timemaster H.O. is compatible with PRO-DOS, DOS 3.3, PASCAL and CP/M. And the Timemaster H.O. automatically emulates all other clock cards so you won't have any compatibility problems because the Timemaster H.O. works with ANY program that reads ANY clock.

In fact, you could put ALL the competitive cards in every slot in your Apple and you still wouldn't have all the features of the Timemaster H.O.

The Timemaster H.O. comes with a ton of fun and useful software. It has an easy to read yet detailed manual, a 20 year auto-recharging battery and a 3 year no hassle warranty.

TIMEMASTER H.O.

**SIMPLY PUT,
 IT'S SIMPLY THE BEST**

\$129.00 Complete

*If you purchased a Timemaster H.O. prior to AppleWorks support, an easy to use patch program is available for \$20.00.



APPLIED ENGINEERING
 We Set the Standard

Call (214) 241-6060 9 a.m. to 11 p.m., 7 days a week or
 Send check or money order
 P. O. Box 798
 Carrollton, Texas 75006



MasterCard, Visa and C.O.D. welcome. No extra charge for credit cards.

Texas residents add 5½% sales tax.
 Add \$10.00 if outside U.S.A.

be telecommuting by 1990.

The study notes that most people telecommute because it gives them flexibility with their schedule. Maternity leave and child care are other reasons. "Teleworkers" tend to put in more time, and corporations report increased productivity, less absenteeism, improved employee retention, and access to a larger labor pool.

Clinton McClintock, associate professor of human service studies in the New York State College of Human Ecology at Cornell University, has re-

leased a study on telecommuters. He notes telecommuters tend to be self-employed, highly educated adults who work most often in the morning and on weekday evenings. They tend to put in more working hours than they did before they telecommuted, and they report increased work productivity and quality and greater satisfaction with their jobs.

McClintock notes the effects of telecommuting are more positive for men than for women. Women reported they worked harder, had less leisure time,

and engaged in more conflict at home over time and space since they began telecommuting. McClintock notes that supervision for telecommuters must focus on work quality and scheduling requirements rather than on social cues such as punctuality and appearance.

The Oregon School Study Council has published a study on telecommunications and the handicapped. The study examines communication among special-education professionals, telecommunications technology for the handicapped, and programs used for special education in Oregon.

Electronic Libido

Playboy magazine, realizing that interest in the adult publishing business is falling, has branched into the lucrative VCR market with "live" videotapes of interviews and photo sessions. Well, *High Society* magazine is doing one better—entering the telecommunications field with its X-rated service Sextex from its subsidiary CVC Online.

Services include on-line conferences with centerfold models, sex experts, and other subscribers; X-rated adventure games; electronic mail; and a shop-at-home service. A spokesman for Sextex notes the service is "doing real well."

Sextex costs \$67.50 for a registration fee and \$11 per hour—plain brown wrapper optional.

Xnet has also introduced an adult-electronic-mail service that offers a "computerized version of the personal advertisements you've seen in many magazines and newspapers." It is divided into several special-interest bulletin boards and includes electronic mail. Xnet costs \$25 for a registration fee, \$5 monthly mailbox fee, and from \$7 to \$16.50 per hour, depending on the local time.

Humans has introduced CompuDate, a "national computerized single's club" offering "on-line computer matchmaking." Services include questionnaires, electronic mail, bulletin-board ads, on-line newsletter and forum, and personal profiles. A one-year membership costs \$39.95, and CompuDate is available on The Source.

Delphi, from General Videotex Corporation, offers Amsex, an interactive electronic newsletter that "serves as a forum for personal, public, and professional sex-related issues."

Bulletin-Board Services

If you cannot wait to use your modem, try calling some of these special-interest bulletin-board services (BBSs).

Roots-BBS caters to genealogists and others interested in searching for

SOFTERM 1&2

MICRO-TO-MAINFRAME

COMMUNICATIONS AND

EXACT TERMINAL EMULATIONS

SOFTERM 1 CONNECTS YOU WITH INFORMATION SERVICES.

Now you can access information services, bulletin boards, and electronic mail systems from home or office. Softerm 1 includes keyboard macros, a built-in phone book for automatic dialing, simultaneous capture to print or disk, copy screen to print or disk, and terminal status display.

SOFTERM 2 CONNECTS YOU WITH YOUR COMPANY'S COMPUTER.

This expanded version of Softerm lets you access the information stored in your company's mainframe. With either version of Softerm, you can download information into your Apple and capture it on your own disk in any format you choose—DOS, CPM™ or Pascal. Softerm's extensive file transfer capabilities provide automatic execution using command files, support for popular protocols like XMODEM, and our own Softrans™ protocol which comes with an adaptable program for your host computer.

MAKES YOUR APPLE WORK EXACTLY LIKE ANY MAJOR TERMINAL.

Softerm 2 includes exact emulations of more than 25 popular terminals, and provides all keyboard and display functions. Also, both conversational and block modes are supported.

Apple is a registered trademark of Apple Computer, Inc.

SOFTERM CAN'T BECOME OBSOLETE.

We constantly improve Softerm. And we make those improvements available to you 24 hours a day, 7 days a week. To update your program, simply dial our computer and transfer the improvements to your disk.

SOFTERM IS A COMMUNICATIONS BARGAIN.

Softerm 1 is only \$135; Softerm 2 is \$195. Plus, you get an unconditional 30-day money-back guarantee. So ask your dealer for a demonstration today.

TERMINAL EMULATIONS

TTY Compatible
ADDS Regent 20, 25, 40, 60
ADDS Viewpoint, Viewpoint78*
Data General D200, D410*
Datapoint 3601, 8220*
Digital Equipment VT52, VT102, VT220*
Hazeltine 1400, 1410, 1500, 1520
Hewlett Packard 2622A
Honeywell VIP 7205, 7801, 7803
IBM 3101 Model 10 and 20
Lear Siegler ADM-2*, ADM-3A, ADM-5
TeleVideo 910, 921*, 925, 950
Texas Instruments Model 931*

User Defined
*Coming Soon

Softerm is also available in versions for the IBM PC and Tandy Model 1000 and 2000 personal computers.

SOFTRONICS

3639 New Getwell, Suite 10, Memphis, TN 38118
For orders and information call 901-683-6850

CIRCLE 164 ON READER SERVICE CARD

Grappler® Graphics Relax! It's Easy

Whether you're looking for sunken treasure, or graphing your business sales, you must have effective graphics tools. And when it's time to print your results, you need to get what's on your screen off your screen. Enter the Grappler printer interface. Quick, easy and effective.

THE GRAPPLER IS YOUR HIDDEN TREASURE

We all know that a picture tells a thousand words, so your graphics are your most important printouts. With the Grappler, graphics printing is a snap. A few quick and easy keystrokes, and your Hi-Res image is promptly reproduced on just about any printer you care to name. Depending on which keys you hit, your graphics can be

printed enlarged, enhanced, inverted, rotated, and... well, the message here is flexibility.

A GRAPPLER DESIGNED FOR YOU

To date Orange Micro has sold over 255,000 Grapplers, so you know you're in experienced hands. There are Grapplers available for many popular micros, including parallel and serial models for the Apple IIe, a new version for the Apple IIc and an advanced Commodore 64 interface. Most Grapplers offer buffering or other valuable options. All come with the "Seldom Used 1 Year Warranty." There's a Grappler for virtually every application, so remember to ask for it by name when you purchase your printer interface. You'll be glad you did. Graphics printing has never been so easy.

Grappler®  **Orange Micro®**
inc.

1400 N. Lakeview Ave., Anaheim, CA 92807 • (714) 779-2772 • TELEX: 5101001014
CIRCLE 252 ON READER SERVICE CARD



Grappler® C
Now Available For
The Apple® IIc

If You Work With An Apple Computer...

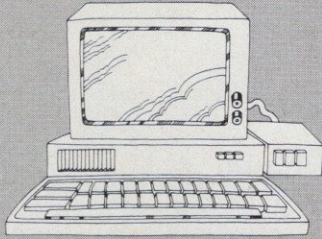

...You May Be Entitled To A Corporate Discount On

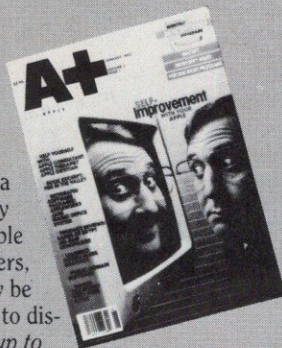

If you work in a company with Apple computers, you may be entitled to discounts up to

50% on A+, The Independent Guide for Apple Computing.

You need the professional advice and in-depth information from Apple experts you'll find every month in A+. You'll discover new business applications and products for your Apple—whether it's the Apple II, II+, IIe, IIc, III, Lisa or Macintosh.

For more information about the Corporate Subscription Program, complete and mail this coupon. For faster service, call Daniel Rosensweig collect at 212-503-5354.

THE MORE YOU ORDER THE MORE YOU SAVE!

ZIFF-DAVIS Computer Publications
Corporate Subscription Program
One Park Avenue, 4th Floor
New York, NY 10016
Attn: Daniel Rosensweig

- YES, I want more information on saving money through the ZIFF-DAVIS Corporate Subscription Plan.
 Please have Dan Rosensweig call me at ()

Name _____

Title _____

Company _____

Address _____

City _____

State _____ Zip _____

CA02

ancestors and applying computers to such research. Most messages deal with finding the origins of surnames, although hardware and software help and a list of BBSs is also available.

Although anyone can dial up the BBS, you need to get permission from sysop Brian Mavrogeorge to download files and enter conferences. Permission is granted to those actively participating on the BBS.

The Advocate BBS provides information on feeding, housing, health, and general pet care for parakeets, cats, guinea pigs, hamsters, and rabbits. A rather complete section of national and international general news about animals, from such proanimal organizations as the American Fund for Alternatives to Animal Research and the International Primate Protection League, is also available.

Noah's Ark specializes in plant and animal breeding. Information on birds,

fish, reptiles, and rare fruits and plants is available, as well as private electronic mail. The BBS also serves as a trading post for animals and plants.

Noah's Ark also has a section about magic (the sleight-of-hand kind). It includes a couple of rudimentary card tricks and a discussion about magic card decks.

Logging Off

Telecommunications offers a wealth of instant information for the business and for the home. The industry is growing, and more and more people are enjoying the benefits of telecommuting for research and leisure. Connecting a modem to your Apple places the world where it should be—at your fingertips. **+**

Russ Lockwood is an assistant editor of Creative Computing and a former staff writer for The New York Times Information Service.

► FURTHER INFORMATION

ITT Dialcom
1109 Spring Street
Silver Spring, MD 20910
(301) 588-1572

CIRCLE 367 ON READER SERVICE CARD

Link Resource
215 Park Avenue South
New York, NY 10003
(212) 473-5600

CIRCLE 368 ON READER SERVICE CARD

Electronic Services Unlimited
142 West 24th Street
New York, NY 10011
(212) 206-8272

CIRCLE 369 ON READER SERVICE CARD

Humans
P.O. Box 82
Evington, VA 24550
(804) 525-3441

CIRCLE 370 ON READER SERVICE CARD

Oregon School Study Council
1787 Agate Street
University of Oregon
Eugene, OR 97403
(503) 686-5045

CIRCLE 371 ON READER SERVICE CARD

CVC Online
801 Second Avenue
New York, NY 10017
(212) 986-5100

CIRCLE 372 ON READER SERVICE CARD

Xnet
P.O. Box 2365
Halesite, NY 11743
(516) 549-0811 (voice)
(516) 549-0845 (modem)

CIRCLE 373 ON READER SERVICE CARD

Professor Charles McClintock
New York College of Human Ecology
N135 Martha Van Rennselaer Hall
Cornell University
Ithaca, NY 14853

(607) 256-3290

CIRCLE 374 ON READER SERVICE CARD

The Source
1616 Anderson Road
McLean, VA 22102
(703) 734-7500

CIRCLE 375 ON READER SERVICE CARD

Delphi
3 Blackstone Street
Cambridge, MA 02139
(617) 491-3393
(800) 544-4005

CIRCLE 376 ON READER SERVICE CARD

Roots-BBS
(415) 584-0697 (modem)
8-bit word/no parity/one stop bit
300 and 1200 bps supported

CIRCLE 377 ON READER SERVICE CARD

The Advocate
P.O. Box 8896
Fort Collins, CO 80525
(303) 223-1297 (modem)
7-bit word/even parity
300 bps only

CIRCLE 378 ON READER SERVICE CARD

Noah's Ark
7074 Casitas Pass Road
Carpinteria, CA 93013
(805) 684-5996 (voice)
(805) 684-8020 (modem)
8-bit word/no parity/1 stop bit
1200 bps

CIRCLE 379 ON READER SERVICE CARD

IT'S HERE! THE ULTIMATE 'FANTEGY'™ COMPUTER GAME!

LORDLINGS OF YORE



\$39.95

(Dealer Inquiries
Invited)

*Fan-te-gy/'fan-te-jē/n:
A totally new game format
that combines the best
features of fantasy,
adventure and strategy
gaming in a world of
historical make-believe.

THE GAME OF
KNIGHTS, KNAVES & NECROMANCERS

Hi-res full-color graphics, sound, and animation are utilized in this unique new computer game to produce one of the most challenging player-vs-player or player-vs-computer concepts available anywhere. Realistic combat, hidden movement, limited knowledge of enemy

action and many other features make this game a "must" for those who seek a real test of their skill and ingenuity. Why wait? Order today and become a dedicated member of the LORDLINGS OF YORE "round table".

CIRCLE 238 ON READER SERVICE CARD

Available now for Apple series, IBM & C-64 versions coming soon. IBM, Apple & C-64 are registered trademarks of International Business Machines Corp., Apple Computers, Inc., and

Softlore Corporation

40 NE Loop 410, Suite 615, San Antonio, TX 78216

(512) 694-2800

Big Game Hunting? Try Baggin' Our Dragon.

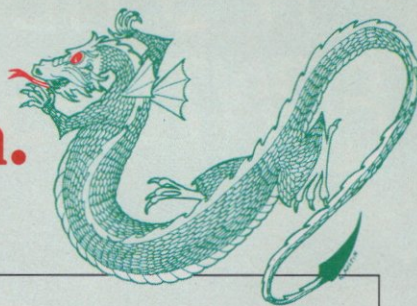

It's the biggest game in town

Our dragon, of course, is Wizardry—that unique series of computer recreation programs designed for Apple users who are seeking the ultimate “big game” challenge.

Since its debut, Wizardry has been the best-selling computer game of its kind.

For a very good reason:

Because Wizardry is more than just a game, more than a diabolically clever maze.

Wizardry is a complex world of variety and depth. A world of richness and pleasure.

Packed with suspense, full of surprises, Wizardry is enchanting—a compelling

diversion that turns your leisure time into prime time.

Wizardry is powerful and sophisticated. A simple command system, 3D maze displays and superb programming provide you with month after month of involvement and satisfaction.

Four years old and still growing, the game is already recognized by critics and game lovers as a classic.

Simply stated, Wizardry is the finest fantasy role-playing computer game you can buy.

Set your sights on the best. Track down Wizardry—the biggest game in town.

Enter the World of Wizardry®

A Classic Encounter

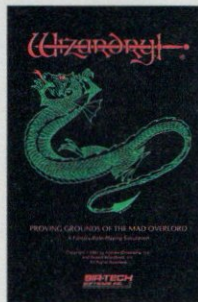

Proving Grounds of the Mad Overlord

The First Scenario

Unlike any other game you have ever played. A fascinating 10-level maze full of monsters, sorcery, traps and treasures. As you gain skills, the characters you create grow stronger, richer, wiser and better able to survive. The final goal is elusive. Your experience . . . unforgettable.

Twice voted “All Time Most Popular Computer Program”
—Softalk Readers

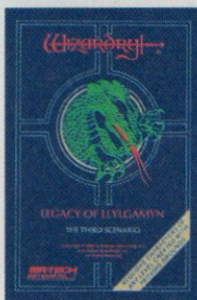

Legacy of Llylgamyn

The Third Scenario

A spellbinder that advances the classic traditions of Wizardry. Find the great dragon Lkbreth and save the people of Llylgamyn. Includes full screen maze display and Windo-Wizardry, the revolutionary pop-up window graphics system. Requires brave adventurers of any level developed in PROVING GROUNDS.

“ . . . A Landmark in Graphics Advancement” and “The Best Yet”
—Softalk

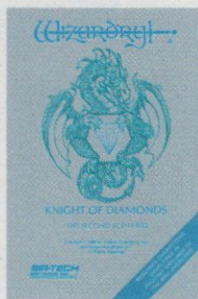

Knight of Diamonds

The Second Scenario

This classic journey should only be attempted with those Wizardry heroes who have attained the 13th level of ability in PROVING GROUNDS. Their challenge—and yours—to adventure through a six-level maze and become the Knight of Diamonds. First-rate fantasy!

Awarded “Best Adventure Game for the Home Computer”
—Game Mfrs. Association of America



Wiziprint

Character Statistics Printout

A helpful utility program that prints the possessions, attributes and known spells of all your Wizardry characters. Quick, neat and easy-to-read. For use with 80-column printers. Compatible with all Wizardry scenarios. A real timesaver!

“Wiziprint is a very handy utility disk for ardent Wizardry players”
—Roe R. Adams III, Softalk

LOOK FOR THE DRAGON—
SYMBOL OF WIZARDRY.
PROMISE OF EXCELLENCE.

All software available for Apple II series computer 48k
Coming soon for the Macintosh
Proving Grounds also available for IBM PC and PCjr 64k

SIR-TECH
SOFTWARE INC.

6 MAIN STREET • OGDENSBURG, N.Y. 13369 • (315) 393-6633 **LEADERS IN COMPUTER FANTASY ROLE-PLAYING**

SUSPECT
TYPING INTRIGUE
MACVEGAS
KAMPFGRUPPE
PLATO'S CAVE

THAT'S entertainment

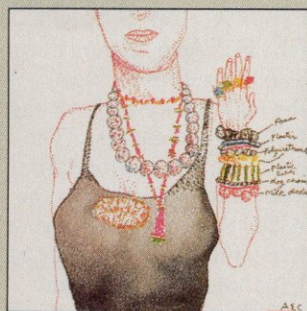

You've just been framed. You have only a few hours to figure out who the real murderer is before they come to take you away.

COWBOY SLEUTH

Somebody at Infocom must lie awake nights dreaming up packaging. I spent a good half hour just going through all the goodies that come with *Suspect* before I ever got around to booting up the game.

First, there's an engraved invitation to Veronica Ashcroft-Wellman's Halloween party—and in case you don't know who Veronica Ashcroft-Wellman is or how lavish her parties are, there's a clipping from the local magazine, describing just how posh this affair is going to be. The same clipping also has an article describing realtor William Cochrane's aggressive plans to break up local estates and turn them into "planned communities." His business card is included in the package—with an interesting note on the back for Veronica: "Don't do something you'll regret. (signed) Bill."

You'll also find a receipt from Costumes Unlimited—you've rented a cowboy suit—and a letter from the editor of *The Washington Representative* asking you to write up the party as a news story. Finally, there is a not very useful (but very funny) guidebook called *Murder and Modern Manners*.

This time around, you are a newspaper reporter

and a friend of Veronica's. Unfortunately, before you have much chance to chat with your hostess, she is found murdered—and the murder weapon is the lariat from your cowboy costume! Uh oh! Bad choice of costume. You've just been framed. You have only a few hours to figure out who the real murderer is before they come to take you away. This situation is roughly equivalent to the next-to-last reel of the first *Pink Panther* movie, in which Peter Sellers had to figure out who was the real villain in the gorilla suit, himself or David Niven.

Suspect has a lot of characters; it isn't an easy game. (It's advertised as "advanced," which is a little

like calling Indiana Jones "well-motivated"—something of an understatement.)

Before you can even begin to solve the murder, you have to find out who everyone is. Who's the man in the astronaut suit? Who's the werewolf? Why is Colonel Marston dressed like an African explorer? And who's *really* in the gorilla suit? Where is Inspector Clouseau now that we need him? And why did you choose to wear that stupid cowboy suit in the first place?

As with all Infocom games, be prepared to spend some time working your way through the convolutions of the plot. It's intricate, this one perhaps more than usual, and you

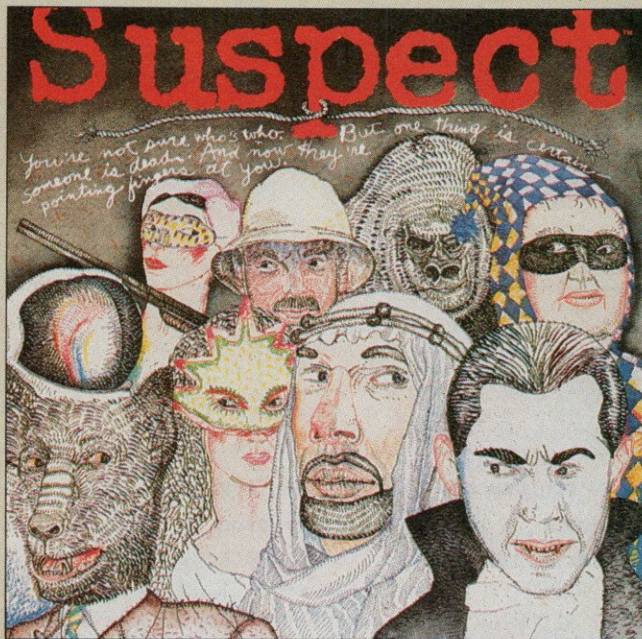

may eventually want to order a hint book from the company.

With this game, Infocom demonstrates (again) that the all-text adventure is an ideal format for a murder mystery. You are no longer a vicarious observer, as you would be in a novel or a film. Here you are a key part of the action. You have to explore the premises, examine objects to see if they are clues or not, follow suspects, interview the other guests at the party, and eventually confront the real murderer with the proof of his (her?) deed.

What makes the game truly exciting are the more than ample opportunities for failure. You can really get yourself in a lot of trouble here.

I'm not going to say

much more than that because I hate people who give away punch lines, surprises, and identities of murderers. If you want to find out how it ends, you're going to have to play this one for yourself.

Suspect is the third in the company's series of murder-mystery adventures. The first two were *Deadline* and *Witness*. Suspect may be the most devilish yet. Good luck, cowboy! You're going to need it . . .

David Gerrold

Suspect

Infocom
125 Cambridge Park Drive
Cambridge, MA 02140
(617) 492-1031

List Price: \$44.95

Requires: Apple II, II Plus, IIe, or IIc; 48K RAM; one disk drive—or Macintosh

CIRCLE READER SERVICE NO. 351

MISSING BATHTUB

Lord and Lady Southby lived a quiet life on their estate until somebody broke into their house and made off with a valuable antique gold-and-onyx bathtub.

Naturally, they called in the authorities. As Inspector Hargreaves, you must use all of your typing skills to solve the case of the missing bathtub.

Forethought bills Typing Intrigue as "the typing tutor with a mystery twist." Missing tubs aside, teaching you to touch-type is the real goal of this educational program for the Mac. It works best with beginners, although veteran touch-typists who need to brush up on their reflexes may find it helpful, too.

The program shows you proper body, hand, and finger positioning and explains the basics of touch-typing. Next, you take a typing test, called an audition, to determine a base typing speed. After these preliminaries, it's all up to your fingers.

Typing Intrigue teaches you typing through repetition. It starts with the home keys—A, S, D, F, J, K, L (the keys your fingers hover over)—and progresses through the keys above and below the home keys. The drills are straightforward. For example, you press the A key three times with your left-hand pinky, then the S key three times with your ring finger, and so on. This is the traditional method of teaching touch typing, and if you're willing to practice, it can improve your speed

PEOPLE TALK

DATA REPORTER

The DATA REPORTER puts your microcomputer at your command in the form of a powerful information management tool. Manipulate your data quickly and easily without programming or computer knowledge. The illustrated and indexed manual, with its numerous examples shows you how to achieve results with the DATA REPORTER. The simple step-by-step customizing feature lets you convert the DATA REPORTER into a general accounting (AP/AR/GL/PAYROLL), bibliography, sales journal, appointment calendar, or whatever application you need. If you want to alter your program, the DATA REPORTER lets you rearrange or add new information to all files without retyping your records.

Running the DATA REPORTER is simplified by prompting and sophisticated error avoidance techniques. Program options require only a few keystrokes to perform functions such as printouts, sorts, searches of records, totalling, etc. The helpful Soundex locator on the IBM version will find your records even if you do not know the proper spelling. When entering data, repetitive information and the current date may be entered with a single keystroke. Quick record entry is accomplished without long delays for disk access. Entering and updating information is done in MEMORY. THE FASTEST WAY POSSIBLE WITH A MICROCOMPUTER.

databases have to be

**POWERFUL!!
EASY!
QUICK!!!**

DATA REPORTER FEATURES INCLUDE: Simple menus for all commands; each record can have up to 10 calculated fields, subtotals and grand totals can be performed on any field; machine language searches and sorts are available on any combination of fields (Sort 300 on-line records in less than five seconds, search 300 records in less than one second); seven search types are available, including---soundex (IBM only), full field, substring, and their complements; sort data on up to three fields. Up to six files of data can stored in one operation; for repetitive tasks, batch sequences of up to 60 inputs can be saved and later performed with a single command (IBM only); file manipulation is simplified by global editing, file merging, file appending, and block deletion of data; features such as file backups, reformatting of files without reentering data, mailing labels, fully copyable disks, optional password protection, and many more make the DATA REPORTER the best data base value.



GRAPHS AND STATISTICS

The Data Reporter Graphics and Statistics program enables you to quickly and easily create graphs from existing data records. The graphs have four different types: bar graphs, scatter graphs, line graphs, and pie charts on your screen or printed. The Graphics and Statistics program will calculate totals, means (averages), standard deviations, medians, and ranges. It also calculates a least squares linear regression when you draw a scatter graph. Totals of all fields may be performed in only a few seconds. All statistics will be displayed on your screen and can be printed with your printer.

EACH PROGRAM for the IBM and APPLE computers include in their packages a powerful database, a report generator, a plotter/analyzer program, graphs and statistics programs, file conversion (Apple only), DOS remover (Apple only), modem package (Apple only), and/or user application programs. (Shipping \$3.00)
 DATA REPORTER I - database only \$ 89.00 // DATA REPORTER II - database and report generation \$ 149.00
 DATA REPORTER III - database, report generation, plotter/analyzer/graphs, and modem package \$ 199.00
 DATA REPORTER IV - personal research and statistics \$199.00 // VISA/MASTER CARD/CHECK// CALIF RES. PLUS 6%
 SOFTWEST PROGRAMMING 4418 E. CHAPMAN SUITE 156 ORANGE, CA 92667 TEL: 714-380-9437 TELEX: 6502502780 MCI
 CIRCLE 121 ON READER SERVICE CARD

and accuracy.

Typing Intrigue includes two games to give you a break from the lessons. The first, Rain, develops your finger-placement accuracy. Raindrops with letters inside fall from the top of the screen. You must type the letter (without looking at the keyboard—no cheating!) to make the raindrop vanish. If a raindrop reaches the bottom of the screen, the waters rise. Miss enough of the raindrops and you get flooded out. Rain has variable skill levels, from sprinkles to monsoon.

The typing workouts display combinations of phrases and sentences for typing practice. Again, you are supposed to look at the screen and not the keyboard. Although the exercises are not Pulitzer-prize-

winning efforts of literary excellence, they vary with each try and do test your touch-typing skills.

As you complete lessons, you gain "clue points." As you may have guessed, you trade these points in for clues. The more clues you obtain, the better your

chance of naming the crook and accomplice and discovering the motives behind the crime.

Typing Intrigue monitors your progress as you go along. It records words per minute, errors, and problem keys. The latter feature is especially helpful, for it al-

lows you to pinpoint exactly which keys give you the most trouble. You can then go back and practice those keys to improve your proficiency.

All in all, I'm impressed with Typing Intrigue. It combines practical teaching techniques, an interesting mystery twist, record keeping, and even two games into one easy-to-use program. Macintosh owners searching for typing tutors should investigate Typing Intrigue.

Russ Lockwood

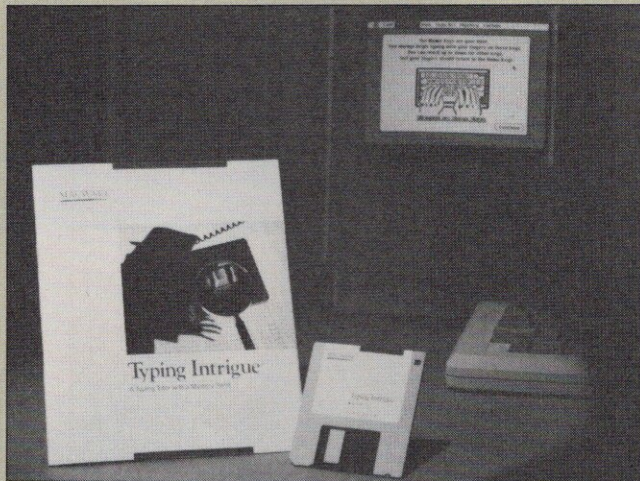

Typing Intrigue
Forethought
173 Landings Drive
Mountain View, CA 94043
(800) MAC-WARE
List Price: \$49.95
Requires: Macintosh
CIRCLE READER SERVICE NO. 352

Precision Data Products
Complete Line of Quality Supplies for Your Computer

TOLL FREE ORDER LINE
800-258-0028
FOR INFORMATION CALL
616-452-3457

MasterCard C.O.D. VISA

COMPLETE LINE OF 3M DATA RECORDING PRODUCTS

3M DATA CARTRIDGES
DC 1000 (For 3 1/2" Drive Backup) \$14.25 Each
Sold 10/Box

3M DISKETTES

5 1/4"	SSDDRH	\$1.39 Each
	DSDDRH	\$1.69 Each
	SSDD 96TPI RH	\$2.05 Each
	DSDD 96TPI RH	\$2.49 Each
3 1/2"	SS Micro Diskette	\$2.79 Each
	DS Micro Diskette	\$3.99 Each

Sold 10/Box

ORDER NOW—LIMITED TIME OFFER

"APPLES TO APPLES"
We will **BEAT** any price on 3M Diskettes in this issue. [Guaranteed same day shipping of in-stock items on orders placed by 2:00 p.m. E.S.T. NEED IT FAST? Ask about 1-DAY AND 2-DAY DELIVERY SERVICE (available for a reasonable upcharge)].

MINIMUM ORDER \$25.00
Add 10% for quantities less than 50
Shipping and Handling \$4.00 per 100 diskettes.
\$3.00 per 5 data cartridges.
Reduced shipping charge for larger quantities.
C.O.D. add \$3.00. MI residents add 4% sales tax.

Precision Data Products
P.O. Box 8367, Grand Rapids, MI 49508
(616) 452-3457 • Michigan 1-800-632-2468
Outside Michigan 1-800-258-0028

CIRCLE 228 ON READER SERVICE CARD

Set Up Your **DOT MATRIX PRINTER**
With a Touch of a KEY!

PCP™ **PRINTER CONTROL PROGRAM**

No longer do you have to enter long "set up strings" to take advantage of your DOT MATRIX PRINTER's capabilities. Just select from the MENU...let your computer do the rest! Condensed Characters, Double Strike Printing, Emphasized Characters, Special Line Spacing, and more! Comes complete with PROGRAM DISKETTE and OPERATING MANUAL. Includes information on how to program your printer in Basic, VisiCalc®, Applewriter. PCP is a very handy utility program you will use again and again!

VERSIONS:
Apple II, II+, IIe and III WITH
Apple DMP & Imagewriter
Epson MX*, RX & FX Printers
C.Itoh Prowriter I & II
NEC PC8023A
Okidata 82A, 83A, 92, 93 & 84
Gemini Star 10, 10X & 15

EPSON PRINTER CONTROL PROGRAM

PRINTER OPTIONS

A CONDENSED	G 4 LINES/INCH
B DOUBLE WIDTH	H 8 LINES/INCH
C ITALICS	I 10 LINES/INCH
D HALF SIZE	J SPECIAL SPACING
E EMPHASIZED	K UNIDIRECTIONAL
F DOUBLE STRIKE	L BIDIRECTIONAL

SOME COMBINATIONS

M EMPHASIZED DOUBLESTRIKE
N DOUBLEWIDE EMPHASIZED
O DOUBLEWIDE EMPHASIZED DOUBLESTRIKE
P CONDENSED DOUBLEWIDE
Q CONDENSED DOUBLEWIDE DOUBLESTRIKE
R CONDENSED DOUBLESTRIKE
S CONDENSED HALF SIZE
T RETURN TO STANDARD SETTINGS

TYPE LETTER, PRESS RETURN (0 ENDS)

THIS IS WHAT THE EPSON MX VERSION MENU LOOKS LIKE

Be sure to specify BOTH microcomputer and printer to obtain correct version.

PRO/PAC
14925-A Memorial Drive, Dept. B
Houston, Texas 77079
(713) 496-1179

ONLY \$29.95
plus \$2.00 shipping and handling USA
VISA and MasterCard Credit Cards
See Your Dealer or Write or Call Us!

* Requires Graffrax Plus™ For Full Features
APPLE® is a registered trademark of Apple Computer, Inc.

CIRCLE 165 ON READER SERVICE CARD

THE RIGHT CONNECTIONS

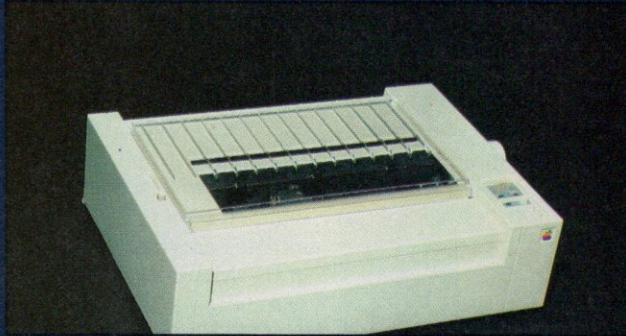

Printer serial port



Modem serial port



Clock/Calendar



Software Utilities

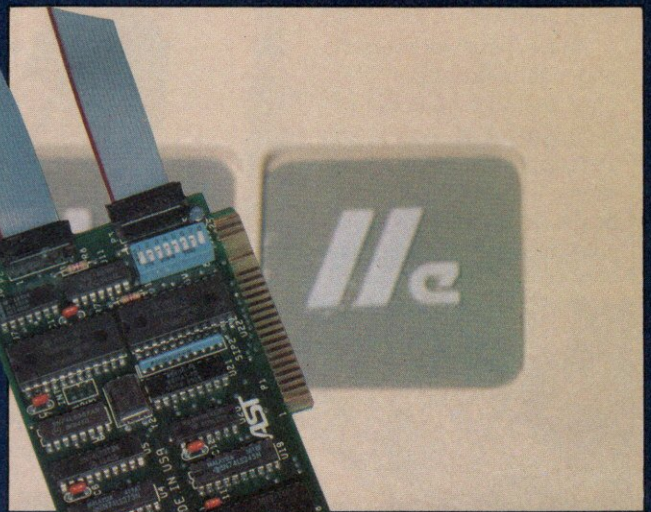

Apple IIe compatible

AST's Multi I/O™ is a multifunction card for the Apple IIe™ that does the work of three individual boards. First, the Multi I/O printer serial port gives you the right connection to hook up your ImageWriter™ or a compatible serial printer. Second, Multi I/O provides you with the right connection to communicate with the outside world via the modem/terminal port. And the versatile clock/calendar is the right connection for AppleWorks™ and ProDOS™ providing you with the accurate date and time even when your computer is turned off.

At AST we are consistently providing the right connections to help you get the most out of your personal computer. We set the standard for enhancement products for personal computers by bringing you the type of quality products you expect, but at a very cost effective price.

Apple, Apple IIe, ProDOS, Appleworks, ImageWriter, Lisa, and Macintosh XL are trademarks of Apple Computer, Inc.

Multi I/O, RamStak, and MicroStar are trademarks of AST Research, Inc.

MicroStar™ is the 10 MB hard disk and tape backup (opt.) system that provides the right connection between the Apple IIe and dependable 3.5" Winchester Disk/Cartridge tape mass storage.



RamStak™ is the right connection for expanding the memory capability of your Macintosh XL™ (Lisa™). The card provides additional memory in configurations ranging from 512K to 2.0 MB.

We help Apples™ grow!™

AST
RESEARCH INC.

2121 Alton Avenue, Irvine, CA 92714
(714) 863-1333 Telex 753699 ASTR UR

GAMBLERS' DELIGHT

Las Vegas, Nevada: a glittery haven in the desert for tourists and gambling maven's intent on breaking the bank at the casinos. For most, the dream of instant riches lies shattered at the bottom of a penniless pocket, but for those select few who can combine skill and luck, the downtown strip is a street paved with gold.

MacVegas transforms your Macintosh into a one-mouse casino, complete with seven gambling games: Baccarat, Blackjack, Craps, Keno, Poker, Roulette, and Slots. Each of these has four variations of "house rules" (betting minimums and maximums and odds of winning). Poker and Roulette are for solo

play only; the rest of the games accommodate one or two players. With the exception of entering your name, you control all play with the mouse.

Play proceeds smoothly. If you understand the rules of the particular game, you can start immediately. You pick up and drag chips to a betting area (subject to

minimums and maximums) and then play the game by clicking on a particular choice from several options displayed on the screen. Additional decisions, such as whether to take another card or not, require extra points and clicks.

MacVegas comes with a 158-page paperback, *A Book on Casino Gambling*

by Virginia Graham and C. Ionescu Tulcea (Pocket Books). The book explains each game in detail and offers tips on beating the casino.

The program takes advantage of the Macintosh graphics to produce clear, sharp representations of cards, chips, betting areas, dice, and other gambling paraphernalia. The animation is smooth, especially the shuffling cards and rolling dice.

Your enjoyment of MacVegas will depend on your interest in gambling games. If you've ever felt the need to escort Lady Luck to a table in Las Vegas, Reno, or Atlantic City, yet were unwilling to risk real dollars, MacVegas is the answer. If you really are planning a casino trip, on the other hand,

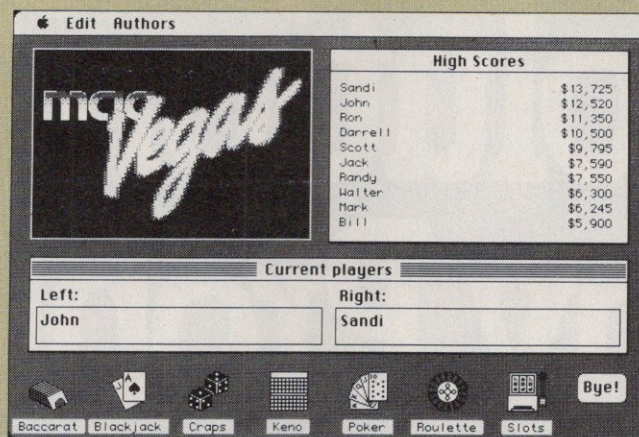

We Make Measurement And Control Easy!

12 BIT, 16 CHANNEL, PROGRAMMABLE GAIN A/D

- All new 1984 design incorporates the latest in state-of-art I.C. technologies.
- Complete 12 bit A/D converter, with an accuracy of 0.02%!
- 16 single ended channels (single ended means that your signals are measured against the Apple's GND.) or 8 differential channels. Most all the signals you will measure are single ended.
- 9 software programmable full scale ranges, any of the 16 channels can have any range at any time. Under program control, you can select any of the following ranges: ± 10 volts, $\pm 5V$, $\pm 2.5V$, $\pm 1.0V$, $\pm 500MV$, $\pm 250MV$, $\pm 100MV$, $\pm 50MV$, or $\pm 25MV$.
- Very fast conversion (25 micro seconds).
- Analog input resistance greater than 1,000,000 ohms.
- Laser-trimmed scaling resistors.
- Low power consumption through the use of CMOS devices.
- The user connector has +12 and -12 volts on it so you can power your sensors.
- Only elementary programming is required to use the A/D.
- The entire system is on one standard size plug in card that fits neatly inside the Apple.
- System includes sample programs on disk.

PRICE \$319

A few applications may include the monitoring of ● flow ● temperature ● humidity ● wind speed ● wind direction ● light intensity ● pressure ● RPM ● soil moisture and many more.

A/D & D/A

- A/D & D/A Features:**
- Single PC card
 - 8 channels A/D
 - 8 channels D/A
 - Superfast conversion time
 - Very easy programming
 - Many analog ranges
 - Manual contains sample applications

A/D SPECIFICATIONS

- 0.3% accuracy
- On-board memory
- Fast conversion (078 MS per channel)
- A/D process totally transparent to Apple (looks like memory)
- User programmable input ranges are 0 to 10 volts, 0 to 5, -5 to +5, -2.5 to +2.5, -5 to 0, -10 to 0.

The A/D process takes place on a continuous, channel sequencing basis. Data is automatically transferred to its proper location in the on-board RAM. No A/D converter could be easier to use.

D/A SPECIFICATIONS

- 0.3% accuracy
- On-board memory
- On-board output buffer amps can drive 5 MA
- D/A process is totally transparent to the Apple (just poke the data)
- Fast conversion (003 MS per channel)
- User programmable output ranges are 0 to 5 volts and 0 to 10 volts

The D/A section contains 8 digital to analog converters, with output buffer amplifiers and all interface logic on a single card. On-card latches are provided for each of the eight D/A converters. No D/A converter could be easier to use. The on-board amplifiers are laser-trimmed during manufacture, thereby eliminating any requirement for off-set nulling.

PRICE \$199

SIGNAL CONDITIONER

Our 8 channel signal conditioner is designed for use with both our A/D converters. This board incorporates 8 F.E.T. op-amps, which allow almost any gain or offset. For example, an input signal that varies from 2.00 to 2.15 volts or a signal that varies from 0 to 50 mV can easily be converted to 0-10V output for the A/D.

The signal conditioner's outputs are on a high quality 16 pin gold I.C. socket that matches the one on the A/D's so a simple ribbon cable connects the two. The signal conditioner can be powered by your Apple or from an external supply.

FEATURES

- 4.5" square for standard card cage and 4 mounting holes for standard mounting. The signal conditioner does not plug into the Apple, it can be located up to 1/2 mile away from the A/D.
- 22 pin .156 spacing edge card input connector (extra connectors are easily available i.e. Radio Shack).
- Large bread board area.
- Full detailed schematic included.

PRICE \$79

I/O 32

- Provides 4, 8-Bit programmable I/O Ports
- Any of the 4 ports can be programmed as an input or an output port
- All I/O lines are TTL (0-5 volt) compatible
- Your inputs can be anything from high speed logic to simple switches
- Programming is made very easy by powerful on-board firmware
- The I/O 32 is your best choice for any control application

The I/O manual includes many programs for inputs and outputs.

Some applications include:

Burglar alarm, direction sensing, use with relays to turn on lights, sound buzzers, start motors, control tape recorders and printers, use with digital joystick.

PRICE \$89

Please see our other full page ad in this magazine for information on Applied Engineering's Timemaster Clock Card and other products for the Apple. Our boards are far superior to most of the consumer electronics made today. All I.C.'s are in high quality sockets with mil-spec. components used throughout. P.C. boards are glass-epoxy with gold contacts. Made in America to be the best in the world. All products compatible with Apple II and //e.

Applied Engineering's products are fully tested with complete documentation and available for immediate delivery. All products are guaranteed with a no hassle three year warranty.

Texas Residents Add 5% Sales Tax
Add \$10.00 If Outside U.S.A.

Send Check or Money Order to:

APPLIED ENGINEERING
P.O. Box 798
Carrollton, TX 75006

Call (214)241-6060
9 a.m. to 11 p.m. 7 days a week
MasterCard, Visa & C.O.D. Welcome
No extra charge for credit cards

**Introducing
The Single
Solution To
Many Problems
That Can
Tie Up Your
Personal
Computer.**

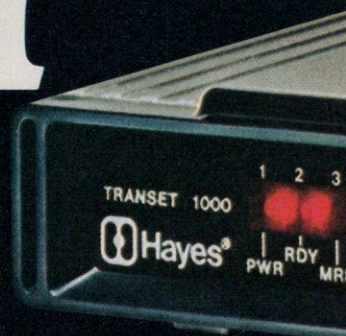

Transet 1000™ The print buffer, communications buffer, port expander, printer sharer and I/O switcher. All in one.

Anyone with a personal computer and one or more peripherals has faced the all-too-familiar dilemma. You need your computer to do an important job. But you're forced to wait for the system to finish one job (printing, communicating, whatever) before you can go on to the next one. Or you need to stop what you're doing to switch cables when you want to use another peripheral.

Wait no more. Now Hayes introduces an innovative new device that lets you perform many jobs—at the same time—independent of your computer. Transet 1000. It works with a wide range of systems and configurations. And it allows you to continually expand your system as your needs grow.

Transet 1000 frees your computer from waiting on your printer or modem—so you and your computer can go on to another task. It even lets you print out documents in pre-set formats without having to go back into your computer. At the same time, Transet 1000 can operate unattended mailbox communications—24 hours a day—even if your computer is turned off.

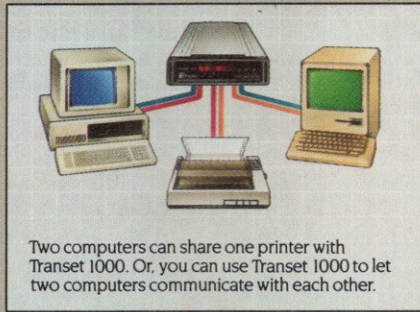

In addition, Transet 1000 is a port expander and software-controlled I/O switcher. Now files can be easily directed and redirected to different peripherals, without physically changing cable connections.

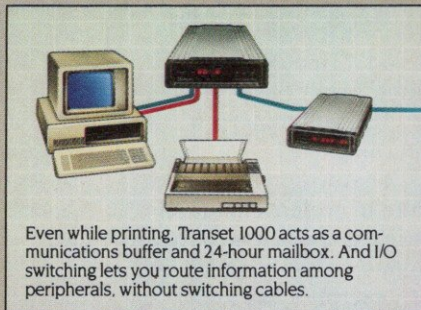

Transet 1000 contains a stand-alone microprocessor, and comes with 128K of memory. It operates with any RS-232C interface computer, and has optional accessory kits available for the IBM PC and PC XT, Macintosh and

Apple IIc. Kits contain the necessary host cable, a user guide and menu-driven software that lets you graphically set up or customize port

parameters and printing formats. Cables available for IBM PC AT, other computers and peripherals.

Like all Hayes products, Transet 1000 combines sophisticated capabilities with easy operation. Just as Hayes set the standard in personal computer communications, now Hayes is taking the lead in computer task management.

Contact your authorized Hayes dealer to see how Transet 1000 can help you get a lot more productivity

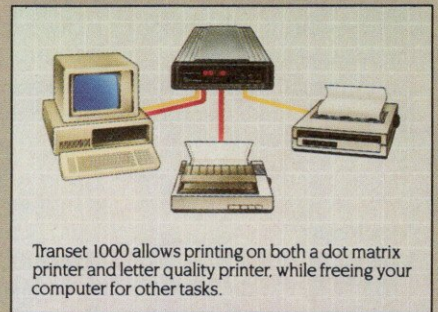

out of your computer system—without tying up your computer or you.

Hayes Microcomputer Products, Inc., P.O. Box 105203
Atlanta, Georgia 30348
404/441-1617



Hayes Transet 1000

Innovative products for enterprising people

you may want to sharpen your gambling skills before you go.

Of course, you do lose the casino atmosphere when playing at home or in the office—after all, MacVegas does not include skimpily-clad beauties serving cocktails or bowlegged tourists in loud Hawaiian shirts sweet-talking the slot machines—but if you are looking for an excellent gambling simulation for the Macintosh, take a serious look at MacVegas.

Russ Lockwood

MacVegas

Videx
1105 N.E. Circle Blvd.
Corvallis, OR 97330
(503) 758-0521

List Price: \$59

Requires: Macintosh

CIRCLE READER SERVICE NO. 353

SECOND CHANCE ON THE RUSSIAN FRONT

About ten years ago, I was visiting a friend's house and discovered that he had a large—and I mean large—map of the Pacific Ocean spread out across his den floor. The map showed half of the planet, almost everything between China and California, Australia and Alaska. Covering the map were thousands of tiny markers representing battleships, aircraft carriers, fighters, bombers, troop carriers, PT boats—one of them was probably even Amelia Earhart.

When I asked him, "Don, what are you doing here?" he replied, "I'm Japan, and I'm invading the United States. Only this

time I'm going to do it right. I'm not stopping at Pearl Harbor—I'm going on to attack the shipyards at San Diego as well. There's a guy in Boston who's going to be very very surprised."

"Not to mention the guys in Washington, D.C."

Kampfgruppe is a simulation of tactical-level combat on the Russian front.

I said. "Does Roosevelt know about this?"

"He will tomorrow morning . . ."

That was my first exposure to professional-level war gaming, a kind of battle simulation so complex that it sometimes has to be

played in slower-than-real time. "What it really needs," Don explained to me, "is a computer to keep track of all the moves."

Right. It was inevitable.

Kampfgruppe is a simulation of tactical-level combat on the Russian front during the years 1941–1945. (And we all know how that turned out. The decision to invade Russia was one of Hitler's worst military errors.) But the people at Strategic Simulations obviously think that the German army could have won that campaign, and this game is an opportunity for would-be generals to test their own battle prowess in the same circumstances. Actually, the game gives you the opportunity to set up a variety of military situations.

BUSINESS • SCIENCE • EDUCATION

The complete
Apple II
statistical
package
for only:

\$99

APP-STAT

A Powerful Tool for Data Analysis and Forecasting

- Easy to use, no commands to memorize (menu-driven)
- Can handle very large data files
- Descriptive Statistics, t-tests (independent and dependent samples) General ANOVA/ANCOVA (up to four factors, Repeated Measures, unbalanced designs, contrasts adjusted means, and more), Correlations, Multiple Regression (up to 25 predictors), Cross-Tabulation, Significance Tests, Nonparametric Statistics, and more
- User defined (multiple) conditional selection of subsets of cases, various ways of treating missing data
- Flexible Data Editor, easy entering/editing of data, complex (conditional) transformations of variables, and more
- Can also access files created by spreadsheets and data bases
- Barcharts, Scatterplots, clear comprehensive output
- Will run on APPLE II, II PLUS, IIc and IIe with 80 column display, 1 disk drive

To order send check or money order for \$99 (includes shipping and handling) to:

STATSOFT

2831 East 10th Street, Suite 3, Tulsa, OK 74104. (918) 583-4149

ASK ABOUT THE VERSION FOR MACINTOSH!

Apple, and Macintosh are a registered trademark of Apple Computer, Inc.

CIRCLE 207 ON READER SERVICE CARD

WELCOME TO YOUR CLUB!

NOW AVAILABLE FOR APPLE AND COMMODORE

Want to acquire useful software without spending a fortune? Then this is the club for you! Your monthly disk will be full of programs your family will enjoy. Games, educationals, music, tutorials, home management, others—all for the low member's price of only \$9.95. No dues, no shipping-handling charges, no obligations. Member benefits include a free monthly newsletter, helpful tips, discounts, bonus coupons, awards. Multiply your enjoyment of your home computer! Mail the form below today!

\$9.95 per month

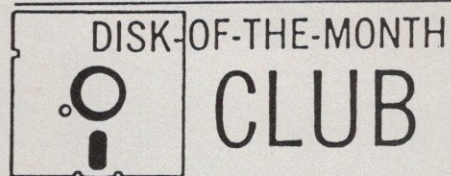

3002 Hwy 90 E., O.S., MS 39564

YES, I'd like to know more about my club. Please send me this month's disk. Enclosed is \$9.95 (Mississippi residents add 60% state sales tax).

Name _____

Address _____

City _____ State _____ Zip _____

Type of computer _____

CIRCLE 219 ON READER SERVICE CARD

Make no mistake here. This program is not so much a game as it is a very real simulation of battle conditions. There are no flashy arcade graphics here, no explosions, no sound effects, no clever animation. What there is in *Kampfgruppe* is the bookkeeping that is necessary to stage a large-scale battle, translated into a computer environment for advanced-level war gamers.

As commanding general, you will have to determine the moves of every man and piece of equipment under your command. Just entering the appropriate orders can be a long and involved process. You can play the game either as solitaire against the computer or as a two-player game, with the computer keeping track of all the details. You can play either side of the battle, or you can let the computer play both sides.

If you're not a war gamer, then *Kampfgruppe* is definitely not for you. If you are a war gamer, then you probably know how hard it is to find experienced partners to play

against. You probably also know how annoying all that bookkeeping can be sometimes. *Kampfgruppe* can be a worthwhile solution to both of these problems.

If, like me, you're curious about war gaming but haven't had a lot of opportunity to get deeply into it, then *Kampfgruppe* may be a good introduction, but be prepared to spend a couple of days studying the manual and another few days learning your way around the program. *Kampfgruppe* is not a game as much as it is a career. Be warned. It isn't dull, but it is involved—if you're not totally committed to the task, then it can quickly become tedious.

But then again, nobody ever said that fighting a war was a good time.

David Gerrold

Kampfgruppe
Strategic Simulations
883 Stierlin Road
Bldg. A-200
Mountain View, CA 94043
(415) 964-1353
List Price: \$59.95
Requires: Apple II Plus, IIe,
or IIc; 48K RAM; one drive
CIRCLE READER SERVICE NO. 354

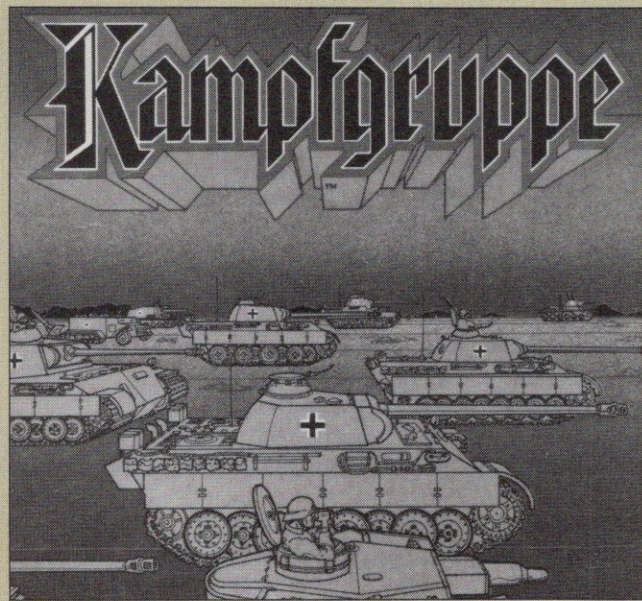

PHILOSOPHER'S DILEMMA

Approximately 2500 years ago, the Greek philosopher Plato posed a metaphor concerning shadows cast upon the walls of a cave. In essence, he argued that the realities we believe to be true are actually illusions and distorted images of a higher reality.

Plato's Cave from Krell Software takes this philosophical question and turns it into an exercise in scientific inquiry. You send beams of light into a cave and watch what happens after they strike hidden objects within it. Based on the data you receive, you then try to determine the nature and location of the objects.

The cave is a grid of dots surrounded by lettered and numbered entry and exit points. The grid ranges from a small 3 x 3-dot matrix to a large 13 x 13-dot matrix. The program has five types of objects—right reflector, left reflector, absorber, mirror, and a random object. The right and left reflectors deflect the light beam 90 degrees, the absorber stops the light beam, and the mirror reflects the light beam 180 degrees. The random object can take on the property of any of the other four objects, and it can also change properties during play.

You place up to seven objects in the cave—you choose the number, and the program chooses which types.

You pick an entry point, a beam of light enters the cave, and the program reports what happened to the light beam inside the cave and where it exited. Armed with this information, you figure out which

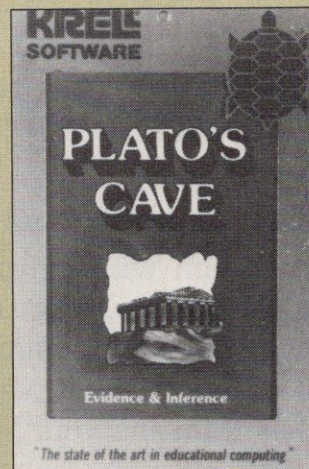

objects are where.

The program uses six difficulty levels, with each level allowing an additional type of object. Other features include reviewing

Plato's Cave is an interesting brainteaser for all ages.

data, reviewing play, and providing hints.

Plato's Cave is an interesting brainteaser for players of all ages. Young children can start with small matrices, few objects, and a low difficulty level, and adults can increase the size and complexity of the cave. I cannot say the program will solve the reality vs. illusion dilemma, but Plato's Cave does provide solid mental exercise.

Russ Lockwood

Plato's Cave
Krell Software Corp.
1320 Stony Brook Road
Stony Brook, NY 11790
(516) 751-5139
List Price: \$49.95
Requires: Apple II Plus, IIe,
or IIc; 48K RAM; one disk drive
CIRCLE READER SERVICE NO. 366

*First of the second generation hard disk drives for Macintosh.

You *need* a Macbottom™ hard disk drive to enhance the power and speed of your Macintosh. Macbottom with ten plus megabytes of storage is the fastest disk you can attach to your Macintosh. And more data storage no longer means sacrificing desk space. Macbottom is the only high capacity hard disk drive system that's two inches high and fits perfectly under your Macintosh. Since it weighs less than five pounds you can take it everywhere you take Mac. Macbottom and your Macintosh are a perfect match.

Macbottom . . . designed by Mac Users . . . for Mac Users!

- Built-in power fail detection protects valuable disk data.
- Automatic turnon feature requires no extra switches.
- Connects to either modem or printer port.
- Variable size volume allocation utilizes all available space efficiently.
- Backup program makes backup foolproof and fast!
- Printer spooler frees the Macintosh™ for more work.
- Works with 128k or 512k Macintosh.
- Warranted for six months—parts and labor.



Personal
Computer
Peripherals
Corporation

6204 Benjamin Road Tampa, FL 33614
1-800-MACBUTT (813) 884-3092

CIRCLE 224 ON READER SERVICE CARD



Come see Macbottom during the Boston
MACWORLD Expo at booths 326 and 328.

Macintosh is a trademark licensed to Apple Computer, Inc.

▶ A+ / AUGUST 1985

Macintosh

FEATURING THE APPLE 32 LINE

VideoWorks

An Animation Sensation

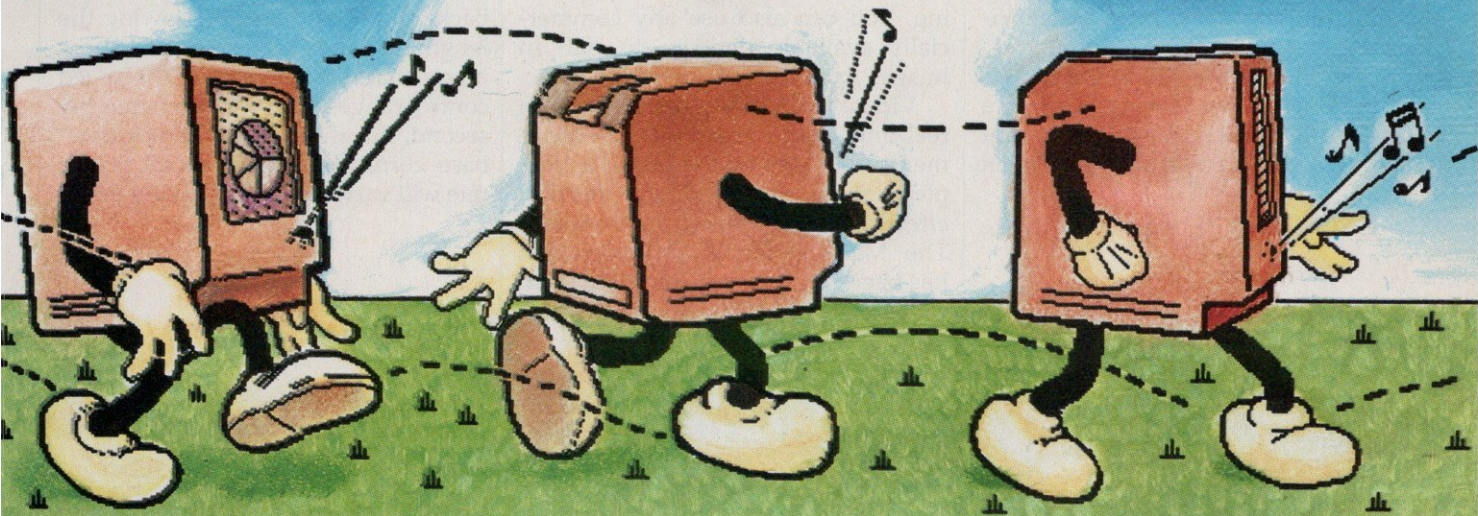

Public-Domain Software—Part II

ThunderScan Digitizer

MacPaint Tips

*VideoWorks doesn't
make you wait for
instant animation
gratification.*

VideoWorks

VideoWorks is one of the applications that best exemplifies the unique capabilities of the Macintosh. It is a comprehensive three-disk package from Hayden Software that includes VideoWorks, an animation application program with three tutorials and a special-effects demo; an Art disk, which provides predrawn modular figures for animation; and Movies, an anthology of fully developed sample animation sequences.

VideoWorks effectively employs the Mac user interface of menus and windows, controlled by mouse and/or keyboard commands. Animating has never been easier. VideoWorks operates most effectively on the Macintosh 512K, but it has been honed down to work even on a single-drive 128K machine, a feat akin to a circus act in which a dozen

*In less than five
minutes, you can be
following that
bouncing ball.*

clowns explode out of a tiny car.

VideoWorks can animate figures you've created within its own two graphics programs and can also import MacPaint documents from any source with ArtGrabber, its Clipboard-type desk accessory. ArtGrabber permits you to view quickly all the MacPaint documents in a disk, either in full-scale detail or in a miniaturized ShowPage window. ArtGrabber lets you bring these images into the VideoWorks program for animating. You can also use any commercially available digitizer to pull in images from the outside world.

VideoWorks can animate either in real time or in frame-by-frame increments. The icing on the cake is a complete menu of sound and musical effects to complement the visuals. The Mac's potential for animation has been correctly realized here as an esthetic of black-and-white linear

precision, as opposed to Apple II graphics programs in which the details are coarser but enhanced by color (see "Making It Move," *A+*, May 1985, pages 76-82).

Inside the Mouse Factory

The well-written documentation includes background on the history of animation, and its step-by-step continuity helps clarify what is really a complex program. VideoWorks' creator, MacroMind, is the same group that gave us the popular MusicWorks, and the two programs share similar structures for graphic control of form and duration.

The VideoWorks screen opens up with a control panel at the top right, including toggles for starting and stopping, speed control, sound switch, light switch for white or black background, and a grid showing the length of the sequence and how many channels are active. The speed control ranges from 3 to 60 frames per second, but the program is not time-base corrected, so the actual screen rate will vary, depending on the mem-

MICK WIGGINS

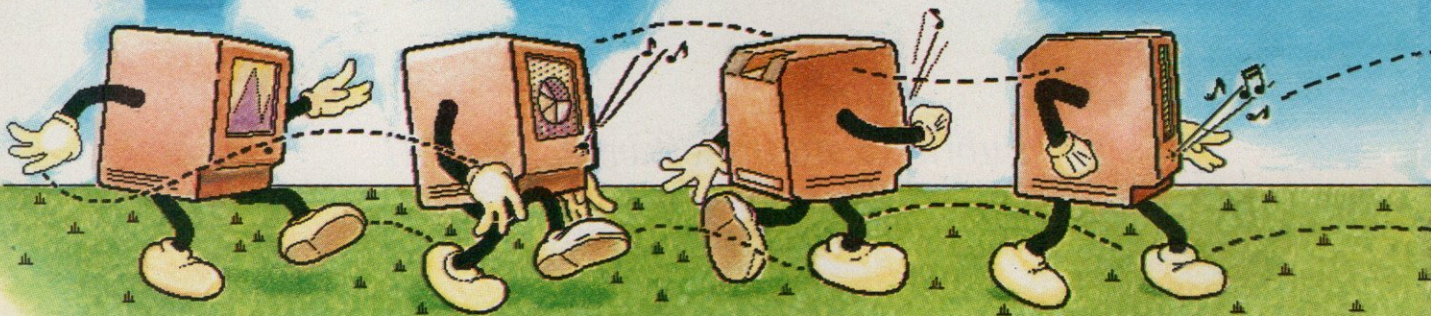

ory load of the active sequence.

At the bottom of the screen is the Cast, an eight-cell storyboard strip. As you create each animation element (called a Castmember in the manual), its image is automatically filed in a Cast cell. At the right end of the Cast is the row selector, with boxes that can call up eight more strips, for a total of 64 cells of Castmembers. Owners of 512K Macs see an additional bank selector that lets them access the 256 cells they have available. At the far end of the Cast is the QuickDraw Primitives cluster, a compact graphics kit. These are just two of the seven working windows available from the upper menu bar or through keyboard commands.

CheapPaint is a MacPaint-type graphics program with most of the latter program's features, including text and a full Fatbits

option. To be fair, CheapPaint is a misnomer—perhaps it should have been called MiddleIncomePaint or UpwardlyMobilePaint. The QuickDraw primitives are cheaper, especially in terms of memory usage. You can draw basic shapes directly on the screen, filling them with patterns available from the Draw menu, to create animation elements. QuickDraw is especially effective for laying in backgrounds. From these two internal graphics sources alone, you can create enough shapes and forms to explore VideoWorks' vast sound stage of a program.

VideoWorks doesn't make you wait for instant animation gratification. In less than five minutes, you can be following that bouncing ball. From CheapPaint's palette you can create a circle on the active easel and see it automatically appear in miniature within the first cell of the Cast strip (see figure 1).

You have just created a "sprite." A sprite is an autonomous animation element, whether it is a dot, a duck, or a defender. With true Mac ease, you can make the CheapPaint window disappear by clicking on its Close box and then drag a copy of the sprite from its cell in the Cast and place it anywhere on the screen. When you release the mouse button, a grid of nine small squares appears over the sprite, indicating that it is an active element (see figure 2).

To create a real-time animation sequence, you click the Play button on the panel and then drag the circle around the screen with the mouse, bouncing it off the walls of the screen like a ball in a squash court, if you wish. You can issue a keyboard command that clears all working windows on the screen so you can see the sequence unimpeded (see figure 3). While the program is in the Play mode, the circle-sprite will continue to cycle through those motions you just gave it. From that moment on, you are a giver of life—an animator!

Real-time animation is useful for "motion sketching," but soon you will be designing sequences that demand the interaction of many elements, moving at different rates. VideoWorks' Tweak window is an incremental motion generator that lets you control precise frame-by-

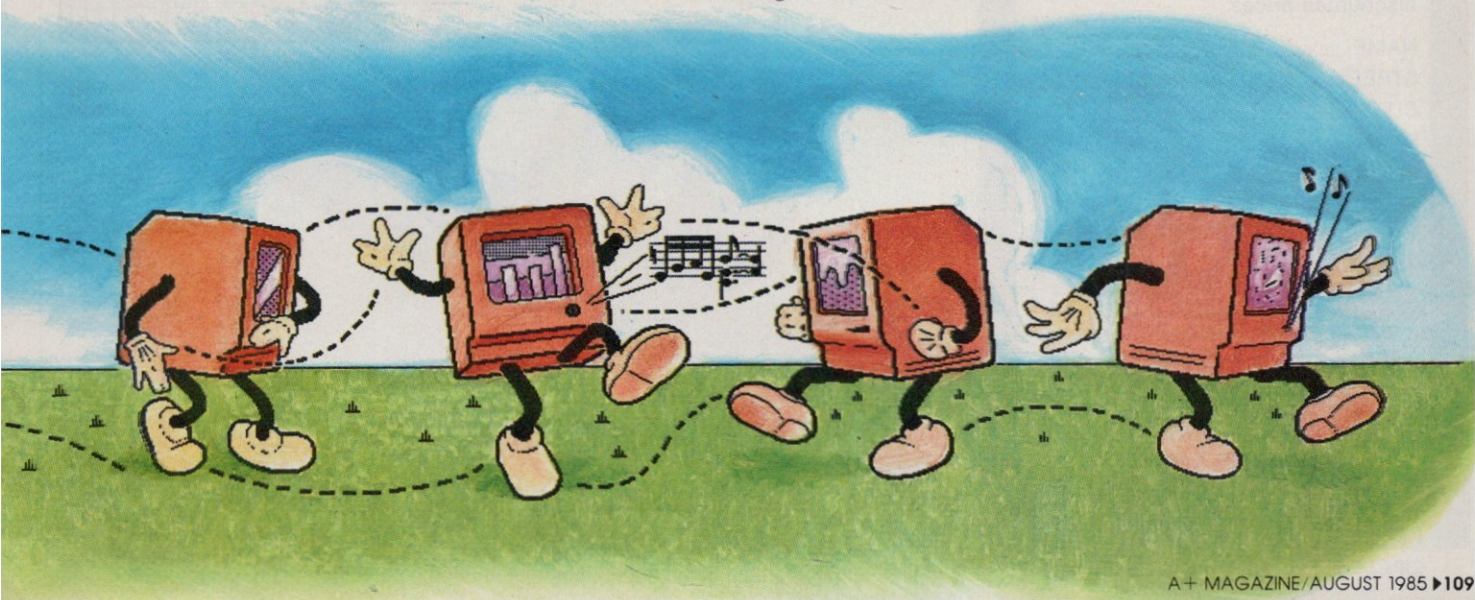

**YOUR
SOURCE
For**

Macintosh™
SOFTWARE AND
ACCESSORIES

**BRAND NAME
MAC products at
DISCOUNTED
PRICES.**

**SOFTWARE
HARD DRIVES
MODEMS
DISKETTES
DISKETTE CASES
PRINTERS
CARRYING BAGS
...AND MORE!**

**New products are being added to
our inventory weekly. Call today
for our latest list and prices.**

(404) 446-2295

or

MAIL THE COUPON BELOW

Please send me your latest list of products for the "MAC", along with your discounted prices.

NAME _____
STREET _____
CITY _____
STATE _____ ZIP _____
PHONE _____

DESKTOP

software center

DESKTOP SOFTWARE CENTER
4115 FRANK NEELY RD., NW
NORCROSS, GA. 30071

Macintosh is a trademark of Apple Computer, Inc

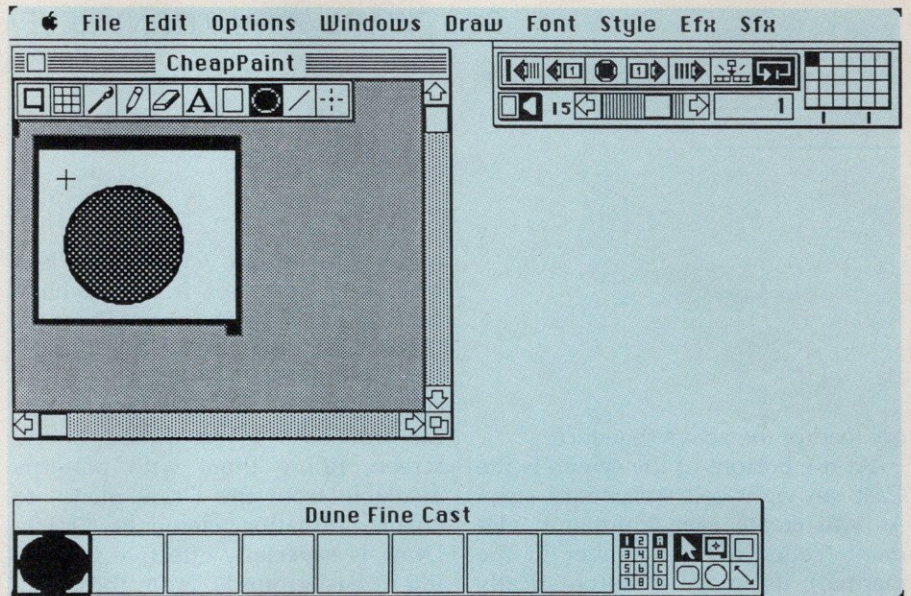

Figure 1

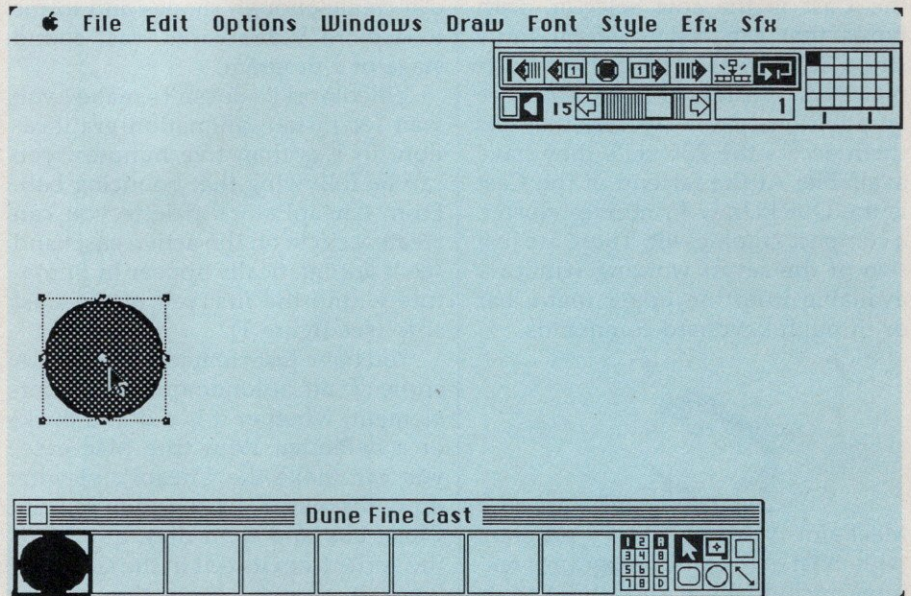

Figure 2

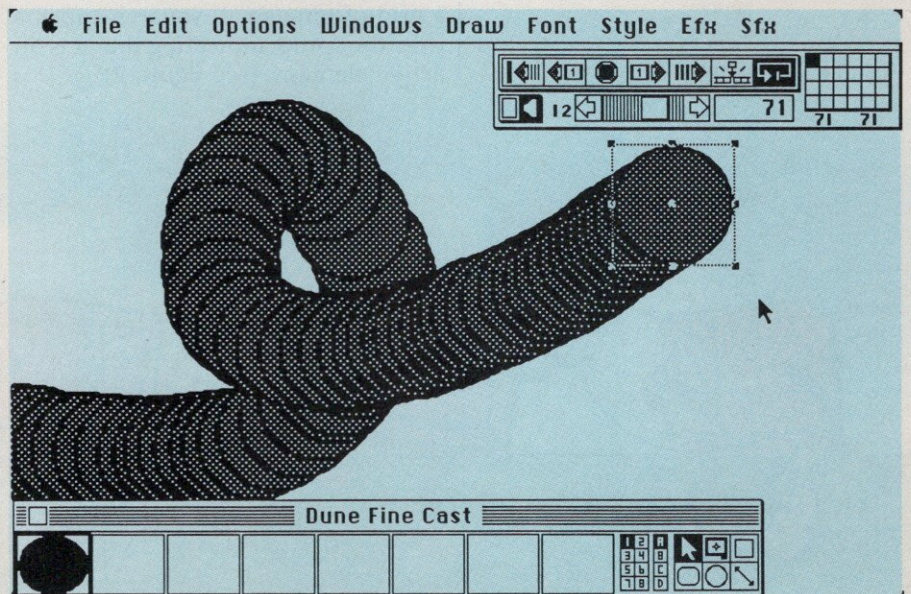
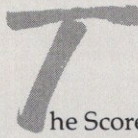

Figure 3

CIRCLE 151 ON READER SERVICE CARD

frame movements by directing an x/y vector line in a mouse-operated panel. The Tweak function affects whatever element is active on the screen. Activating each element in turn—by clicking on it—and then tweaking it frame-by-frame gives you the control to achieve smooth choreography.



The Score is the editing bench and continuity chart for VideoWorks. It is a resizable window divided horizontally into channels, with the sound channel on top and animation channels from A to X below. Each channel, or row, shows the progress of one animation element, whether it is an active sprite or a static background. A simple code in the channel indicates the track of the element. Three toggles allow you to choose variations of the code for display, to trace the elements' identities and motions. The channels also have vertical divisions, representing the frame numbers, extending to more than a thousand frames for a sequence. The maximum number of frames in a sequence is 23,000 on a 512K Macintosh.

All animation elements occupy channels A to X in the order that you create them, and up to 24 different elements can share the screen at the same time. In the Score you can cut and paste movement passages with the ease of word processing—true "motion processing." The larger and more complex an element is, the slower it will move, and the longer it will take for patterns and textures to refill. According to Marc Canter, president of MacroMind, that slowness is due to the limitations of the Macintosh's architecture. The computer does not contain a VLSI special graphics hardware chip for anima-

Figure 1: You can enlarge the easels within CheapPaint to accommodate larger-size sprites. When the drawing is complete in the easel, its image appears in a cell in the Cast.

Figure 2: You drag the image from its cell in the Cast, and the sprite appears on the screen. The attribute squares show that it is active, and the mouse pointer is on the central square, for moving the sprite without changing its shape or size.

Figure 3: I moved the sprite in real-time animation by dragging it while the Play function was on. Using the No Erase and the Matte choices from the Efx menu, I had it leave a trail.

COPY II MAC™

- **BACKS UP PROTECTED SOFTWARE!**
Copy II Mac does more than just sector copy. Its bit copy program has the built-in power and flexibility to handle most protection schemes* *automatically!*
- **INCLUDES THESE POWERFUL UTILITIES:**

- Sector Copy
- Make Files Visible/Invisible
- Sector/File Editor
- Format/Verify Disks
- Repair Damaged Disks
- Copy Protect/Unprotect
- Undelete Files
- Copy Files/Disk

System Requirements: 128K Macintosh, 1 drive.
(Two drives and 512K fully supported!)

*We update Copy II Mac as often as needed to handle new protections; you as a registered owner may update at any time for 1/2 price! (To update, just send your original disk and \$20.)

Increase the power of your
MACINTOSH . . . use **COPY II MAC** ONLY
\$39.95
PLUS \$3.00 SHIPPING/HANDLING

CENTRAL POINT
Software, Inc.

9700 SW Capitol Hwy., #100 / Portland, OR 97219

(503) 244-5782
M-F 8-5:30 (W. Coast Time)



CHECK, COD WELCOME
(Prepayment Required)

Versions also available for IBM, Apple and Commodore 64!

These products are provided for the purpose of enabling you to make archival copies only.

CIRCLE 184 ON READER SERVICE CARD

Be MacColorful

MacDraft™ Now Taking Orders!
 **\$198**
 Fantastic new product from IDD! More powerful features than MacDraw™—plus CAD capabilities. *Templates coming soon! See IDD's ad in this issue.*

Diskettes **\$29**
 3 1/2" Diskettes - 10 Pak with Jackets!
 Call for Quantity Prices

Diskette Desk Cases **\$17**
NEW!! Micro Disk Minder 36" Holds 36 3 1/2" Diskettes

Colored Labels — Keep Your Disks Straight with Colored Labels—Red, Blue, Green, Yellow, Orange, in both 3 1/2" & 5 1/4" Formats. **CALL!**

MacJackets™ — Color Organize and Protect your diskettes — **NEW!! CALL for price.** We can imprint your logo! Colored Disk Jackets for 3 1/2" Diskettes — Anti-Static, Tough as Nails Tyvek™ for safe transport, and to keep out dust, dirty fingers and spills. Red, Blue, Green, Yellow, Orange

MacBag™ Reg. \$100 **\$69** each Navy - Black - Grey - Wine - Tan: Custom made to hold your Mac and all accessories! □ Imagerwriter™ Bags — Also! (10" or 15") **CALL!**

Disk Drive Cleaners - Print Head Cleaners — **CALL for Full Line!**

Color Laser-Cut Continuous Feed Paper

A Cut so Neat they'll think it's Sheet!!
 You need continuous feed to keep your graphics printing aligned. We can make your package any color combination or size you want. Try a Rainbow Pak!

20 lb. □ White □ Pink □ Green □ Blue — In any combination
 300 sheets 500 sheets Rainbow 500
 □ \$11.00 □ \$13.00 □ \$15.00

Correspondence Quality Heavy Bond
 300 sheets: □ \$14.00 500 sheets: □ \$17.00
 □ 12 Shades Available!

Envelopes to Match Color and Grades of Paper — Call for Prices

Give your printouts and report covers distinction!

COLORPRINT® by ESOF **\$39**
 REG \$50
 Color your Imagerwriter MacPaint™ Printouts. Automates printing of up to eight individual color overlays at time. Make color MacPaint pictures as seen in MacWorld.

Ask about Ribbon Discounts with purchase!

Imagerwriter™ Ribbons Black **\$4.50** each
 Color Ribbons: □ Red □ Blue □ Yellow & More - **\$6.50** each



We can pack any Combination you like, & Custom Ink your color. **Quantity Discounts**

Printer Stand **\$16** each
 For your Imagerwriter or any printer. Has Anti-Static Foam protection, and will allow 500 sheets under printer.

Mouse Pads **\$8** each
 Keep your Mouse off your furniture, clean, and with good traction — a must for every mouse: 5 colors.



PURCHASE ORDERS WELCOME NO SALES TAX!



  **The CREATIVE COMPUTER Company**

All Prices and Information correct to the best of our ability. Prices or availability subject to change without notice.

CALL TOLL FREE: (800) 325-1529
 OR CALL (800) 555-1212 FOR NEW 800 NUMBER
HOT LINE: (503) 362-5147

Shipping, Insurance, Handling at Cost
 \$3.00 Minimum

Creative Computer
 620 Elm Street
 Albany, Oregon 97321

CIRCLE 131 ON READER SERVICE CARD

The first library

We've written more Macintosh programs than any other software company:

Microsoft® Multiplan®, Microsoft File, Microsoft Word, Microsoft BASIC and Microsoft Chart.

But we can't write everything. So when we find something really excellent out there, we publish it.

Every program has to sweat out an interview.

Because we've begun to build up an impressive body of Macintosh work, we founded Microsoft MacLibrary™ programs to house them.

Programs for business, for learning, for fun.

And these disks can't just roll in off the street. Each program has been exhaustively reviewed, previewed, and scrutinized.

We look for highly original, highly useful programs that are easy to learn and use.

Our first releases.

The renowned programming language, Logo, has now come to Macintosh. A mainstay of university curriculums,

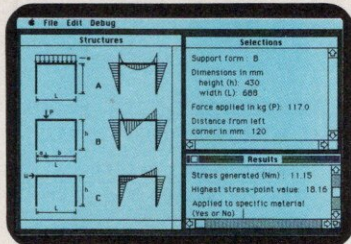

Logo by Logo Computer Systems Inc.

Logo teaches programming concepts, techniques, and problem solving strategies. And it makes it all fun to boot. Intriguing enough to challenge even an advanced programmer—or motivate a child—this is Logo's latest

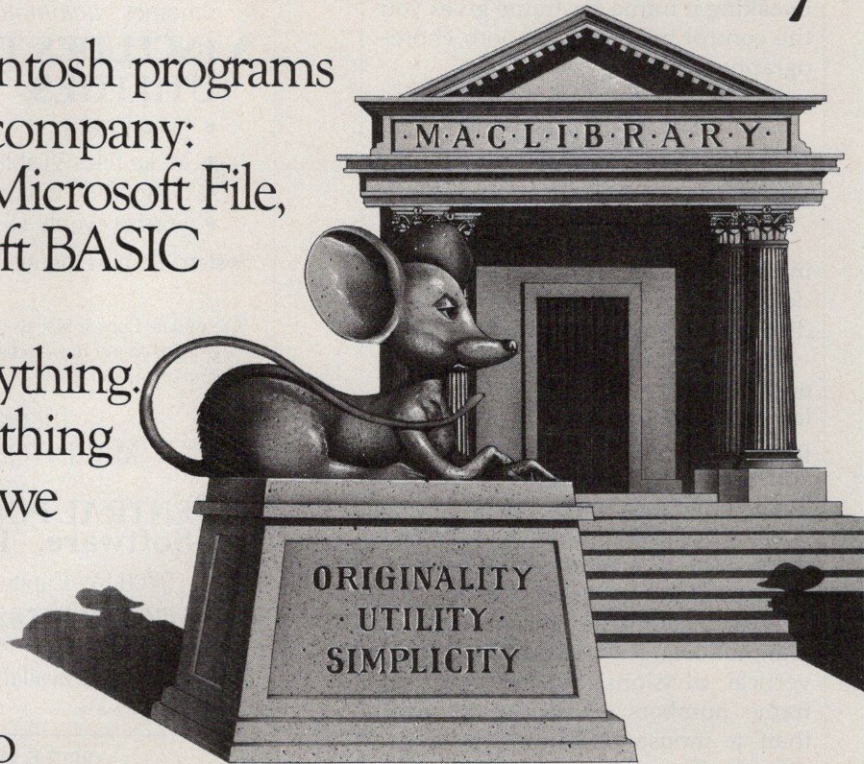

dedicated to Macintosh.™

generation. And it takes full advantage of all of Mac's easy to use features.

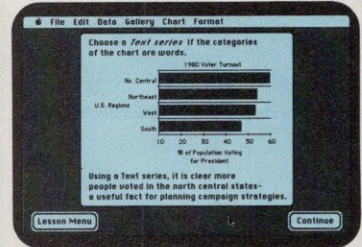
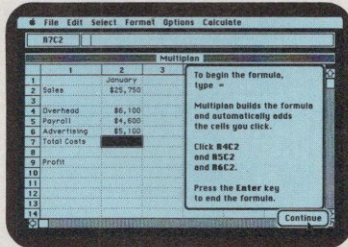

Learning Microsoft Multiplan[®]
and Microsoft Chart by Micro Courseware Corp.

Learning Microsoft Multiplan and Microsoft Chart is a superb interactive instructional program by Micro Courseware Corp.

It walks you through the basics and into the intricacies of these sophisticated

business tools. Teach yourself quickly and simply how to produce presentation quality graphics. As well as what-if projections, portfolio managers, and financial models.

Finally, there's Entrepreneur™ by Harvard Associates. You're in the software business, competing against one to eight other capitalists of either the human or computer persuasion. With 36 months to boom or bust, prosper or squeak through.

Check out a few programs.

For a list of your nearest dealer stocking MacLibrary software, just call (800) 426-9400. Or in Washington State, Alaska, Hawaii and Canada, call (206) 828-8088. We think you'll be impressed. Because making it into MacLibrary speaks volumes.

**Protect
the fruits of
apple!**

Call (800) 847-4176

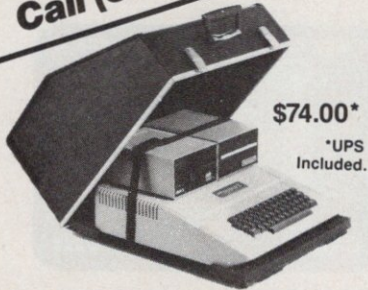

\$74.00*

*UPS
Included.

IIfx Foam Padded Carrying Case
with
Removable Cover



**Macintosh
Carrying Case
\$104.50***

*UPS Shipping Included.

IIfc Foam Padded Carrying Case



\$179.50*

*UPS Shipping Included.

**Call for Complete
Computer Case Catalog.**

For
Fast
Service!



CREDIT CARD CUSTOMERS
CALL TOLL FREE
800-847-4176
(outside N.Y. State)



Fiberbilt
CASES, INC.

601 West 26th Street
New York, New York 10001-1199
(212) 675-5820 (N.Y. State only)
(800) 847-4176 (Toll Free)

CIRCLE 159 ON READER SERVICE CARD

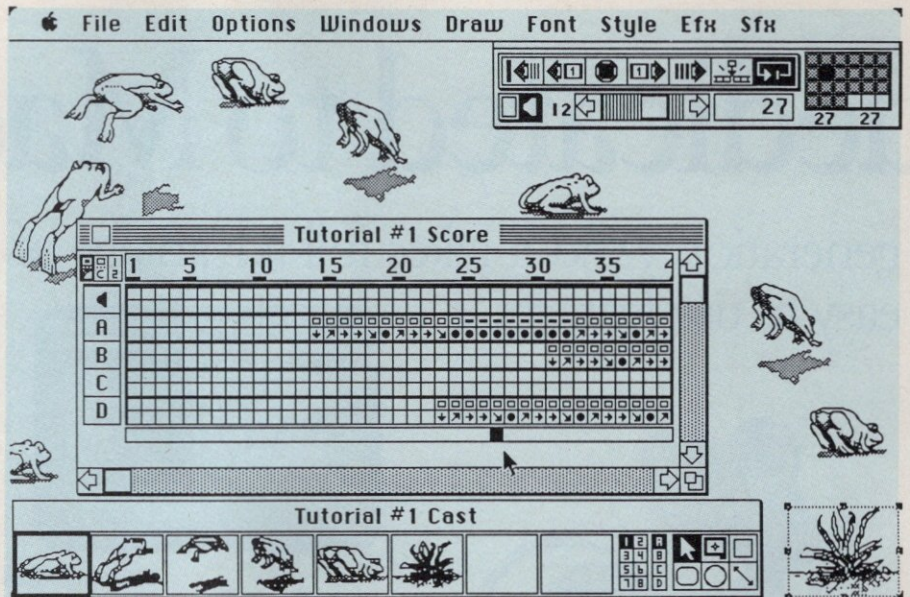

Figure 4

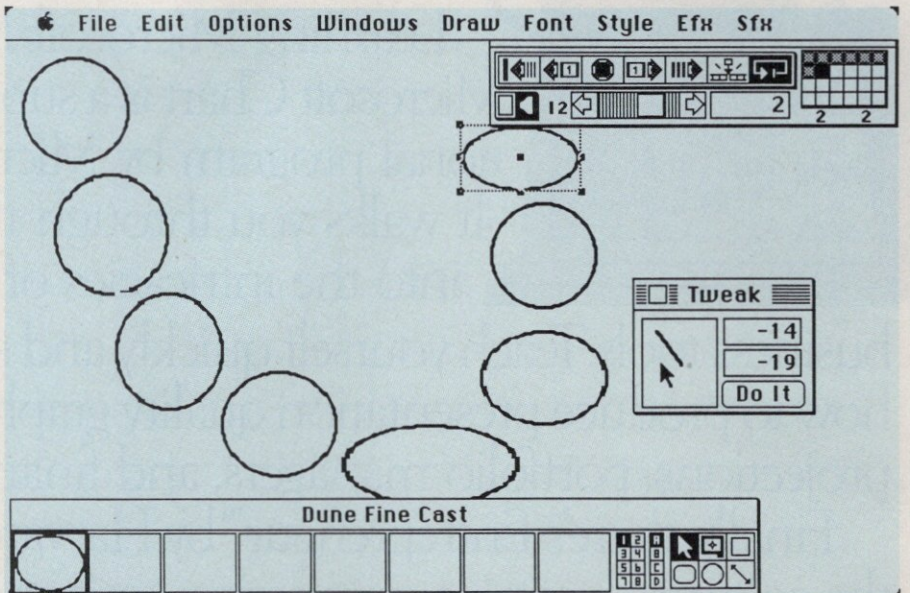

Figure 5

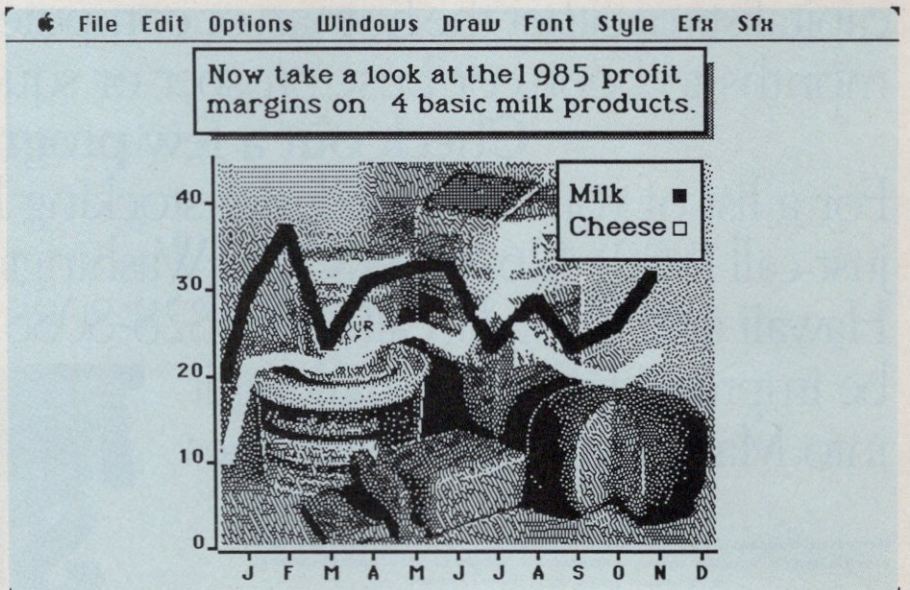
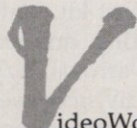

Figure 6

tion, so all movement must be software-driven.

One of VideoWorks' most powerful features is the Playback function. Located at the bottom of the Score window, the Playback Head is a black square that runs along its own channel, called the Playback Bar, pacing the action when a sequence is playing or marking where you pause. When you use the mouse to point anywhere on the Playback Bar, the Playback Head pops up, whether the sequence is playing or at rest. Whatever elements occur at that frame in the sequence will appear on the screen. You can drag the Playback Head to the right and to the left, and the elements will move forward and backward. If a sound track corresponds to that section, it will play as well. Just as professional animators might test their characters' movements by flipping a stack of drawings back and forth, you can sketch, shape, and fine-tune your designs quickly and easily with VideoWorks' Playback mode.



VideoWorks' three tutorials detail the advanced features of the program. Tutorial 1 shows you how to create a realistic sequence by making a frog leap and then, by cutting and pasting in the Score window, unleashing a herd of frogs jumping across the screen (see figure 4). Tutorial 2, along with the Efx Demo sequence, demonstrates how you can manipulate foreground and background priorities in several ways by using the Efx menu. Tutorial 3 shows you how to further modify a sequence by putting borders on the animated text blocks of a sales presentation.

What makes good animation so

Figure 4: In this sequence from Tutorial 1, a fully developed Cast is running with several figures on the screen at the same time, and the bush has been activated for modification. The Score is open, showing channels with motion code, and the pointer is at the Playback Head.

Figure 5: I moved this sprite with the Tweak generator for precise positioning and then stretched and squashed it in each position to emulate a bouncing rubber ball.

Figure 6: You can enhance and dramatize business graphics with animation. A graph in motion is sure to capture your clients' attention. Which line will make it to the top? A digitized image for the background gives the graph customized identity.

A computer store's service at mail-order prices.

Because we're both.

Our commitment to service is why so many private individuals, schools and Fortune 1000 companies choose Micro City. If in the Chicago area, please visit us at 24W500 Maple Ave., Naperville.



HARDWARE FOR APPLE	
DISK DRIVES FOR APPLE	
Super 5 Direct Slim Drive II+ //e	\$169
Super 5 Dir. Slim Drive //c	175
PACE AP-50 Full Height II+ //c	159
PACE AP-50 Full Hgt. //c	165
Mitsuba Drive for Mac	259
GENERIC HARDWARE	
16K Ram, II+	42
Z-80 Card, II+ //e	42
Cooling Fan, 2 outlets, Surge Protect, II+ //e	35
Joystick, fire button, (Spec. II+ //e)	29
Computer Case, II+	59
Replacement Keyboard, II+	69
Case w/ built-in Numeric Keypad	119
RF Modulator	19
Power Strip, Surge Protect, 6 Outlets	19
ADVANCED LOGIC SYSTEMS	
CPM Card, II+ //e	249
Business Card T-Maker, II+ //e	269
Z Engine II+ //e	129
Smarter II, II+ //e	129
Dispatcher II+ //e	109
Printer Mate, II+ //e	59
ALPENLITE	
Mac Pro Carrying Case	59
//c Pro Carrying Case	59
AMARAY	
Media Mate 5	14.95
Media Mate 3	14.95
APPLIED ENGINEERING	
	CALL
CH PRODUCTS	
Mach II Joystick (Spec. II+ //e) //c	38
Mach III w/ fire button (Spec. II+ //e) //c	45
Paddlestick Spec. II+ //e //c	38
CALIFORNIA COMP. SYS.	
Clock Calendar	89
7711 Async Ser. Interface	99
DISCWASHER	
Printer Port Adaptor //c	99
KENSINGTON MICROWARE	
System Saver Fan, II+ //e	65
Accessories: Surge protect	45
Accessories: Starter Pack	69
KOALA TECHNOLOGIES	
Koala Pad w/SFT //e //c	69
Muppet Learning Keys w/SFT //e //c	55
Gibson Light Pen	149
MacVision Digitizer	219
MICRO SCI	
80 Col w/64K //e	109

MICROSOFT	
SoftCard II	\$249
Premium SoftCard //e	269
Macenhancer	179
MICROTEK	
Dumpling-GX	79
64K Ram Card, II+ //e	159
128K Ram Card II+ //e	219
Magnum 80me 80 Col	115
MITSUBA	
80 Col w/64K //e	99
Controller Card II+ //e	45
MOUSE SYSTEMS	
A+ Mouse //e, Mac	79
ORANGE MICRO	
Grappler +, II+ //e	89
Buffered Grappler +, II+ //e	159
Bufferboard II+ //e (Spec. your Interface)	79
Serial Grappler +, II+ //e	99
Bufferpak / Ser. Grappler Combo	179
Orange Interface, II+ //e	59
PERSONAL COMP. PROD.	
Appli-Card 6 MHz/64K memory II+ //e	199
Appli-Card 6 MHz/64K RAM Extender II+ //e	349
PRACTICAL PERIPHERALS	
GraphiCard (Graphics int.)	79
SerIAL (RS 232)	109
Switchport //c	89
Pro Clock	109
Microbuffer II, spec. printer	109
16K spec. par/ser	109
32K spec. par/ser	119
Microbuffer II+ (both par & ser)	119
16K	139
32K	149
64K	169
Microbuffer In-Line External	189
32K (spec. par/ser)	189
64K (spec. par/ser)	219
Microbuffer/E Internal for Epson Printers	119
16K Parallel	119
32K Parallel	139
64K Parallel	179
8K Serial	119
16K Serial	129
32K Serial	149
QUADRAM	
eRam 80 (80 Col. 64K //e)	109
SWEET MICRO SYSTEMS	
Mockingboard A (Music)	89
Mockingboard B (Speech)	79
Mockingboard C (A+B)	139
Mockingboard D //c	159
TG PRODUCTS	
Paddles (spec. II+ //e)	32
Select-a-Port	39
Track Ball	49

TITAN SYSTEMS	
64K Ram Card	\$159
128K Ram Card	199
64K + 80 Col. //e	189
128K + 80 Col. //e	289
192K + 80 Col. //e	349
Accelerator //e, II+ //e	229
TRACK HOUSE	
Programmable 10-Key Numeric Keypad for //e	139
VIDEX	
Ultratram (132 Col)	249
Videterm VT600 (80 Col)	185
VT601 (80 Col + SS)	205
VT602 (80 Col SS + Inv)	209
Lower Case Chip	25
Visicalc Preboot	45
Apple Writer II Preboot	22
Ult. Visicalc Preboot	54
Ult. Applewriter Preboot	24
PRINTERS	
ABATI	
LQ Parallel	319
BROTHER	
HR-15XL, LQ spec. par/ser	369
HR-35P, Letter Quality	699
COMREX (Div. of Epson)	
CR-IIe, LQ parallel	369
CR-IIIe LQ serial	379
Keyboard	169
Tractor	99
EPSON	
NEC SPINWRITER	
NEC 3510, Serial	1050
NEC 3530, Parallel	1050
Bi-Dir. Tractor, 3500 Series	169
Cut Sheet Feed, 3500 Series	689
OKIDATA	
PANASONIC	
KX-P1090, Parallel	209
KX-P1091, Parallel	289
KX-P1092, Parallel	369
KX-P1093 Par/Ser	519
SILVER REED	
EXP-400 LQ (spec. Par/Ser)	259
EXP-500 LQ (spec. Par/Ser)	309
EXP-550 LQ (spec. Par/Ser)	409
EXP-770 LQ (spec. Par/Ser)	689
TOSHIBA	
P1340 LQ (spec. Par/Ser)	529
P1351 LQ (spec. Par/Ser)	1219
P351 LQ, Par.	1229
P1351 Bi-Direct Tractor	159
P1351 Auto Sheet Feeder	659
MONITORS	
AMDEK	
V300 Green	139
V300A Amber	149
Color 300 (Comp)	249
Color 500 (RGB Comp)	329
Color 600 Hi/Res RGB	419
Color 710 Super Hi, RGB	539

COMREX (Div. of Epson)	
CR-5650, Green or Amber	\$109
CR-6700 Hi/Res RGB	399
SAMSUNG	
MD1251D, Hi/Res, Green	115
MD1251D Hi/Res, Amber	119
CD1451D Color Comp	229
TAXAN	
12" Hi/Res Amber	139
12" Hi/Res Green	129
410-08 RGB Int, II+	79
410-8064 RGB Int, //e	189
MODEMS	
HAYES	
Smartmodem 300	159
Smartmodem 1200	389
Smartmodem 2400	619
Micromodem //e w/SFT	159
Smartmodem 300 w/SFT //c	179
KENSINGTON MICROWARE	
Accessories: Portable Modem for Mac //c	109
MICROCOM	
ERA 2 for //e //c	349
Macmodem w/sft	409
Macmodem 2400	629
NOVATION	
Smart Cat Plus 300/1200 Baud w/Software for Mac	299
J-CAT	89
Apple Cat II	189
212 Apple Cat Upgrade	219
212 Apple Cat System	349
Expansion Module	29.95
PROMETHEUS	
Promodem 1200 Ext.	309
Promodem 1200A w/Software for II+ //c	309
Promodem 1200 w/ Mac Pac	399
ZOOM TELEPHONICS	
Zoom Modem //e Apple	139
DISKETTES	
BASF	
SS DD Box of 10	16.95
SS DD 3.5" Box of 5	16.95
BONUS	
SS DD Box of 10	17.95
MAXELL	
SS DD Box of 10	19.00
VERBATIM	
SS DD Box of 10	19.95
DS DD Box of 10	26.95
SS DD 3.5" Box of 10	34.95
Disk Drive Analyzer	29.95
Disk Drive Head Clean. Kit	8.95
Cleaning Disks - 10	12.00
XIDEX	
SS DD Box of 10	14.95
DS DD Box of 10	16.95
SOFTWARE	
	PLEASE CALL!

Please call for **FREE catalog** and **CURRENT LOW PRICES!**

1-800-548-8244 (Orders Only)
312-810-0037 (Customer Service, Product Info, Catalog Requests & Illinois Orders)

Hours: Mon - Fri 8:30 - 5:30, Saturday 10 - 4

Check, money order, Visa, MasterCard or American Express (include # & exp. date). \$2.50 shipping & handling in Continental U.S. (Alaska, Hawaii & foreign add 5%, min. \$5.00). Personal/company checks allow 2 weeks. Please add 2% for credit card use. Illinois residents add 6.25% sales tax. School & corporate P.O.'s welcome. Dealer inquiries invited. Prices subject to change.

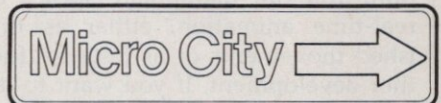

A Division of Pace Systems, Inc.



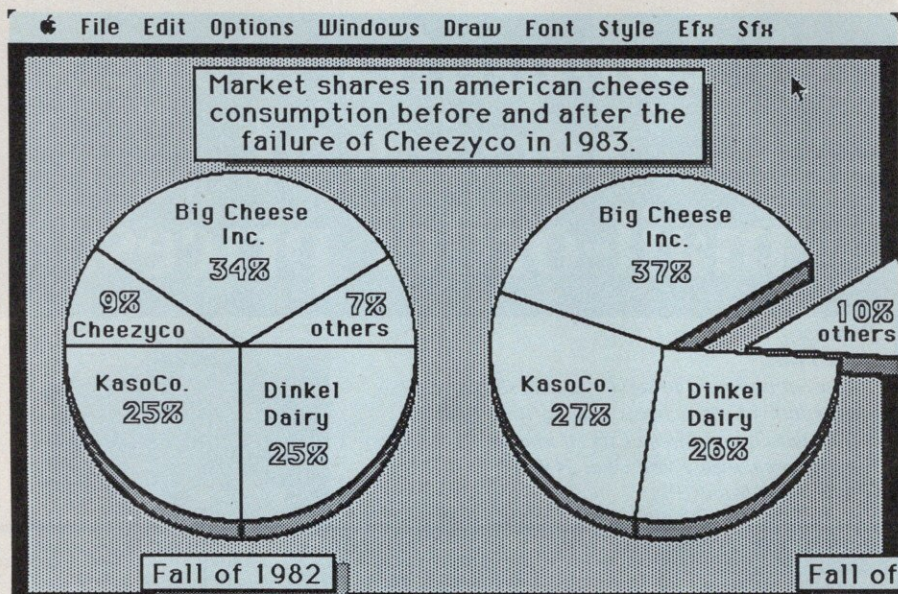

Figure 7: Animation will put sky in your pie chart as the wedges float in from off-screen, stamping the two annual results with authority.

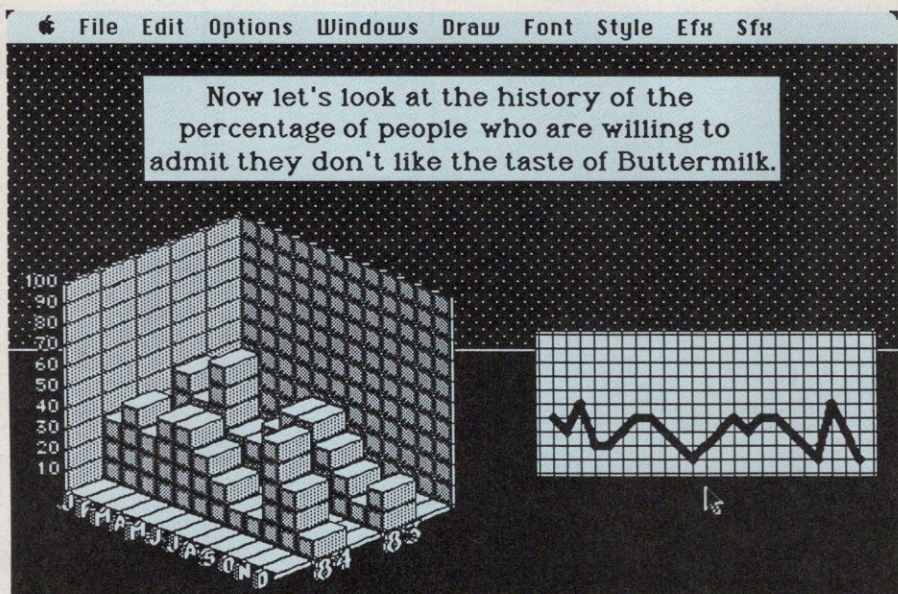

Figure 8: Three-dimensional comparisons can march in time in this cube grid, as the building-block elements show the totals. The sound track matches the lows and highs with an electronic tone.

vital, vivid, and memorable? Not movement alone. Like us, animated objects should be subject to gravity, velocity, and inertia. Their character is revealed by the way they move. VideoWorks offers an unprecedented degree of expressive control for "sculpting" life into computer animation. You can manipulate sprites in real-time animation, either as finished movements or as tests for further development. If you want to do frame-by-frame animation, you can use the Tweak function or drag the sprites with the mouse, from position to position. All of these methods permit immediate playback of a movement to see how well it works, and, equally important, changes to shape

the movement more precisely and expressively are easy to make.

The nine squares, or attributes, that lie over an element when it is active are more than symbols. They are graphic identity coordinates that you can use as shape-modification toggles. By dragging corner and side squares, you can enlarge the sprite or stretch it in different directions. You can move your bouncing ball step by step and change its shape frame by frame, so that when it's in motion, it will seem to be reacting to flight like a real rubber ball (see figure 5). By enlarging and shrinking the ball frame-by-frame, you'll make it appear to come closer and then recede. In Tutorial 1 you can stretch the bush verti-

cally a little bit in each frame. When you play the sequence again, the frogs will be hopping by a bush that grows taller by the second.

Some shaping modifications, such as trace edges, flipping, mirroring, or spray painting for shadows are unavailable within CheapPaint, but Art-Grabber makes it easy to port the sprite or background to MacPaint and bring it back. If the MacPaint program is equipped with T/Maker Graphics' ClickArt Effects, full rotation, distorting, and perspective stretching will be available as well.

T

he Art disk in the package is not only good clip art, but also a thoughtfully designed aid for advanced animation techniques. Files include dancers, horses, backgrounds, robots, men and women walking, and even bugs—but then what computer program doesn't have bugs? The chart kit contains systems for constructing animated business charts, with arrows, x/y axis scales for graphs, divisible wedges for pie charts, and a three-dimensional-cube grid (see examples on following pages). The three "Cheez Biz" sequences in the Movies disk (figures 6–8) use these systems to demonstrate how animation can enhance business presentations.

The perspective file helps you create objects and backgrounds in depth. The "PerCar" movie, with its videogame action, uses the shadowed perspective building blocks to show you how convincing background-to-foreground movement can be simulated in simple ways. All the files in this disk include text that explains the most effective uses of the drawings.

You can animate your technical and scientific demonstrations with VideoWorks, as demonstrated by the "Ear" illustration on the Movies disk. When graphics are too complex to be drawn economically on the Macintosh, you can import any MacPaint image or create one with a digitizer. Thus, for instance, a map of the ancient world can have arrows moving across continents to dramatize migrations, and an electronic-circuit diagram can show currents flowing and gates opening and closing. For education, training, and sales needs, VideoWorks animation

Introducing The Macintosh Office support group... at some very supportive prices!

Supplying software for The Macintosh Office is our business and our business exclusively. That's why we stock only the finest programs from the nation's leading manufacturers at the lowest prices possible. All programs listed are fully guaranteed both by us and the manufacturer. A four dollar shipping charge will be added to the purchase price but there will be no charge for Master Card, Visa, or American Express. A 6% Sales Tax will be added to California residents only and all deliveries will be made within 10 days after placing your order. So if you're looking for quality and price, with some of today's top software programs, just give us a call. We're FLASHWARE and we'd like to hear from you. **1-800-547-0900** (Nationwide) **1-800-932-4900** (California only) (Product price shown in TV screens.)

- | | | |
|---|---|--|
| <p>CALL HabaDisk by Haba — Double density 800K 3.5" disk drive. Bundled with some exciting new programs. A sneak preview for Flashware customers.</p> | <p>CALL Quartet by Haba — Spreadsheet, graphics, database, and text editing functions. Up to 10 times faster than other spreadsheets. (Runs on 128K).</p> | <p>119 Advanced DB Master by Stoneware — A complete database management system which holds more information than any other system today.</p> |
| <p>299 HabaDisk by Haba — 400K 3.5" external disk drive. Includes Habadex, WindowDialer and Quick Finder.</p> | <p>189 Ensemble by Hayden — An integrated package which includes spreadsheet database, and word processing. Runs on 128K with one Drive.</p> | <p>119 PFS File and Report — Are simple software programs to help you organize your business and require no computer experience.</p> |
| <p>119 Multiplan by Microsoft — A spreadsheet of dazzling analytical power and graceful simplicity. Move mountains of figures with a click.</p> | <p>49 HabaCheck — A home accounting package. Write checks, analyze cash flow, produce income statements and more.</p> | <p>89 MacStation by MicroRain — Save desk top space. Has plenty of storage space for a printer, disc drive, modem and manuals.</p> |
| <p>80 Chart by Microsoft — A presentation quality graphics program that allows you to chart anything. Pie charts, bar charts, line, etc.</p> | <p>39 WindowDialer by Haba — Will work simultaneously with any program you're using. Dial up to 200 numbers automatically.</p> | <p>31 Mind Prober by Human Edge — A software program designed to reveal a person's hidden thoughts. If Freud only knew...</p> |
| <p>119 File by Microsoft — A professional data manager. Not only organizes and retrieves detailed information but can customize your own forms.</p> | <p>239 Helix by Odesta — An interactive information system that lets you control the shape and form of information according to your needs.</p> | <p>79 Mac-Spell-Right by Assimilation Process — Get the power of Websters Dictionary and Rogets Thesaurus with the click of a button.</p> |
| <p>119 Word by Microsoft — Mac's word processing program. Capable of merging mailing lists and will "window" up to 4 pieces of work.</p> | <p>160 OverVue by ProVue — A database management system which will enable you to organize mailing lists, inventories.</p> | <p>239 MacVision (a digitizer) by Koala — Digitize pictures or objects. Video camera required.</p> |
| <p>99 Basic new version by Microsoft — Put control buttons in windows, invent menus for a menu bar and dive into Mac's graphics.</p> | <p>89 Layered — Will schedule, keep track, analyze, and report, the cost efficiency of your business. Coordinates time and use of your people.</p> | <p>29 Infocom Games — Zork I · Zork II · Zork III · Hitchhiker's Guide to the galaxy · Infidel · Enchanter · Starcross · All \$29.00.</p> |
| <p>89 Dollars and Sense by Monogram — A home accounting package. Just right for the small business. Bar and pie charts, etc.</p> | <p>89 Mighty Mac by als — A comprehensive desktop tool. Replaces your calendar, appointment book, note pad, telephone directory files.</p> | <p>29 Airborne! by Silicon Beach Software — A battle game with the most dramatic and realistic sound generation available on Macintosh.</p> |
| <p>104 1st Base by DeskTop — Create your own files. Enter, edit, sort on multiple fields and produce reports from single or joined files.</p> | <p>85 ThinkTank by Living Vidiotext — Organize ideas in a logical manner. Its flexible outline format creates a spreadsheet for ideas.</p> | <p>35 Verbatim by DataLife — A 3.5" single and doubled sided precision floppy disk.</p> |
| <p>55 1st Port by DeskTop — A communication package which enables you to convert different data formats with a variety of Macintosh programs.</p> | <p>119 MegaFiler by Megahaus — A file management system that lets you file and retrieve information. Mailing lists, orders, invoices, inventory.</p> | <p>179 Maccountant by digital, etc. — Small business accounting/financial package. Prepare ledgers, statements, payables, receivables, and write checks.</p> |
| <p>55 1st Merge by DeskTop — Merge your MacWrite documents, memos, and letters with your own data file to produce mass mailings.</p> | <p>75 MegaMerge by Megahaus — The mail-merge program for MacWrite. Create form letters, print mailing labels, and combine documents.</p> | <p>9 FlashPad — A brand new pad for your mouse. Flashware introduces a larger, more durable way to move your mouse around.</p> |
| <p>220 Mac Lion by CDS — A powerful database management system. Write an order entry system or build an invoicing system, pull down menus.</p> | <p>175 MegaForm by Megahaus — A revolutionary new product enabling you to create any business form. And then will fill them in automatically. (Requires 512K & 2nd Drive)</p> | <p>189 ThunderScan by Thunderware — Digitize any printed image. Forms, half-tones, photos. No camera required.</p> |

FLASHWARE
1-800-547-0900 (Nationwide)
1-800-932-4900 (California only)

CR01



The C for the Macintosh and Apple II

FOR THE MACINTOSH

AZTEC C68k is the most powerful, portable, and professional C compiler and software development system for the Apple Macintosh. It is available in three configurations.

AZTEC C68k-c (Commercial System) \$499

For serious Macintosh developers who want to program in C there is no parallel to AZTEC C68k-c. AZTEC C68k-c produces smaller and faster code in less time than any system benchmarked. The supporting utilities and commands of AZTEC C68k-c create a Macintosh development environment with the power and flexibility needed for producing professional results.

All C features are faithfully supported providing portability with UNIX C and AZTEC C compilers available for the APPLE II, MS DOS, PC DOS, CP/M-86, CP/M-80, TRSDOS, and C64.

Features include: C compiler, 68000 Macro Assembler, modular programming, overlay linker, debuggers, mouse based editor, Z(Vi) editor, SHELL development environment (UNIX was developed to support software development - this environment incorporates the best of UNIX), comprehensive support of the Macintosh including the toolbox to provide straight forward development of Macintosh programs and desk accessories, make, diff, grep, terminal emulator (source), grow (source), desk accessory (source), ramdisk (source), UNIX I/O, MATH, UTILITY, and MACINTOSH run time libraries (source), full support for 512k Mac and Lisa Macworks, 600+ page manual, resource maker, calling C routines from PASCAL, PASCAL from C, and assembler subroutines, no-royalty license.

Manx support includes one year of computer tracked updates and technical telephone support.

AZTEC C68k-d (Developer's System) \$299

AZTEC C68k-d provides a less expensive development system for programmers on limited budgets. AZTEC C68k-d includes C compiler, 68000 Macro Assembler, Linker, debuggers, editor, toolbox support, run time libraries (object), sample programs (source), and a 600 page manual.

AZTEC C68k-p (Personal System) \$199

For students and professionals doing serious non-commercial work. Includes C compiler, Linker, run time libraries, sample programs (source), debugger, and editor. Restricted license.

C-TREE Database (Aztec object format) \$149

C-TREE Database (Object + Source) \$390

FOR THE APPLE II

AZTEC C65/DEV (Developer's System) \$299

This C compiler and software development system comes with C compiler, 6502 assembler, SHELL, overlay linker, UNIX I/O, Screen, and Graphics libraries, editor, utilities, and support for ProDos.

AZTEC C65 \$199

C compiler, 6502 assembler, Linker, libraries, Apple DOS 3.3 support.

AZTEC C65 Personal \$ 99

C compiler and development system. Restricted license.

MANX

TO ORDER OR FOR INFORMATION
CALL OR WRITE:

MANX SOFTWARE SYSTEMS
Box 55 • Shrewsbury, NJ 07701
TX 4995812



**CALL:
800-221-0440
201-530-7997 (NJ)**

TECH SUPPORT - 201-530-6557

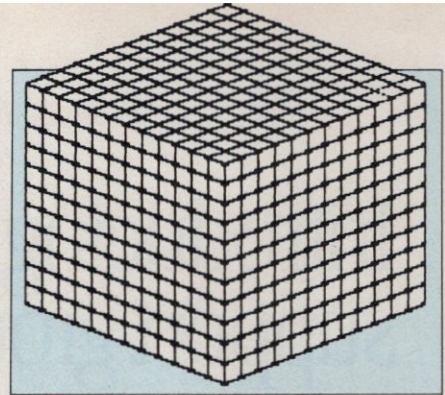

Figure 9: The Chart Kit provides sophisticated building blocks for constructing animated charts, as well as modules for other three-dimensional applications (see figure 10).

can replace costly film and videotape production in many instances. Because of its strong interactive structure, VideoWorks can even emulate applications on videodisc systems.

Sound Effects

More than 82 different sound and musical effects are available in nine submenus, including alarms, bird-calls, helicopters, and Bach. The Mac's four-voice sound generator has never had such a workout! The sound effects are easy to record into the Score. You darken the part of the sound channel above the frames you want the effect to accompany, by clicking and dragging, and then pull down the Sfx menu. Click on any title, and its code will be automatically pasted into the sound channel. While the sound channel is darkened, you can sample VideoWorks' entire sonic repertoire by selecting effects from the menus and then listening as the Playback Head to "strum," or activate, them.

Some spot effects, such as footsteps, drumbeats, and whistles, are only a few frames long. Others, such as the forest fire or the electronic drone, are continuous. The musical effects' duration depends on the lengths of their phrases.

Although the menus do not identify them as such, several effects are "synergistic." They are interlocked with the movement of elements on the screen, and the pitch or key of the sound will rise and fall, and the tempo will slow and quicken in pace with the action.

MacroMind reports that it is working on a program to link MusicWorks compositions to VideoWorks animation, but until that becomes a reality, there is no way to import sound files. The program lacks a fade-in/fade-out function, and it does not let you mix

CP/M-80 and CP/M-86 are trademarks of DRI Macintosh and PRO DOS are trademarks of Apple
TRS DOS is a trademark of Tandy UNIX is a trademark of ATT

CIRCLE 189 ON READER SERVICE CARD

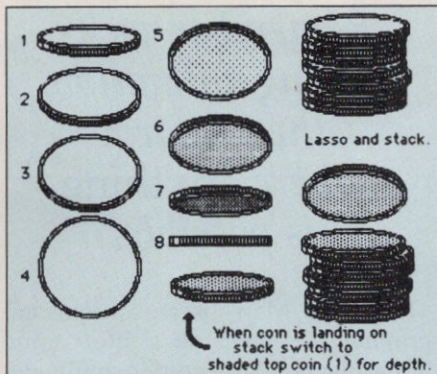

Figure 10: One of the many modules supplied in the Chart Kit for use with three-dimensional applications.

or overlay the sounds, but in minutes you can experience your own sprite whooshing, twittering, exploding, and break-dancing.

VideoWorks' Movies disk will whet your appetite for more. Not only do these 19 sequences demonstrate the variety of animation movements, styles, and strategies that VideoWorks is capable of, but they can also become advanced tutorials.

ANIMATED BUSINESS

VideoWorks has tremendous potential as a serious business tool. You can use the program to bring your business presentations to life by adding animation and sound effects to charts, graphs, diagrams, and text. Any image that can be stored as a MacPaint document can be animated with VideoWorks (you can type ⌘ Shift-3 to save any Mac on-screen image as a MacPaint document). VideoWorks also has a special set of sound effects for use in adding fanfares to business animation.

Imagine how much more impact your presentation would have if the wedges of a pie chart came flying in from the sides of the screen and assembled themselves into a completed chart as you told a client the success story that the chart represented. Or bars could grow on a graph as you explained how sales had grown. For a grand finale, the lines on a graph could zoom off the screen, accompanied by an explosion of dollar signs.

VideoWorks makes producing lively, eye-catching presentations a snap, and an animated presentation will help make your message more memorable. VideoWorks adds an exciting new dimension to business software and gives the Macintosh a tool that is not available on any other system.

Apple and MacPaint are trademarks of Apple Computer, Inc. Macintosh is a trademark licensed to Apple Computer, Inc.

Why touch an Imagewriter?

For under \$130, HanZon can enhance any Epson printer to Apple® standards. Our Universal Interface Card plugs into your Epson MX, FX or RX and delivers total compatibility with any Macintosh™ or Apple IIc software. Even MacPaint™ and AppleWorks. Ask your Epson dealer or call (206) 487-1717.



18732 142nd Ave. N.E., Woodinville, WA 98072

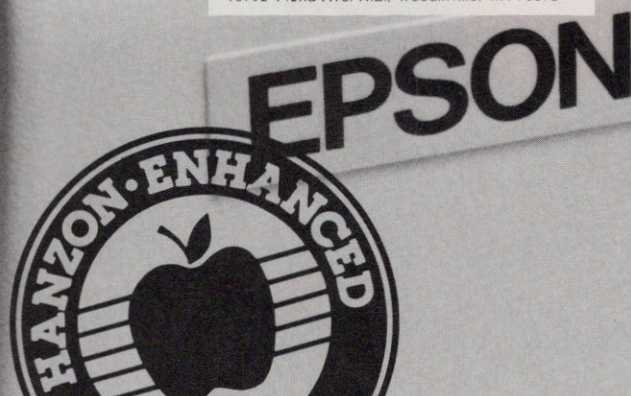

CIRCLE 206 ON READER SERVICE CARD

Brainy Buffer.

Do you press print and wait? And wait? And wait?

Your waiting is over with the Universal Data Buffer — it frees your computer in seconds while it handles the printing of your file.

And the Universal Data Buffer from HanZon is smarter than the average buffer. For one thing it has two inputs—one serial and one parallel, and two outputs—one serial and one parallel. Since all the ports are active, it means the Universal Data Buffer can interface between serial and parallel devices — even at different speeds and protocols. All that is a bonus to its standard function — as a 64K buffer expandable to 256K. The buffer also has operator controls for selecting additional copies, and pausing.

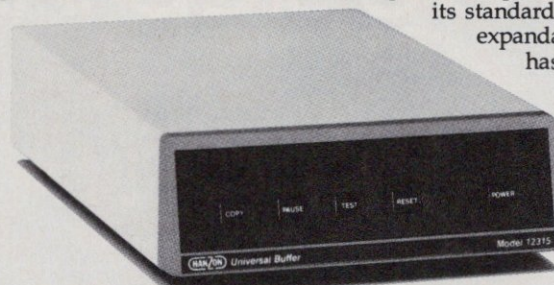
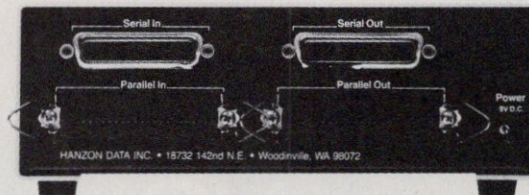

Call HanZon today for your nearest dealer: (206) 487-1717.



HANZON DATA INC. • 18732 142nd Ave NE • Woodinville, WA 98072

Suggested Retail Price: \$385 - 64K Buffer
\$59 - 64K Expansion Module

CIRCLE 216 ON READER SERVICE CARD

GATO™

WW II GATO-Class Submarine Simulation

Spectrum HoloByte Inc.

Macintosh
128K
Now
Available

Now YOU step in!



IBM PC Series (Inc.PCjr)
128K RAM
One Double-Sided Disk Drive
COLOR Graphics Adapter
Graphics Monitor
(RGB recommended)

Apple IIe and IIc
128K RAM
One Single-Sided Disk Drive
Joystick Optional
(64K, 80 Column Cards
available for \$179.95)

SPECTRUM HOLOBYTE, INC., 1050 Walnut, Suite 325, Boulder, CO 80302 (303) 443-0191. Check your local computer store or wherever software products are sold. Dealer Inquiries call: (800) 621-8385 x 262. Written by Paul Arlton and Ed Dawson. IBM and Apple are registered trademarks of International Business Machines Corp. and Apple Computer, Inc. respectively.

*Remember, we're
talking animation,
the art form
where anything
is possible.*

The "1560 Man" is an antique engraving come to life, and "Spacewalk" is a convincingly detailed clip of a space-shuttle mission in action. "Ear" demonstrates applications for scientific and technical subjects, and "BotBot" uses a split-screen format with two views of a robot on the move. "Radar Luv" and "Walk the Dog" reveal the principles of the "traveling" backgrounds professional animators use, even though the manual does not describe them.

You can use the Movies disk as a "ScreenTest" studio. To allow enough memory room, divide the titles and copy each half onto a separate disk; then feel free to examine and disassemble each sequence to see what makes it click. Open up CheapPaint to see how the animation elements were drawn, and modify them there. Look at the Score to see how the movements have been structured. Lay in different sound tracks. Rearrange the action. Cut and paste a character from one movie to another. Who says you can't have a snake charmer on his magic carpet fly by King Kong, or a bubbling skindiver swim along a freeway? Why not create a totally new movie called "Punks in Space" by combining backgrounds, props, and characters from the "Wetlegs," "Spacewalk," and "Dance Fever" sequences. Remember, we're talking animation, the art form where *anything* is possible. +

Anthony Reveaux is a San Francisco writer, editor of Computer Publicity News, and a contributing editor of Artweek; he also teaches film history at Sonoma State University.

PRODUCT INFORMATION

VideoWorks

Hayden Software
600 Suffolk Street
Lowell, MA 01854
(617) 937-0200

List Price: \$99

Requires: Macintosh, 128K or 512K RAM

CIRCLE 395 ON READER SERVICE CARD

CIRCLE 233 ON READER SERVICE CARD

If you thought all small business accounting software was made only for IBM, think again...

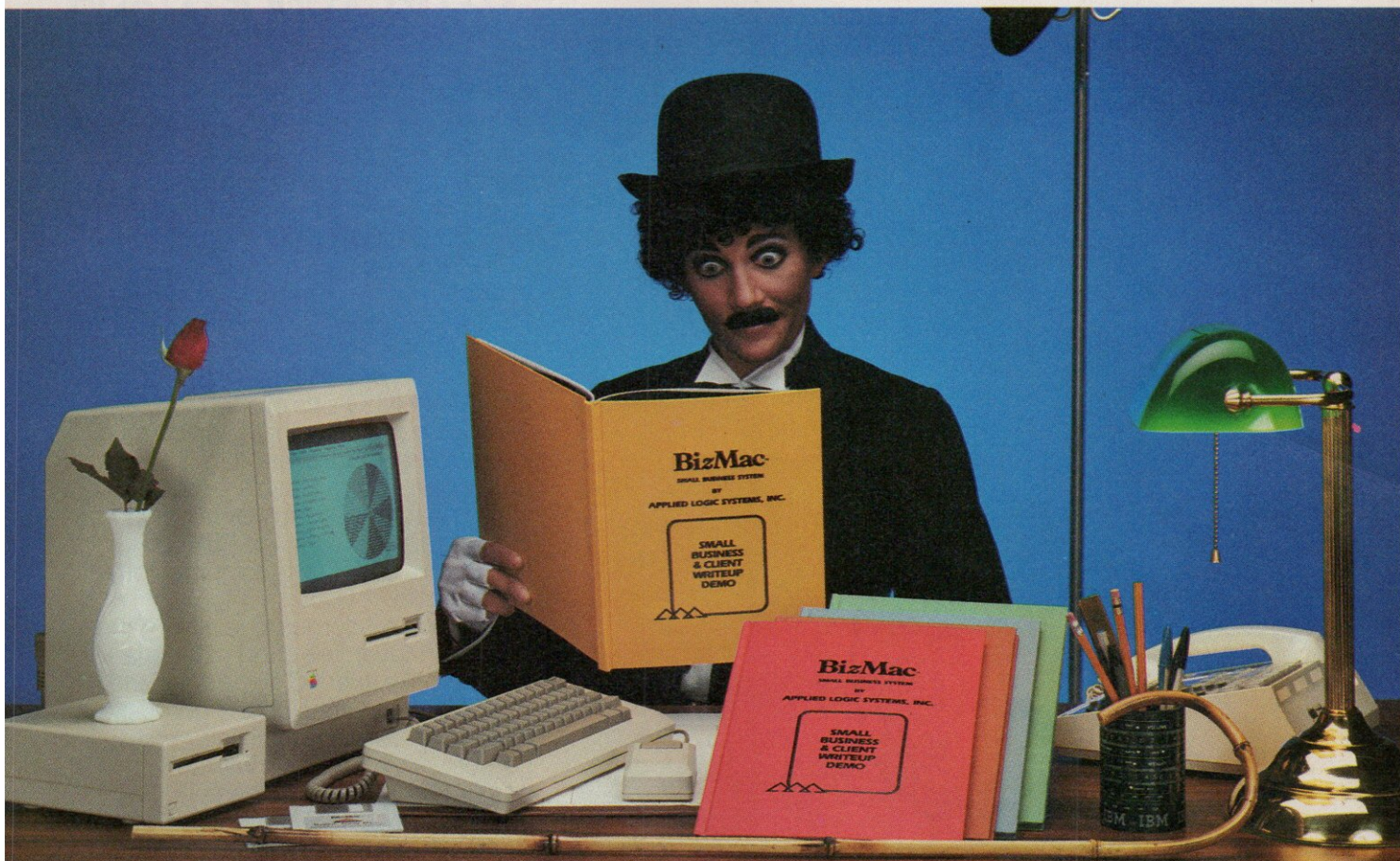

Hmmmmmmmm....

BizMac™

The small business accounting system for the Macintosh™

BIZMAC Small Business System: General Ledger, Inventory, Accounts Receivable, Accounts Payable and two Payroll versions. The complete small business software package specially designed for the Macintosh computer. BIZMAC software enables you to link all parts of the company into a cohesive unit. Single entries in accounts receivable and accounts payable update the other modules automatically. At the click of the mouse, various historical data is at your fingertips, in easy to use form. Built in pie and bar charts make your analysis visual. BIZMAC software gets the job done quickly and efficiently. BIZMAC software, is as "State of the Art" as the Macintosh itself. Every small business needs to have the competitive edge in today's marketplace; for yours, contact your local Apple dealer..... or for more information:

APPLIED LOGIC SYSTEMS, INC.

2614 N. 29th Avenue

Phoenix, Arizona 85009

(602) 272-9355

BizMac™ products are distributed by SOFTWARE PRODUCTS CORPORATION

418 E. Southern Tempe, Arizona 85282

(602) 829-6800

APPLIED LOGIC SYSTEMS, INC. invites accounting professionals to write for information on our new BIZMAC CLIENT WRITE-UP SYSTEM, the efficient way for today's CPA's to keep track of their clients' records.

CIRCLE 176 ON READER SERVICE CARD

© 1984 APPLIED LOGIC SYSTEMS, INC. MACINTOSH IS A TRADEMARK LICENSED TO APPLE COMPUTER, INC. BIZMAC SMALL BUSINESS & BIZMAC CLIENT WRITE-UP ARE TRADEMARKS OF APPLIED LOGIC SYSTEMS, INC.

A PRINTER SO FAST YOUR APPLE WON'T KNOW WHAT HIT IT.

If you're hunting for the perfect printer for your Apple® II, IIc, IIe or Macintosh™, there's one way you can't miss. Set your sights on the ProWriter™ 8510SAR+NLQ or 1550SAR+NLQ from C.Itoh.

Because no matter what your application, this dot matrix printer does the job faster than any other in its price class. At only \$629.

If it's data processing you need, the 8510SAR+NLQ zips out 180 cps, with 110 lines per minute throughput. You can also get memo quality at 120 cps and, as an added feature, beautifully sharp near letter quality printing as well.

For graphics work, the 8510SAR+NLQ prints a full 50% faster than others in its league.

And when it comes to reliability, the ProWriter never falls short of the mark. Because like every C.Itoh printer, the 8510SAR+NLQ has been rigorously tested and proven on the job. And it comes with a full year's warranty, backed by 350 service centers coast-to-coast.

With over a decade of experience, and the strong backing of its 126-year-old, \$60 billion parent company, it's little wonder C.Itoh printers outsell the others by a long shot.

For more information on the ProWriter 8510SAR+NLQ or the wider carriage version 1550SAR+NLQ, see your C.Itoh dealer or call toll free 1-800-423-0300.

Or write C.Itoh Digital Products, Inc., 19750 South Vermont Avenue, Suite 220, Torrance, CA 90502.

™ Macintosh is a Trademark of Apple Computer Corp.
ProWriter is a Trademark of C.Itoh Digital Products.
® Apple is a Registered Trademark of Apple Computer Corp.
© 1985 C.ITOH DIGITAL PRODUCTS, INC.

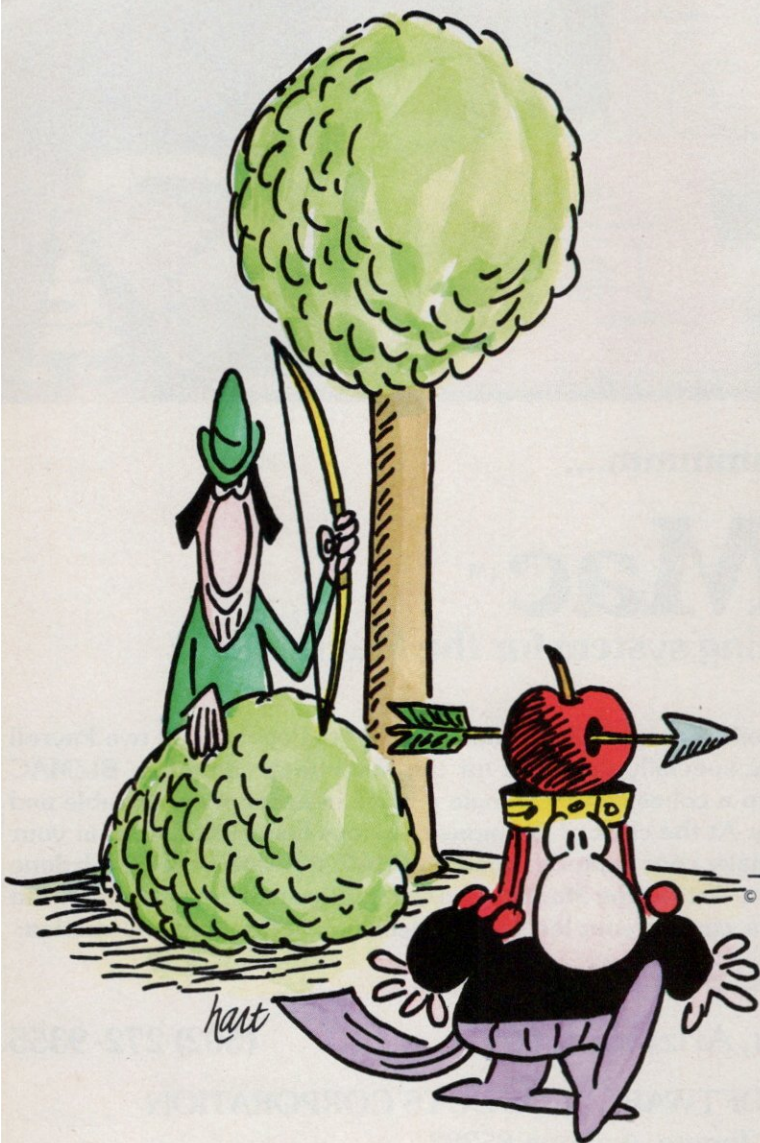

© 1984 News Group Chicago, Inc.



C.ITOH
Printers

Games,
pictures,
product demos,
and templates

PENNY-WISE

PROGRAMS

In keeping with this month's theme of summer fun with your Apple, this second, and final, part of our look at public-domain programs for the Macintosh begins with an overview of games.

Macintosh programmers have contributed excellent games to the public domain. They range from arcade-style games to strategy games to old-fashioned board games, many of which rival commercial games in visual appeal and quality of play.

Arcade-game fans have several good choices. *Missile Command* by Robert P. Munafo is an enjoyable and relatively faithful rendition of the arcade classic of the same name (see figure 1). You aim and detonate aerial bombs with the mouse, and, although the game is fairly easy at first, progressive attack waves become more and more difficult to deal with, as is the case in the original.

For former *Asteroids* addicts, and for those too young to remember it, *Megaroids* by Mike and Mitch Bunnell is an excellent substitute. Floating in a black void is the familiar triangular spaceship (looking a bit like a folded paper airplane this time), while three-dimensional boulders ca-



reen past and enemy spaceships make an occasional appearance. Sound effects are much like those of the original (or my memory of the original), and, just as in the old days, ship control and gun firing are a four-button (or key, actually), two-handed affair that requires considerable skill and practice to master effectively.

One of the first (and still one of the

most intellectually challenging) public-domain games is a combination strategy/arcade game, written by Johan Strandberg, called *Daleks*. The major objective of *Daleks* is, as with most arcade-style games, survival. This game differs from the usual arcade-style game, though, in that the action can be as slow or fast as you choose, and your major defense is a passive one: hiding behind the ash heaps of deceased enemy robots (the robots, or daleks, die primarily by colliding with other robots). Thus, in spite of the game's do-or-die appearance, its appeal is more for those of nimble minds than nimble fingers. (Caution: do not select *About Daleks* from the Apple menu—it doesn't explain how to play, and it does sometimes crash the program.)

Other public-domain games are entirely strategic. The most famous of these is *Life*, originally created by mathematician John Conway and popularized by Martin Gardner's columns in *Scientific American* in the 1970s. *Life* is a simple game with cells located on a graph-paper-like grid and three deceptively simple rules (which regulate the birth of new cells and the continued survival and death of existing cells in each generation). It

is, in fact, hardly a game at all, since it has only one player—the Mac—and hence no winners or losers, and no real end. Your only tasks are to set up the initial conditions (and you can usually skip even that step if you want, by having the program do the job for you) and then watch what happens. What makes Life fascinating, however, is its elegant and ever-changing demonstration of how exceedingly complex “universes” can arise from a small number of cells and a few simple rules. (For more information about the facts of Life and its many complexities, see *The Recursive Universe* by William Poundstone [Morrow, 1985].)

Three versions of Life for the Macintosh are now in the public domain. The first to appear was Bill Atkinson's, and although it is the simplest of the three versions, it is probably the most enjoyable. It automatically displays succeeding generations at nine different speeds. If you have an analytical bent, you can step through the generations one at a time. With Auto Restart, the program starts over with a new random pattern, once the current progression reaches a stable, unchanging state. When you select Mutations, the program randomly inserts individual cells every few seconds to insert an element of unpredictability. If you combine Auto Restart and Mutations, the Mac screen will become a lively and never-ending microcosm (see figure 2).

Another version of Life, by Larry Hutchinson, is called LAZlife. It features three generational speeds and, more interestingly, three grid sizes. In the hi-res grid, each cell is the size of a single pixel, producing what must be the largest Life grid available on a personal computer. With such a large grid, you can watch complex Life forms that simply don't fit on smaller screens (see figure 3). The lack of a FatBits mode makes the



Megaroids

precise choice of individual cells on the hi-res grid exceedingly difficult, however. A third version, by Dennis C. De Mars, has only one grid size, one speed, and no random pattern generator, and is further limited in that you can't “paint” cells onto the grid but must

turn each one on individually (with a click of the mouse). What it does do that the other versions cannot, however, is let you save and retrieve patterns of special interest—a useful feature for those with experimental inclinations. Also, De Mars has taken advantage of this feature by providing several files with some of the classic Life forms already entered and ready to roll (see figure 4).

The game of Water is modeled on a situation more like real life than Life: the struggle between predators and their prey to survive. Designed by A.K. Dewdney and described in his “Computer Recreations” column in *Scientific American* (December 1984), Water is a sophisticated ecological simulation of sharks and fish that also happens to be fun to play. The player determines the rules: the amount of time it takes fish and sharks to reproduce and how long it takes a shark that fails to find prey to die (the hapless small fish are at least given unlimited food supplies). The player also determines the initial number of sharks and fish (but not their position). Once these five conditions are determined, the program takes over, and it's shark eat fish.

Something's Fishy

Robert Martin has programmed Water for the Macintosh and made it available on CompuServe. It comprises 12 files (plus 1 for the documentation) that take about 20 minutes to download at 1200 bps. (The



Reversi

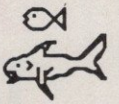

Water



Backgammon

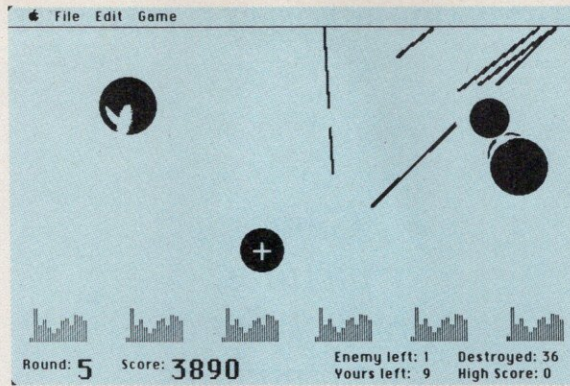

Figure 1: I may have been doing pretty well at the end of round 5 of Missile Command, but you should have seen what happened to me in round 6.

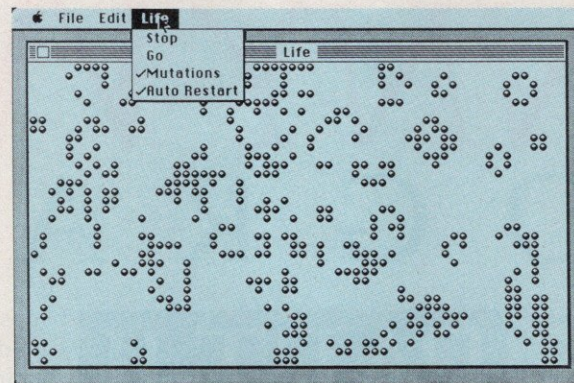

Figure 2: Bill Atkinson's game of Life has two options, Mutations and Auto Restart, which turn your Mac screen into a never-ending and ever-changing drama of life and death. This particular screen is a scene somewhere between the totally random (computer-generated) beginning and the final, somewhat stable “end.”

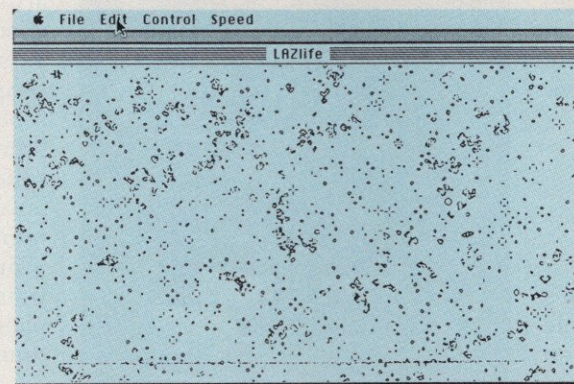
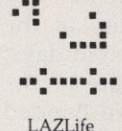

Figure 3: The hi-res screen of LAZlife is probably the largest (in terms of number of cells) on any microcomputer. This screen started as a random pattern generated by the computer. Now, after considerable evolution and a great many generations, eagle-eyed Life aficionados should be able to find many of the classic Life patterns.

LAZlife



LAZlife

reason for the large number of files is that Martin has conveniently divided his program into modules that demonstrate different aspects of programming in Aztec C—nonprogrammers, fortunately, can simply ignore this technicality. Once downloading is complete, you can simply convert the executable file WATER.HCX with Binhex, put the remaining files away

“A LIVING TAPESTRY . . .”

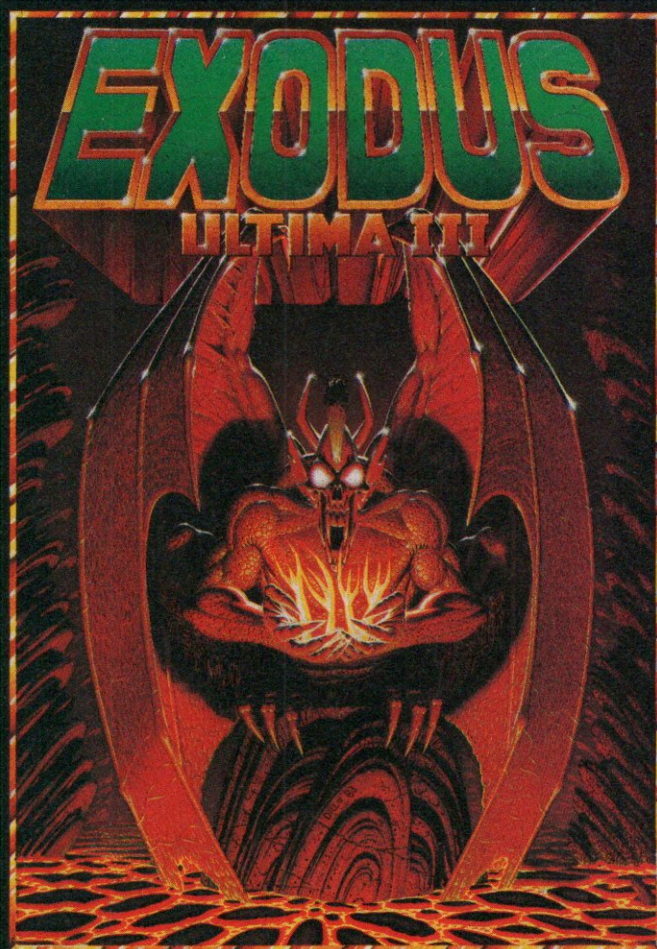

NOW
AVAILABLE ON
MACINTOSH™

“The world of *Ultima III* can only be compared to a living tapestry — complex and beautiful . . . This is the best fantasy game in computing. Indeed, it is one of the best fantasy worlds in which to live. Lord British is a veritable JRR Tolkien of the keyboard.” — Popular Mechanics

“*Exodus: Ultima III*, with a superior plot to match its superior gaming system, is a great game. It upgrades the market; in several ways it sets new standards for fantasy gaming state of the art.” — Softline

“*Exodus: Ultima III* is Lord British’s magnum opus — so far. It’s fun and exciting to play and constantly intriguing. And the ending is marvelously unexpected and not a bit disappointing — except that it is the ending, and as with a good book, you’ll probably wish there were more.” — Softalk

Available on: Apple, Atari, Com64, IBM

 **ORIGIN**
SYSTEMS INC.

1545 OSGOOD ST., #7 NORTH ANDOVER, MA 01845
(617) 681-0609

Apple, Atari, Com64, and IBM are trademarks of Apple Inc., Atari Inc., Commodore Business Machines, and IBM, respectively.
Ultima and Lord British are trademarks of Richard Garriott. Copyright 1984 by Origin Systems, Inc.

CIRCLE 145 ON READER SERVICE CARD

**Concerning
the nature of
speed and its
rightful place
within the
Macintosh.**

The Macintosh™ gave the world the notion of “radical ease of use.” But in order to do so, it had to do a great deal of extra work. A process that also consumes a great deal of time.

Then along came the external hard disk drive. Which made the Macintosh work faster, but still not fast enough for most business people.

So we thought of our own solution. HyperDrive™.

HyperDrive. It's the fastest, because it's where it belongs.

HyperDrive is the only hard disk made to go inside the Macintosh.



HyperDrive is precisely where every disk drive should be.

Which obviously means one more port free for other things, like Apple Talk™.

But more important, HyperDrive works up to 15 times faster than a floppy. And 50 to 100%

faster than external drives.

Because it hooks right onto the Macintosh circuit board.

HyperDrive. It's engineered to give the Macintosh a place in the business world.

Unlike other hard disks, HyperDrive will run any software that a regular Macintosh runs. Including Apple's® own Finder™. What's more, HyperDrive's own software will

If it runs on a Macintosh, it'll run on a HyperDrive Macintosh.

™Apple Talk, Apple, Finder and LaserWriter are registered trademarks of Apple Computer, Inc. ™Lotus and Jazz are registered trademarks of the Lotus Development Corporation. ™HyperDrive is a registered trademark of the General Computer Company. ™Macintosh is a trademark licensed to Apple Computer, Inc.

allow you to back up and restore whatever's on the hard disk to and from floppies. At a rate of one floppy in under 50 seconds.

And for really going to work with items like Apple's LaserWriter™ or Lotus™ Jazz™, you'll find you need HyperDrive. Because HyperDrive will actually make them work to their maximum, something no other disk drive can do.

HyperDrive. It will actually keep you busy.

With HyperDrive, a Lake Tahoe resort manager doubled his business in four months. Simply by being able to produce twice as many reports and mailings.

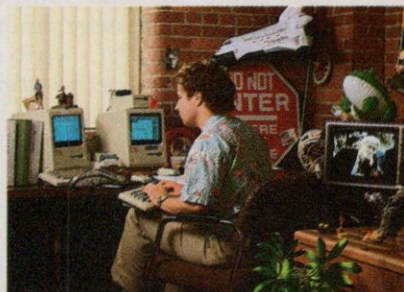

Will Donahue slip in the ratings now that there's HyperDrive?

Unfortunately, you can't please everyone.

One software developer used to watch the Phil Donahue show while waiting for his Macintosh to compile. But once he started using HyperDrive, he didn't have that free time. And as he said, “I don't know what's going on in the world anymore.”

Find out how to keep yourself busy. Call us at 1-800-422-0101. In Massachusetts (617) 492-5500.



HyperDrive

General Computer Company
215 First St., Cambridge, MA 02142

See us at Booth No. 440
at the Mac World Expo
in Boston on Aug 21-23.

CIRCLE 322 ON READER SERVICE CARD

in a folder, and double-click on the shark/fish icon of the converted file to start the program.)

Once you've established the five initial conditions, the program runs until you tell it to stop. Three windows keep you posted on what's happening: a graphic Water universe, which is toroidal (i.e., opposite edges are actually contiguous), with fish in gray and sharks in black; a population graph, showing the numbers of each species over time; and a statistics box, which gives the current population sizes as well as the elapsed time, measured in arbitrary units called chronons (see figure 5). The fun, of course, comes in determining what makes the Water ecosystem tick by experimenting with different starting conditions and watching (or betting on) what happens.

Board Games

Those who prefer to play against, rather than with, the computer, can choose from several classic board games available for the Mac. Two versions of Othello, or Reversi, are in the public domain. One, by Robert J. Woodhead, allows you to take back your last turn, save a game and reload it in midplay, and change the degree of sophistication (three levels for each of two parameters) with which the program analyzes its next move (see figure 6). The other, Iago, by David Reed, has three levels of play, three different playing-board sizes (the standard 8 squares by 8 squares, plus 10 by 10 and 12 by 12), a time clock for each player, and options that let you take back your last move or play back the entire game—this last feature is apparently for masochistic types who like to see their mistakes replayed (see figure 7).

If you enjoy Backgammon, you should take a look at the three-dimensional version for the Mac, by Stephen D. Young and Debra Willrett (see figure 8). Other programmers have created a variety of board games that run under different programming languages. For example, you'll find a fiendishly difficult facsimile of

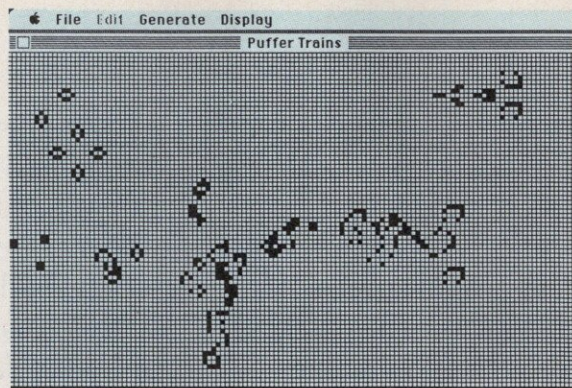

Figure 4: With Dennis de Mars' version of Life, you can make the grid visible and save and reload especially interesting Life forms. In this example, two Puffer Trains from one of de Mars' pattern files are chugging from left to right. The one on top leaves an evanescent exhaust, but the one on the bottom emits a long-lasting and constantly changing plume.

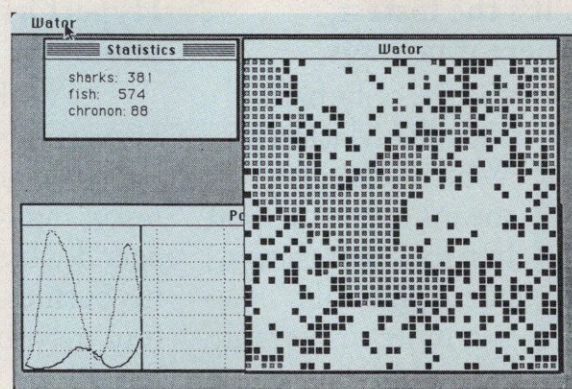

Figure 5: The game of Water is a sophisticated ecological simulation of sharks and fish. The Water Universe is to the right and its vital statistics and recent population history to the left. The fish in this example are clearly looking for a more stable relationship.

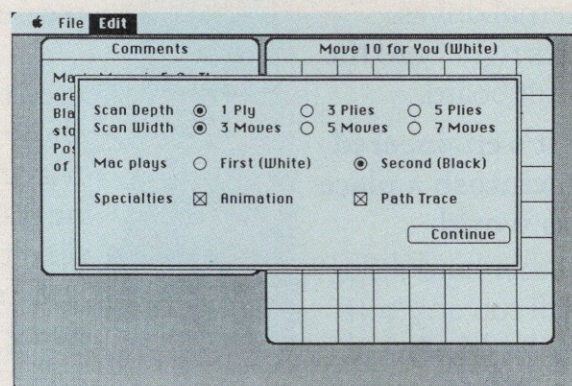

Figure 6: Woodhead's Reversi allows you to take back your last turn, or to save a game and reload it midplay. It also lets you elect the skill level of your computer opponent according to two different parameters.

Mastermind written by Shep Tamler in MS-BASIC 1.0., in addition to two versions of Go (one in MS-BASIC by George Acton, the other in MacForth by Bruce F. Webster) and a MacForth Roulette by Bob Fusco.

Ready-made Pictures

If you find drawing with the



Iago

mouse difficult, you'll be happy to know that the public domain is replete with other people's masterpieces. You can find a few examples of MacPaint pictures in the disk libraries of users' groups, but the greatest volume of electronic art is available on local bulletin-board services and on CompuServe. Renditions of insects and dinosaurs, Mickey Mouse and R2D2, Steve Jobs and (for some reason) an IBM PC are some examples. Just as in any art gallery, the quality of the work varies considerably, so be careful (and conservative) in your collecting.

Other, more productive, types of MacPaint files are those that help you with your own artwork. For example, you can get pattern collections by Gerald Blalock on three MacPaint documents, each containing 144 different patterns you can insert into your own MacPaint files by copying them with the Edit Pattern dialog box. For music-cassette collectors, Dave Eilers' cassette-label template takes the pain out of creating professional-looking labels that you can sandwich between the box and the existing cardboard insert. All you need to do is fill in the appropriate title and composer information with the text tool in MacPaint, print, cut and fold along the lines, and your cassettes will never have looked so good. Similarly, Bart Thomas and Paul Dobbs have created generic disk labels (for such things as utilities, MacWrite files, BASIC programs, MacPaint documents, and the like), with appropriate graphics on the front and titles on the spine and back. Just print them, cut them out, and paste them onto the disk.

Useful in quite a different way are pictures created by some of the new digitizers on the market. Often the subject matter does not lend itself to a great variety of uses (the picture of pop singer Madonna has limited potential, for example), but by downloading several images produced by different digitizers, you can get an idea of the differences between them.

No matter which computer you use...

WE COVER ALL SYSTEMS AND THEIR NEEDS.

Every month CREATIVE COMPUTING brings you the information you need to expand the functions of your system—any system—without any bias.

CREATIVE COMPUTING goes beyond machine specific magazines, providing you with a vital exchange of ideas and insights from all the world's leading computer manufacturers, as well as the technological innovators entering the marketplace.

Whether you're expanding your system with new hardware, software, or add-ons, you need all the information available—and we deliver just that!

If you're upgrading with memory boards, CREATIVE COMPUTING will help you choose the ones that meet your needs *and* budget!

When you're using word processors, we provide you with

thorough reviews on software and new innovations—with hands-on tips you can apply!

And if you need more information on color monitors or printers, you can depend on CREATIVE COMPUTING for a complete comparison—for all systems!

No matter which computer you use — Apple, IBM, Atari, TRS-80, or any other system—we can tell you what's new and available for you to expand your system —any system!

Stay in the know and make the most out of your computer!
—Get CREATIVE COMPUTING with savings up to 50%!

- 9 issues for only \$99.7!
SAVE 47%!
- 12 issues for only \$12.97!
SAVE 48%!
- 24 issues for only \$24.97!
SAVE 50%!

For faster service call toll free,
1-800-852-5200



(On CompuServe, use the Key option of the Browse command in MAUG's Data Library 6 to find images created with a specific brand of digitizer.) Armed with this information, you can go out and buy the digitizer that creates images in the style and quality you prefer.

Similarly, many commercial Mac-clip-art manufacturers have discovered that examples of their wares placed in users'-group libraries and on BBSs are a useful, as well as informative, form of advertising. An example is a file from Cut 'n' Paste (made by Dreams of the Phoenix) that contains, among other images, a highly detailed old-fashioned steam engine.

Clip-art makers are not the only ones who have discovered the effectiveness of what amounts to free samples. Other companies have placed "crippled" versions of their products in the public domain for prospective customers to try out. One of the most fully featured of these is the MacMusic demo by Utopian Software. It contains all the features of the release version, except

that you cannot save any of the music you create. The demo includes several previously transcribed and saved pieces (from the Beatles to Johann Strauss and John Philip Sousa) and a special music font that you have to

croassembler. Even if you don't know (or care) what that means, this small stand-alone program is quite impressive and fun to play with. A stick-figure drawing of the Mac tumbles through space in one of the screen's windows (see figure 9). You can alter the speed and direction of its sometimes dizzying gyrations by holding down the x, y, or z keys while simultaneously pressing + or - (to increase or decrease the rotation in each of the three axes).

Similarly, First Byte has created a sophisticated and self-running demonstration of its Smoothtalker speech-synthesis program and placed it in the public domain (as well as with its dealers). Although it lacks the excitement that comes with a hands-on-style demo program, it gives an excellent idea of what the program can do and is amusing and rather eye-catching as well.

Templates for Favorite Programs

If you've ever stared at a blank Filevision (or Multiplan or what-have-you) screen and wished that someone else would do the initial set-

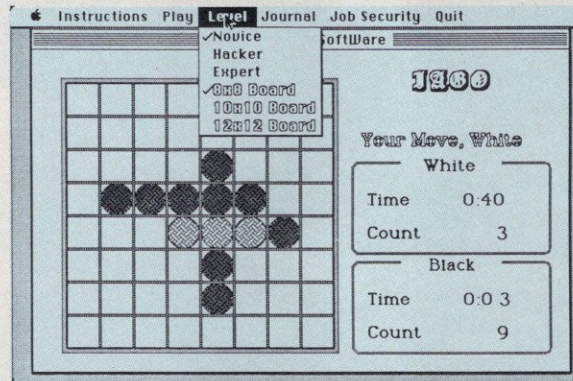

Figure 7: Iago has three skill levels, three board sizes, and a clock that always seems to cheat (from the human perspective, at any rate) in favor of the computer.

install (in the System file) with the Font Mover to use the program.

A demo that is as entertaining as it is informative is the Tumbling Mac program by Yves Lempereur. Its primary purpose is to illustrate the kind of sophisticated assembly-language programming that is possible with the Mainstay MacASM editor/ma-

Take the Challenge!



mac **CHALLENGER™**

Space Shuttle Flight Simulation for the **MACINTOSH™**

NOW SHIPPING!



AEGIS DEVELOPMENT, INC.
2210 Wilshire Blvd., Suite 277
Santa Monica, CA 90403

DEALER INQUIRIES INVITED
213/306-0735

Macintosh is a trademark of Apple Computer
Mac-Challenger is a trademark of Aegis Development, Inc.

CIRCLE 317 ON READER SERVICE CARD

up work for you, then you'll be glad to know that many templates for popular commercial programs are in the public domain.

The number of templates for business programs such as Multiplan are fairly limited: a home-budget template, a payroll template for a small business, a three-part template for calculating 1984 taxes that you can use as a model for creating a template for next year, and a few others. For more-stimulating and more-Macintosh-specific programs, however, a sizable library of public-domain templates has accumulated.

Filevision templates are not very common on CompuServe or other electronic bulletin boards, but you can find them in some abundance on disks from various sources. One such source is users' groups. Berkeley MUG, for example, distributes a disk devoted entirely to Filevision templates, including a periodic table of the elements.

It is no surprise, however, that the best source for Filevision templates is Telos Software itself. In return for a

blank disk (or disks) and a self-addressed, stamped envelope, Telos will send you up to three disks of Filevision templates. They include everything from traditional filing exercises (using folders and file cabinets as the visual elements) to maps (sites for the

ber of templates in the public domain is MusicWorks. Indeed, for a while after its introduction, every other program on CompuServe seemed to be a MusicWorks score. Some are of dubious artistic merit (such as "Louie, Louie," transcribed by Todd Nix);

others are well worth the cost of downloading (such as Bach's "Jesu, Joy of Man's Desiring," transcribed by Price Collins). One score in particular is notable for the quality of the music and the magnitude of the effort: Richard Rae's transcription of selections from Praetorius' *Ballet de la Royme*. Each selection is a separate file, because of MusicWork's file-size limitations, but with another public-domain program, Jukebox, by Jay Fenton (which can play as many as 32 MusicWorks files

in sequence), you can string pieces together into an almost seamless performance. Rae, incidentally, has transcribed quite a lot of Renaissance music for MusicWorks and has several disks available by mail.

In the time it took to convert this article from manuscript to the pages

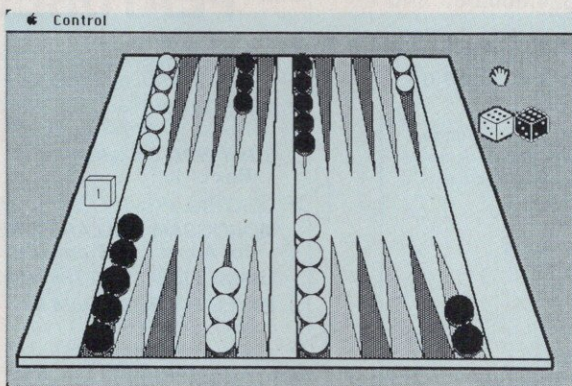
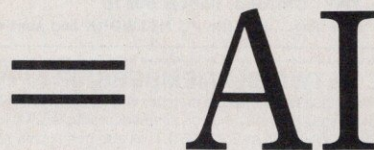
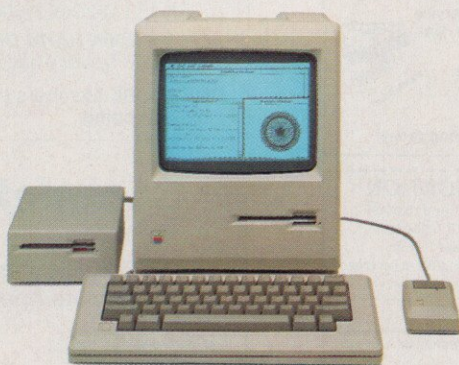
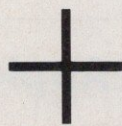

Figure 8: Backgammon has a three-dimensional board and uses a grabberlike hand to roll the dice and move the pieces.

1984 Summer Olympics, the organization of the piano keyboard) to tree-structured relationships (family trees, corporate organization charts) to animated sequences and an adventure game that are simply for fun (see figure 10).

The all-time champ for the num-



ExperTelligence™ has the "tools" to transform your Macintosh™ into a powerful Artificial Intelligence workstation. **ExperLisp™** is the first complete implementation of LISP on a microcomputer. Developed on a Symbolics 3600,™ the compiler generates efficient MC68000 code providing speed and function ideal for the development and delivery of sophisticated AI applications. **ExperOPS5™**, by Science Applications International Corporation, is a complete implementation of the well-known OPS5 expert systems building tool. It provides a fast and efficient method for constructing complex Expert Systems.

ExperLogo™ features 3-D and spherical graphics, English-like commands and shares the speed and function of ExperLisp. In the classroom or in the lab, ExperLogo provides an environment for discovery and exploration for children and developers alike.

Call today for more information about these and other innovative AI products.



ExperTelligence, Inc.
559 San Ysidro Road
Santa Barbara, CA 93108
Tel: 805/969-7871.

Macintosh is a trademark licensed to Apple Computer, Inc.
Symbolics 3600 is a registered trademark of Symbolics, Inc.

BUY HARDWARE AND SOFTWARE AT WHOLESALE + 8% AND GET 14-30 DAY SOFTWARE RENTALS†..

In just the last few months, *The NETWORK* has saved its members more than \$24,000,000 and processed over 100,000 orders.

The nation's largest corporations depend on PC NETWORK!

On our corporate roster are some of the nation's largest financial industrial and professional concerns *including some of the most important names in the computer industry:*

AT&T	General Motors
Barclays Bank	Gillette
Bell & Howell	Hewlett Packard
Citibank	Hughes Aircraft
Columbia University	IBM
Data General	ITT
Exxon	Kodak
Farm Bureau Insurance	Multimate
Frontier Airlines	United Nations
General Mills	Yale University
General Electric	Veteran's Administration

plus thousands of satisfied consulting firms, small businesses, user groups, municipalities, government agencies and value-wise individuals ACROSS THE NATION! Their buyers know that purchasing or renting from PC NETWORK saves them time, money and trouble. They also count on us for product evaluation, professional consultation and the broadest spectrum of products and brands around.

CALL TOLL FREE 1-800-621-S-A-V-E

In Illinois call (312) 280-0002

Your Membership Validation Number: M585

You can validate your membership number and, if you wish, place your first money-saving order over the phone by using your VISA, MASTERCARD or AMERICAN EXPRESS. Our knowledgeable service consultants are on duty Mon-Fri 8 AM to 7 PM, SAT 9 AM to 5 PM CST.

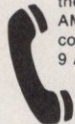

PERSONAL COMPUTER NETWORK
320 West Ohio
Chicago, Illinois 60610



Call now... Join the PC NETWORK and start saving today!

PC NETWORK • MEMBERSHIP APPLICATION

YES! Please enroll me as a member in the PC NETWORK™ and rush my catalog featuring thousands of computer products, all at just 8% above DEALER WHOLESALE PRICES. I will also periodically receive "THE PRINTOUT", a special up-date on merchandise at prices BELOW even those in my wholesale catalog, and all the other exclusive, money-saving services available to Members.

585

I am under no obligation to buy anything. My complete satisfaction is guaranteed. Please check (✓) all boxes that apply:

- | | |
|---|--|
| Basic Membership
With 14 Days Rental | Special V.I.P. Membership*
With 30 Days Rental. |
| <input type="checkbox"/> One-year membership for \$8 | <input type="checkbox"/> One-year membership for \$15 |
| <input type="checkbox"/> Two-year membership for \$15 (SAVE \$1) | <input type="checkbox"/> Two-year membership for \$25 (SAVE \$5) |
| <input type="checkbox"/> Business Software Rental Library for \$25 add'l. per year—with 14 day rentals | <input type="checkbox"/> BOTH Business and Game Software Rental Libraries for \$30 add'l. per year—with 30 day rentals |
| <input type="checkbox"/> Games Software Rental Library for \$10 add'l. per year | *VIP members receive advance notice on limited quantity merchandise specials |
| <input type="checkbox"/> Bill my credit card: <input type="checkbox"/> VISA <input type="checkbox"/> MasterCard <input type="checkbox"/> American Express | |

Account Number:

Exp. Date _____

mo. year

Check or money order enclosed for \$ _____

Name _____

Address _____ Apt. No. _____

City _____ State _____ Zip _____

Telephone () _____

Please provide the following information to insure compatibility with your system (check all boxes that apply):

- | | | | |
|---------------------------------------|------------------------------------|------------------------------------|---------------------------------|
| <input type="checkbox"/> APPLE //e | <input type="checkbox"/> APPLE //c | <input type="checkbox"/> APPLE //+ | <input type="checkbox"/> IBM-AT |
| <input type="checkbox"/> MACINTOSH | <input type="checkbox"/> LISA | <input type="checkbox"/> APPLE III | <input type="checkbox"/> IBM PC |
| <input type="checkbox"/> Other: _____ | | | |

Signature _____
(Signature required to validate membership)

Copyright © 1985, PC NETWORK INC.

FEATURED PRODUCTS

- ▶ **BRAND NAME SSDD DISKETTES FOR APPLE II and III**
Box of 10 Guaranteed for Life \$9.00*
- ▶ **BRAND NAME MACINTOSH DISKETTES**
Box of 10 Guaranteed for Life. Includes free Flip & File Case 24.95*
- ▶ **SONY MAC Diskettes**
Box of 10 24.50*
- ▶ **CENTRAL POINT COPY II + COPY II-MAC** 20.00*
- ▶ **MONOGRAM DOLLARS & SENSE**
for Apple II + /E and Mac 57.00*
- ▶ **LIVING VIDEOTEXT Think-Tank + /E/MAC** 75.00*
- ▶ **HAYES MICROMODEM IIe**
With Smartcom I 125.00*
- ▶ **HAYDEN ENSEMBLE** 155.00*
1st integrated package for the MAC
- ▶ **HABA 800KB MAC ADD ON DRIVE**
Twice the Capacity! Reads Standard Disks! 315.00*
- ▶ **HABA QUARTET INTEGRATED SOFTWARE**
Jazz Features Available Now! Runs on 128K MAC 101.95*
- ▶ **MICROSOFT AT UNHEARD OF PRICES!**
Multiplan, File or Word 102.00*
BASIC 79.00*
Chart 66.00*
- ▶ **APPLE WIDE IMAGEWRITER**
with Macintosh Accessory Kit 485.00*
- ▶ **1st Byte Smooth Talker**
Voice Synthesis for the MAC 70.00*
- ▶ **MICROCOM MAC Modem**
A Complete Communication System 365.00*
- ▶ **EPSON PRINTERS Unbelievable Low Prices!!!**
LX-80 80COL/100CPS 205.00*
FX-80 80COL/160CPS 303.00*
FX-100 132COL/160CPS 434.00*
- ▶ **IBM PC 256K HARD DISK SYSTEM** 1,886.62*
1-320K Drive/1-10MB Hard Disk/256KCPU

*NETWORK Members pay just 8% above these wholesale prices plus shipping.

Complete Apple Systems

The NETWORK offers fantastic discounts on these three complete Apple packages.

- ▶ **APPLE //c**
128K System
Modem Port
Serial Printer Port
Mouse/Game Port
Composite/RGB/TV
40/80 Column
Monitor Port
QWERTY/DVORAK
Keyboard
Built in Drive
Software

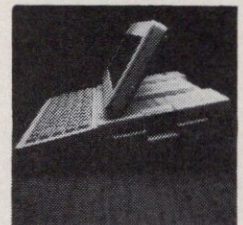

TOO LOW TO PRINT!

- ▶ **MACINTOSH BASE SYSTEM**
128K Memory
400K Diskette
Keyboard
Mouse
Software



TOO LOW TO PRINT!

Wholesale Prices Change Rapidly... if you ever see a lower price advertised anywhere please call! You will find the Network's Price will always be the best!

...AS A PC NETWORK MEMBER ONLY!

Listed below are just a few of the over 20,000 products available at our EVERYDAY LOW PRICES!

GAMES & EDUCATIONAL SOFTWARE

(Please add \$1 shipping and handling for each title ordered from below.)

	Wholesale		Wholesale
Bluechip <i>Batman, Milkandore or Tycoon</i>	\$ 28.25*	Infocom <i>Zork I: Witness</i>	\$ 20.50*
Broderbund <i>Loadrunner</i>	19.75*	Infocom <i>Suspect, Intide, Sorcerer</i>	25.00*
Broderbund <i>Chopflifer</i>	19.00*	Infocom <i>Hitchhiker's Guide, Sealstaker</i>	22.00*
Broderbund <i>Print Shop</i>	28.75*	Penquin <i>Graphics: Magician—Mac Only</i>	28.97*
CBS <i>Goren-Bridge Made Easy</i>	45.00*	Penquin <i>Transylvania Macintosh Version Only</i>	20.97*
CBS <i>Mastering the SAT</i>	81.00*	Screenplay <i>Professional Blackjack</i>	39.88*
CBS <i>Murder By The Dozen</i>	20.97*	Sierra <i>On-Line Frogger Mac Too!</i>	21.00*
Davidson & Associates <i>Speed Reader II</i>	37.97*	Sierra <i>On-Line Crossfire</i>	18.00*
Davidson & Associates <i>Math Blaster</i>	29.97*	Simon & Schuster <i>Typing Tutor III—Mac Too!</i>	28.25*
Davidson & Associates <i>Word Attack</i>	29.97*	Sir-Tech <i>Wizardry</i>	28.50*
Epyx <i>Temple of Apsah</i>	21.97*	Sublogic <i>Night Mission Pinball</i>	20.00*
Hayden <i>DaVinci—Houses/Interiors or Landscapes—</i>	29.97*	Spinnaker <i>Alphabet Zoo, Face Maker, Kinder Comp, Hey, Diddle Diddle, Rhymes & Riddles, Story Machine</i>	15.97*
Hayden <i>Sargon III</i>	28.47*	Spinnaker <i>Delta Drawing</i>	24.97*
Hayden-SAT <i>Sampler Test</i>	11.97*	Spinnaker <i>The Most Amazing Thing</i>	20.77*
Infocom <i>Deadline, Suspended</i>	28.00*	Vide Mac <i>Gammon & Cribbage—Mac Only</i>	25.17*
Infocom <i>Enchanter, Planet Fall, Cutthroats</i>	20.50*	Vide Mac <i>Vegas—Mac Only</i>	31.00*
Infocom <i>Zork II, Zork III</i>	23.50*	Virtual <i>Combinatics Micro Cookbook</i>	21.00*

BUSINESS SOFTWARE

(Please add \$2.50 shipping and handling for each title ordered from below.)

Assimilation Process <i>Mac/Tracks or Lock-It</i>	\$ 19.25*	Microsoft <i>File for Macintosh</i>	\$102.25*
ATI <i>How to use Multiplan</i>	42.00*	Microsoft <i>Multiplan for Macintosh</i>	102.25*
Borland <i>International Turbo Pascal</i>	30.00*	Microsoft <i>Basic for Macintosh</i>	85.00*
BPI <i>GL, AR, AR, PR, or HW Each Only</i>	211.50*	Microsoft <i>Chart for Macintosh</i>	86.25*
Broderbund <i>Bank Street Writer</i>	40.00*	Microsoft <i>Draw for Macintosh</i>	105.00*
Central Point <i>Copy II Plus</i>	20.00*	Monogram <i>Dollars & Sense</i>	52.00*
Down Jones Software <i>Market Analyzer</i>	198.00*	Monogram <i>Dollars & Sense for Macintosh Version Only</i>	89.98*
Down Jones Software <i>Market Manager</i>	103.50*	Odesta <i>Hexix for Macintosh Reg's 512K</i>	237.00*
Frank Software <i>3-D</i>	35.00*	Sensible Software <i>Sensible Speller IV</i>	87.50*
Human Edge <i>Mind Prober</i>	26.50*	Softcraft <i>Fancy Fonts</i>	125.00*
Human Edge <i>Management of Sales Edge</i>	110.00*	Software Publishing <i>PFS: File</i>	68.00*
Human Edge <i>Communication Edge</i>	98.00*	Software Publishing <i>PFS: Write</i>	68.00*
Living <i>Videotext! Think (Tune Mac Too!)</i>	75.00*	Software Publishing <i>PFS: Graph</i>	69.00*
Mark of the Unicorn <i>Mouse Stampede</i>	23.97*	PC Network <i>280 Card</i>	115.00*
Microsoft <i>Wordplan (DOS or CP/M)</i>	105.00*	T.Maker <i>Click Art for Macintosh Version Only</i>	29.97*
Microsoft <i>Multiplan for Macintosh</i>	102.25*	United Software <i>Ind. Ascii Express Pro</i>	71.50*

HARDWARE

(Please add shipping and handling charges found in italics next to price.)

COMPLETE SYSTEMS		BOARDS AND BUFFERS	
Apple <i>Macintosh Base System</i>	CALL	ALS <i>Z-Engine</i>	\$ 129.00* (2/50)
Apple <i>Apple IIc</i>	CALL	AST <i>Research Multi I/O-2 Serial/Clock</i>	165.00* (2/50)
Columbia <i>Desktop & Portable Systems</i>	CALL	AST <i>Premium Software Card</i>	243.57* (2/50)
Compaq <i>Desk Pro System with Tape Backup with 640K/1 Floppy/10MB Hard Disk/10MB Tape Drive/Monitor</i>	\$3,018.14* (65/20)	Microtek <i>Dumping GX</i>	55.00* (2/50)
Compaq <i>486/33 Mhz Pentade</i>	\$2,285.00* (49/35)	Microtek <i>Magnum 80me 80 cool - 64K</i>	93.00* (2/50)
DATA <i>General DG One</i>	1,999.00* (43/20)	Orange <i>Micro Grappler +</i>	96.90* (2/50)
IBM <i>PC Base System 2325D/PC/256K</i>	1,485.02* (32/35)	Orange <i>Micro Serial Grappler +</i>	78.00* (2/50)
IBM <i>PC Professional Hard Disk</i>	1,886.82* (40/75)	PC Network <i>280 Card</i>	35.00* (2/50)
IBM <i>PC AT All Configs</i>	CALL	Quadram <i>Quadram-Parallel/Serial/Clock Expandable to 256K</i>	140.00* (2/50)
Sayno <i>MBC 550 "Lowest Cost Compatible"</i>	620.00* (13/39)	Quadram <i>MP-8K Microfazer Buffer (expandable)</i>	110.00* (2/50)
Sayno <i>MBC 775 Color Portable IBM Clone</i>	1,775.00* (33/00)	Quadram <i>APIC-3 Graphics Interface</i>	52.00* (2/50)
Tava <i>PC Complete IBM Compatible (256K/2 Drives)</i>	1,200.00* (25/92)	Quadram <i>eRAM-80/80-Cal with 64 Memory</i>	88.00* (2/50)
Texas Instruments <i>Professional</i>	CALL	Street Electronics <i>ECHO II Speech Synthesizer</i>	100.00* (2/50)
		Thunderware <i>Thunderclock</i>	104.00* (2/50)

PRINTERS

Apple <i>15" Imagewriter</i>	\$ 530.00* (11/45)
Apple <i>8.5" Imagewriter</i>	446.00* (9/34)
Epson <i>LX-80/100CPS 80 COL/LQ Mode—New Model!</i>	205.00* (14/43)
Epson <i>PX-80/160CPS 80 COL</i>	303.00* (6/54)
Epson <i>FX-100/160CPS Wide Format</i>	434.00* (9/37)
Epson <i>LQ1500 NEW LQ DP Printer</i>	CALL
Epson <i>Apple-to-EPSON Parallel Cable</i>	21.00* (1/00)
NEC <i>2030/20CPS Letter Quality Printer</i>	605.00* (13/00)
NEC <i>3530/33CPS Letter Quality Printer</i>	960.00* (20/74)
Okidata <i>82A Serial & Parallel</i>	280.00* (7/00)
Okidata <i>ML 192 New 120CPS/LQ Mode/FRICT</i>	200.00* (14/34)
Okidata <i>NEW! Color 20/80CPS/100+ Colors</i>	109.00* (1/54)
Okidata <i>NEW! Epson Graphics + Mode (Requires Interface)</i>	69.00* (1/50)
Okidata <i>NEW! Epson Interface for Gamma Color 20</i>	69.00* (1/50)
Okidata <i>ML 192 New Sleek Design/160CPS/LQ Mode/FRICT/IBM Graphics</i>	340.00* (7/35)
Okidata <i>Apple-to-Okidata Parallel Cable</i>	20.75* (1/00)
Quadram <i>Quadram Multicolor Ink-Jet with Kit</i>	396.00* (8/55)
Qume <i>Sprint 1145 45 CPS Letter Quality</i>	1,155.00* (24/40)
Qume <i>IBM Cable and Interface (required)</i>	72.00* (1/00)
Silver Reed <i>EXP-500/18CPS Letter Quality</i>	280.00* (6/05)
Talley <i>MF-160L/160CPS DP/LQ Printer</i>	540.00* (12/00)
Texas Instruments <i>855 DP/LQ w/Tractor</i>	675.00* (14/70)
Toshiba <i>P-1340 80 Col version of P-1351</i>	530.00* (11/50)

ACCESSORIES AND SUPPLIES

Assimilation Process <i>Mac+Turbo+Touch</i>	\$ 79.00* (2/50)
Brand Name <i>Macintosh Diskettes</i>	24.95* (1/00)
Box of 10 <i>Guaranteed for Life</i>	
Includes free <i>File & File Case</i>	
Chalkboard <i>Powered</i>	62.00* (1/50)
Hayes <i>Mach II Joystick for file</i>	25.00* (1/50)
Hayes <i>Mach III Joystick w/Fire Button for file</i>	31.00* (1/50)
Kensington <i>Microwave System Server Fan</i>	56.97* (1/50)
Kostal <i>Kosalfax Touch Tablet</i>	78.00* (1/50)
M & R <i>Sup-R-Mod RF Modulator</i>	44.00* (1/50)
Apple <i>Macintosh Carrying Case</i>	74.00* (1/60)
Micron <i>Micro Eye</i>	275.00* (5/94)
PC Network <i>SSDD Diskettes (Box of 10)</i>	9.00* (1/00)
PC Network <i>Cooling Fan with Surge Protector & Dual Outlets</i>	25.00* (2/50)
Thunderware <i>ThunderScan Optical Digitizer</i>	155.00* (2/50)
No Expensive <i>Camera Equipment Needed!!</i>	
WP <i>Printer Paper 2600 Sheets Microline Parts</i>	17.00* (1/00)

*PC Network Members pay just 8% above the wholesale price, plus shipping. All prices reflect a 3% cash discount. Wholesale prices fluctuate rapidly—all prices in this issue have been prepared 60 days in advance. Please call for latest prices. Minimum shipping \$2.50 per order. International orders call for shipping & handling charges. Personal checks please allow 10 working days to clear.

...WITH THESE 15 UNIQUE BENEFITS

1 COST + 8% PRICING—The NETWORK purchases millions of dollars in merchandise each month. You benefit in receiving the lowest price available and all at just 8% above published dealer wholesale price.

2 OUR 600 PAGE WHOLESALE CATALOG—Members receive our 600 page wholesale catalog containing over 20,000 hardware and software products for the IBM PC, APPLE and over 50 other popular computer systems. THE NETWORK'S CATALOG IS THE LARGEST SINGLE COMPILATION OF PERSONAL COMPUTER PRODUCTS AVAILABLE TODAY. NOW UPDATED QUARTERLY!

3 IN-STOCK INSURED FAST HOME DELIVERY—The NETWORK maintains a giant multi-million dollar inventory of most popular products, allowing us to ship many orders from stock. Non-stock items are typically maintained in local warehouses just days away from The NETWORK and YOU. We pay all insurance expenses on your shipment. EMERGENCY OVERNIGHT SERVICE IS AVAILABLE ON REQUEST.

4 10 DAY RETURN POLICY—If you are not satisfied, for any reason with any hardware component purchased from The NETWORK within 10 days of receipt, we will refund your entire purchase (less shipping) with no questions asked.

5 MEMBERSHIP SATISFACTION GUARANTEE—If for any reason you are not satisfied with your membership within 30 days, we will refund your dues IN FULL.

6 EXPERIENCED CONSULTANTS—The NETWORK hires consultants, not order takers, to aid you in product selection. Our consulting staff possesses in excess of 150 man years of personal computer product experience. We back our consultants with our money back guarantee: IF ANY PRODUCT RECOMMENDED BY OUR CONSULTING STAFF FAILS TO PERFORM AS PROMISED—WE WILL TAKE IT BACK AT OUR EXPENSE FOR A 100% REFUND.

7 FREE TECHNICAL SUPPORT—The NETWORK supports every product it sells. Our qualified TECH-SUPPORT staff will help you assemble your system, interpret vendor documentation and get your software and hardware to work. WE WILL GIVE YOU ALL THE HELP YOU NEED, WHEN YOU NEED IT—FREE!

8 OPTIONAL BUSINESS RENTAL LIBRARY—All members can join our BUSINESS RENTAL LIBRARY featuring over 1000 available titles for just \$25 PER YEAR above the base membership fee. This entitles you to rent business software AT JUST 20% OF THE DISCOUNT PRICE FOR A 14 DAY PERIOD. If you decide to keep the software, the entire rental fee is deducted from the purchase price. VIP MEMBERS GET A FULL 30 DAYS for just \$30 above the V.I.P. base fee. This also includes the game library privileges for a \$5 combination savings.

9 OPTIONAL GAME SOFTWARE RENTAL LIBRARY—The Game Rental library is available to members for just \$10 PER YEAR and permits evaluation (or just enjoyment) of any game or educational software product as above.

10 SPECIAL SAVINGS BULLETINS—THE PRINTOUT—Issued Quarterly at no charge to Network members only! The Printout contains all the New Product listings and price changes you need to keep your Catalog up to date. Also, we buy excess dealer inventories, and store bankruptcy closeouts, which we turn around and make available to our members at fantastic savings via THE PRINTOUT.

11 DISCOUNT BOOK LIBRARY—Working with numerous publishers and distributors, The NETWORK has assembled a library of over 1000 computer related books and manuals at savings of up to 75% from the normal store price.

12 MEMBERSHIP REFERRAL BONUS—Our most valuable source of new members is you! To date almost 40% of our members have been referred by word of mouth from other satisfied members. For those of you who refer new members, The NETWORK will credit a cash bonus to your account applicable to any future purchase.

13 CORPORATE ACCOUNT PROGRAM—Almost 50% of The NETWORK's members are corporate buyers and users (see opposite page left). The NETWORK can establish open account status and assign designated account managers to expedite orders, and coordinate multiple location shipments.

14 QUANTITY DISCOUNTS—For large corporations, clubs, and repeat or quantity buyers The NETWORK can extend additional single order discounts, when available to us from our manufacturers and distributors.

15 PRICE PROTECTION—The PC Industry is crazy!! Prices change not yearly or monthly or even weekly but often day by day! These changes are sometimes up but are mostly down!!! THE NETWORK GUARANTEES THAT IN THE EVENT OF A PRODUCT PRICE REDUCTION, BETWEEN THE TIME YOU PLACE YOUR ORDER AND THE TIME THE PRODUCT SHIPS YOU WILL ONLY PAY THE LOWER AMOUNT!!

CALL TOLL FREE 1-800-621-S-A-V-E (orders and membership only)
In Illinois call (312) 280-0002 validation M585

in your hands, dozens of new public-domain programs have become available. The cardinal rule of public-domain software is that there will always be more. Not all of it will be worth your while, of course, but if you are careful and discriminating in your explorations of the public domain, you are bound to turn up new and useful software constantly.

I need hardly add that although many people call this stuff "free software," if you download these programs from CompuServe or from an

electronic bulletin board that requires a toll call, your bills for that on-line time will easily get out of hand. So no matter what transmission rate you're using, keep one eye on the clock (and one hand on your wallet) and learn to calculate download time—before you start the download—from the file size, which usually comes with the other file information.

Above all, don't forget the one thing that makes public-domain software so special—it always has a free trial period. If you are careful about

the costs of acquisition, trying out a public-domain program should cost you next to nothing. If it does the job you need done, then you've saved yourself some money. If it doesn't, at least you'll have the satisfaction of knowing that you didn't spend more money than you had to. **+**

Robert Eckhardt recently resigned as vice president of Simon & Schuster's Electronic Publishing Group to devote more time to reading, writing, and being outdoors.

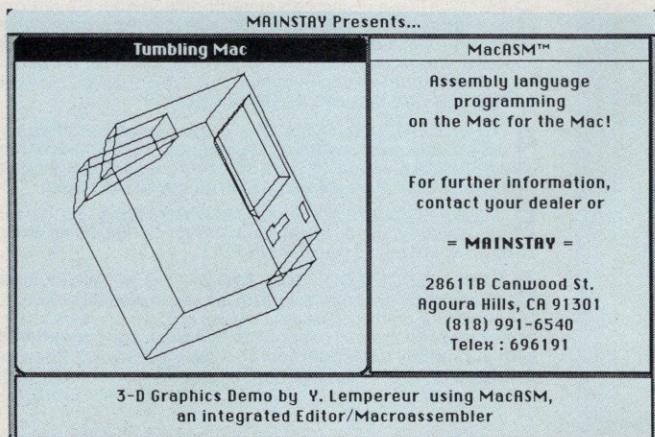

Figure 9: The Tumbling Mac demo is a sophisticated demonstration of three-dimensional Macintosh graphics.

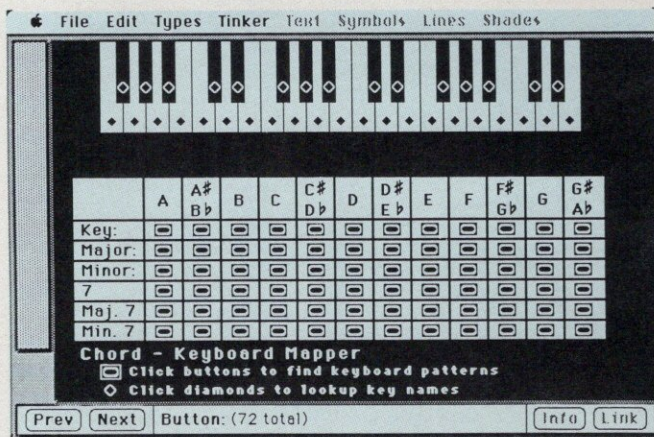

Figure 10: One of the many Filevision templates you can get from Telos Software is this piano-keyboard map.

At last... **TMON**, a genuine **debugger** with **POWER** for the **Macintosh™** from **TMQ Software, Inc.**

Features:

- Runs on 128K or 512K single Macintosh™
- Uses mouse or keyboard
- Multiple windows
- Identifies objects on the heap
- 8 types of windows:
 - Dump • Disassembly • Breakpoint • Number Conversion
 - User Function • Register • Heap • Resource File
- Recognizes symbols generated by Lisa, Pascal
 - Mouse "antifreeze"
 - Resides in low or high memory
- Heap scramble 8 times faster than Apples
- Available alternate register set
- Advanced users can generate their own functions

TMON © 1985 TMQ Software, Inc.
1110 Lake Cook Road Suite 375
Buffalo Grove, IL 60090
312-520-4440

on sale now for \$100, MasterCard and Visa accepted
\$3.00 additional for C.O.D. shipments

CIRCLE 169 ON READER SERVICE CARD

STOP PAYING THE PRICE OF BAD RIBBONS.

Buy an ordinary ribbon and you'll get what you paid for. Even worse, you'll end up paying for it again when it skips, tangles and finally jams. Especially when you're printing graphics.

Now there's a better way. The finest, premium quality ribbons can now be yours for even less than the price of ordinary ones. Constructed from precision European parts and assembled in America to the most exacting specifications.

With a rubber drive system for a more consistent pull and smoother ink flow in black plus seven other colors. And each ribbon is a generous fourteen yards instead of the usual nine. All fully guaranteed.

For the Imagewriter™ or other popular printers, you simply can't buy a better ribbon for the price.

MOUSTRAK/DITECH WEST™
A subsidiary of Moustrak, Inc. St. Helena, Calif.

To order, call: (707) 963-8179

Retail price: \$6.95...Black \$7.95...Color
\$9.95...Color heat transfer

Dealer discounts apply. On orders of 18 or more, your choice of 1 free color ribbon.

Imagewriter is a registered trademark

CIRCLE 339 ON READER SERVICE CARD

PUBLIC-DOMAIN SOFTWARE

A SELECTED LIST

Missile Command

- MAUG's DL4 (MISSLE.HCX)
- Club Mac BBS (MISSLE.APL)

Megaroids

- MAUG's DL4 (MEGA.HEX)

Daleks

- MAUG's DL4 (DALEKS.HEX, DALEK.DOC)
- Club Mac BBS (DALEK.APL)
- Stanford MUG Disk #1

Life (Bill Atkinson)

- MAUG's DL5 (LIFE.HEX)
- Club Mac BBS (LIFE.APL)
- NYMUG Disk #3

LAZlife

- MAUG's DL3 (NLIFE.HQX)

Life (Peter C. De Mars)

- MAUG's DL3 (NULIFE.HQX, plus 14 other Life-form files locatable with the keyword Life)

Water

- MAUG's DL3 (STD.H, WATEVE.C, WATGRA.C, WATMEN.C, WATOPE.C, WATOR.C, WATOR.H, WATOR.HCX, WATOR.LNK, WATORU.C, WATPAR.C)

Reversi

- MAUG's DL4 (REVERSI.HEX, REVERSI.DOC)
- Club Mac BBS (REVERS.APL)
- NYMUG Disk #6

Iago

- MAUG's DL4 (IAGO.HEX)
- Stanford MUG Disk #1

Backgammon

- MAUG's DL4 (BACKGA.HCX)
- Club Mac BBS (BACGAM.APL)

Mastermind

- MAUG's DL3 (MASTER.BAS)
- Club Mac BBS (MSTMND.APL)

Go (MS-BASIC)

- MAUG's DL4 (GO.BAS, GORULE.TXT)
- NYMUG Disk #4

Go (MacForth)

- send \$10 to Bruce F. Webster, 6215 Thorn Street, San Diego, CA 92115 (price includes copy of Roulette)

Roulette

- send \$10 to Bruce F. Webster, 6215 Thorn Street, San Diego, CA 92115 (price includes copy of Go)

MacPaint Patterns

- MAUG's DL3 (PATRNS.HCX, PATRN1.HCX, PATRN2.HCX)

Music-Cassette Labels

- MAUG's DL3 (TAPE2.HCX)

Diskette Labels

- MAUG's DL3 (LABELS.HEX, LABEL1.HCX, LABEL2.HCX)

Cut 'n' Paste Demo

- NYMUG Disk #4

MacMusic Demo

- MAUG's DL6 (MACMUS.HQX, MUSFN.HQX, plus music files you can locate with the keyword MacMusic)

Tumbling Mac Demo

- MAUG's DL4 (DEMO3D.HQX)

Smoothtalker Demo

- MAUG's DL4 (TALKER.HCX, PICTS.HCX)

Home Budget Template

- (Multiplan)
- Club Mac BBS (BUDGET.MMP)

Payroll Template (Multiplan)

- MAUG's DL3 (PAYROL.MP, PAYROL.DOC)

Income-Tax Template (Multiplan)

- MAUG's DL4 (TAX84.HQX, SCHEDA.HQX, SCHEDC.HQX, TAXES.DOC)

Filevision templates

- Berkeley MUG Disk #5
- Telos Software Products, 3420 Ocean Park Blvd., Santa Monica, CA 90405; (213) 450-2424
- Club Mac BBS (any file with the extension .FV)

"Louie, Louie" (MusicWorks)

- MAUG's DL6 (Louie.HCX)

"Jesu, Joy of Man's Desiring" (MusicWorks)

- MAUG's DL6 (BACH.147)

Praetorius, *Ballet de la Royne* (MusicWorks)

- MAUG's DL6 (BRNLE.HCX, 2BRNLE.HCX, BRNLEA.HCX, BRNLEB.HCX, BRNLED.HCX, BRNLEF.HCX, BRNLEG.HCX, BRNLEH.HCX, BRNLST.HCX, BRNDOC.HCX)

Jukebox

- MAUG's DL6 (MWJUKE.HCX, JUKEDO.TXT)

Renaissance music transcribed for MusicWorks (Richard Rae)

- Richard Rae, 1863 Centurion Parkway, Indianapolis, IN 46260

ORGANIZATIONS

New York MacUser's Group

P.O. Box 6686
Yorkville Station
New York, NY 10128
Annual membership: \$32

Club Mac

735 Walnut
Boulder, CO 80302
(303) 449-5533
Annual membership: \$35

Micronet Apple Users Group (MAUG)

CompuServe
5000 Arlington Centre Blvd.
P.O. Box 20212
Columbus, OH 43220
(800) 848-8990 (contiguous U.S.)
(614) 457-8650 (Ohio)

Berkeley Macintosh Users Group

1442A Walnut Street, Suite #153
Berkeley, CA 94709
(415) 849-9114
Semester membership: \$15

Stanford Macintosh Users' Group

P.O. Box 6508
Stanford, CA 94305
Annual membership: \$15

The Public Domain Exchange

673 Hermitage Place, Suite 5
San Jose, CA 95134
Complete Catalog: \$2

Note: these sources are provided to help you locate the software that interests you—they are not by any means the only places these programs can be found.

HARDWARE/SOFTWARE/BY SUE CRISSMAN

*An ultrahigh-
resolution digitizer for
the Macintosh*

ThunderScan

to be able to transfer your artwork to a Macintosh screen, where you can change the brightness and contrast, enlarge or reduce the image size, and edit with MacPaint, you'll be interested in ThunderScan. You can work with images of photographs, forms, maps, charts, halftones, and illustrations; in fact, you can work with just about anything you can roll through your Imagewriter printer.

In anticipation of working with ThunderScan, I'd collected all sorts of things I thought I'd want to play around with. So, with my stack of pictures in hand, I opened the ThunderScan box. ThunderScan consists of an optical-scanning cartridge, including a cable with an adapter box to connect the cartridge to your Macintosh; the software to make it all work; and, of course, a users' manual. The most unusual item is the digitizer cartridge or scanner, which resembles a cross between an Imagewriter ribbon cartridge and a hand-held price-tag scanner such as ones you may have seen in department stores.

From Setup to Scanning

Because I was looking at a piece of hardware, I decided to read the manual for a change, rather than just forging ahead. When I read manuals, I usually plow through them until I get bored or till I no longer understand what they're talking about—anywhere from 2 to 20 pages. The ThunderScan manual is 60 pages long and is liberally sprinkled with photos and graphics. I ended up reading the entire manual before I began—a first for me, and a statement about the quality of the documentation. When I later referred to the manual for specifics, I found what I wanted quickly and easily. This documentation is some of



MacPaint for the rest of us." That's how Andy Hertzfeld, who wrote the the application software, describes ThunderScan, an ultrahigh-resolution digitizer for the Macintosh.

If you've been longing to have elaborate graphics on your Macintosh screen and you're one of those people who can't draw a straight line with a ruler, ThunderScan provides a solution. If you *can* draw, and you'd like





NEW!
NYBILS™
THE SOFT-WEAR MOUSE
FOR MACINTOSH & II MICE

Send \$9.95 + \$1.50 shipping & handling
to Foresight Designs, P.O. Box 70
Southeastern, PA 19399. PA residents include
\$.60 sales tax. Dealer inquires welcome.

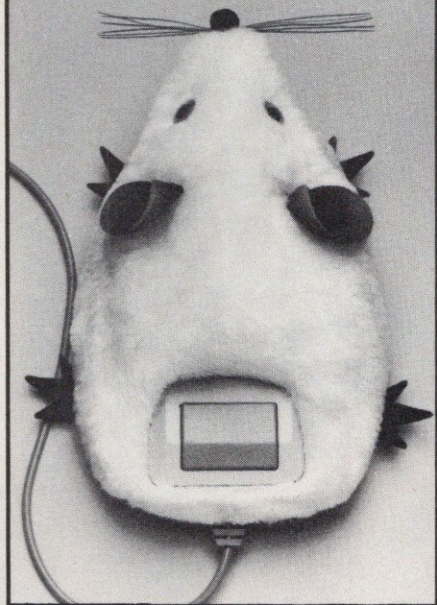

CIRCLE 204 ON READER SERVICE CARD

RETAILERS TAKE NOTE!



Create an educated and aware customer with A+, *The Independent Guide For Apple Computing!* Every issue brings your customer new ways of using their microcomputer PLUS it's a "silent salesperson," helping users select new peripherals, software and hardware. If you're interested in a low ticket item that's efficient, effective and profitable, call us today! CALL 212-503-5380!

Or write:
Ziff-Davis
Publishing Company
Retail Sales Department
One Park Avenue
4th Floor
New York, NY 10016

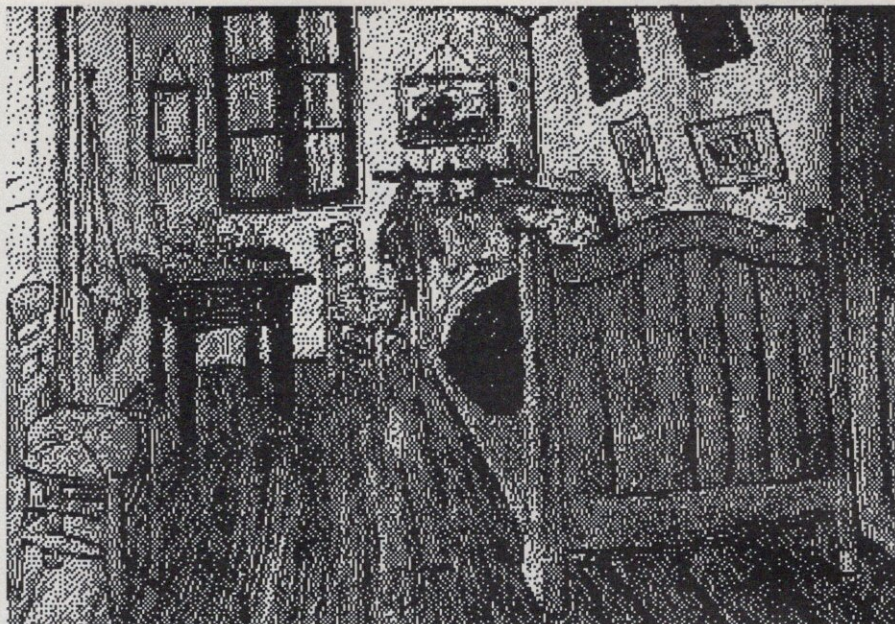

Figure 1: ThunderScan image of Van Gogh's 'Room at Arles'

the best I've seen for the Mac.

Installation requires only a screwdriver. You attach the adapter box to the printer socket on the back of your Mac and then plug the Imagewriter cable into the socket on the adapter box. The box contains a switch that enables you to change from scanning to printing. The ThunderScan software also contains a split-port option, so you can leave the Imagewriter connected to the printer socket and connect the adapter box to the modem socket if you wish. Before installing the scanner cartridge, check the DIP-switch settings of the Imagewriter. ThunderScan includes a notice telling you about these switches, but you might easily overlook it.

To install the digitizer cartridge, you remove the ribbon and snap the cartridge in its place; ThunderScan provides a special plastic printer cover to use while scanning. After you've installed the scanner and adapter box, your Imagewriter has, in effect, become an "image reader" that scans pictures as they feed through it. The scanner moves back and forth across the page, translating each point it sees into a dot corresponding to one of 32 shades of gray. Although your Macintosh can show only black or white dots, the ThunderScan "gray map" figures out exactly which dots to include in order to represent the image

you're scanning. After you have scanned the image, you can work with the gray map and change the contrast and brightness to enhance the picture and produce a final image that is exactly what you want.

Once you've installed the hardware and booted the software, you're ready to scan images. ThunderScan provides a sample image and a tutorial to help you learn the basics. You first focus the scanner by positioning it over a white area to be scanned, choosing a command from a menu, and then adjusting the knob on the scanner until a maximum number appears on your screen.

To scan your image, you choose Scan from the Scanner menu. Doing so brings up the Page Map dialog box, which allows you to select the area of your document you wish to scan and choose whether to reduce or enlarge it or leave it in its original size. Depending on the amount of memory available in the computer, you can enlarge an image up to 400% or reduce it to 25% of its original size.

Clicking on New Scan begins the scanning process. You can save the image as a ThunderScan document, complete with gray-map information, or as a MacPaint document. At this point, you can enhance, edit, or print the image. Actual scan time depends on the size of the image being scanned. Setting up the system and creating my first image took me less than an hour.

Once the image has been scanned, you can use ThunderScan to fine-tune the final product. In addition to

contrast and brightness adjustments, you'll see a tool palette with a pencil, eraser, selection rectangle, and hand symbol (sometimes known as the grabber), which generally work the way they do in MacPaint.

ThunderScan has an added feature called auto-scrolling. When you want to move your document around on the screen, you press the mouse button; push the hand a little; and, while it's still moving, release the mouse button. The image continues to move until you click the mouse button again. This procedure is a vast improvement over the constant dragging you need to do to get the same effect in MacPaint. Auto-scrolling even has two speeds, so you can move slowly or quickly across parts of your image. With the selection rectangle, you select parts of the image to work with; you can also use the Select All command from the Edit menu. The pencil and eraser work as you expect them to, and there is a Fat-Bits command as well.

With ThunderScan you can adjust the halftone of the images you have scanned. When ThunderScan scans an image, it produces a halftone that shows a smooth transition from the black areas to the white areas of the image. If you don't know the difference between a halftone and a quarter note, you can easily get a sense of what it's all about by selecting areas of your image and changing the brightness and contrast settings on the screen. Once you've selected an area and set the contrast and/or brightness settings, you choose Halftone from the Scanner menu to see the results. If the image is too dark or too light, adjust the brightness control. Adjusting the contrast control varies the difference between light and dark in the image. The High Contrast command lets you produce stark black-and-white images with little gray in them, the Invert command lets you change all the black dots in your image to white, and vice versa.

ThunderScan's Cut, Copy, and Paste commands are similar to the same commands in MacPaint, with an additional feature. You can enlarge or shrink the size of the image you're copying by selecting an area for pasting that is larger or smaller than the original part of the image you copied. The new image will be sized to conform to the size of the rectangle you draw to receive it. To paste an image

Creating my first image took me less than an hour.

in its original size, you simply click at the destination of the upper-left corner of the pasted image.

ThunderScan is called an ultra-high-resolution program because of the amount of information it can encode about a picture. Documents are digitized to resolutions exceeding 200

dots per inch, with 32 levels of gray scale. Although this amount of information is more than your ImageWriter printer can deal with, the Apple LaserWriter printer will be able to print your documents with this degree of resolution, giving you extremely-high-quality representations. The original version of ThunderScan does not work with the LaserWriter, but a revision is on the way that will allow you to print images you've previously scanned with the ImageWriter, directly to the LaserWriter.

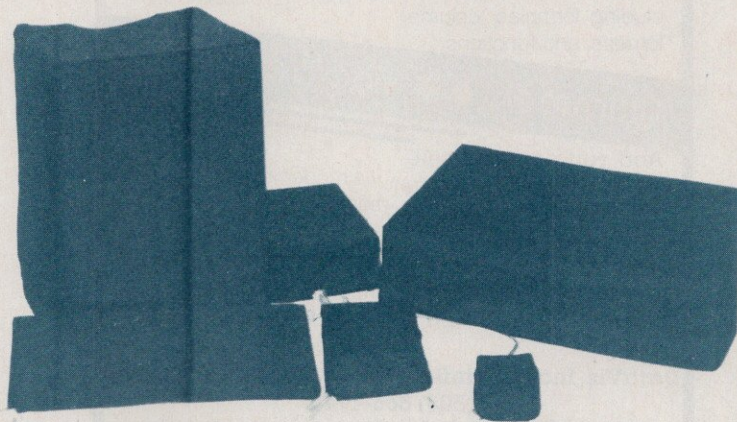

Mec Enterprises Inc.

Cover your computer in the style it deserves. Introducing the MecCover From Mec Enterprises. Comes in a variety of colors, made of a durable, carefree material. Available in sets or separately. 65% Polyester 35% Cotton, Machine washable.

Macintosh	<input type="checkbox"/> Grey	<input type="checkbox"/> The Macintosh set includes:
Macintosh XL	<input type="checkbox"/> Maroon	<input type="checkbox"/> computer, keyboard, mouse,
Apple IIE	<input type="checkbox"/> Khaki	<input type="checkbox"/> & printer. All sets are. <input type="checkbox"/> \$28.00
Apple IIC	<input type="checkbox"/> Forest Green	<input type="checkbox"/> Computer cover <input type="checkbox"/> \$10.95
IBM PC	<input type="checkbox"/> Navy	<input type="checkbox"/> Keyboard cover <input type="checkbox"/> \$8.95
IBM PC jr	<input type="checkbox"/> Brown	<input type="checkbox"/> Mouse cover <input type="checkbox"/> \$4.50
AT&T PCX	<input type="checkbox"/> Rust	<input type="checkbox"/> External disk drive <input type="checkbox"/> \$6.50
AT&T	<input type="checkbox"/> Bluestone	<input type="checkbox"/> Printer <input type="checkbox"/> \$10.95
Dealer Inquiries Welcome		Numeric keypad Mac <input type="checkbox"/> \$6.50
		The Bernoulli box <input type="checkbox"/> \$7.50

Treat your computer with the care it deserves!!!!
FOR MORE INFORMATION OR TO PLACE AN ORDER,
CHECK BOXES AND MAIL IN WITH CHECK OR MONEY ORDER
OR CONTACT:

Mec Enterprises Inc.
P.O. Box 9206 Ogden, Ut. 84409
(801)392-6663

PLEASE ADD \$3.00
FOR SHIPPING AND
HANDLING.

PLEASE ADD STATE SALES TAX

VISA & MASTERCARD
ACCEPTED.

PLEASE ALLOW 4 TO 6 WEEKS FOR DELIVERY

NO C.O.D.'S PLEASE

MACINTOSH, MACINTOSH XL, APPLE IIE, APPLE IIC, ARE ALL REGISTERED TRADEMARKS OF APPLE COMPUTER INC. IBM PC IS A REGISTERED TRADEMARK OF IBM. AT&T IS A REGISTERED TRADEMARK OF AT&T. DIGITAL IS A REGISTERED TRADEMARK OF DIGITAL COMPUTER INC. THE BERNOULLI BOX IS A REGISTERED TRADEMARK OF IOMEGA.

MacLink

...the "intelligent" link between
your Macintosh and the IBM PC

MacLink allows you to translate spreadsheet and word-processing files between the Macintosh and the IBM PC...easily and quickly.

Now you can translate spreadsheets between Lotus on the PC and Multiplan on the Mac...including formulas, column formats, and functions.

And MacLink allows you to transfer any other type of file between the two machines as well...including binary, comma-delimited, DIF, SYLK, and text files.

MacLink's integrated communications and unique translators work

Unique PC ↔ Mac Translators!

And you can translate documents between Wordstar or Multimate on the PC and MacWrite on the Mac...including margin settings, paragraphing, columns, and print styles.

via modems or with an optional PC to Mac cable.

The cost is just \$125: This includes the MacLink manual, and a MacLink disk for both the PC and the Mac.

DataViz, Inc. - 16 Winfield Street - Norwalk, CT 06855
(203) 866-4944

Trademarks: IBM, Lotus, Macintosh, MacWrite, Multimate, Multiplan, Wordstar

CIRCLE 333 ON READER SERVICE CARD

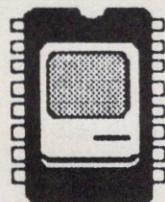

512K!

MacMemory Electronics is pleased to announce an easy-to-install 512K upgrade kit for Macintosh. Our kits are the "Electronic Twin™" of the factory 512K machine. Compatibility is guaranteed.

The MacMemory Upgrade is also available fully assembled and tested with a 90-day warranty.

Why pay more for the same thing?

Order your MacMemory Upgrade today!

\$249.00 MacMemory Upgrade Installed

\$175.00 MacMemory Upgrade Kit

\$ 9.50 Case Removal Tool

Installed Orders: Send \$12.50 for case removal tool, instructions, and shipping container for your old 128K board. We ship an assembled 512K board via UPS Air the same day we receive your 128K board and payment for the upgrade.

Kit Orders: Add \$4.50 Shipping. Removal tool required to open case.

Payment is by VISA, MASTERCARD, check, or C.O.D.
CA Residents add 6% Sales Tax.

MacMemory Electronics

500 W. Middlefield Rd., Suite 28

Mountain View, CA 94043 (415) 964-4176



CIRCLE 132 ON READER SERVICE CARD

The new version will contain some other minor changes and will be available to current owners of the program at a nominal fee.

ThunderScan's level of precision actually can make life harder for a novice. When I attempted to make an image of a map, ThunderScan was so sensitive that it even picked up wrinkles and translated them into gray patterns. I also had problems working with a postcard and a Polaroid photo. Although you get a special plastic "carrier" sheet that you can tape a small picture to, the pictures didn't feed through the Imagewriter as well as I had anticipated.



If you do try to scan things that are too thick, you may have problems. If you're in the habit of unjamming your printer paper while you're printing, do *not* try to help thick objects feed through the Imagewriter while you're scanning. I moved the roller shaft (it used to be called a "paper bail") back while scanning; the result was a disheartening crunch as the scanner ran into the roller shaft and scanning stopped. Fortunately, neither the software nor the hardware suffered permanent damage.

Even if you can feed a thicker object through properly, you may have problems with the results being too dark. The message is clear; when the Thunderware people say your image must be flat, they mean *flat*. You'll have to make a photocopy of anything thicker than a sheet of paper. In the process, of course, you'll lose some of the resolution quality.

ThunderScan also takes a lot of memory and disk space. If you're working with a 128K Macintosh and a single disk drive, the size of what you'll be able to scan is quite limited. You can work with an 8 x 10-inch image by reducing the magnification to 86%. Don't expect to be able to enlarge a drawing that size by 400%, though. Of course, working with a document four times the size of an average sheet of paper is difficult, given the size of the Mac screen and the limits of the Imagewriter.

Because ThunderScan writes information to disk when you run out of memory, you'll want to follow the tips in the manual for customizing your disks to make the best use of space. With a 128K Macintosh, for

example, you should put the system folder on a disk in the internal drive and the ThunderScan application on a disk in the external drive.

Format First

Speaking of disks and drives, I tried to save a scanned image onto an unformatted disk I inserted in the external drive after I had been working with ThunderScan in the internal drive. I'd already received a message about not having enough disk space, so I expected to save the image on a new disk. Instead of asking me if I wanted to initialize the disk, the program told me: AN INPUT/OUTPUT ERROR HAS OCCURRED. Since I didn't have enough room on my application disk, I was unable to save the image as a ThunderScan document. I was able to save it as a MacPaint document, however, but I lost all the gray-shade information. Once you've experienced this problem, you'll remember to keep a properly initialized disk around when you're using ThunderScan.

Scanning is an easy process, but it can be time-consuming. Because of the quantity of information ThunderScan can encode, scanning a large image can take as long as half an hour. To speed up the process, you can choose to scan bidirectionally—you'll lose a bit of resolution but save some time. If you wish, you can scan images without keeping the gray-shade information. This technique speeds up the process, but you won't be able to change the contrast or brightness. The features that give ThunderScan its ultrahigh resolution are what make it work more slowly than you might like. If you want to give up some of the special features, you can work faster, but if you want a higher-quality image, it will take longer. The resolution ThunderScan provides is extremely high, and

you'll probably find the extra time investment worthwhile.

What makes ThunderScan unique is the quality of the images you can produce and the ease of producing them. If you just want to copy images without all the extras, you can do that, but ThunderScan really shines when you adjust the gray-shade information. You can create your own high-quality clip art, paste illustrations into reports, and copy photographs (as long as they're thin and flat). ThunderScan would be in-

valuable in producing newsletters, and you could also use it to make high-quality overhead projection art.

Other digitizers allow you to capture different kinds of images, some by using a camera or video camera. I'll review several of them next month. If your primary interest is recreating flat pictures with ultrahigh resolution, ThunderScan is the product for you. Especially in combination with a LaserWriter printer, it will give you the highest-quality graphics possible with a Macintosh. +

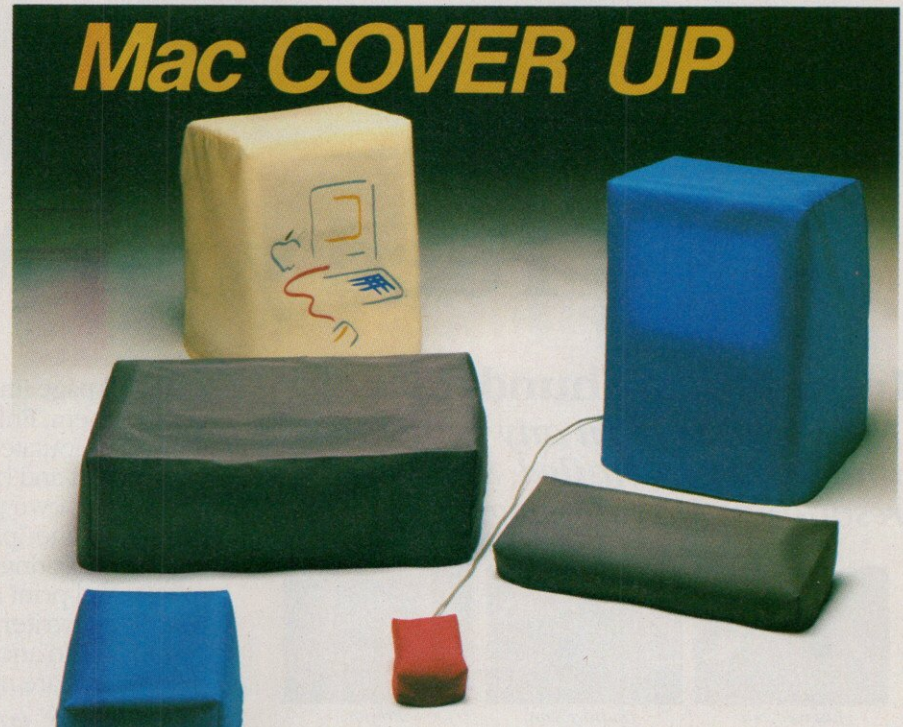

Mac COVER UP

Your Macintosh is not just a computer. It's a part of your business and a part of your life. It's just like family, and it deserves the best of care. So put on a 'COVER UP' and see how great your Mac will look while being protected from dust and spilled liquids. 'COVER UPS' are custom designed to fit like a glove, and yet allow very easy access to your Mac. With our 'COVER UPS', you can arrange your hardware any way you like. An individual 'COVER UP' is available for each component in your system. So after a long day with Mac, you won't have to rearrange your hardware when you shut down. Just 'COVER UP'. Save time, and save your Mac, in one of seven beautiful colors, from tan to blue to bone (same as the color of the Macintosh).

Set #	Contents	Sug. Retail*	Set #	Contents	Sug. Retail*
MACINTOSH SETS					
#M1	Macintosh, KYBD, Mouse, Imagerwriter	\$29.95	#C1	Apple IIc KYBD and Monitor	\$18.95
#M2	Macintosh, KYBD, Mouse, Imagerwriter, and Ext. Disk Drive	\$31.95	#C2	Apple IIc KYBD, Monitor, and Ext. Disk Drive	\$24.95
#M4	Macintosh, KYBD, Mouse, Imagerwriter, Ext. Disk Drive, and Numeric Ten Key	\$32.95	APPLE IIe SET		
MACINTOSH XL SETS					
#L1	Macintosh XL with Profile Piggyback	\$25.95	#E1	Apple IIe KYBD, Monitor, and Ext. Disk Drive	\$25.95
#L2	Macintosh XL 2/5, 2/10	\$23.95	#E2	Pro Model with Duodisk	\$25.95
					*Shipping and Handling UPS ground add \$3.00
					*Shipping and Handling UPS 2nd day air add \$4.00
					*We accept Visa and MasterCard

These are just a few of the 'COVER UPS' available. For a complete product list circle reader number below, or call in order and receive special A+ readers discount.



Computer Cover Co.

P.O. Box 3080, Laguna Hills, CA 92654
CA (714) 380-0085 Others (800) 235-5330

Dealer Inquiries Invited

Macintosh, Apple IIe, IIc, Mac XL are all registered trademarks of Apple computer.

NEW PRODUCT Now you can take it with you, your diskettes that is. New 'SOFT PAK' makes it possible. Attractive pocket size (3 1/2") diskette carriers. Two sizes available now. 4 or 6 Pak.

Sue Crissman is a Bay Area writer and consultant and a contributing editor to A+. Her consulting clients include Apple and other computer companies, for whom she designs and writes training, sales, and promotional materials.

PRODUCT INFORMATION

ThunderScan

ThunderWare, Inc.
19-G Orinda Way
Orinda, CA 94563
(415) 254-6851

List Price: \$229

CIRCLE 501 ON READER SERVICE CARD

CIRCLE 163 ON READER SERVICE CARD

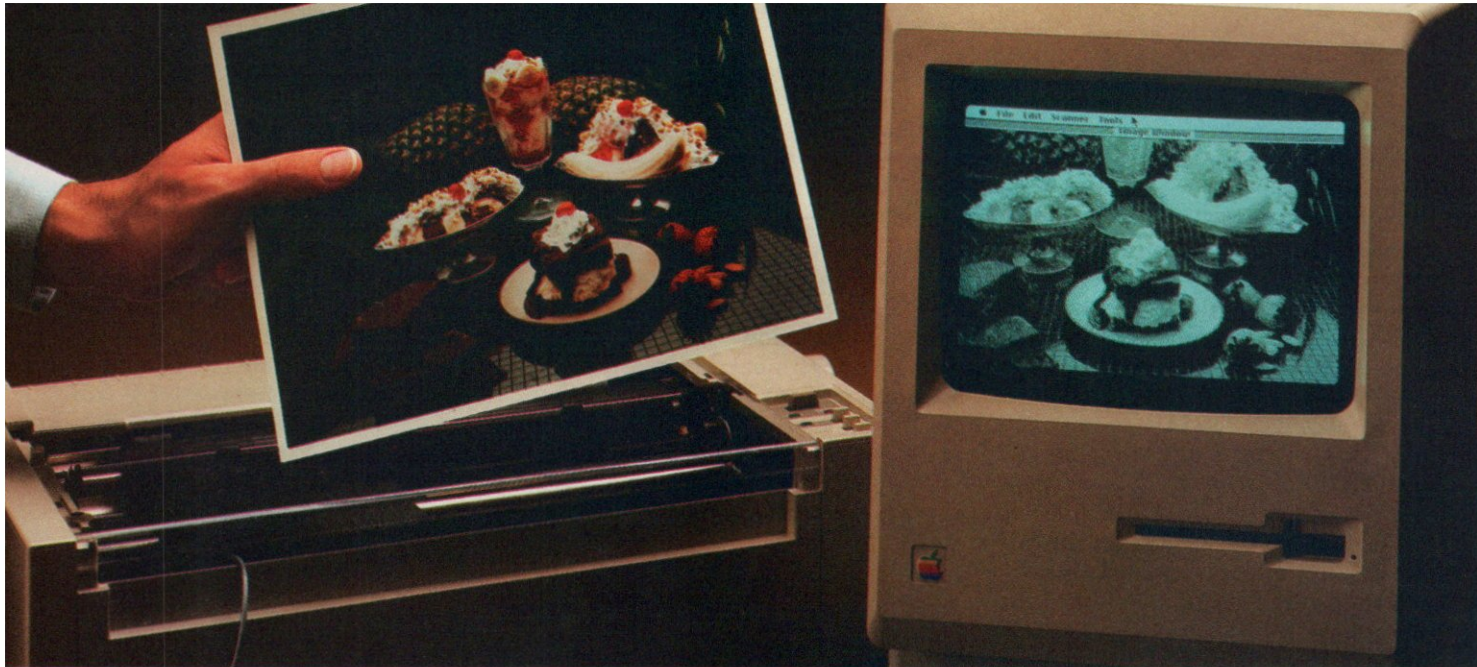

Feed your Mac.

Introducing ThunderScan.™

Now you can turn any printed image into a detailed, high-resolution Macintosh graphic.



Just roll your original into your Imagewriter.



ThunderScan scans and digitizes the image.



Presto! A high-resolution MacPaint document.

No doubt about it, Macintosh is one great graphics machine. But until now, Mac graphics have been limited to what you can draw with a mouse and what someone else has put on a disk. Consequently, taking full advantage of Mac's graphics capabilities has been tough. But now there's ThunderScan. The new optical scanning device that lets you feed your Mac a steady diet of graphics that are useful to you.

ThunderScan turns Mac's Imagewriter printer into an image reader. So you can digitize any printed image and turn it into a detailed, high-resolution MacPaint document. Anything, including forms, half-tones, photos, mechanical drawings, maps, floorplans, logos, signatures and more. From black and white and color originals. ThunderScan reproduces them at over 200 dots per inch and in 32 shades of gray.

ThunderScan's application software, written by Mac-team-member, Andy Hertzfeld, makes it an extremely versatile and useful tool. You can gen-

erate full-page images or selected parts of them. Enlarge and reduce them. Manipulate them. Control the contrast and brightness. Create your own personal image disk. "Cut" and "paste" images together, creating new documents. And print them out on your Imagewriter. Or send them by modem to another Mac. The possibilities are nearly endless.

No lights, no camera, just action.

What you see here is the complete ThunderScan system. You don't have to buy an expensive video camera. Just pop out your Imagewriter's ribbon cartridge, snap in ThunderScan and you're set. It can even work in the dark (maybe you can think of an application for that).

If you bought a Mac at least partly for its graphics, only to find you couldn't take full advantage of them, now you can. With ThunderScan.

At an introductory price of just \$229, it's a small price to pay for a whole new graphics capability.

For more information or a ThunderScan of your own, see your dealer or call us today.

(415) 254-6581

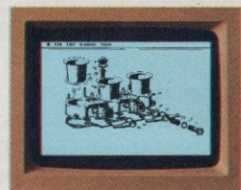

ThunderScan

Thunderware Inc., 21 Orinda Way, Orinda, CA 94563

MacTips

Suggestions from our readers

MAXIMIZING MACPAINT

The following excerpts and tips about how to get more out of MacPaint are from a talk by Apple's Bill Atkinson, programmer of MacPaint, at the MacWorld Exposition in San Francisco (February 1985). Many of these tips explain techniques in the Shortcuts Help screen from the Goodies menu (see figure 1).

Undo

The top left key, the tilde, undoes your last action, as does Control-Z. If you hold down the Undo key continuously, you can get an animation effect.

Clear

The top right key, the Backspace key, clears whatever is in the selection rectangle or lasso.

Multiple-Key-Combination Rule

Press and hold down the desired special keys, hold the mouse button down, initiate the mouse motion, let go of the keys, and move the mouse with the button held down until you are done. Once the mouse starts moving, it knows what it is going to do, so

you can release the special keys.

Constrain

You use the Shift key to limit tool movement to horizontal, vertical, or 45° lines with the \backslash or $/$ and circles with the oval tool. This technique is useful with the following tools: Eraser, Brush, FatBits, Spray Paint, Scroll, Show Page, Select, and Drag.

Multiple Copy

After defining the image you wish to copy, with the box or lasso selection tools, press the Option and \mathcal{H} keys. Then hold down the mouse button, initiate mouse motion, let go of the keys, and move the mouse to get multiple copies.

Multiple-Copy Spacing

Rapidly moving the mouse produces unevenly spaced copies of a selected image, but moving the mouse slowly produces evenly spaced ones. Select a line width from the Line Width box to determine the space between copies. For instance, to make a curved, dashed line, lasso a single dot, hold down the option and \mathcal{H} keys, and select a line width to

control the spacing of the dashed pattern (see figures 2 and 3).

Three-Finger Stretch

To constrain multiple copies, hold down the Shift key, the Option key, and the \mathcal{H} key. This stretches or shrinks shapes you've outlined with the selection tools or lasso. (You don't have to remember which special keys to use because you employ all of them.) To maintain a pattern when stretching an image, use the Grid option in the Goodies menu (see figure 4).



Even spacing occurs by the width selected in thickness box and slow movement of the mouse while using the multiple copy technique.

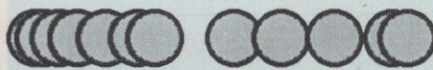

Uneven spacing occurs with rapid movement of the mouse while using the multiple copy technique.

Figure 2: Examples of using the Multiple Copies technique

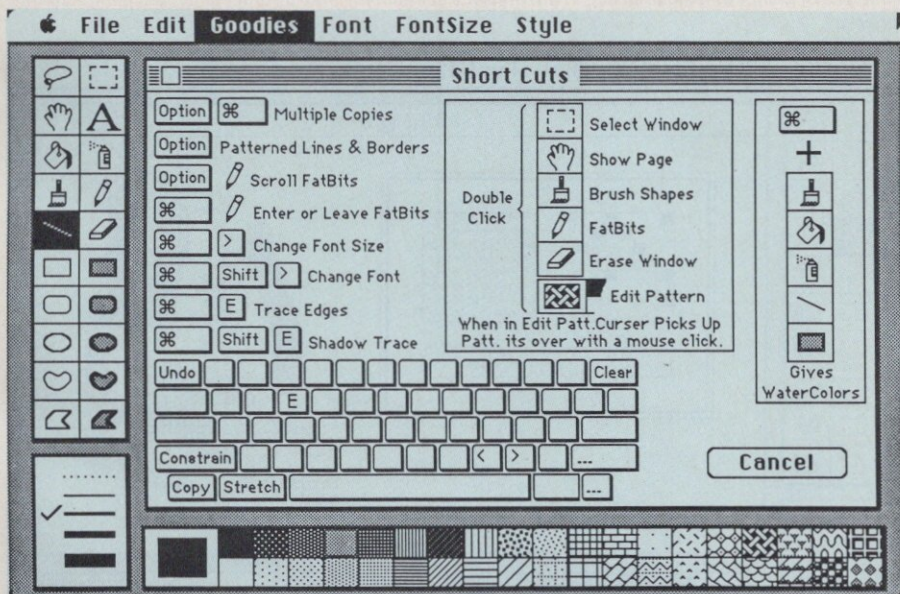

Figure 1: The MacPaint Shortcuts Help screen from the Goodies menu. Note the addition of the Gives WaterColors box. You can find this modified Help screen in the MAUG section of CompuServe or through users' groups and add it to your MacPaint program.

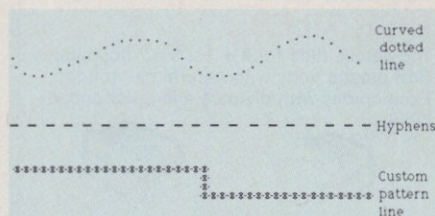

Figure 3: Using the Multiple Copies technique to achieve different spacing effects

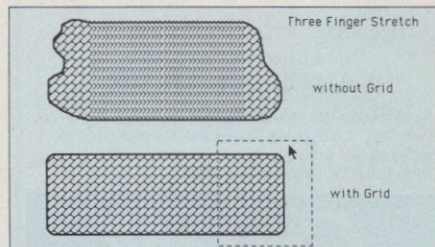

Figure 4: Using the Three-Finger Stretch technique with the Grid option selected maintains the patterns within the stretched image.

MacTips



VERIFLEX

Free plastic library case.

Lifetime warranty.



50 + 100 +
Price Each

5 1/4" Single Sided/
Double Density99 .94

5 1/4" Double Sided/
Double Density 1.09 1.04

From the inventors of the 3 1/2" Micro Disk . . .

SONY

Ten-pack, boxed diskettes.

20 + 50 + 100 +
Price Each



3 1/2" Single Sided/
Double Density 2.28 2.25 2.19

3 1/2" Double Sided/
Double Density 3.45 3.39 3.35

5 1/4" Single Sided/
Double Density — 1.29 1.25

5 1/4" Double Sided/
Double Density — 1.59 1.55

APPLE IMAGEWRITER RIBBONS



\$3.69 each



Many other models available.
Boxed in dozens.

DISK FILES

The deluxe files for 3 1/2" or 5 1/4" floppies. Buff plastic body with natural oak roll-top. Each comes with dividers and color coded labels.



for 3 1/2" holds 55 **\$17.49** for 5 1/4" holds 140 **\$24.99**
Other colors and locking models available.

CALL TOLL FREE **1-800-USA-FLEX**

7 to 7 Central Standard Time

IN ILLINOIS 1-312-351-9700

Please mention this ad when calling in your order. MasterCard, Visa, C.O.D. or Net 30 days with approved credit on purchases over \$200.00. Shipping/Handling additional. Prices subject to change without notice.

COMARK

COMARK, INC. 135 N. Brandon
Glendale Heights, Illinois 60139

Transparent Paint

If you hold down the ⌘ key while painting, you'll get effects such as those in figure 5.

MACPAINT SHORTCUTS

Entry to and Exit from FatBits

With the Pencil tool selected, hold down the ⌘ key. If you do not make any marks but press the mouse button, you will jump into and out of FatBits at the location of the pencil point.

If you hold down the Option key, the cursor will temporarily convert into the hand so you can scroll. Release the Option key, and you can edit with the pencil, press the Option key again and scroll, and so on. This technique is handy because FatBits is so magnified and has such a narrow field of view that reaching almost

anything you want to edit requires a little bit of scrolling.

Incomplete Lasso

When you select an image with the lasso but do not complete the lasso, MacPaint connects the ends with a straight line.

Stretching/Shrinking

You can stretch or shrink an image outlined by a selection rectangle by holding down the ⌘ key and pressing the mouse button while the pointer is on one of the flashing edges of the rectangle. If you grab the image in the middle of an edge, you can stretch it only in the direction of the edge, but if you grab the image near a corner, you can stretch it in any direction. You can also stretch or shrink an image by pasting an image into a large

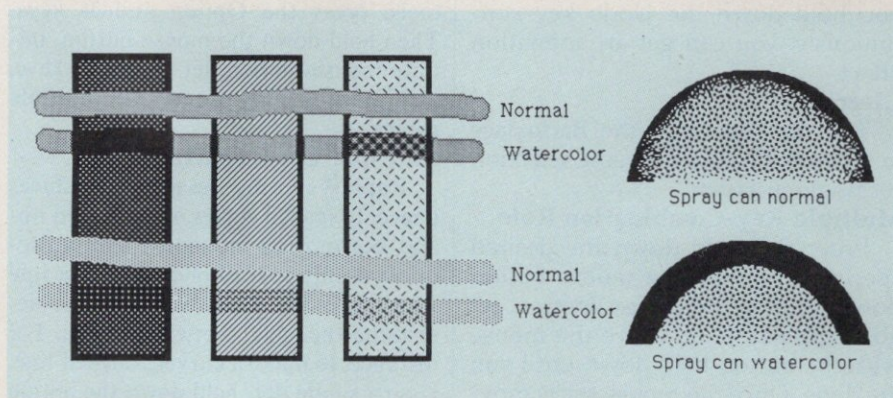

Figure 5: If you hold down the ⌘ key while painting, you will get a watercolor effect (above left). This use of the Transparent Paint mode (above, right) prevents overlapping onto a border when you paint with the spray can.

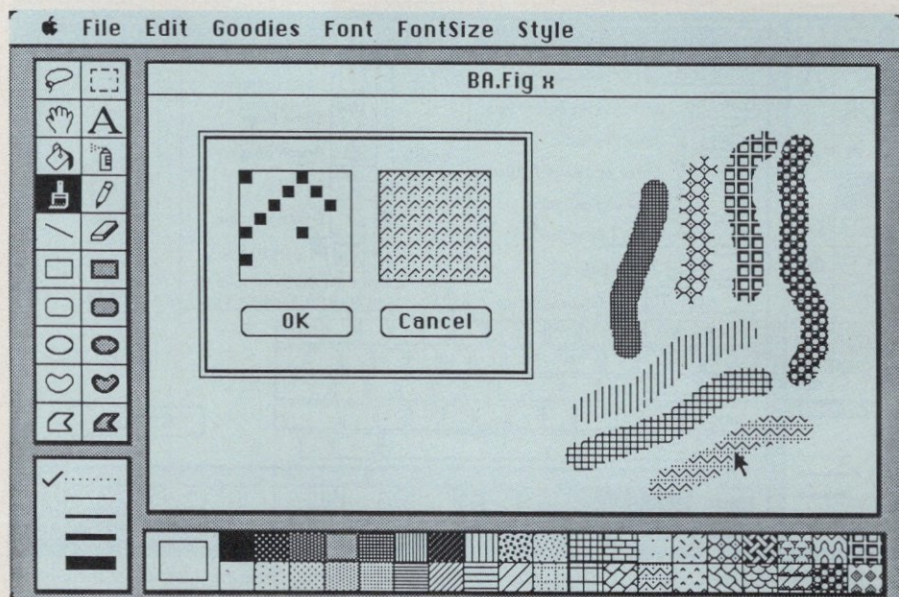
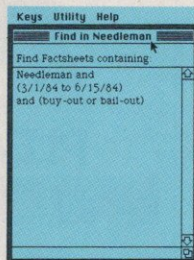

Figure 6: You can pick up any pattern on the screen and edit it with the Pattern Pickup technique.

It's easy with Factfinder.™ Because Factfinder is a kind of electronic "desk-drawer" where you can just toss information without worrying about how it should be arranged or how you might want to use it. There are no fields to define, no formats to set up.

When you need to find all the clients you have who hate olives or live in Denver; when you want to collect your notes on pasta merchandising; when you need the name and number of that guy who's looking for leveraged buyouts, it's yours in a few seconds, at your index fingertip.

You just key in your notes on the Needleman Plan (or Needleman vs. Nardoff or the Needleman Noodles campaign) in any length you want, and click the mouse on a



few key words—"fallout," "bail out," "roll-out," "leveraged buyout," whatever.

Then, any of those words or part of those words will bring you a stack of notes you've made that include "Needleman," or "leveraged buyouts," "national rollouts" or miracle "bail-outs." Or you can request Factfinder to get you the Factsheet that contains "Needleman" and "bail-out." Or you can ask for anything that mentions "bail-out" or "Needleman."

And Factfinder has all kinds of features like zoom and automatic wrap to help you manipulate the heck out of your data, and make it whatever size and shape you want.

Contact your Macintosh™ software dealer, or call 1 800 MACWARE to find out where you can get Factfinder.

From Forethought, Inc.



MACWARE™

CIRCLE 127 ON READER SERVICE CARD

How to find a Needleman in a haystack.



Macintosh Programmer's Library

Affordable, Reliable Tools for Programmers

From the author of Pascal/MT+ Tardis Software presents the **Mac Programmer's Library**

A collection of tools for the serious Mac programmer. Tools which save you hours of work written by an experienced Macintosh programmer. Tardis Software is committed to giving you reliable tools at a good price. Order 3 and save 10%, order all 5 and save 20%!

The Macintosh Programmer's Library current contents:

- FastFinder - command-line oriented user-interface.
- ToolPak 1 - diff, search, dump ASM xref, librarian
- ToolPak 2 - c beautifier, tool subroutines (C source) and C xref
- C-leaner - expert system program, tells you where and how to optimize existing code
- MacMake - program maint. utility, simplifies re-builds

All are \$49.95! and are AVAILABLE NOW

MC/Visa. COD's and POs add \$5 for handling. Price incl. UPS ground, Blue Label add \$5

Tardis

Software

**2817 Sloat Road
Pebble Beach, CA**

(408) 372-1722

CIRCLE 215 ON READER SERVICE CARD

or small selection box.

Constrain Stretching/Shrinking

Holding down the Shift key while stretching or shrinking an image maintains the same aspect ratio.

Pattern Pickup

While the Edit Pattern window is on the screen, move the cursor to any point on the screen outside the window and click the mouse button, which will pick up whatever is at that point (see figure 6). Instead of going into FatBits, carefully looking at a pattern, and writing it down or dumping it onto the disk or printer, you can use this little-known feature. All patterns you create or pick up are also saved with the document.

Changing Font Features

⌘>, or ⌘<, increases or decreases text-font sizes. To change the font itself, use ⌘Shift >, or ⌘Shift <,. To change font sizes or styles within a single line of text, you can press Enter wherever you want the change and then make the change and continue typing.

OTHER TRICKS

Pattern Borders

If you hold down the Option key, any line or border you draw will come out in the pattern that you've selected.

Trace Edges

To make a box with a shadow, draw a borderless box filled with black. Grab the image with the selection rectangle and then press Shift ⌘E. The box turns white and the edges black, while the right and bottom edges are shadowed with an extra line of dots. Also try printing your name with the spray can or thick pencil. Grab the image with the selection rectangle and press ⌘E (see figure 7, below).

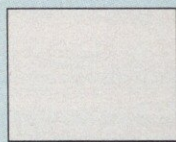

Figure 7: You can easily create shadowed boxes and outlined writing using the Trace Edges or Trace Edges Shadowed techniques.

FatBits Sizing

Nine dots in FatBits equals 1/8 inch (72 dots/inch).

Quick Eject and Reset

If you hold down the ⌘ key while selecting Quit from the File menu, the disk ejects, and the computer restarts. +

IF YOU SUBSCRIBE TO



PLEASE READ THIS

... Take a moment now and remove your mailing label and save it with this message. Your label is very important and helps us to help you quickly!

- When moving, send us your label with your new address 8 weeks before you move to A+, P.O. Box 2965, Boulder, Colorado 80322.
- If you have a question about your subscription, simply send us a note with your label, or a note with your name, address and Personal Identification Number to P.O. Box 2965, Boulder, Colorado 80322.

Your Expiration Date

OCT 83

Affix label here.

Your P.I.N.

802222

Your Name
Your Company
Address
City State Zip

Name _____

Company _____

Address _____

City _____ State _____ Zip _____

If you have just subscribed, you'll receive your first issue in 30 to 60 days.

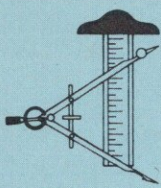

Introducing **idd**'s

MacDraft™

The Ultimate Drawing Package for the Macintosh™

MacDraft™ is the most powerful object oriented drawing tool available for the Macintosh™ today. Its ease of use, combined with its powerful capabilities, allows even the most casual user to produce professional looking drawings. The versatility of MacDraft™ makes it ideal for the beginner, as well as the professional.

Although MacDraft™ is powerful enough to create detailed drawings, schematic diagrams, organizational charts and business illustrations, it is also ideally suited for creating general sketches, greeting cards, and almost any other picture that you might want to draw.

Features

- Continuous drawing mode.
- 16 Different scales.
- Zoom In and Zoom Out.
- Automatic dimension lines.
- Circles by radius or diameter.
- Arcs by radius or 3-points.
- Distribute objects along a line.
- Rotate objects in 1 degree increments.
- Create objects by inside or outside diameter.
- 4 Separate documents on the screen at the same time.
- Paste illustrations to and from other documents.
- Paste pictures from MacPaint™.
- 64 Patterns for Fill & Ink.
- Flip objects.

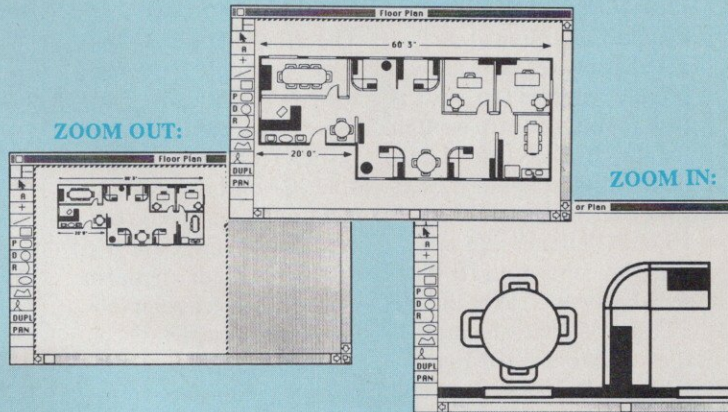

The Zoom functions allow you to see either a reduced or enlarged view of the drawing. Regardless of the view, you still have full access to all of the drawing capabilities of MacDraft™.

ZOOM OUT: to see your entire drawing, and also add large objects that may stretch beyond a normal view.

ZOOM IN: to add fine details to your drawing that may not be convenient to create at a normal view.

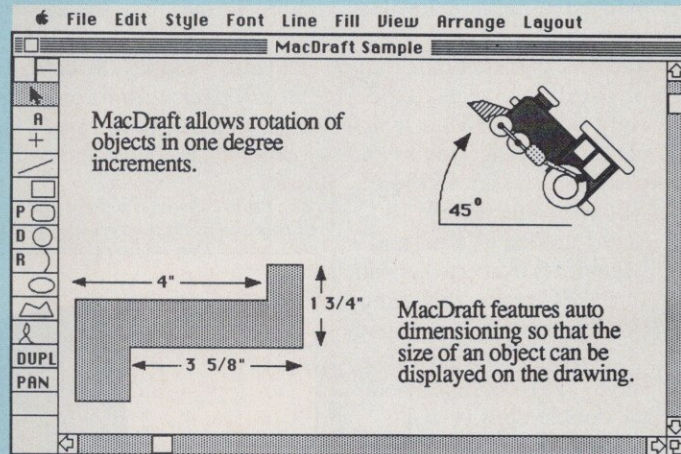

MacDraft™ offers 16 different scales to suit your needs.

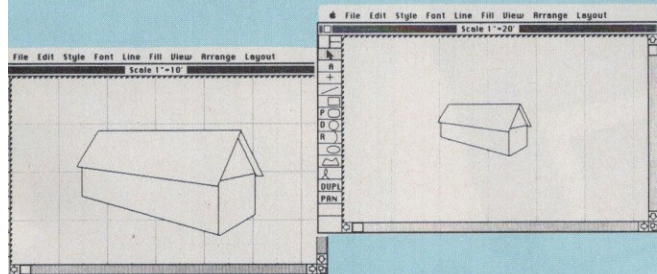

Objects created at one scale, can be pasted into a drawing at a different scale. The objects will reduce or enlarge to conform to the new scale. You may also change the scale of the entire drawing.

Draw your own conclusions, with MacDraft™. For more information, see your dealer or call us today.



Innovative Data Design, Inc.

1975 Willow Pass Road, Suite 8, Concord, California 94520 (415) 680-6818

MacDraft is a trademark of Innovative Data Design, Inc. Macintosh and MacPaint are trademarks licensed to Apple Computer, Inc.

CIRCLE 112 ON READER SERVICE CARD

M/C

► MACCHARLIE AND MACCHARLIE PLUS

Dayna Communications' new hardware/software product enables the Macintosh to use software written for the IBM PC. MacCharlie permits Macintosh users to access the large library of IBM PC-compatible software, to connect to IBM serial networks, to exchange PC and Macintosh data files, and to use IBM peripheral devices such as letter-quality printers. It also serves as a printer buffer to the Macintosh.

MacCharlie functions as a coprocessing device. It consists of two primary components: a keyboard extension that contains ten function keys on the left side and a numeric keypad with 18 keys on the right; and an expansion unit that physically connects to the right side of the Mac, which contains the electronics and the disk drive(s). In the Macintosh mode, the 18 keys function as a normal Macintosh numeric keypad. In the PC mode, they function as a numeric entry pad.

The unit comes with a single 5¼-inch, double-sided, double-density disk drive with 360K of storage and 256K of random-access memory. Also available is an expanded version, MacCharlie Plus, with 640K RAM and two disk drives. (List Price: 256K version, \$1195; 640K version, \$1895)

Requires: Macintosh
Dayna Communications
50 South Main Street
Suite 530
Salt Lake City, UT 84144
(801) 531-0600

CIRCLE READER SERVICE NO. 540

II
SERIES

► PRAIRIE POWER SYSTEM

The Prairie Power system provides Apple IIc owners with a portable power system. The product's battery system features a rechargeable 12-volt battery that offers up to eight hours of continuous power and a circuit that sounds an alarm when the power reserve is low, automatically disconnecting the computer to protect the battery from deep discharge. The Prairie system is also designed to prevent overcharging.

The complete Prairie Power system is packaged in a water-resistant briefcase that can hold the computer, screen, and a modem and includes the case, battery pack with its own case, charger, wall transformer, disk pouch, should-

The Prairie Power system provides up to eight hours of continuous power for the Apple IIc.



Quadram's ProDOS Clock/Calendar card for the Apple II enables users to set transmission rate, data format, parity, and other parameters by using the menu-driven configuration program.

Quadram's Multicore memory-expansion board provides both a serial and a parallel interface.

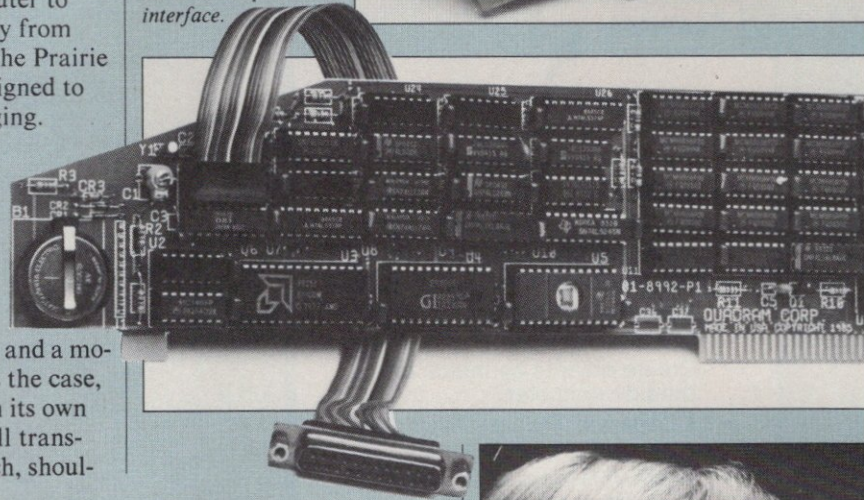
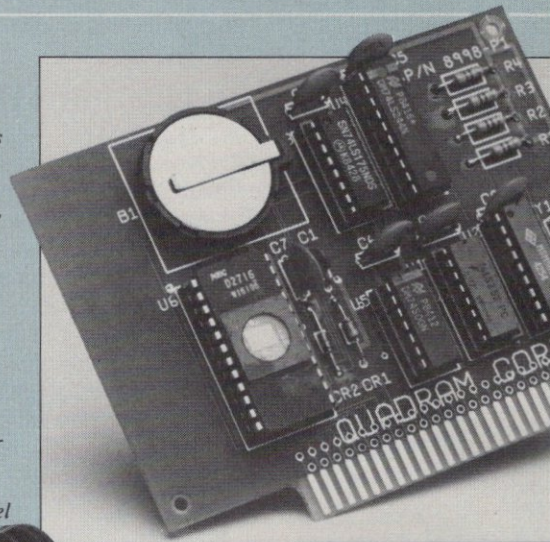

cables. (List Price: \$269.95)

Requires: Apple IIc
Prairie Power Systems, Inc.
768 Twelve Oaks Center
15500 Wayzata Blvd.
Wayzata, MN 55391
(612) 475-1793

CIRCLE READER SERVICE NO. 541

MacCharlie, from Dayna Communications

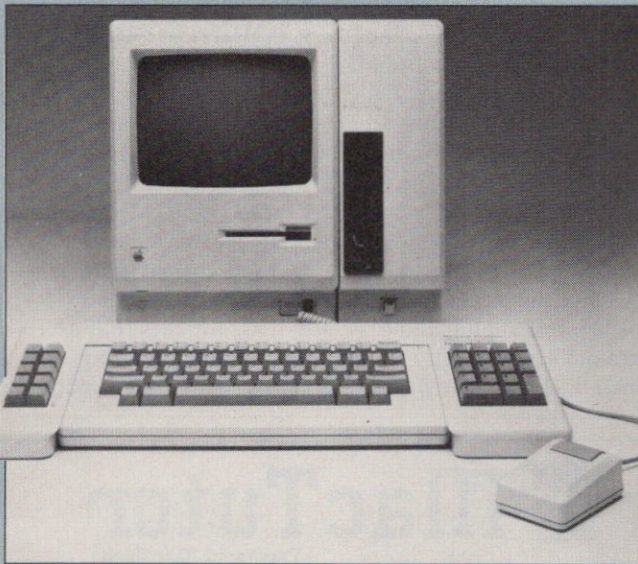

Touch Window, a touch-sensitive input device, can also work as a graphics tablet (see next page).

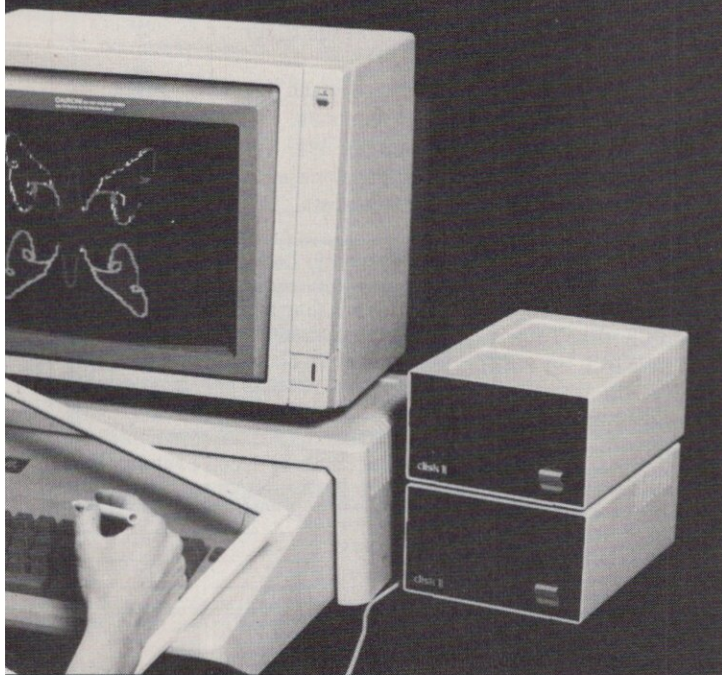

VISION 2000 DRAFTING SYSTEM

The VISION 2000 Designer System, a 2-D drafting system for Apple computers, consists of a graphics touch tablet and a full-fea-

ed design) software package that has automatic dimensioning capabilities. The touch tablet enables users to select commands from the menu screen and position the drawing cursor, and a pop-up numeric keypad eases numeric input. The system's features include multiple metric and English database units in fractions or decimals; 256 registered overlays; floating-point database structure; Cartesian, radial, relative, and local coordinate systems; and an easy-to-learn English command set.

Also available is a small, three-color robotic pen plotter that has a 1-meter umbilical cable, enabling it to work with a variety of paper sizes up to 24 x 36 inches. (List Price: Designer System, \$495; robotic pen plotter, \$395)

Requires: Apple II, IIe, or IIc; 128K RAM; 80-column card or RAMcard; two disk drives; monitor
Zericon Corporation
1100 South Main Street
Racine, WI 53403
(414) 633-7381

CIRCLE READER SERVICE NO. 542

The optional robotic pen plotter for use with Zericon's VISION 2000 2-D drafting system.

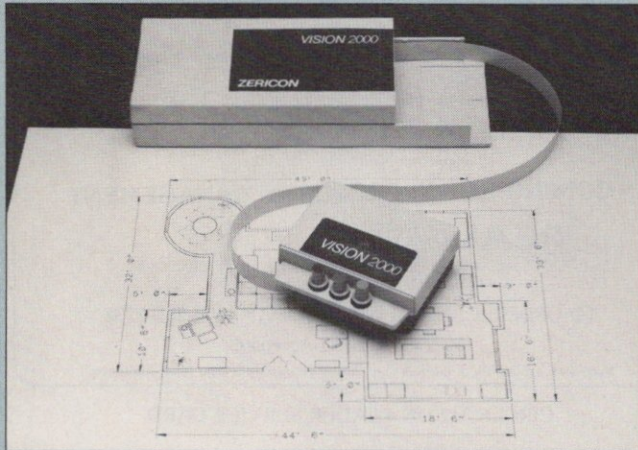

QUADRAM ENHANCEMENT BOARDS

Quadram Corporation has introduced five new enhancement boards for Apple II computers.

Multicore is a multi-function, memory-expansion board that provides both a parallel and a serial interface. The board has a ProDOS-compatible clock/calendar for time- and date-stamping files, and its switchless setup lets users set transmission rate, data format, parity, and other parameters by using a menu-driven configuration program.

Designed for the Apple IIe, the Extended Multi-function Card extends the computer's on-screen display to 80 columns. This card is also equipped with a ProDOS clock/calendar and comes in a 64K configuration. A model that provides an RGB interface is also available.

The Serial Interface Adapter operates either Apple's Super Serial Card or Quadram's serial APIC C/G card. It provides

graphics support for Imagewriter and Scribe printers, permitting double-high-resolution and color printing. Users can select settings by using the supplied menu-driven software, and all settings are stored in nonvolatile memory.

As does Multicore and the Serial Interface Adapter, the new Buffered Serial Printer Adapter features switchless settings and a supplied configuration program. The board is designed to provide ROM-based graphics support for double-hi-res and color printing with Imagewriter and Scribe printers and has a 64K print spooler that is expandable to 256K.

The fifth product, the

ProDOS Clock/Calendar, lets users time- and date-stamp files and comes with a long-life lithium battery and time- and date-setting software. (List Price: *Multicore*, \$219 for 0K, \$279 for 64K, \$329 for 128K, \$399 for 256K; *Extended Multifunction Card*, \$299—\$275 for RGB; *Serial Interface Adapter*, \$99; *Buffered Serial Printer Adapter*, \$139 for 64K, \$199 for 128K, \$259 for 256K; *ProDOS Clock/Calendar*, \$79)

Requires: Apple II, II Plus, or IIe

Quadram Corporation
4355 International Blvd.
Norcross, GA 30093
(404) 923-6666

CIRCLE READER SERVICE NO. 543

▶ HARDWARE



▶ A-MAX FOR THE II

The Mockingboard Division of Sweet Micro Systems has introduced the A-Max (short for Audio Maximizer), a self-contained pair of three-inch speakers with an earphone jack and individual amplifiers for each speaker. Owners of Mockingboards A or C can plug them into the two RCA plugs on the back of A-Max and take advantage of its remote volume controls and earphone jack. A-Max connects to the Apple's internal plug and a ground screw and is easy to install. (List Price: \$49.95)

Requires: Apple II, II Plus, or IIe

Sweet Micro Systems
50 Freeway Drive
Cranston, RI 02920
(800) 341-8001
(401) 461-0530

CIRCLE READER SERVICE NO. 544



▶ TOUCH WINDOW

Personal Touch has released Touch Window, a touch-screen input device that mounts directly on the screen of a monitor or TV that has a 10-15-inch diagonal. The device has a transparent, pressure-sensitive surface area of 8½ × 11 inches that users can touch with a finger or stylus to interact directly

AVAILABLE
NOW FOR JAZZ™

REAL ESTATE INVESTORS DEVELOPERS - CPA's

SERIOUS BUSINESS SOFTWARE FOR YOUR MACINTOSH™
from REALDATA

TAX SHELTER SYNDICATION ANALYSIS - Cash flow projections and allocations for real estate limited partnerships. INCLUDES NEW DEPRECIATION RULES.
By Irwin Nestler \$295

ON SCHEDULE - Economic project planning for subdivision and condominium developers and lenders. This month-by-month timetable helps you analyze and schedule all cash inflow and outflow. By Irwin Nestler \$195

REAL ESTATE OVERLAYS '84 - Sophisticated analysis of investment property. Our most popular program includes an extensive cash flow/sensitivity model, now with 1984 TAX REFORM ACT RULES. \$150

FINANCIAL OVERLAYS - Personal financial statement, critical ratio analysis, lease vs. buy, and more. \$100

COMMERCIAL/INDUSTRIAL APPLICATIONS - Detailed project cost analysis, multi-unit-income-and-expense schedule, and lease-tracking model. \$100

RESIDENTIAL MODELS - Market analysis by linear regression, mortgage qualifier, and rent vs. buy analysis. \$100

Minimum shipping charge \$5 - CT residents add 7.5% sales tax

READY TO RUN - EASY TO USE

Requires Multiplan™ or Jazz™

COMING SOON: PROPERTY MANAGEMENT

REALDATA

Software for Real Estate and Financial Professionals
78 North Main St., South Norwalk, CT 06854

TO ORDER, CALL OR WRITE TODAY 203-255-2732

MC/VISA/COD Accepted

Multiplan is a trademark of Microsoft Corp. Jazz is a trademark of Lotus Development Corp.

CIRCLE 342 ON READER SERVICE CARD



MacTutor™

(Formerly MacTech)

Vol. 1 No. 4

The Macintosh Programming Journal

March 1985

AT LAST!

A no-nonsense, no fluff Journal devoted to programming FOR the Mac, ON the Mac!

Let MacTutor's™ editorial board teach you the Macintosh technology of windows, quickdraw, events, and resources. We have assembled a team of professionals to uncover and explain Mac's secrets.

6 YEARS OF
EXPERIENCE IN
PC COMPUTER
EDUCATION!



YOUR SYMBOL
OF EXCELLENCE!

CHECK OUT OUR
PROGRAMMING
STAFF AND SIGN
UP FOR MacTutor™
DELIVERED TO YOUR
HOME OR OFFICE
EVERY MONTH!

Assembly Lab by David Smith

C Workshop by Bob Denny

Pascal by Chris Derossi

MacBasic by Dave Kelly

MacForth by Joerg Langowski

YES! I want to program my Macintosh! Send me a one year subscription.

I enclose \$24 US or \$36 Overseas.

MacTutor™
P.O. Box 846
Placentia, CA 92670

NAME:

ADDRESS:

CITY, ST, Zip:

PHONE: ()

© MacTutor™ FOR MORE INFO, CALL: (714) 993-9939 - ASK FOR LAURA

CIRCLE 348 ON READER SERVICE CARD

How did Hayes help Borg-Warner/Plastics break the mold in customer communications?

Charles Hostetter,
Marketing Manager,
Borg-Warner Chemicals, Inc.

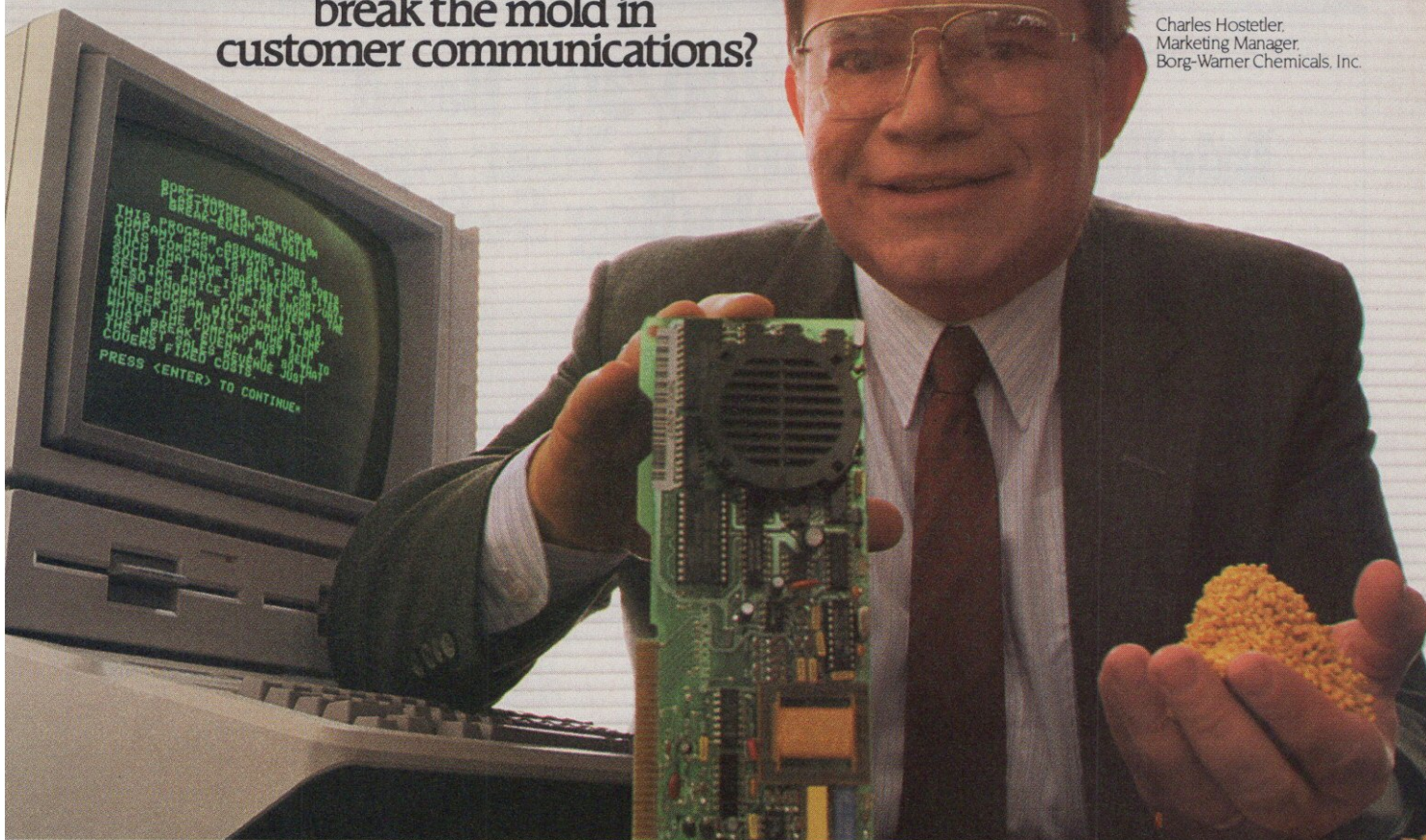

Borg-Warner chose Hayes Micromodem IIe[®] and Smartcom I[™] software. For quick, computer to computer communications with key customers.

To build a competitive edge in the plastics market, the dynamic management team at Borg-Warner found an innovative way to strengthen customer relations.

Now customers with Apple[®] IIe computer systems can communicate with the personal computers at Borg-Warner's headquarters through PlastivisionSM, a special on-line data base.

And Hayes Micromodem IIe plug-in board modems and Smartcom I software provide the critical communications link.

With their Hayes modems, customers can get immediate, accurate quotes based on detailed specifications. They can access entire catalogs of up-to-date technical information and industry news. And they have 24-hour-a-day troubleshooting assistance via computer.

Borg-Warner initiated Plastivision as a unique customer service. But now Hayes modems and software have helped streamline communications throughout the entire company.

And why did Borg-Warner choose Hayes?

"Because of their proven reliability," according to Charles Hostetter, Marketing Manager. Hayes is the acknowledged leader in modems and communications software for personal computers.

So whether your company uses Apple (any model), IBM[®] PC's or IBM compatibles, Hayes modems and software can improve the speed and accuracy of your communications.

Increase productivity. And help mold a new competitive edge for your business.

See your authorized Hayes dealer for a hands-on demonstration of Hayes modems and software. Today.

**New lower prices!
Act now!**
Micromodem IIe/Smartcom I
(for Apple II, IIe, II Plus and III)
\$199 sugg. retail
Smartmodem 300SM /
Smartcom I (for Apple IIIc)
\$239 sugg. retail



Hayes[®]

Innovative products
for enterprising people

Hayes Microcomputer Products, Inc., P.O. Box 105203, Atlanta, Georgia 30348 404/441-1617

© 1985 Hayes Microcomputer Products, Inc.

CIRCLE 217 ON READER SERVICE CARD

The Apple II... **HOT-LINE**

A Plug-In 1200/300 Baud Intelligent Modem For Your Apple II... Just \$449 Including Software

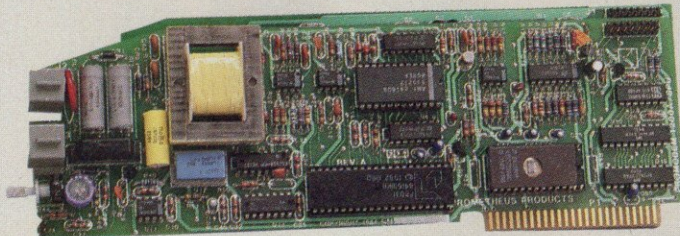

ProModem 1200A is a 1200/300 baud Hayes compatible auto-dial modem card that plugs directly into any expansion slot in the Apple II, II+, or IIe. All you have to do is plug it in and connect the telephone cord.

Ours is the only 1200 baud modem to seriously consider for your Apple II. At just \$449, it's priced well below its nearest competitor, yet it does much more. No longer do you have to buy an external modem, a serial card, an RS232C cable and communications software which, combined, would cost you hundreds of dollars more. There's really no comparison.

ProModem 1200A is the best modem, too. The internal software in its on-board ROM consists of a powerful menu driven terminal program. There is no need for a separate software disk. After a few keystrokes you'll be on-line and communicating.

Features include: Auto-dial/Auto-answer, tone and pulse dial, help commands, built-in diagnostics, two phone jacks, line status detect with redial on busy, full and half duplex and speaker with volume control.

You just can't lose when our plug-in ProModem 1200A comes ready to use, with on-board software, easy to understand documentation and a telephone cord — all for just \$449.

A Powerful Menu-Driven Terminal Program

<input type="radio"/>	1200A TERMINAL DRIVER
<input type="radio"/>	© PROMETHEUS PRODUCTS INC.
<input type="radio"/>	1) COMMUNICATIONS
<input type="radio"/>	2) FILE TRANSFER
<input type="radio"/>	3) OPTIONS
<input type="radio"/>	USE ESC TO EXIT
<input type="radio"/>	ENTER SELECTION
<input type="radio"/>	1) BAUD RATE 1200 300
<input type="radio"/>	2) DATA BITS 8 7
<input type="radio"/>	3) PARITY NONE ODD EVEN MARK SPACE
<input type="radio"/>	USE ESC TO EXIT
<input type="radio"/>	ENTER SELECTION
<input type="radio"/>	1) TYPE XMODEM LINE
<input type="radio"/>	2) DIRECTION SEND RECEIVE
<input type="radio"/>	3) FILE NAME
<input type="radio"/>	USE ESC TO EXIT
<input type="radio"/>	ENTER SELECTION
<input type="radio"/>	1) PRINTER ON OFF
<input type="radio"/>	2) CLOCK ON OFF
<input type="radio"/>	3) STATUS LINE ON OFF
<input type="radio"/>	4) KEYBOARD ON OFF
<input type="radio"/>	5) CAP LOCK ON OFF
<input type="radio"/>	6) ECHO ON OFF
<input type="radio"/>	7) LF AFTER CR ON OFF
<input type="radio"/>	USE ESC TO EXIT
<input type="radio"/>	ENTER SELECTION



The Hot Line

PROMETHEUS
PRODUCTS INCORPORATED

4545 Cushing Pkwy. • Fremont CA 94538

Call Now For
Complete Info...
415/490-2370

CIRCLE 122 ON READER SERVICE CARD

with their computers. Users can also remove Touch Window from the display and use it as a graphics tablet, as an input pad, or as an Interactive Book pad for use with Personal Touch's Touch Action books. The product comes with an Interactive Book, a WindowWare disk, mounting tabs, and a manual. (List Price: \$199.95; plug adapter for II or II Plus, \$7.50)

Requires: Apple II, II Plus, IIe, or IIc; plug adapter for II or II Plus
 Personal Touch Corporation
 4320 Stevens Creek Blvd.
 Suite 290
 San Jose, CA 95129
 (408) 246-8822

CIRCLE READER SERVICE NO. 545

II SERIES
MULTIRAM IIe EXPANSION CARD

The MultiRam IIe is expandable from 64K to 768K, using 64K and/or 256K RAM chips. A 768K extension card attaches to the MultiRam and offers RGB video, as well as expanding the MultiRam IIe to a full 1.5 megabytes of RAM. MultiRam C for the Apple IIc is available in 256K and 512K versions.

Each MultiRam card also includes an AppleWorks desktop space-expansion program at no extra cost.

Exclusive to MultiRam IIe is a built-in 16-bit microprocessor port that permits direct linear memory addressing—up to the full 1.5 megabytes—by processors from the 8086, 68000, and 65816 processor families. With the 16-bit coprocessor card for the 65816 soon to be available

from Com Log Company in Scottsdale, Arizona, the Apple IIe will approach the memory and processing capacity of a supermicro or minicomputer. (List Price: MultiRam IIe, from 64K at \$139.95 to 768K at \$549.95; MultiRam C, 256K—\$329.95, and 512K—\$495.95)

Requires: Apple IIe or IIc
 Checkmate Technology, Inc.
 509 South Rockford Drive
 Tempe, Arizona
 85281-3021
 (602) 966-5802

CIRCLE READER SERVICE NO. 546

II SERIES
MAC
MOUSETRACER DRAWING AID

Mousetracer is a drafting/drawing aid that includes a specially designed mouse holder. Users can trace hard-copy graphics and artwork onto the computer screen when using a mouse-controlled graphics program.

Mousetracer is fully assembled and includes an instruction manual with 20 copyright-free drawings. (List Price: \$34.95)

Requires: Apple IIe, IIc, or Macintosh
 Brimark Innovations
 9821 Yolanda Avenue
 Northridge, CA 91324
 (818) 885-8660

CIRCLE READER SERVICE NO. 547

II SERIES
STREET ELECTRONICS PERIPHERALS

Three new products for Apple computers are now available from Street Electronics. Designed for the Apple IIe are the BusinessCard, which includes two serial interfaces and a

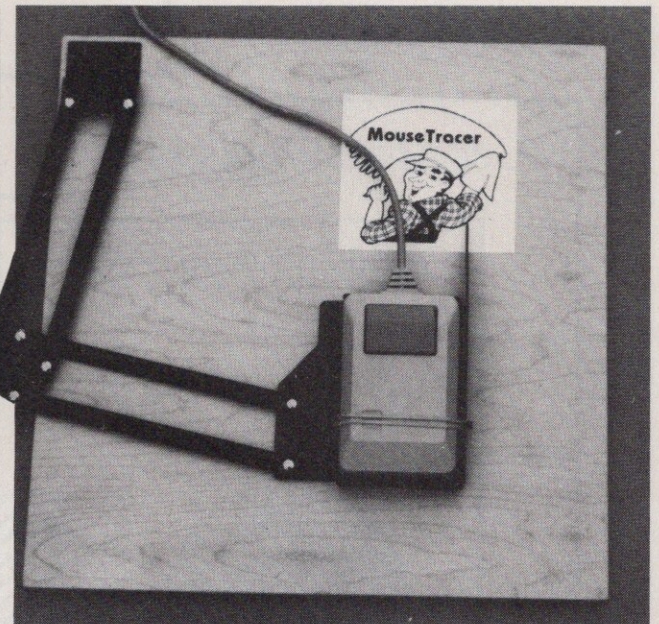

Mousetracer, a drafting/drawing aid for the Macintosh and the II series.

clock/calendar with battery backup, and the AlphaBits II, which has one serial printer/modem interface.

Both cards also feature more than 60 high-resolution graphics and text-printing commands that users can select from Macintosh-like pull-down menus. The cards can operate serial-interface printers or 300- or 1200-bps modems. A version of the BusinessCard for parallel-interface printers is also available.

The third product, designed for the Apple IIc, is the LiveWire, an intelligent converter cable that connects a parallel-interface printer to the IIc's serial port. The LiveWire also features a full-function clock/calendar with battery backup. The clock is built into the connector and allows users to time- and date-stamp ProDOS files. The LiveWire is available in both serial and parallel versions. (List Price: Busi-

nessCard, \$200; AlphaBits II, LiveWire, \$99.95)

Requires: Apple IIe or IIc
 Street Electronics
 1140 Mark Avenue
 Carpinteria, CA 93013
 (803) 684-4593

CIRCLE READER SERVICE NO. 548

II SERIES
COMPUTABILITY PRODUCTS

ComputAbility, a company specializing in hardware and software for people with special needs, has introduced two new products for the physically disabled. The Adaptive Firmware Card enables users to add one of 15 scanning techniques to commercially available software. The card also features one- or two-switch use; an assisted keyboard mode that adds locking Shift, Control, and Repeat functions; and the ability to alter the speed of interactive programs.

Designed for use with the card, the Unicorn Ex-

TM

GraphWorks

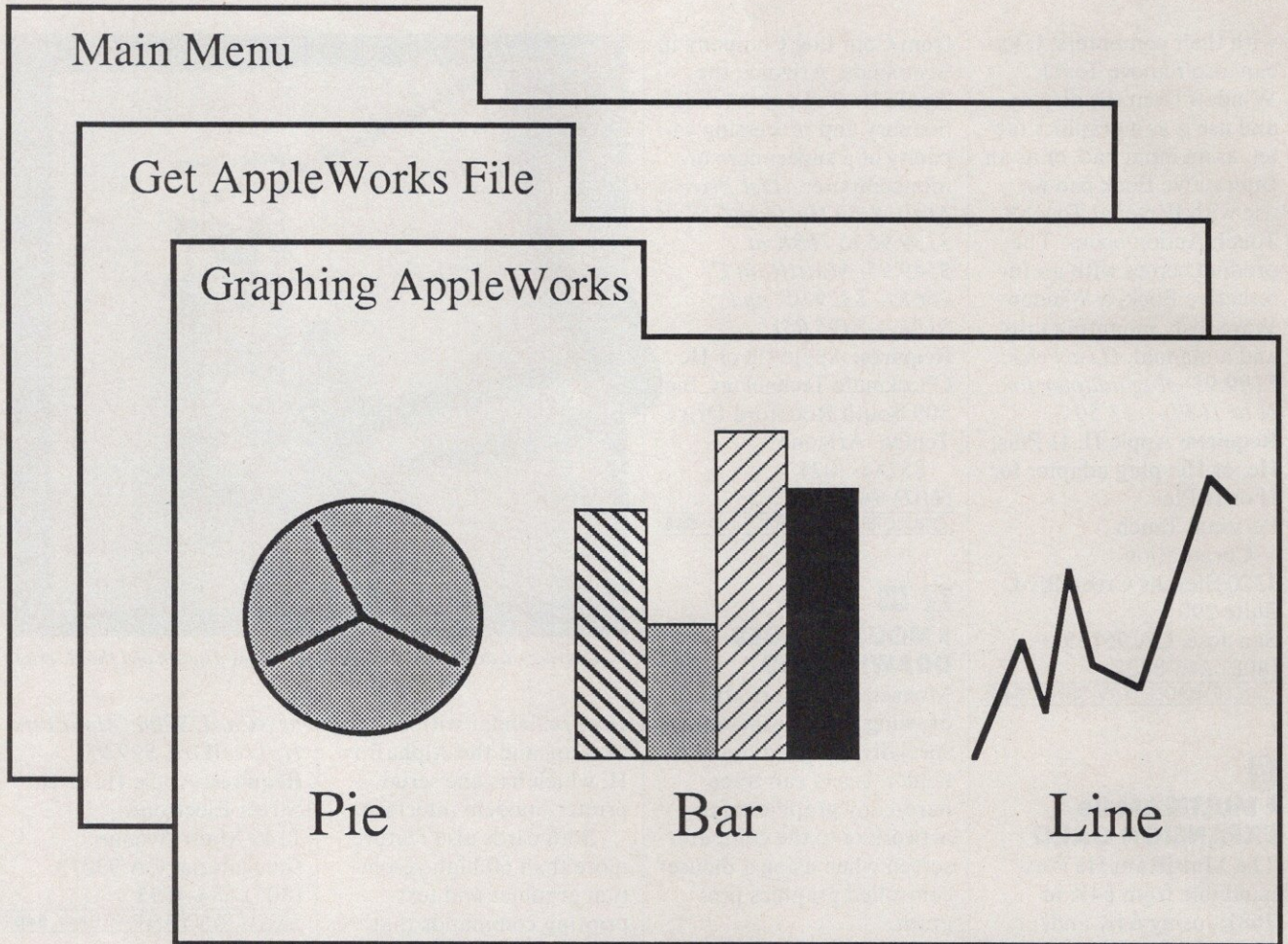

TM

Put AppleWorks to Work!!!

TM

GraphWorks adds graphics to AppleWorks

Visualize data. Print it. Present it.

GraphWorks

List Price

\$79.95

To Order



Five stars for your Apple.

Introducing a selection of new product stars for your Apple Computer from PBI Software.

Add a star and watch your Apple shine!

for the IIe/IIc™ SPECIAL PRICING

Add a parallel printer to your IIc

Here's a low cost serial to parallel adapter that comes complete with everything you need to connect your Apple's serial printer port to a standard parallel printer. This unit also allows you to print Epson Graphics. Please specify printer type. A Serial Box for the Macintosh™ will soon be available. Call for details.

Serial Box for the IIc ~~\$89.95~~
\$69.95

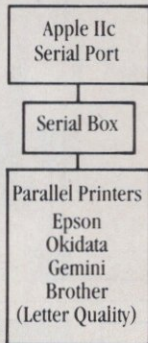

★ Serial Box

for the Macintosh™



Personalize Your Macintosh™ icons!

Icon Switcher allows you to design your own icons with MacPaint™ and replace your program icon with one of your own creations, all in a few simple steps. Identify your special files quickly!

Icon Switcher for Macintosh \$19.99

★ Icon Switcher

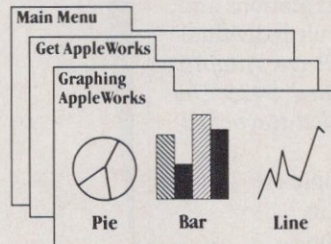

GraphWorks adds graphics to AppleWorks™

Visualize data. Print it. Present it. Now you can plot spreadsheet data files as line, bar, stack-bar or pie charts. The program is menu-driven and folder-oriented, so it's as easy to use as AppleWorks!

GraphWorks for the IIe/IIc \$79.95

★ GraphWorks™

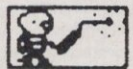

The game for the Macintosh™

Feathers & Space is an arcade-like game that takes full advantage of the graphics and sounds of the Macintosh. Attacking birds stress the defense capabilities of your mother ship and the space outpost. Protect the space outpost or get eaten alive. Mouse ship movements, click activated firing power and keyboard smart bombs. This game also offers defense from discovery; one click and your boss can't walk in and smart bomb you if you're defending your outpost at work.

Feathers & Space for Macintosh \$34.95

★ Feathers & Space™

PBI Software
A SUBSIDIARY OF ITAT, INC.

1155B-H Chess Drive • Foster City, CA 94404
CIRCLE 140 ON READER SERVICE CARD

To Order:

Call Toll Free: 800-843-5722
In California: 800-572-2746
VISA, MasterCard and American Express accepted.
Monday thru Friday 9AM-5PM PST
Information & Dealer inquiries, call: 415-349-8765

Apple IIc, IIe, AppleWorks and MacPaint are trademarks of Apple Computer, Inc. Macintosh is a trademark licensed to Apple Computer, Inc. GraphWorks and Feathers & Space are trademarks of PBI Software.

panded Keyboard is a lightweight flat panel that has 128 large touch-sensitive keys, any of which can be grouped to appear and function as a single, larger key.

The company also offers a service, The Handicapped's Source, that develops and sells specialized hardware adaptations and software to suit individual needs. (List Price: Adaptive Firmware Card, \$425; Unicorn Expanded Keyboard, \$375)

Requires: Apple IIe ComputAbility Corporation
101 Route 46 East
Pine Brook, NJ 07058
(201) 882-0171

CIRCLE READER SERVICE NO. 549



MOUSETRACE

You can use the pictures you create with MouseTrace (working from drawings, pictures in books or magazines, maps, diagrams, or charts) in a

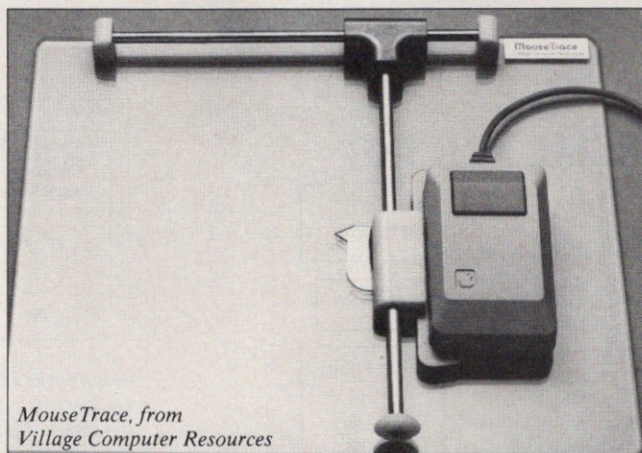

MouseTrace, from Village Computer Resources

graphics program such as MacPaint or MousePaint. The MouseTrace board is made of abrasion-resistant acrylic, and the clear board gives you a flat working surface even if you are tracing from a book. Stainless-steel

rods give durability, and linear ball bushings give smooth operation. (List Price: \$89)

Requires: Apple IIe, IIc, or Macintosh Village Computer Resources
P.O. Box 155
Lakewood, CA 90714
(213) 421-3412
(800) 321-3500 (orders only)

CIRCLE READER SERVICE NO. 550

HARDWARE / SOFTWARE



MEMONCON CRAWLER ROBOT

You can program the Memoncon Crawler robot to go

HIPPO-C™

The C compilers for the Macintosh™

Level 1:

The ideal C compiler: powerful, expandable, affordable.

- A friendly, integrated environment complete with a screen editor, full K&R C compiler, linker, source-level debugger, tutorial, standard C library, and structure definition files.
- Convenient access to over 400 Toolbox routines, serial ports and sound channels.
- Over 200 pages of documentation and many sample programs.
- Upgradable to Hippo-C Level 2 for \$250.00 suggested retail price.
- New version 1.2.
- \$149.95 suggested retail price.

Level 2:

At last: a complete professional C compiler!

- Allows for the creation of large, stand-alone commercial applications.
- Comes with a screen editor, optimizing K&R C compiler, 68000 assembler, linker, C library, stdio package, full floating-point support, and structure definition files.
- "Glue" routines which allow easy access to Macintosh features.
- UNIX™-like shell which includes many powerful commands and utilities.
- Convenient access to over 500 Toolbox routines.
- Documentation, many sample programs, and sources.
- No royalties or license fees.
- You may obtain a non-copy protected disk by signing and returning a form along with \$25.00 to Hippopotamus.
- \$399.95 suggested retail price.

HIPPOTAMUS™
SOFTWARE, INC.

985 University Avenue, Suite 12, Los Gatos, California 95030 • 408/395-3190 • Telex: 172211 HQSUVL

Available from your local dealer or directly from Hippopotamus Software

Dealer inquiries welcome. We accept credit cards, checks, and money orders. California residents add local sales tax. Please include \$10 for shipping and handling. Macintosh is a trademark of Apple Computer, Inc. UNIX is a trademark of AT&T Bell Labs. Hippo-C is a trademark of Hippopotamus Software, Inc. Please allow 3-4 weeks for delivery. Price, availability, and specifications subject to change without notice.

CIRCLE 197 ON READER SERVICE CARD

kyan
PASCAL
For the Apple

kyan pascal is the most complete package available for learning and using the Pascal language. And now, it's available for the Apple II family of computers.

kyan pascal is easy to use, lightning fast, and loaded with features. It's a full Pascal implementation. It compiles and runs many times faster than other Pascal compilers.

kyan pascal features:

- Optimized Machine Code Compiler.
- Built-In Full Screen Text Editor.
- String-Handling, Chaining, Include File, and Other Powerful Extensions.
- Random Access Files and Full Graphics Support.
- Built-In Assembler (Allows Full Hardware Control).
- 13-Digit Arithmetic Precision, and.
- Tutorial Manual with Sample Programs.

kyan pascal requires 64K of memory and a single disk drive. No additional hardware is necessary. And, it comes with kyan's MONEY BACK GUARANTEE... If not completely satisfied, return it within 15 days for a full refund.

kyan pascal for the Apple \$69.95

(Add \$4.50/copy for handling; \$12.00 outside North America. California residents add \$4.55/copy for sales tax)

Send Check/Money Order to: **kyan software**, Dept K
Call: (415) 775-2923 1850 Union St., Ste. 183
MC/Visa Accepted San Francisco, CA 94123

CIRCLE 161 ON READER SERVICE CARD

NORTHEASTERN SOFTWARE

88 Ryders Lane, Stratford, Connecticut 06497

- Up to 50% off • New larger facilities
- School & corporate purchase orders accepted
- For items not listed please call
- We ship Federal Express — call for details

Advanced Ideas	
Lucky's Magic Hat	25.00
Dinosaurs Dig	25.00
Advanced Logic Systems	
Mighty Mac	Call
American Training Int'l (ATI)	
MacCoach (Intro. to the Mac)	45.00
Ann Arbor Softworks	
Animation Tool Kit 1	30.00
Animation Tool Kit 1 (Adv. Ver.)	Call
Apple Computer	
Mac Project	Call
Mac Terminal	Call
Apropos	
Financial Planning	64.00
Investment Planning	64.00
Tax Planner	34.00
Artsci Magic File	59.00
Assimilations Process	
Lock-It	20.00
Mac Memory Disk	20.00
Mac Spell Right	60.00
Mac Tracks	20.00
Axlon	
Art Portfolio	35.00
Card Shoppe	35.00
Macmatch	31.00
Mouse Tracks	30.00
Typing Avalanche	36.00
Blue Chip	
Baron	36.00
Millionaire	36.00
Tycoon	36.00
Boston Software	
MacPublisher	78.00
Brainworks	
Chipwits	30.00
Thinkfast	24.00
Brock Software	
Keystroke Database	274.00
Broderbund	
Cyborg	25.00
Lode Runner	25.00
Casady Company	
Fluent Fonts	Call
CBS Murder by the Dozen	28.00
Central Point Mac Tools	22.00
Continental/Arrays	
The Home Accountant	57.00
Creative Solutions	
MacForth Level 1	89.00
MacForth Level 2	139.00
Creighton Development, Inc.	
Home Pak	24.00
MacOffice	24.00
MacSpell+	60.00
CSD, Inc. MacLion	Call
DataPak Software	
MacJack	27.00
MacPoker	27.00
MacSlots	48.00
Desktop Software 1st Base	108.00

Dow Jones	
Market Manager Plus	119.00
Spreadsheet Link	60.00
Straight Talk	48.00
Electronic Arts	
Financial Cookbook	27.00
Pinball Construction Set	27.00
EnterSet Quick Set	Call
Esoft Enterprises	
ColorPrint Software	Call
ColorPrint Starter Kit	Call
Expertelligence Experlogo	80.00
Forethought	
Factfinder	89.00
Typing Intrigue	30.00
General Computer Co.	
Ground Zero	24.00
Haba Systems	
Haba Checkminder	Call
Haba Com	Call
Habadex	50.00
Haba Window Dialer	Call
Harvard Associates	
Desktoppers	30.00
MacManager	31.00
Hayden Software	
Davinci Building Blocks	49.00
Davinci Commercial Interiors	118.00
Davinci Houses	30.00
Davinci Interiors	30.00
Davinci Landscapes	30.00
Ensemble	178.00
Hayden Base	92.00
Hayden Speller	47.00
I Know It's Here Somewhere	28.00
Master Pieces	24.00
Music Works	47.00
Sargon III	30.00
Word Challenge	25.00
Henderson Associates	
Real Poker	25.00
Hippopotamus Hippo-C	117.00
Human Edge	
Communication Edge	115.00
Management Edge	145.00
Mind Prober	31.00
Negotiation Edge	170.00
Sales Edge	145.00
Ideaforn MacLabeler	36.00
Industrial Computations	
MacPuzzle	29.00
Infocom	
Cutthroats	25.00
Deadline	31.00
Enchanter	25.00
Hitchhiker's Guide to the Galaxy	25.00
Infidel	28.00
Planetfall	24.00
Seastalker	25.00
Sorcerer	28.00
Starcross	31.00
Suspect	28.00

Suspended	28.00
Witness	25.00
Zork I	25.00
Zork II	25.00
Zork III	28.00
Intelligent Statements	
Professional Blackjack	47.00
Trivia Arcade	23.00
Intermatrix Chequebook	46.00
Kensington Microware LTD	
Professional Type Fonts	60.00
Layered Inc. Front Desk	89.00
Living Video Text	
Think Tank - 128K	75.00
Think Tank - 512K	145.00
Lotus Jazz	Call
Macadam Publishing	
Windoware Calendar	33.00
Windoware Phonebook	33.00
Magnum	
McPic I	30.50
McPic II	30.50
The Slide Show	37.00
Mainstreet	
Main Street Filer	114.00
Main Street Writer	125.00
Mainstay Macasm	75.00
Manhattan Graphics	
Ready Set Go	Call
Mark of the Unicorn	
Mouse Stampede	23.00
Matrix Associates Images	28.00
MegaHaus	
Megafiler	114.00
Megaform	177.00
MegaDesk	75.00
MegaMerge	74.00
Micro Analyst Mac Zap	49.00
Microsoft	
Business Pack	357.00
File	115.00
Mac Basic Interpreter	89.00
Microsoft Chart	74.00
Microsoft Multiplan	115.00
Microsoft Word	115.00
Miles	
Mac Attack	29.00
Mac the Knife	23.00
Mac the Knife II	29.00
Mirage Trivia	29.00
Monogram	
Dollars & Sense	82.00
Forecast	42.00
NewSoft NewGammon	Call
Odesta Helix	240.00
Organizational Software	
Omnis 2	164.00
Omnis 3	215.00
PCA Software MacSmith	42.00
Peachtree	
Back to Basics	215.00
GL/AR/AP	ea. 95.00

Penguin	
Graphics Magician	29.00
Pensate	24.00
Quest	24.00
The Coveted Mirror	24.00
Transylvania	24.00
Xyphus	24.00
Planitir MacType	31.00
Professional Software	
Trivia Fever	24.00
Protek-It Software	
Pro Copy	Call
ProVue Development	
Overvue	174.00
Priority Software	
Forbidden Quest	27.00
Gateway	27.00
Real Data Inc.	
Commercial Real Estate Dev.	75.00
General Financial Analysis	75.00
Residential Real Estate	75.00
Reston Publishing	
Construction Estimator	49.00
Rio Grande Software	
Softmaker II	105.00
Scarborough	
Make Millions	29.00
Masterytype	29.00
Run for the Money	30.50
Sierra-OnLine Frogger	24.50
Simon & Schuster	
Typing Tutor III	31.00
Sir Tech Wizardry	35.00
Softech Microsystems	
Advanced Dev. Tool Kit	105.00
Fortran 77 Dev. Sys.	200.00
Fortran 77 Lang. Compiler	165.00
Mac Advantage: UCSD Pascal	200.00
Mail Manager	84.00
UCSD Pascal Dev. Sys.	135.00
UCSD Pascal Lang. Compiler	100.00
Softstyle Epstart	23.00
Softsync	
Personal Accountant	55.00
Software Arts	
TK Templates	35.00
TKI Solver	145.00
Software Publishing	
PFS: File	70.00
PFS: Report	70.00
PFS: File & Report	110.00
Softworks Limited	
Softworks C	275.00
Southeastern Software	
Mac Transfer	32.00
State of the Art	
Electric Checkbook	49.00
Stoneware DB Master Mac	115.00
T/Maker	
Click Art Personal Graphics	30.00
Click Art Publications	30.00
Click Art Letters	30.00
Telos	
File Vision	115.00
File Vision (Int'l.)	115.00
File Vision (UK)	115.00
Think Educational	
MacEdge	30.00
Mind Over Mac	30.00
Videx	
MacCalendar	53.00
MacCheckers and Reversi	28.00
MacFun Pak (4 Games)	24.00
MacGammon & Cribbage	28.00
MacVegas	34.00
Warner	
Desk Organizer Mac	61.00

Specials

Copy II Mac	22.00
Maxell Disks 3 1/2	34.00
Memorex Disks 3 1/2	33.00
Smooth Talker	95.00
Sony Disks 3 1/2	35.00
Tecmar Hard Disks	Call

Hardware/Accessories

Apple	
Image Writer 10" & 15"	Call
Mac External Drive	Call
Assimilations Process	
Mac Daisy Wheel Connection	74.00
Mac Epson Connection	69.00
Mac Turbo Touch	Call
CompuServe Starter Kit	23.00
Creighton Development, Inc.	
Proprint	48.00
Proprint w/8ft Serial Cable	69.00
Proprint w/2 Cables & A-B Switch	148.00
Curtis	
Diamond	35.00
Emerald	45.00
Sapphire	55.00
Ruby	65.00
Dilithium Press	
PC to Mac and Back	61.00
PC to Mac and Back w/Cables	88.00
Elephant	
Image Writer Ribbons	5.00
Epson	
RX 80+	199.00
RX 80ft+	Call
RX 100+	Call
FX 80+	Call
FX 100+	Call
LX 80+	Call
Hanzon	
Universal Interface for Epson Printers	65.00
Hayes	
Smartmodem 1200B	Call
Smartmodem 300B	Call
Innovative Concepts	
Flip 'n' File (20)	19.00
Intermatrix MacPhone	124.00
Iomega The Bernoulli Box	Call
Kensington Microware LTD	
Mac Control Center	68.00
Mac Disk Case	10.00
Mac Dust Cover	10.00
Mac Starter Pack	54.00
Mac Surge Protector	34.00
Mac Swivel	20.00
Portable Modem	95.00
Printer Stand	15.00
Koala Mac Vision	228.00
Microcom Mac Modem	399.00
Micron Technology Micron Eye	279.00
Microsoft Mac Enhancer	160.00
Novation	
Smartcat w/software	323.00
Okidata	
ML-92S MAC/LISA	Call
ML-93S MAC/LISA	Call
Prentice	
Popcom X-100 Modem	290.00
Prometheus	
Promodem 1200 w/software	365.00
Thunderware Thunderscan	Call
Toshiba Printers	Call

For Inquiries and Connecticut Orders Call (203) 375-3860

For Fast Delivery send cashier's check, certified check or money order. Personal and company check allow 3 weeks to clear. Shipping - Software (\$2.50 minimum). C.O.D. add an additional \$1.75. Shipping - Hardware (please call). Alaska, Hawaii, Canada, PO, APO and FPO \$5.00 minimum. Foreign orders - \$15.00 minimum and 15% of all orders over \$100. Mastercard & Visa (include card # and expiration date). Connecticut residents add 7.5% sales tax. We ship same day for most orders. Prices subject to change without notice. School purchase orders accepted. All returns must have a return authorization number. Call 203-375-3860 to obtain one before returning goods for replacement.



Orders Only • Toll Free

7 Days/Wk 9 a.m. to 9 p.m. EST

1-800-382-2242

forward, turn right or left, stop, sound its buzzer, and turn on its light. Using the programming feature, the operator can determine a course or set up a maze for the robot to negotiate. The brain of the Memoncon Crawler is an on-board static RAM (256 × 4 sequencer). It comes with a prewired and tested electronic circuit board and a 5-key teaching pendant with connecting cable.

Available, too, is a Programming Kit, which enables you to program the Memoncon through your computer instead of through the teaching pendant. You can write your own program, edit it, store it, and then load it into the Memoncon RAM. The Programming Kit includes an interface cable for use between the Memoncon Crawler and your computer, a software diskette, and instructions. (List Price: Robot Kit, \$74.95; Programming Kit, \$39.95) **Requires:** Apple II Plus or IIe

Buyus, Inc.
10 White Birch Drive
Ossining, NY 10562
(914) 762-4799

CIRCLE READER SERVICE NO. 552

► SOFTWARE

MAC

► 1STPORT DATA CONVERSION

A communication and data-conversion package, 1STPORT allows the Macintosh to function as an ASCII terminal for communicating with other micros, mainframes, and public databases. Users can send or receive both ASCII and binary data and thus can transfer programs and data files. 1STPORT can also convert data transferred to the Macintosh into several different data formats for use with a variety of Macintosh software, including DeskTop Software's 1STBASE relational-database program. The software has five options—1STBASE file, DIF file, SYLK file, fixed record-length text file, and the Clipboard. (List Price: \$95)

Requires: Macintosh, 128K or 512K RAM
DeskTop Software Corporation
CN-5287
Princeton, NJ 08540
(609) 924-7111

CIRCLE READER SERVICE NO. 553

MAC

► OMNITALK NETWORK SOFTWARE

To provide Macintosh users of Apple Computer's AppleTalk network with true shared access to its OmniDrive disk drives, Corvus Systems has introduced OmniTalk network software. OmniTalk is designed to work with the Apple Finder program and allows users to share application programs, as well as read and write safely to different controlled volumes on OmniDrive. The software also lets users divide the drives into private, public, and controlled volumes of varying sizes with three levels of password protection. (List Price: \$395)

Requires: Macintosh, AppleTalk, OmniDrive disk drive

Corvus Systems, Inc.
2100 Corvus Drive
San Jose, CA 95124
(408) 559-7000

CIRCLE READER SERVICE NO. 554

7
SERIES

► KYAN PASCAL

Designed for both beginning and advanced programmers, Kyan Pascal is a full implementation of Jensen/Wirth Pascal. For beginners the package has command menus, help screens, a comprehensive tutorial manual, and an extensive library of compiler error messages. In addition the Kyan Pascal software provides advanced programmers with a powerful ProDOS-based software-development system featuring a 6502 machine-code compiler, a full-screen text editor, full-pass error detection, enhanced sound and

graphics, a built-in assembler, random-access files, and powerful extensions to standard Pascal. (List Price: \$69.95)

Requires: Apple II Plus, IIe, or IIc; 64K RAM; one disk drive

Kyan Software
1850 Union Street
Suite 183
San Francisco, CA 94123
(415) 775-2923

CIRCLE READER SERVICE NO. 555

MAC

► MACCRACK PAK II

Bay Systems is now distributing FWB's MacCrack Pak II, a software-utility package for the Macintosh that allows users to back up copy-protected software so that they need not risk using the software's master disk. The product also enables users to upload many software packages from floppy to hard disks and RAMdisks. The package is geared to novice users and comes with step-by-step instructions. (List Price: \$79.95)

Requires: Macintosh or Macintosh XL

Bay Systems Company
1001½ Broadway
San Francisco, CA 94133
(415) 474-8055

CIRCLE READER SERVICE NO. 556

7
SERIES

► EDUCATIONAL WORD JUGGLER

An educational edition of the word-processing program Word Juggler, designed for grades 5 through 12, is now available. The educational edition has all the features of the business-level program, including replacement keycaps that label the principal editing

Memoncon Crawler Robot, from Buyus, Inc.

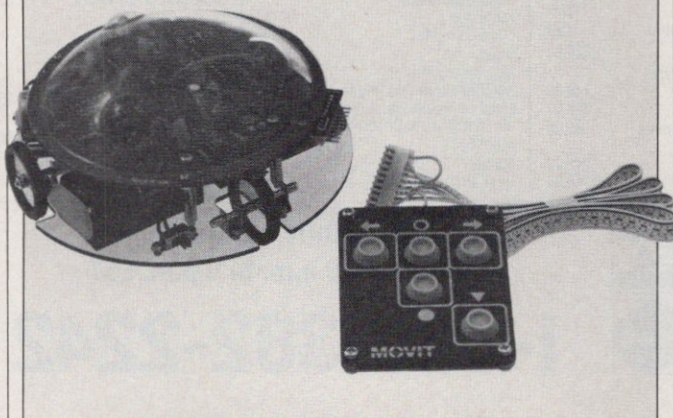

CRYSTALWARE

"TAKE YOUR MAC TO THE LIMIT...AND BEYOND!"

Crystal has been a leading producer and certified developer of Apple software since 1979. They produced the first graphic adventure for the Apple...House of Usher and the grandfather of all adventure games, the six-disk Fantasyland 2049 A.D. In 1981 John and Patty Bell and Mike Potter produced Protector which was a major hit in the arcade software market. Crystal currently has more than 65 titles available which run on a dozen micros.

The Mac has incredible graphics and memory. Some of our games take up as much as 1 million bytes, include dazzling graphics and sound, and will give your Macintosh a run for it's money. We also produce a fine line of business packages and graphics utilities.

WIZARD OF ZEN

A children's anthology with Tic-Tac-Toe, Hangman and Grumpus. It's a series of Fantasy Tales for bedtime reading and an educational graphic adventure called the Wizard of Zen where you go inside a computer to the Land of Zen. Also includes Mr. Key to help young users learn about the keyboard and how to use it.

Now Available! \$29.95/disk

GHOST MANSION

Enter the creepy old Ludwig estate with its hundreds of rooms, forests, garden path, a vast cemetery and crypt, and a host of vampires, werewolves and secret passages. Even compiled, this game takes up more than 320,000 bytes on disk. A challenge for even the most seasoned adventurer with a "save game" feature so that you may play this game in more than one sitting. In the development of this game, it took our Macintosh more than an hour to display all the castle and grounds, with each display generated in only a few seconds. We are offering a prize of \$100 for the first person to solve the mystery and send in their solution by certified mail! Now Available, also available for the Apple IIe & IIc!

\$49.95/disk

POOR JOHN'S ALMANAC

This is the first of our series of practical business application programs, inspired by requests of our Midwest users. It includes a wealth of information on agriculture, animal husbandry, and farming. It also has an inventory control package and more information on AGRINET, our online information service on current meat and grain prices. We have received enormous support already for this package but still could use a lot more information. If you are currently involved in this industry and would care to share your knowledge, we would be pleased to hear from you in writing or by phone.

Now Available! \$49.95/disk

ZARDON- JOURNEY TO THE CRYSTAL PLANET

Somewhere in another galaxy far, far away is the legendary Crystal Planet. It is a voyage of many centuries through the uncharted regions beyond the Galactic Frontier. Besides a clever captain you must also be a shrewd trader for it is impossible to take enough supplies for your quest so you must acquire goods and additional gold and silver along the way. This game is the forerunner of the later to be released Galactic Expedition. It contains incredible high speed graphics, a great deal of animation, and is unlike anything currently on the software market. Now Available!

\$49.95/disk

CRYELL - THE PATHFINDER

Imagine a fantastic voyage through the human body in a miniature submarine the size of a pin-head. Imagine being able to travel through the human circulatory system and battling amoebic antibodies with your onboard laser while piloting your ship through a fascinating 3-D animated color simulation. Picture if you will, another dimension of adventure in sight and sound and color. You have just begun to experience Cryell-the-Pathfinder. Now Available!

\$39.95/disk

GOPHER

Deep in the earth, lurking in a labyrinth of tunnels beneath Uncle John's garden, lives Henry the Gopher. As you tunnel through earth you must avoid falling rocks and set traps for the Veggie Bandit.

Now Available! \$29.95/disk

All products come with a lifetime guarantee / use the finest media / and are thoroughly tested. There are now more than 38 programmers working for Crystalware and we are always looking for more talented hackers. We pay royalty fees from 15% to 25% of the gross sales price.

* To place an order send check or money order to:
Bell Digital / Crystalware Corporation
5647 So. 6th St., Klamath Falls, Oregon 97603

Call toll-free in the US (800)-848-8088 or in Oregon call (503) 882-0024

- * If you are interested in more information, send \$3.00 and we will send you a copy of Crystal Vision, which includes detailed descriptions of our 65 products.
- * If you would like a demo with your catalog, send \$20.00 and you will receive a years subscription to Crystal Vision, a lifetime membership in the International Crystal Users Group, and of course a demo disk.

Our order lines are now open 24 hours/day, 7 days/week
(We now also accept VISA, MASTERCARD, and AMERICAN EXPRESS)



CIRCLE 213 ON READER SERVICE CARD

and formatting functions, and the Lexicheck spelling checker. In addition, the product includes a teacher's guide, a student handbook that contains 12 tutorial-style lessons, and a student activity disk. Purchases must include at least one teacher's edition and three student editions. (List Price: teacher's edition, \$189; student's edition, \$100)

Requires: Apple IIe or IIc Quark, Inc.
2525 West Evans
Suite 220
Denver, CO 80219
(800) 543-7711
(303) 934-2211

CIRCLE READER SERVICE NO. 557



► **QUARTET GRAPHICS /SPREADSHEET**

Haba Systems has released an integrated spreadsheet and graphics program, Quartet, for the Mac. The program can display spreadsheets, charts and graphs, and text windows simultaneously and also has database capabilities. The program can handle spreadsheets of up to 62 columns by 999 rows and includes all commonly used spreadsheet functions, as well as functions such as Date, Net Present Value, Internal Rate of Return, Future Value, Payment, Standard Deviation, and Variance. In addition, Quartet can create data tables that allow users to view results of complex "what if" scenarios. (List Price: \$199)

Requires: Macintosh Haba Systems, Inc.
15154 Stagg Street
Van Nuys, CA 91405-1025
(818) 989-5822

CIRCLE READER SERVICE NO. 558



► **FINANCIAL COOKBOOK**

Financial Cookbook, a program that helps users make personal financial decisions, is now available on disk for the Macintosh computer. The software contains 32 recipes, or formulas, that produce answers to questions about taxes, investments, savings, mortgages, the effects of inflation, and other financial issues. Calculations for 11 basic tax shelters are also included in the program. Financial Cookbook contains a tutorial, "recipe" instructions, and a 100-item index and comes with a manual that provides thorough explanations of financial and tax issues and a glossary of terms. (List Price: \$50)

Requires: Macintosh Electronic Arts
2755 Campus Drive
San Mateo, CA 94403
(415) 571-7171

CIRCLE READER SERVICE NO. 559



► **MACENGINEER-ELECTRICAL ENGINEERING**

Superex has released MacEngineer-Electrical Engineering, the first in a series of four engineering programs for the Macintosh. The software contains 30 formulas for the most frequently used engineering calculations. Users select the formula they wish to use and enter the variables, and the program then calculates and displays the result.

Superex is encouraging users to send it any important formulas that they feel should be included in the program. If the company uses any of the suggested

formulas in its next version of MacEngineer-Electrical Engineering, the customer will receive a \$25 U.S. Government Savings Bond for each formula and a free updated version of the program. (List Price: \$99.95)

Requires: Macintosh Superex Business Software
151 Ludlow Street
Yonkers, NY 10705
(800) 862-8800
in NY (914) 964-5200

CIRCLE READER SERVICE NO. 560



► **MACINTOSH MICROPLANNER**

In conjunction with Apple Computer, Micro Planning Software has developed Macintosh MicroPlanner, an easy-to-use, professional project-management software project. A demonstration package, which is refundable against the later purchase of the product, is also available. (List Price: \$395; demo package, \$25)

Requires: Macintosh Micro Planning Software USA
235 Montgomery Street
Suite 840
San Francisco, CA 94104
(415) 788-3324

CIRCLE READER SERVICE NO. 565



► **MACCOUNANT FOR BUSINESSES**

Designed for small-business use, Maccountant is an easy-to-use accounting program that offers the full range of accounting functions from General Ledger to Accounts Payable and Receivable. The program's management-planning aids include the ability to break financial statements out into 99 categories that allow users to analyze trends in sales, personnel, product lines, customers, and so on. Windowing and scrolling features enable users to work with many statements simultaneously.

The Maccountant program can handle a full year's data on one disk and can also produce detailed integrated reports with flexible reporting periods. A free demo disk is available. (List Price: \$195)

Requires: Macintosh, 128K or 512K RAM Digital, Etc.
1749 14th Street
Santa Monica, CA 90404
(800) 922-7500 or
(213) 452-5636;
in UT (800) 622-2500

CIRCLE READER SERVICE NO. 566

File Edit Functions Reports Month		Income Statement		Purchases/Accounts Payable	
Department Income		Balance Sheet		The Hardware House	
Trial Balance		Check Register		For the month of Nov, 1984	
Sales/Accounts Receivable		Daily Cash Report		Ref Account#	
The Hardware House		Account History		0235 6010	
For the month of Nov, 1984		General Ledger		2050/0200	
Date	Ref	Account#	Received From/Description	Ref	Account#
11/01	11624	1050/0100	Cash Sales - Nuts	7777	1103
		4010/01	TSI Paid Bill-Disc.	7777	2050/0300
		11625	TSI Took Discount		
		Green			
		4010/03			
		11625			
		2100			
Date	Net Amt of Deposit	Received From/Description	Ref	Account#	
11/01	100.00	Cash Sales - Nuts	\$\$\$	4010	
11/01	245.45	Cash Sales - Bolts	\$\$\$	4010	
11/01	98.00	TSI Paid Bill-Disc.	1220	1050	
	2.00	TSI Took Discount	1220	4200	
	100.00	20 Cash Nuts	1241	4010	

A sample screen from Maccountant, a business- accounting program for the Macintosh

MAC

▶ **MACBOOSTER MEMORY MANAGEMENT**

MacBOOSTER, a cache memory-management system for 512K and larger Macintosh computers, can speed up the computer's operation by 2-10 times. The software stores frequently used disk-based data in a cache in memory, thereby reducing the number of times that a disk is accessed. The system is intelligent, using statistical analysis to select the best data to keep in the cache, and, once installed, is transparent to the user. It also guarantees data integrity and ensures that any modifications users make to

disk-based data are made to data in the cache memory as well. (List Price: \$50)

Requires: Macintosh Mainstay
28611B Canwood Street
Agoura Hills, CA 91301
(818) 991-6540

CIRCLE READER SERVICE NO. 567

MAC

▶ **RGS SOFTMAKER II**

RGS Softmaker II (New Version) is a database-management system that provides a variety of utilities, including deletion, mass deletion, merging, sorting, and renaming of data files. The software also features on-line help, password protection, formula definition for customized reports,



RGS Softmaker II is a database-management system for the Macintosh.

mathematical functions, and the ability to total all numerical columns with 14-digit accuracy. As an additional feature, the system can left-justify all alphabetical columns and right-justify numerical columns for easy-to-read reports.

(List Price: \$199)

Requires: Macintosh
Rio Grande Software, Inc.
221 Nolana
P.O. Box 5906
McAllen, TX 78504
(800) 527-1121
in TX (800) 292-1031

CIRCLE READER SERVICE NO. 568



NOW AVAILABLE AT YOUR LOCAL COMPUTER STORE

ESSENTIAL DATA DUPLICATOR III™

EDD runs on Apple II, II plus, IIe, IIc and Apple III (in emulation mode) using one or two disk drives.

EDD allows you to easily and quickly make back up copies of your "uncopyable" Apple disks. ■ Since EDD has been preset to copy the widest range of copy-protections possible, you just simply boot up EDD, put the disk you want to copy in one disk drive and a blank disk in the other (EDD will work using one drive also) and in about 2 ½ minutes a copy is made. ■ Unlike the "copy-cards" which only copy "single load" programs, EDD copies the entire disk. This would be similar to hooking up two cassette recorders, playing from one, and recording to the other. ■ We have even included an option so you can check the speed of your disk drives because drive speeds running fast or slow can damage disks and cause other problems. ■ We publish EDD program lists (Information about copy-protected disks) every couple of months, which EDD owners can receive. The current list is included with the purchase of EDD. ■ The bottom line is this; if EDD can't copy it, chances are nothing will.

\$79.95

Ask for EDD at your local computer store, or, to order direct, send \$79.95 plus \$2 shipping (\$5 foreign). Mastercard/Visa accepted. Prepayment required.

UTILICO MICROWARE
3377 Solano Ave., Suite #352
Napa, CA 94558 (707) 257-2420

Warning: EDD is sold for the sole purpose of making archival copies ONLY.

MAC

► **QUICKDISK FROM SYMMETRY**

An easy-to-use RAMdisk program, QuickDisk enables the Macintosh to operate up to ten times faster than normal by making a portion of the computer's memory look and act as though it were a superfast, silent disk drive. Users can select the size of the RAM-disk, from 50K up to 350K. Other features of the program include automatic file copy and automatic ejection of the startup disk. (List Price: \$34)

Requires: Macintosh Symmetry Corporation
3900 East Camelback Road Suite 103-S
Phoenix, AZ 85018
(602) 224-5944
CIRCLE READER SERVICE NO. 569

MAC

► **MAC COBOL LANGUAGE**

Designed for program developers, Mac COBOL is a COBOL language that provides access to 386 of the Macintosh's 512 ROM routines, enabling programmers to compile CALLS directly from ROM routines, as well as build Mac-

intosh windows and menus into their applications. Mac COBOL features Micro Focus' High Performance Level II compiler and is fully compatible with existing Micro Focus applications. Other features include a COBOL source-code editor; an ANSI '74 COBOL compiler; a generate tool, which compiles Micro Focus intermediate code into 68000 object code; a run tool, which allows users to execute multiple independent programs; a build tool, which combines programs with Micro Focus Application Support Modules; and ISAM file handling.

The second edition of Mac COBOL, available at no extra charge to customers who buy the first version, will provide access to the remaining Macintosh ROM routines and will contain features such as Forms, Animator, and Library. (List Price: \$2000)

Requires: Macintosh or Macintosh XL with MacWorks, 512K RAM, one disk drive
Micro Focus, Inc.
2465 E. Bayshore Road
Palo Alto, CA 94303
(415) 856-4161
CIRCLE READER SERVICE NO. 570

7
SERIES

► **STOCKPAK II SOFTWARE SERVICE**

CBS Software has reached an agreement with Standard & Poor's Corporation to market Stockpak II, a stock-market software service developed for use on home-computer systems. Stockpak II integrates an easy-to-use data-management program with a financial database that provides analysis information about 1500 actively traded companies. The program enables users to analyze and compare trends and the performance of one or more companies using tables and graphs, and they can then save or print resulting reports. The software includes a six-month subscription for updated financial database disks from Standard & Poor's; subscriptions for three additional databases are also available. (List Price: \$150)

Requires: Apple II Plus, IIe, or IIc
CBS Software
One Fawcett Place
Greenwich, CT 06836
(203) 622-2500
CIRCLE READER SERVICE NO. 571

MAC

► **INTOUCH TERMINAL EMULATOR**

A mouse- and menu-driven terminal emulator and file-transfer utility combined, inTouch allows the Macintosh to communicate with virtually any computer system and use programs written for specific terminals. As well as providing error-free file transfers at speeds of up to 19,200 baud, the program can emulate several popular video terminals. It can also support the

CompuServe Vidtex and Text, XMODEM, or Cross-talk protocols. Its Data Capture mode allows you to save a complete communication session to play back at your convenience. (List Price: \$149.95)

Requires: Macintosh Software Masters, Inc.
P.O. Box 570417
Houston, TX 77257-0417
(713) 266-5771
CIRCLE READER SERVICE NO. 572

► **ACCESSORIES**

7
SERIES

► **IIC TRAVEL CASE**

This sturdy case holds the Apple IIc, a IIc monitor on its stand, and an external disk drive. It also has an extra foam-padded compartment to hold a mouse or modem. Fiberbilt case #20439 is made of black polyethylene plastic and measures 21 x 13 x 16 inches in diameter. It features a tongue-and-groove aluminum frame and steel corners for durability, and it locks with a key. (List Price: \$175)

Requires: Apple IIc
Fiberbilt
601 West 26th Street
New York, NY 10001
(800) 847-4176;
(212) 675-5820 in NY
CIRCLE READER SERVICE NO. 573

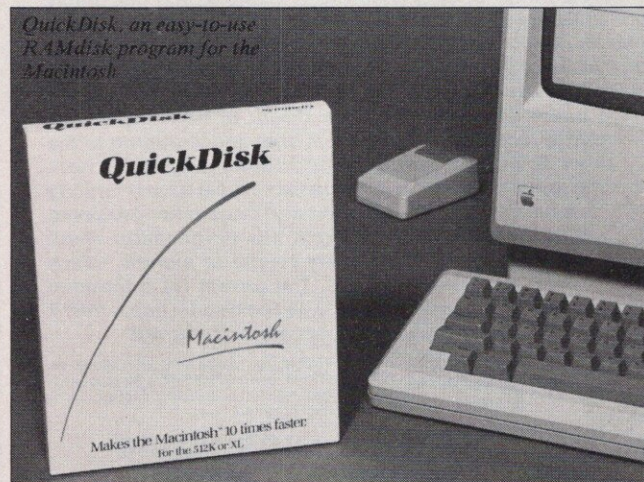

Back Up Your Software

E/D, III (Best Nibble Copier)	45.00
CIA Files (Best Disk Utilities)	21.00
Copy II Plus - Central Point	65.00
Locksmith 50 - Omega	62.00
Nibbles Away III	99.00
Copy Master II 128K w/Gr. Dump	79.00
Wildcard II - Central Point	99.00
Replay II - MicroAnalyst	79.00

Macintosh

Jazz	Call
Mac Turbo Touch	85.00
Back to Basics General Ledger	89.00
Copy II Mac	21.00
Factfinder	89.00
Ensemble	165.00
Hayden Speller	47.00
Mac Spell Right	59.00
Mac Spell +	59.00
Microsoft Chart	74.00
Microsoft File	114.00
Microsoft Multiplan	114.00
Microsoft Word	114.00
Microsoft Business Pack	349.00
ExpertLogo	78.00
Home Accountant (Mac)	59.00
Desk Organizer	59.00
TK Solver	145.00
Think Tank 128	75.00
BASF 3 1/2" Disks (5)	16.00
Maxell 3 1/2" Disks (10)	28.00
Verbatim 3 1/2" Disks (10)	28.00

Entertainment

Adventure Construction Set	34.00
7 Cities of Gold or Skyfox	27.00
Murder on the Zinderneuf	25.00
Archon II or One-On-One	27.00
Pinball Construction Set	25.00
Gato	29.00
Ghost Busters or Pitfall II	27.00
Tracer Sanction or Mind Shadow	27.00
Miner 2049er or The Heist	24.00
Wizardry	30.00
Knights of Diamonds	21.00
Legacy of Lyliamyn	24.00
Return Of Werdna	27.00
Rescue Raiders	22.00
Wispriest	16.00
Super Zaxxon or Frogger 3 Deep	25.00
The Quest or Ring Quest	21.00
Expedition Amazon, or Xyphus	21.00
Sword of Kadash	21.00
Below The Root	20.00
Swiss Family Robinson	20.00
Millionaire, Tycoon, or Barron	20.00
Solo Flight or Nato Commander	22.00
Amazon or Dragon World	25.00
Fahrenheit 451 or Shadow Keep	25.00
Flight Simulator II	32.00
Championship Lode Runner	22.00
Choplifter or Karateka	22.00
Pole Position or Zaxxon	20.00
Bruce Lee, Conan, or Mr. Do	24.00
Spy Hunter, Star Trek, or Tapper	27.00
Murder By The Dozen or Felony	25.00
Kings Quest	30.00
Beyond Castle Wolfenstein	30.00
Ultima III: Exodux	35.00
Sargon III	31.00
Cuthroths, or Sealstalker	24.00
Hitchhiker's Guide To The Galaxy	24.00
Deadline, or Starcross	30.00
Witness, Planetfall, or Enchanter	24.00
Infiltrator or Sorcerer	27.00
Zork I, Zork II, or Suspect	27.00
Zork I	24.00
Operation Market Garden	35.00
Objective Kursk or Phantase	24.00
War In Russia	30.00
50 Mission Crush or BroadSides	24.00
Kampfruppe or Reforged 88	36.00
Imperium Galactum	24.00
Germany 1985 or Carrier Force	36.00
Baltic 85 or Gemstone Warrior	21.00
Geopolitic 1990 or Rails West	24.00
North Atlantic '86	24.00
Battle For Normandy	24.00

Utility

Apple Mechanic	17.00
Beagle Basic	20.00
Beagle G.P.L.E.	29.00
Beagle Graphics	33.00
D-Code	23.00
Disk Quick	17.00
Dos Bos	14.00
Double Take	20.00
Extra K	23.00
Fat Cat	20.00
Flex Text	17.00
Frame Up	17.00
I.O. Silver	17.00
Pro-Byter	20.00
Silicon Dos	17.00
Pronto Salad	14.00
Triple Dump	23.00
Typefaces	11.00
Utility City	17.00
Bag of Tricks	25.00
AppleSoft Compiler (Microsoft)	109.00
Lisa V26	54.00
Merlin Pro	62.00
Merlin Assembler	37.00
Merlin Combo Pack	66.00
Turbo Pascal or Turbo Toolkit	33.00
Visible Computer: 6502	32.00
The Graphics Magician	36.00
New Complete Graphics Sys.	48.00
Dazzle Draw	37.00
Pix-It	30.00
Take 1	36.00
Blazing Paddles	30.00
Zoom Graphics	31.00
Sideways	36.00
Fontrix V 1.5	59.00
Font Paks 1-13 ea.	15.00

Blank Media

Elephant SS/DD (10)	12.50
Maxell SS/DD (10)	16.95

Verbatim SS/DD (10)	16.95
BASF SS/DD (10)	14.95
Maxell SS/DD (10)	14.95
3M SS/DD (10)	17.95
Dysan SS/DD (10)	22.95

Business

Apple Access I / II / III / IV	59.00
Apple Writer I / II / III / IV	124.00
Quickfile I / II / III / IV	79.00

Advanced Logic Systems

List Handler (II+ / I / II / I / C)	47.00
The Handlers (II+ / I / II / I / C)	103.00
Word Handler II (II+ / I / II / I / C)	47.00

Applied Software Technology

Versafarm	55.00
-----------	-------

Artsci MagicCalc

Magic Office System	185.00
Magic Window II	94.00

BPI Systems

GA, AR, AP, PR or INV. ea.	235.00
----------------------------	--------

Continental Software

F.C.M./J.L.	61.00
G.L., A/R, A/P, Payroll ea.	144.00
Home Cataloger	31.00

Creative Peripherals

Time Trax I / II or I / C Version	85.00
-----------------------------------	-------

Dow Jones Software

Investor's Workshop	89.00
The Market Analyzer	208.00
The Market Microscope	208.00

Hayden Software

Pie Writer V2.2	95.00
-----------------	-------

Human Edge Software

Communications Edge	119.00
Management Edge	149.00
Mind Prober	31.00
Sales Edge	149.00

Kensington Microware

Format II Enhanced	90.00
--------------------	-------

Living Videotext

Think Tank II+ or I / C	85.00
-------------------------	-------

MegaHaus MegaFinder

MegaSpells	37.00
MegaWork	77.00
MegaWriter	64.00

Micropro Calcstar

Infostar w/z-Card	49.00
Infostar w/z-Card	120.00
Wordstar w/z-Card	169.00
Wordstar Pro w/z-Card	228.00

Microsoft

Microsoft Softcard w/dBase II Multiplan (Apple Dos Version)	329.00
Multiplan (Apple Dos Version)	59.00

Organizational Software

Omnis 2	199.00
Omnis 3	339.00

Peachtree

Back To Basics Accounting	125.00
Practicoor Practicial II	35.00

Quark

Word Juggler & Lexichack I / II	118.00
---------------------------------	--------

Sensible Bookends

Graphics Department	72.00
The Sensible Speller	72.00

Sierra On-Line

The General Manager II	131.00
The Screenwriter I / II	78.00
Software Arts TKI Solver	179.00
The VisiCalc Package	114.00

Software Publishing PFS File

PFS:Graph	72.00
PFS:Report	72.00
PFS:Write (I / II / I / C)	72.00
PFS:Proof	72.00
PFS:Access (I / II / I / C)	43.00

Sorcim/IUS SuperCalc 3a

SuperCalc 3a	119.00
--------------	--------

State of the Art

Electric Checkbook	59.00
--------------------	-------

Stoneware

DB Master Business Team	219.00
DB Master Business Writer	98.00
DB Master Version Four Plus	185.00

Visicorp

Flashcalc II+ / I / II / I / C	62.00
VisiSchedule	92.00

Math

Algebra 1, 2, 3, or 4	22.50
Algebra 5 or 6	27.50
Compu-Read	17.00
Compu-Math: Arithmetic Skills	29.00
Hands on BASIC Programming	32.00
Introduction to Counting	25.00
Learning To Read 1, 2, 3, or 4	25.00
PSAT or SAT Word Attack Skills	18.00
Spelling Bee w/Reading Primer	23.00
Writing Skills 1, 2, 3, or 4	25.00

Scarborough Systems

Mastery's Writing Wizard	49.00
Build A Book About You	26.00
Original Boston Computer Diet	52.00

Scholastic Wizware

Agent U.S.A. or Turtle Tracks	24.00
Operation: Frog or Logic Builders	24.00
Logo Robot or Kids at Work	19.00

Simon & Schuster

Discovering Your Baby-Birth to 2	49.00
JK Lasser Money Manager	62.00

Spinnaker

Adventure Creator or Trains	27.00
Aerobics or Scooter Troops	24.00
Counting Parade	21.00
Delta Drawing	31.00
File & Report or Spreadsheets	42.00
Friction Fever or Sum Duckets	19.00
Grandma's House	19.00
In Search Of...	25.00
Kidwriter or Kindercomp	25.00
Treasure Island or Wizard of Oz	42.00
Word Processor	42.00

Springboard

Early Games or Music Maestro	21.00
Fracture Factory or Make a Match	19.00
Rainbow Painter or Puzzle Master	21.00

Sunburst

Challenge Math or The Factory	30.00
Teasers by Tebbis	33.00
The Incredible Laboratory	30.00
Terrapin Terrapin Logo	60.00

Xerox Chivalry

Exploring Tables & Graphs 1 or 2	32.00
Pic Builder	24.00
Stickybear Series (ea.)	24.00

Modems

ERA 2 by Microcom	345.00
Hayes Micromodem I / II	135.00
Hayes 300 Baud Smartmodem I / C	159.00
Hayes 300 Baud Smartmodem	135.00
Hayes 1200 Baud Smartmodem	389.00
Hayes 2400 Baud Smartmodem	599.00
Novation Apple Cat II	192.00
Novation 212 Apple Cat II	369.00
Pro Modem 1200 (External)	Call
Pro Modem 1200A (Internal)	Call
Popcorn X-100 (1200 Baud)	Call
Zoom/Modem I / II	119.00
Zoom/Modem I / II Plus	139.00

Z80/80 Col./Ramcards

Applied Engineering: RamWorks	Call
Applied Engineering: Z-RAM I / C	Call
Checkmate - Multiview 80/160	219.00
Checkmate - Maxram Cards	Call
Quadram Multicore Card	Call
Apturion 16K Ramcard	68.00
Saturn 128K Ram	199.00
Neptune 80 Col. 64K Card	185.00
Extend 80 (Caribbean Computer)	115.00
Videx Videoterm w/SS Inv.	178.00
Videx Ultraterm	199.00
ALS Z-Engine 2.2	149.00
Microsoft Premium Softcard I / II	259.00
Microsoft Softcard II	239.00
MTC Speed Demon	199.00
Accelerator I / II	239.00

Interface Cards

Apple Super Serial Card	125.00
Serial Interface Card	115.00
AST Multi IO	175.00
Serial Grappler Plus	79.00
Grappler+	79.00
Buffered Grappler+	145.00
Finger Print (Spies Labs)	125.00
Finger Print Plus	99.00
Print-It	135.00
Pkaso/U Interface	119.00

Educational

Apple Apple Logo I / II / III / IV	82.00
Barton's Computer SAT	53.00
CBS Software Adventure Master	32.00
Spreadsheet Data A, B, C, or D	15.00
Spell-It or Word Attack	30.00

Designware

The Body Transparent	28.00
European Nations & Locations	28.00
Grammar Examiner	28.00
Remember	55.00
States & Traits	28.00

DLM Alligator Mix

Demolition Division	20.50
Freddie's Puzzles	19.00
Spelling Wiz	20.50

Harcourt Brace

Computer SAT	47.00
--------------	-------

Learning Company

Addition Magician	21.00
Bumble Plot or Reader Rabbit	24.00
Gertrude's Puzzles	27.00
Juggler's Rainbow	18.00
Magic Spell or Word Spinner	21.00
Robot Odyssey or Rocky's Boots	30.00

C.Itoh

ProWriter 8510 AP	295.00
ProWriter 1550 AP	445.00
ProWriter 8510 AP Plus	329.00
ProWriter 1500 AP Plus	469.00
ProWriter 8510 BC-2 (Mac. / I / C)	399.00
Daisy Writer 2000	799.00

Epson

Call	229.00
For	Call
Most	Call
Recent	Call
Low Low!	Call
Prices!	Call

Juki 6100P

369.00
689.00

NEC SpiritWriter 2050 (20 cps)

669.00
1029.00

Okidata Microline 182P

219.00
369.00
499.00
369.00
349.00
659.00

Panasonic KXP-1090

189.00
249.00
379.00
449.00
419.00

Silver Reed EXP-400P

249.00
249.00
419.00
739.00

Star Micronics SG-10 (120 cps)

235.00
395.00
355.00
475.00
495.00
595.00

Toshiba P-1340

579.00
1199.00
1199.00

Princeton Graphics

HX-12 RGB	459.00
RGB-80 Interface	149.00

Teknika

MJ-22 RGB Color Monitor	319.00
-------------------------	--------

Sakata SG-1000 Green

SA-1000 Amber	95.00
SC-100 Composite Color	115.00
SC-100 Composite Color	145.00

Taxan

115 12" Hi-Res Green	120.00
116 12" Hi-Res Amber	125.00
RGB Vision III (Hi-Res)	37.00
220 14" Composite Color	249.00
420 12" Hi-Res RGB Color	399.00
410/80/64 RGB-II Interface	175.00

Home Software

Home Accountant	43.00
Dollars and Sense (II+ / I / II)	59.00
Dollars and Sense (I / C)	70.00
Monogram Forecast (64K or 128K)	38.00
Time is Money	60.00
Money Street	75.00
Networth	48.00
Financial Cookbook	34.00
Cut and Paste	25.00
The Write Choice	27.00
Bank Street Speller	41.00
Homework	41.00
Homework Speller	31.00
ASCII: Express Professional	78.00
Softerm II	125.00
Compuserve Starter Kit	23.00
Typing Tutor II	15.00
Typing Tutor III	31.00
Master Type	24.00
Crossword Magic	31.00
Micro Cookbook (II+ / I / II)	23.00
Music Construction Set	27.00
Print Shop	29.00
Print Shop Graphics Library	25.00
Verbatim Drive Analyzer	24.00

Disk Drives

Apple Disk II Drive	299.00
ProFile (5 Meg) w/Accessory Kit	1135.00
ProFile (10 Meg) w/Accessory Kit	1599.00
Apple I / C External Drive	269.00
Macintosh External Drive	399.00

Corvus Systems

OmniDrive Hard Disks	Call
----------------------	------

Micro Sci A2 Full Height

A5 Slimline I / II	189.00
A5 Slimline I / C	185.00
Micro Sci C2 Controller	96.00

Rana Elite I

Elite II	189.00
Elite III	355.00
Elite III	425.00
Rana Disk Controller	79.00

Quark

QC-10 Hard Disk I / II / I / C or Mac	1095.00
QC-20 Hard Disk I / II / I / C or Mac	1859.00

Monitors

Amdex	Call
Video 300G 12" Green Monitor	125.00
Video 300A 12" Amber Monitor	130.00
Color Monitor 300 (Composite)	235.00
Color Monitor 500 (RGB)	329.00
Color Monitor 600 (RGB)	409.00

Panasonic

TR120M1 Hi-Res Green	119.00
TR120M1 Hi-Res Amber	125.00
DT5101 Dual Mode Color 10"	189.00
DTM140 Hi-Res 14" RGB Color	409.00

Accessories

Kensington System Saver	64.00
Cool + Time	69.00
Apple Mouse I / II	125.00
Apple Mouse I / C	85.00
Hayes Mach II Joystick	29.00
Hayes Mach III Joystick	34.00
Kraft Joystick	32.00
Gibson Light Pen	158.00
Digital Paintbrush System	175.00
Muppet Learning Keys	44.00
Koala Pad	75.00
Key Tronic Keyboard	245.00
Trackhouse Keypad	85.00
Mockingboard A Board	75.00
Mockingboard C Board	129.00
Mockingboard D Board (I / C)	134.00
Echo II Plus	95.00
The Cricket I / C	115.00

Printers

Apple	Call
ImageWriter	

ADVERTISING RATES AND INFORMATION

Standard listings consist of a bold lead line (23 characters maximum); 7 lines of body copy (45 characters per line); 4 lines for company name, address and telephone number. \$145 per insertion—3 issue minimum. Additional charge for extra lines and company logos. Prepayment and frequency discounts available. American Express, MasterCard, Visa accepted. Copy subject to publishers approval. Send typewritten or printed copy, reproducible logo art (if applicable) and remittance to Kathryn Cumberlander, Classified Sales Manager, Ziff-Davis Publishing Company, One Park Avenue, New York, NY 10016. For additional information, assistance, or to place an order by phone, call collect (212) 503-5115.

▶ACCESSORIES/ SUPPLIES

IMAGEWRITER CASES

Take your small or wide carriage Imagewriter with you in style. Computote offers weatherproof, padded cases, with plenty of room for paper and supplies. Special introductory offer: Imagewriter, Now \$55.21, Wide carriage Imagewriter, now \$63.71, Macintosh, now \$84.95. Visa/MC or COD.

COMPUTOTE
PO Box 953
Naperville, IL 60566
Toll Free 1-(800) 323-2748

MAC PRODUCTS

Mousepad—\$9.95. Mousetrap Poster—\$4.95. Mac Trap: The Better Mousepad—\$9.95. Mouse Clean Kit—\$11.95. Mac-Visor—\$9.95. Keyboard Extenders—\$46.95 clear/\$59.95 smoke. MacStand—\$39.95 clear, \$49.95 smoke. Printer Stand \$32.95. Write or phone for free brochure!

PERK COMPANY
150 Commercial St.
Sunnyvale, CA 94086
(408) 735-1807

3½" SONY DISKS FOR MAC

For awhile, SONY diskettes were not available for retail. THEY ARE NOW!! We are now introducing these diskettes at a special price of \$29 per box of ten. If desired, you can choose either blue or beige. All in stock. Please send \$29 plus \$3 for handling/shipping. (CA residents add state sales tax) send to:

PBI Software
1155 B-H Chess Dr.
Foster City, CA 94044
(415) 349-8765

CATHODE RAY TUBES

The best replacement tube on the market today is called "ORANGE DROP". Reduces eye fatigue and strain. 1 year warranty. Money back guaranteed. Available in 5", 7", 12 and 14". Fits 95% of all monitors and terminals. Used and recommended by Wyse and Televideo. Sugg. retail: 12"—\$109/14"—\$119. Dealers Welcome.
SAS ELECTRONICS, INC.
574 Weddell Da., Suite #3
Sunnyvale, CA. 94089
(408) 245-5000

COLOR AND TRANSFER RIBBONS

Nylon, \$9.00 each in red, blue, brown, purple, yellow, green or black for Imagewriter and Apple DMP. Transfer graphic design with iron to T-shirts and so forth with heat transfer ribbons \$12.00 each in red, blue, yellow, and black. Order in twos, any mix. Postpaid Check/Visa/MC.
Sharp Color
578 Lynwood Lane
Lancaster, Ohio 43130
(614) 687-0129

▶HARDWARE/ADD ON BOARD

MICROPORT

Digital I/O card provides 32 lines, 2 hand-shake lines for error free comm., interrupt arbitration circuit, TTL compatible. Full documentation & sample programs in basic & 6502. Excellent choice for any digital monitoring and/or control app. High quality glass epoxy PC board, soldermask & gold contacts. 3yr. warranty on assembly products. Assembled & tested \$88, Complete Kit \$65, Visa/MC/C.O.D. GA Res. 3% tax.
MICRO SYSTEMS RESEARCH
4099 Maxanne Dr.
Kennesaw GA 30144
(404) 928-9394

▶HARDWARE/ PERIPHERALS

MACINTOSH-APPLE IIC

MAC BUFFER eliminates printer delay. 128-256k memory. SERIAL TO PARALLEL CONVERTERS for the IIC allow interconnection of a wide variety of peripherals. Connect of centronics compatible parallel printers, plotters, or a host of other devices. Add buffering and free-up your computer! Prices start at \$79.95
TECHNOLOGIC SYSTEMS
PO Box 44
Raymond, OH 43067
(614) 890-6960

MOUSETRACER

Use your Mac, Iie, or Iic mouse and draw like the pros! Put cartoons, pictures, maps, etc. on the drawing board. Strap your mouse to the Mousetracer and use your favorite graphics program to trace the picture of your choice. Works like a 1:1 drafting pantograph. Send \$34.95 + \$3 UPSshipping (CA res add \$2.10 sales tax) to:
BRIMARK INNOVATIONS
9821 Yolanda Ave.
Northridge, CA 91324

▶PUBLICATIONS

EASY MACPAINT, MACWRITE APPLEWRITER Iie 3.3, III

Learn program or refresh your memory at a glance. Save time! Reference sheets summarize, condense, explain commands. WPL, Apple DM printer codes. MacPaint made clear, hints gathered from many sources. Why pay more? MacPaint/MacWrite send \$4.95. AW Iie DOS 3.3 or AW III (final) send \$3.95 to:

Self-Help Publications
PO Box 1293
Ashland, OR 97520

▶SOFTWARE/ ACCOUNTING

MAC ACCOUNTING

The advantage of our Accounting, Tax, and Aging programs are beyond the scope of this ad to describe. At \$29.50 per program, or all for \$75.00, the businessman or the accountant will find flexible accounting at a bargain price! Please call or write for further information.

BAGEANT ACCOUNTING SERVICES
6200 Beach Blvd.
Jacksonville, FL 32216
(904) 398-3003

PAYROLL FOR THE MACINTOSH

Will calc. weekly, bi-wkly, semi-monthly and monthly payroll. Std. deductions calculated + retained for employees w/5 custom deduction acct's. 30 Empl. on 128k, 100 on 512k. Print checks, W-2/W-3, 941 report + much more. Uses 5 method for State w/holding + needs MS BASIC, free compiled vers. when avail. \$495 + ship.
MANUFACTURING SOLUTIONS
3885 Industrial Ave.
Rolling Meadows, IL 60008
(312) 392-3765

▶SOFTWARE/ BUSINESS

MOUSE POUCH MAILER

Generates 20 different forms, including postcards, trans-o-grams, labels, envelopes, self-mailers, and name badges. Features help function flowchart, list merge return addresses, common messages, and 3-way autosort. Easy to read menus and screen pictorials. Single key commands. Requires 512k. \$39.95. \$2, s/h. CO+3%. CK/MC/VISA.
SOFDEX INTERNATIONAL
P.O. Box 2419
Longmont, CO. 80501
(303) 678-0624

▶SOFTWARE/ DENTAL

DENTIVISION® ON MACINTOSH™

Dentists can now, thanks to modifications on the Mac'sSystem, access detailed information including graphics on their patient's files at the press of the mouse. Files are unlimited (subject to memory available on disk). Requirement Filevision™. \$24.95 (bank check). Airmail shipping software & manual included. (Filevision™ program not included.)
B. MULLER
P.O. Box 32 Postkantoor Charlottalei
Antwerp 11, Belgium

▶SOFTWARE/ EDUCATIONAL

GRADEBOOK MANAGEMENT

DA POMA GB GradeBook Management for microcomputers—lets a teacher or professor record & calculate grades on a micro-computer. Some of the features are: up to 8 classes per data disk, drop lowest score in a category, trend analysis, & much more! Available for Apple II's, MACINTOSH, & Radio Shack Model 4.
DA POMA INC.
PO Drawer H
Hondo, TX 78861-0240
(512) 426-5932

►SOFTWARE/ ENTERTAINMENT

SOLITAIRE FOR MACINTOSH

Match your skill and luck against Klondike or Canfield, the most popular versions of Solitaire. Both games feature quality graphics and fancy score keeping that allows you to play not only against the game, but against your friends too. If you're looking for fun on the Mac, discover Klondike or Canfield. Only \$19.95 ea., \$29.95 both. Add \$2.00 shipping.

COMPUTING CAPABILITIES
465-A Fairchild Dr. Suite 122
Mountain View, CA. 94043
(415) 968-7511

►SOFTWARE/ ONE OF A KIND

ENVELOPE ART™

Put a piece of your personality into your mail. MacPaint™ your envelopes & stationery. For yourself, for gifts, or as a creative business idea. Includes blank envelopes, preprinted assortment & disk with sample designs, templates & instructions. Complete kit \$29.95 (+ \$2.10 tax NY). CK/VISA/MC. Send \$3 for preprinted envelope sample only.

ENVELOPE ART™
2669-3 Camelot Rd., P.O. Box 129
Endwell, NY 13760
(607) 754-7317

►SOFTWARE/ SCIENTIFIC

SCIENTIFIC ANALYSIS PROGRAM

A scientific and numerical analysis package designed to solve linear, nonlinear, complex, real, matrix, definite integrals, polynomials, differential equations and features high-res graphics. It selects the best curve to fit data by least squares or interpolations. It includes two disks and requires BASIC. \$38.00.

PCA SOFTWARE
PO Box 1231
Arlington, TX 76010
(817) 860-5498

DAYTON MATH FONTS

The most complete scientific character set for any word processor. Integrals, products, tensor products, sums, etc. 4 levels of subscripting + super-scripting. Tool kits for your own functions. Free updates. Complete Greek character sets, caps and lower case, old + new characters. Ideal for languages. \$31.95.

PLUGH, INC.
595 Royal Springs
Springboro, OH 45066
(513) 748-2423

PLOT THE HEAVENS

ASTRONOMY plots a Pole-Star's eye view of the solar system and an earth-bound observers image of the heavens for a given date, time, longitude and latitude. ASTRONOMY plots the sun, moon, planets, comets and many major constellations. ASTRONOMY runs under Microsoft Basic V2. \$25.00 + \$3.00 P/H.

E & M Software
95 Richardson Rd.
North Chalmers, MA 01863
(617) 251-7451

►SOFTWARE/ UTILITIES

TRACK YOUR COMPUTER'S USE

COMPU-LOG™ records computer time by any of 25 applications. A MUST if your Apple is tax deductible. Compatible with TIMEMASTER II HO and other clock cards (not required). Reports to screen and/or printer. Unlocked. For Apple II+ /e/c with 48K and 1 disk drive. \$14.95 + \$1.50 S&H, NY Res's add sales tax.

HILDRETH SOFTWARE, INC.
Dept. AA, 127 Sannita Drive
Rochester, New York 14626
(716) 227-3609 (Evenings/Weekends)



REPRINTS AVAILABLE

Quantity reprints of articles appearing in A+ Magazine are available and will be prepared to meet any special requirements. Inquiries should be directed to Eileen Pfeiffer, Reprints Dept., Ziff-Davis Publishing Co., 1 Park Ave., New York, New York 10016. Phone 212-503-5447.



If You Work With One Of These...
...You May Be Entitled
To A Corporate Discount
On One Of These.

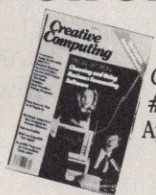

Creative Computing. The
#1 Magazine of Computer
Applications and Software



A+, The Independent
Guide for Apple
Computing

*PC, The Independent
Guide to IBM
Personal Computers*



PC Tech Journal,
The Magazine for IBM
PC Experts



SAVE UP TO 50% WITH THE ZIFF-DAVIS CORPORATE SUBSCRIPTION PROGRAM

Complete and mail this coupon, or for faster service, call
Daniel Rosensweig collect at 212-503-5354.

THE MORE YOU ORDER THE MORE YOU SAVE!

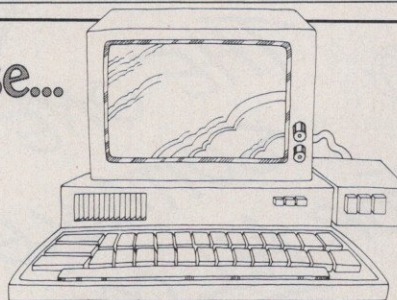

ZIFF-DAVIS Corporate Subscription Program
One Park Avenue, 4th Floor
New York, NY 10016
Attn: Daniel Rosensweig

YES, I want more information on saving money through
the ZIFF-DAVIS Corporate Subscription Plan.

Please have Dan Rosensweig call me at: CA01

()

Name _____ Title _____

Company _____

Address _____

City _____ State _____ Zip _____



THE ONE GIFT
SUITABLE
FOR ALL OCCASIONS!

Give a friend a new gift every month with A+! It's a great way to tell them that you're thinking about them, while you provide them with hours and hours of useful information, facts and ideas! When you give A+ as a gift subscription you're giving new applications, innovative ideas, in-depth product reviews and evaluations, and months and months of information for Apple II series and Macintosh computers! This is a perfect gift for birthdays, promotions, graduation, the holidays and a reminder that you're always thinking about them! An attractive signed gift card will be sent in your name with every gift you order!

One year (12 issues) only \$19.97.
Save 20%!

**FOR FAST SERVICE PHONE TOLL
FREE 1-800-852-5200**

Savings based on full one year (12 issues) subscription price of \$24.97.

RESCUE SQUAD BY MICHAEL CALLERY

Questions from our readers

► DISK BACKUPS

Q. I recently saw some ads for *Essential Data Duplicator* and *Copy II Plus* in your magazine. Having just accidentally destroyed my *Deadline* disk, I would like to know if these backup utilities work.

A. Yes, they work with most software. You may need to know special parameters or methods to make a backup copy with them, though. The copy will still be copy-protected; thus, you will not be able to use COPYA to produce a copy of the copy.

I recommend sending your damaged disk back to Infocom for replacement—the company will send you a new one for \$5. Most other publishers have similar policies.

Copy-protection is a sticky subject. Producing software is costly, and many publishers feel that they must protect their investment from unauthorized duplication and distribution.

Apple's official policy is not to copy-protect its software unless the author insists. Thus, Apple Writer is protected, but AppleWorks is not. Apple includes a backup disk in the AppleWriter package, though. Other publishers may charge a small fee for a backup disk. Most game publishers replace damaged disks for \$5. United States copyright law states that you are entitled to make a single backup copy of software that you own, but the case of software that is licensed to you is not as clear-cut.

An important point here is that developers will produce new software only if they can get a reasonable return on their investment. New software is the only thing that is going to keep *your* investment in your Apple worthwhile. So back up your software for your own use only.



► DISK DRIVE VS. RAMDISK

Q. I have an Apple IIe with one disk drive and realize that I need another. I have read many articles that describe the benefits of RAMdisks, however. I work in Pascal and with CP/M in addition to DOS. Should I purchase a RAMdisk or a regular disk drive?

A. Although RAMdisks do have their advantages, a regular disk drive is probably your best choice for a second drive.

Two different types of RAMdisks are available for Apple IIe computers. The first kind plugs into the standard expansion slots and also works with Apple II and II Plus computers. These interface cards have a lot of memory (I have one with 292 K), and you can configure them to emulate one large disk or several smaller ones, depending on your needs and the operating system (DOS, Pascal, or CP/M).

The other type of RAMdisk plugs into the auxiliary slot and functions as an 80-column card, in addition to having RAMdisk capabilities. In fact, un-

der ProDOS, the standard Apple Extended 80-Column Card can function as a RAMdisk with about two thirds of the capacity of a standard floppy disk. Extended 80-column cards from other manufacturers offer greater capacity.

The RAMdisk capabilities are a function of the software you are running. Most manufacturers offer DOS 3.3, ProDOS, CP/M, and Apple Pascal RAMdisk software. Your current programs may or may not work with this new software. Generally, DOS 3.3 software that allows entry of a slot number when you're loading or saving files does work with RAMdisks. Pascal users must specify the correct volume name for the RAMdisk, and CP/M users have to indicate addresses by disk name (C:, D:, and so on). Software that modifies the operating system to coax better performance from the Apple Disk II probably will not work with a RAMdisk. Software that you have to boot to run, such as most copy-protected pro-

The Byte General

3 Sierks Lane, Dept. 40, Roslyn Harbor, NY 11576

Toll Free National 24 Hour Order Line

800-645-3286 (Orders Only)

Customer
24 Hour Order Line Service/Technical
516-625-0920 516-484-6391

Free Shipping On Prepaid Orders
(Check With Order) Please refer to AD#40

Diskettes:

Elephant SS/SD	\$ 12.00
Elephant SS/DD	\$ 13.00
Elephant DS/DD	\$ 17.00
Elephant Bulk SS/DD - .84 Each, \$84/Hundred	
Elephant Bulk DS/DD - .94 Each, \$94/Hundred	
(Lifetime warranty on all Elephant Products)	

Modems:

Anchor Automation Volksmodem 300 Baud	\$ 49.00
Anchor Automation Volksmodem 12 300/1200 Baud/ Hayes 1200 Compatible Auto Dial/Auto Answer	\$179.00
Anchor Automation Volksmodem Cable (Specify Computer)	\$ 15.00
Hayes Micromodem IIe w/ Smartcom Software	\$149.00
Hayes Smartmodem 300 (Apple IIc Version) w/ Smartcom Cable	\$169.00
Hayes Smartmodem 1200 Standalone 300/1200 Baud	\$389.00
Novation Apple Cat II	\$199.00
Novation Apple Cat 212 Upgrade	\$220.00
Novation Apple Cat 212 System	\$375.00
Prometheus Promodem 1200 Apple Incard 300/1200 Baud	\$299.00
Prometheus Promodem 1200 Standalone 300/1200 Baud	\$315.00
Zoom Modem IIe w/ Netmaster Software/Delphi/ Dow Jones/Micromodem IIe Compatible Auto Dial/Auto Answer	\$119.00

Apple Accessories:

4164 150ns Ram Chips Each	\$ 1.29
16k Ram Card, Apple II+	\$ 45.00
AST Multifunction Board w/ Clock, Modem Port	\$175.00
ALS Zengine CPM Card, Includes CPM 2.2 Diskette	\$109.00
ALS Smarterm II, 80 Column Card Apple II+ Version	\$109.00
Apple Brand Disk Controller	\$ 50.00
Gibson Light Pen	\$160.00
Orange Micro Grappler Plus	\$ 89.00
Orange Micro Buffered 64k Grappler Plus	\$165.00
Kensington System Saver	\$ 65.00
Super Cooling Fan, 2 Outlets/Surge Protector	\$ 29.00
Koala Pad, Apple IIc/IIe Version	\$ 69.00
Koala Pad, Apple II+ Version	\$ 72.00
Kraft Joystick Apple IIc/IIe Version	\$ 35.00
Kraft Joystick Apple II+ Version	\$ 35.00
Generic Apple Super Serial Card w/ Cable	\$ 89.00
Generic Joystick, (Kraft Clone)	
Connectors For Apple IIc/IIe/II+	\$ 25.00
Generic Parallel Printer Card w/ 6 Foot cable	\$ 39.00
Extended 64k 80 Column Card, (Appleworks 55k Available)	\$ 59.00
Echo Speech Synthesizer	\$ 94.00
Thunderclock	\$109.00
Videx 80 Column Card w/ Softswitch	\$199.00
Videx 160 Column Ultraterm Enhanced	\$199.00

Apple Disk Drives:

Mitac Apple II+/IIe Disk Drive	\$129.00
Mitac Apple IIc Disk Drive	\$129.00

Printers:

C. Itoh 7500AP (105cps)	\$219.00
C. Itoh 8510AP (120CPS, NLQ)	\$289.00
C. Itoh 1550 (15' Carriage, 120cps)	\$425.00
Okidata 192 NEW! (160 CPS, NLQ)	\$349.00
Okidata 182	\$279.00
Star Micronics SG-10	\$219.00
Star Micronics SG-15	\$379.00
Star Micronics SD-10	\$350.00
Star Micronics SD-15	\$399.00
Star Micronics SR-10	Call
Juki 6100 Daisy Wheel	\$359.00
Juki 6300 Daisy Wheel	\$659.00

Ribbons:

C. Itoh 8510/7500/1550	\$ 5.00
Okidata 92	\$ 2.00
Epson FX/RX/MX/80 Ribbon	\$ 5.00

Apple Computers:

Apple IIc 128k Disk Drive/Monitor	\$989.00
Apple IIe Enhanced CPU 64k Alone	\$650.00

Dealer Inquiries Invited — 516-625-3020

Terms of Sale: Prices and terms of sale are subject to change w/out notice. We are not responsible for typographical errors. Call for return policy. All prices reflect a 3% cash discount. Prepaid orders by cash/certified check, or money order receive Free Shipping. Credit Card sales do not qualify for free shipping. NYS Residents add 8.25% sales tax. Please refer to AD #40 when ordering.

CIRCLE 306 ON READER SERVICE CARD

grams, probably will not work with a RAMdisk.

Furthermore, if you forget to transfer your programs or data from the RAMdisk back to a floppy disk before turning off the computer, or if you suffer a sudden power loss, you'll lose all your data. These problems don't exist for a second physical disk drive.

On the other hand, programmers—especially Pascal programmers—can greatly benefit from RAMdisks.

Compiling and linking from a RAMdisk is a dream. Were you considering a third disk drive, I wouldn't hesitate to recommend a RAMdisk.

► KEYBOARD UPGRADES

Q. As a long-time Apple II Plus user, I have tried just about everything to get around the shortcomings of the keyboard. Replacement keyboards are expensive, although recently I have noticed ASCII-encoded keyboards for less than \$100. What can I do?

A. I have a Videx Keyboard Enhancer on my Apple II Plus and have had no problem adapting to its peculiarities (e.g., to enter the Uppercase/Lowercase mode with the Videx Enhancer installed, you must press Reset). Installation is simple if you have the keyboard-encoder board hanging from the bottom of the keyboard (i.e., if you have a Rev. 7 or later motherboard). The latest version of the Videx product (Enhancer II) also has an optional strip of function keys but does not offer a numeric keypad.

To get your Apple to display uppercase and lowercase letters without an 80-column card, you must purchase a new character-generator ROM (I recommend the Paymar ROM). Installation is as simple as it is with the Videx Enhancer and requires only a chip puller. Unless you enjoy taking your Apple computer apart, install both the Enhancer and the new ROM at the same time.

If you have an 80-column card and do not use the normal Apple 40-column text screen much, you do not need the new character-generator ROM. Your 80-column card can already generate uppercase and lowercase letters.

If you want a numeric keypad, consider purchasing a high-quality (read expensive) add-on keyboard. The inexpensive keyboards are not very good; their keys stick and they give you duplicate characters on the screen (keyboard bounce). One of the most popular of the add-on keyboards is produced by Keytronics (P.O. 14687, Spokane, WA

99214 [509]-928-8000). With an external keyboard and no 80-column card, you will still need a new character-generator ROM.

After all of this, you may be better off purchasing an Apple IIe and an Apple numeric keypad. I don't know what additional peripherals you have on your system, but most of them should work with the IIe. You'll gain the better keyboard, the uppercase/lowercase ROM, and the ability to run all the latest software, such as AppleWorks.

► PRINTER-CONTROL CODES

Q. My Panasonic KX-P1090 printer does not respond to printer commands as I expect them to in Apple Writer. For example, the printer manual states that, from BASIC, I should type PRINT chr4(27);"W", CHAS(1). When I assign an Apple Writer glossary item to ESC W 1, the printer does not go into the double-width mode. What am I doing wrong?

A. Printer-control codes are everyone's nemesis. Your problem is the 1 in your glossary item. The BASIC code indicates that you should put a Control-A rather than a 1 in the glossary.

The BASIC function CHR\$(n) prints the ASCII character n. ASCII characters 31 and below are control codes, and you type them from the keyboard by holding the Control key down and pressing the second key.

The other problem you may be having is in entering the ESC (ASCII 27) character into Apple Writer. Normally, you can't enter ESC as a character in Apple Writer. You must bracket your printer codes with Control-Vs to indicate that the characters between the Control-Vs are to be taken as ASCII codes.

Glossary entries are not different from direct entries; they must include the Control-Vs, or Apple Writer will misinterpret the entry.

I am fairly certain your glossary item should read Control-V ESC W Control-A Control-V. To turn the double width off, use Control-V ESC W Control-@ Control-V.

To determine the correct codes for a printer, be sure you consider how the program sends the codes and make certain you enter the codes in a way the program understands. Experiment. The worst you will do is ruin a few pieces of paper. **+**

Please send your questions and problems to Rescue Squad, A+, 11 Davis Drive, Belmont, CA 94002.

ADVERTISING RATES AND INFORMATION:

Standard listings consist of a bold lead line (23 characters maximum); 7 lines of body copy (45 characters per line); 4 lines for company name, address and telephone number. \$195 per insertion—3 issue minimum. Additional charge for extra lines and company logos. Prepayment and frequency discounts available. American Express, MasterCard, Visa accepted. Copy subject to publishers approval. Send typewritten or printed copy, reproducible logo art (if applicable) and remittance to Kathryn Cumberlander, Classified Sales Manager, Ziff-Davis Publishing Company, One Park Avenue, New York, NY 10016. For additional information, assistance, or to place an order by phone, call collect (212) 503-5115.

▶APPLE III

APPLE III IS FOR ME

We have formed a central clearing house to pool Apple III software and hardware so that you, the devoted Apple III user, can conveniently locate needed products. All items are sold at substantial discounts. To order list, send \$1.00 to cover postage and handling or pick up a copy at your local AIM dealer today.
ASSOCIATION OF INDEPENDENT MICRODEALERS (AIM)
3016 N. Sterling Ave.
Peoria, IL 61604

▶BACK-UP AIDS + DISKS

EDD/COPYII +/CopyII MAC

Specialist in Backup Aids. We teach how to use them. Aid available 24 hrs per day, 7 days per wk. Everything discounted. Copy II+ & CopyII Mac—\$28.00. EDD—\$48.00. (Also—CopyII64, CopyQII, CopyWrite, CopyIIPC). Nibble Notchers—\$10.95. Good disks from .99 cents. All Applied Engineering cards—Discounted.
HOUSE OF HELP—(904) 265-4225
P.O. Drawer 190, Lynn Haven, FL 32444
"The House that never Closes." Call Voice or Modem. Voice: M-F/9-5/Modem—any other time.

▶BUSINESS OPPORTUNITIES

Personal Computer Owners
CAN EARN \$1,000 TO \$5,000
monthly selling simple services performed by their computer. Work at home—in spare time. Get free list of 100 best services to offer. Write:
C.I.L.B.C.
P.O. Box 60369
San Diego, CA 92106-8369

▶HARDWARE/ COMMUNICATIONS

CABLE TV

Jerrold equipment including new Jerrold Tri-Mode System, Hamlin, SB-3, N-12 Mini-Code, Zenith, Z-Tac and more. All products enable you to pick up most cable stations. Best prices around! For information, send \$1.00 plus SASE or call (312) 434-6788.
SWENSENS ELECTRONICS
6839 So. Maplewood
Chicago, IL 60629
NO ILLINOIS ORDERS ACCEPTED!

▶HARDWARE/ PERIPHERALS

APPLE IIc INTERFACE

Now use your Apple IIc with a parallel printer. Our SP-3 receives at BAUD rates from 300 to 19200, all switch selectable. It has a 6ft. cable and connection for another printer. \$74.95 when powered by printer. \$79.95 with wall transformer, plus \$3 shipping. Dealers inquiries invited.
CNR ENGINEERING
PO Box 492
Piscataway, NJ 08854
(201) 752-0144

CP/M FOR APPLE IIc

New, two CP/M packages for Apple IIc! Z80 hardware plugs inside case, can execute Z80 and 8080 codes. Compatible with all CP/M software, guaranteed for one year. \$119 Z80 package includes CP/M 2.2 RAMDRIVE disk emulation and copy software. \$230 package includes CP/M+ (3.0) operating system.
PRECISION SOFTWARE
6514 North Fresno Street
Milwaukee, Wisconsin 53224
(414) 353-1666

STOP PAYING SO MUCH \$\$\$

Our 64K Ram Card works like the Apple Extended 80 column card. Our C/S Clock Calendar is Pro-Dos compatible and emulates Thunderclock. A 30 day money back guarantee and a one year warranty. Order both for \$109.95 or \$59.95 each + \$4.50 shipping & handling, CA res. include 6.5% sales tax. Send Check or Money Order to:
Cursor Systems
248 North Orange Ave
West Covina, CA 91790
(818) 338-3163

▶PUBLICATIONS

APPLE DMP USERS IT'S HERE

Here's the book you've been waiting for. How to program your Dot Matrix printer New 100 page manual gives all printer commands in Applesoft BASIC. Great for beginners. Detailed instructions, examples, and glossary, plus 16 ready-to-run programs. \$9.95 ppd. Money-back guarantee. FREE details. For image writer, too.
TIMBERLINE PRESS
P.O. Box 211326
Denver, CO 80221.

NEW! MINUTE MANUALS for

The Dot Matrix Printer	\$12.95
PFS: File/Report/Graph/Write	\$12.95
Apple Writer (all versions)	\$ 9.95

Learn quickly and easily basic and advanced procedures for your printer and software. Step by step instructions, many helpful hints. Send check, MO, Visa/MC + \$2 shipping to:
MinuteWare
P.O. Box 2392
Columbia, MD 21045
(301) 995-1166

▶SOFTWARE/ ACCOUNTING

BOOKKEEPING SYSTEM

Introducing HAMS™: The One Accounts Mangr. System for the Home and Small Business. RECONCILES CR. CARD STATEMENTS & Check Books Up to 100 Accounts—Any mix of: INCOME, CHECKING, SAVINGS, CASH; CREDIT, EXPENDITURES. Default entries: HELP screens; Fully audited Det'l Rpts. + X-ref Summaries; Compl User Man Unlocked; Req. 80-col IIc; 2-drives; DM Printer \$59.95 + \$2.50 Ship; NY Res. add Sales Tax.
HILDRETH SOFTWARE, INC.
Dept. AA
127 Sannita
Rochester, NY 14626

▶SOFTWARE/ BUSINESS

THE PRINT MASTER

is the COMPLETE printing disk for APPLE! Prints business (or personal) checks, mailing labels (1 or 2 across), mailing lists, addresses, envelopes and more all from file data! Has powerful sorting features, very quick set-up, menu driven throughout. Only \$34.50! Ask your dealer or write to:
SOFT-BYTE
PO Box 5701 F. Park
Dayton, OH 45405

▶SOFTWARE/ BUSINESS PROJECT MANAGEMENT

MOVE OVER PROJECT PLANNER

Turn sketchy ideas into actual projects & draw project graphs (in color), schedule & control projects, analyze alternatives with the powerful Critical Path Method. Uniquely visual & intuitive. Available for Apple II/II+/IIe/IIc. DemoKit \$10. Complete product with attractive manual \$195. VISA/MC. Dealer inquiries invited.
APPLITECH SOFTWARE, INC.
381 Harvard St.
Cambridge, MA 02183
(617) 497-8268

▶SOFTWARE/ COMMUNICATIONS

BULLETIN BOARD SOFTWARE

"A.B.B.S 5.0" the leading Apple BBS can turn your II+/e/c into an online system of unique conferences for your own business, club or hobby. Use most 300/1200 modems, & standard phone lines. Dial-up 703-471-0610 for an ABBS demo. SPRING SPECIAL: \$159—complete system. For orders VISA/MC or info, write or call:
SOFTWARE SORCERY INC.
8375 Leesburg Pike, Suite 427A
Vienna, VA 22180
(703) 471-0772

▶SOFTWARE/DEV TOOLS

6502/65C02 PROFESSIONAL DEBUGGER

Maxwell's Demon is the ultimate debugger for assembly language programs on Apple II, II+, IIe and IIc. Fully symbolic detailed screen display. Unique UNEXECUTE command backs up and restores ALL previous values. Remap memory. Breakpoint on any conditions, even ROM code. \$49.95 ppd with 110 page manual. VISA/MC.
ENHANCEWARE by Dan Paymer
91 Pioneer Place
Durang, CO 81301
(303) 259-3598

SOFTWARE/ EDUCATIONAL

TEACHERS!

THE ASSISTANT TEACHER Handles almost every aspect of test preparation, administration, grading, analysis, curving, averaging and reporting. Includes word processor, optical scanner support, much more! Extremely flexible and easy to use. Satisfaction guaranteed. \$150.00: Manual \$10.00. **OVERDRIVE COMPUTER CORPORATION** 1562 Moorings Dr. Reston, VA 22090 (703) 471-0959

SEE THE STARS

STAR TRACK displays 862 stars, 8 planets, sun and moon (4 Qtrs). View the sky from any place on earth for any date of time. Locate and identify 90 constellations. A perfect accessory for a telescope. Copyrighted for use on Apple II+, IIe, IIc (48K). Send \$34.95 (RI residents add \$2.10 sales tax) to: **Eskimo Software** 277 Turner Rd. Middletown, RI 02840

EDUCATIONAL SOFTWARE

"I thought home educational software would be dull ... but I wanted to help my child. Then I discovered your wonderful catalog with top educational software that was really fun for both of us. We really enjoy working together on our computer now. Thanks for being so knowledgeable and caring in your selections." Write or call for your own free catalog.

MY CHILD'S DESTINY
70 Grant Avenue, Dept. 1451
San Francisco, CA 94120
(415) 861-3157

STOP GRADING TESTS!

Let the **ASSISTANT TEACHER** handle that chore. It will prepare, print administer, & automatically grade your tests, & will record, curve, & analyze all of your course grades. Reports in any format! Includes word processor, optical scanner support, & much more. Only \$150. Manual alone \$10. **OVERDRIVE COMPUTER CORPORATION** 1562 Moorings Dr. Reston, VA 22090 (703) 471-0959

"MATH TRILOGY"

'ADD 'EM UP' teaches your child addition by repetition with answer correction, child's name and music. Includes graphics routines from Penguin Software's "Cat Graphics;" "MATH TEST" checks your child's progress in basics. Makes up grades and prints test. "THE MATCH GAME" pits you against the computer in a game of logic. Try to win. All on one disk. Uses II+ (64K), IIe, IIc. Ages 4 to adult. Send \$24.95 + \$1.50 P&H to:
D.R.C. SOFTWARE
P.O. Box 152
Crestline, CA 92325
(714) 338-2936

D + D SOFTWARE

D + D FLASHCARD REVIEW—Students can enter data directory from notes or text. Great for any subject. Tape or disk only \$14.95. **D + D MULTIPLE CHOICE TEST**—Up to 50 questions per test with 3 answers each. Complete printing and grading features. Disk only \$29.95. Now on 10 major home computers.
D + D SOFTWARE
Route 2—Box 47
West, MS 39192
(601) 289-6592

SOFTWARE/ ENGINEERING

BEAM ANALY. & SPRING DESIGN

Beam analysis program calculates shear, moments, reactions, slopes and deflections in beams. Price \$50.00. **Helical spring design** program for compression, extension and torsion springs. Price: \$75.00. Both packages include disk and documentation for Apple II series of computers using DOS 3.3. 48K required. **15 DAY MONEY BACK GUARANTEE.**
SYLCA CORPORATION
33-47 14 Street, Dept A
Long Island City, NY 11106

SOFTWARE/ ENTERTAINMENT

RENT SOFTWARE FOR APPLE

WE RENT and SELL a large selection of game, educational and utility programs. Club Membership costs only \$50 (Renewal \$15/yr). Rental Period 45 Days. Most Game Rentals Only \$4. No Deposits Required as long as Rentals Don't Exceed \$8. For Full Details Send \$1 to:
DELSON'S COMPUCLUB
19801 Vanowen St.
Canoga Park, Ca 91306
(818) 887-5260

WIZARDRY IV AND BEYOND

Why wait for Sir-tech? Conquer the WIZARDS today! Create your very own death-dealing dungeon w/heating pools, elevators, chutes, pits, etc. Stock it with your pet-monsters, tantalizing treasure chests, & magical armor & weapons. The first COMPLETE scenario editor ever offered to the public. Why settle for just hint sheets/books? Buy Wizards Workbench! Introductory offer: only \$34.99!! (Send check or M.O. now.)
MAGICSOFT
529 Farragut Place, Dept. A1
Danville, CA 94526
(415) 820-0711

ULTIMA IV AND BEYOND

Why wait for Lord British? Conquer the EXOGODS today! Create your very own perilous planet. Complete with mountains, oceans, lakes, towns, castles, & dungeons. Stock it with menacing monsters, merciful mortals, & devious demons. Probe Exodus from the INSIDE! Our popular "LAVALITE WORLD" scenario included FREE! Whether you want to conquer a new world or create one, Exodus Construction Set is for you! The ONLY complete U3 editor! Send \$28.50 check or MO today!
MAGICSOFT
529 Farragut Place, Dept. A1
Danville, CA 94526
(415) 820-0711

PSYCHOSPHERE

Interactive space text adventure game. Truly an experience for the enthusiast. As the puzzles are solved, an exciting story of galactic evil unfolds. The mind is essential to defeat the ancient aliens. Who are the PSYCHONIANS, THRALL, and The WATCHERS? Apple II, IIe, IIc, 64K and single disk drive. \$39.95 + \$2.00 S/H. (FL + 5% SALES TAX.)
SOFTWARE UNLIMITED
PO Box 6361
Clearwater, FL 33518
(813) 797-7815

WAR, WIZARDRY AND ULTIMA

With **Ultimore & Wizimore** adventures, boredom is over. Explore new places, fight new foes. Wiz fans have **SCARLET BROTHERHOOD**, for use w/proving grounds. **OUR ULTIMORE** adventures are famous for their creativity. Choose from **DIVIDED WORLD**, **EGYPT**, **SPACESHIP CRASH** & others. Both kinds \$20, any 3 for \$50. Free catalog!
BACKSTREET SOFTWARE
7929 Townsend Ave., Dept. A+
Des Moines, IA 50322
(515) 278-2503

ODDS CALCULATOR:

If you are dealt the 4-D, 5-D, 6-H, 7-D and 10-D in Draw Poker should you throw out the 10-D and try for a straight of the 6-H and go for a flush? This program will compute exact odds of holding this or any poker hand at the end of the second draw for any number of discards. Price—\$25.
Robert L. Nicolai
4038 N. Ninth St.
St. Louis, MO 63147
800-NICOLA1 (642-6524) in MO: 314-621-7618

WIN AT VIDEO POKER!

LAS VEGAS POKER MACHINE is a realistic simulation of video poker machines. Unique option allows you to choose the best discards. Do you split a pair of Aces for a four-flush? Put probability on your side! Use your favorite casino's pay-off rates. Machine code speed; hi-res graphics. Requires 48K Apple with a disk drive. Send \$19.95 to:
GERHARDT SOFTWARE
32600 Concord Drive, Dept. 401
Madison Heights, MI 48071
(313) 589-3049

KNIGHTS OF WIZARDRY!

Frustrated? Rookies and skilled players alike win with our system. Fully detailed maps containing all notes and information needed. \$6.00 each scenario. Master manual has secret tricks and step-by-step guidance to conquer all three scenarios, only \$15.00. All for only \$25.00.
MASTER MAZE SYSTEMS
P.O. Box 12867 Dept A+
Gastonia, NC 28053-6867

SOFTWARE/ GENERAL

SOFTWARE EMPORIUM!

3 big reasons to buy software from Soft Source-R Inc.
1. Top Apple Programs, IBM Programs
2. Games, educational, small business (20-40% off)
3. Free shipping!
Write for free brochure. Specify computer.
THE SOFT SOURCE-R INC.
P.O. Box 2931 Dept. H
Joliet, IL 60434

LOW PRICES QUICK DELIVERY

Mocking Board A \$75 **Print Shop** \$33 **Copy II+** \$27 **Newsroom** \$35 **Microsoft Word** \$129 **Helix** \$265 **Sargon III** \$35. We carry business, Education, Recreation, & Utility programs. Request our free Education, Business or General catalog; for all 3 send \$1 for postage. We bring prices down to Earth. Call or Write:
SOFTWARE SHUTTLE
BOX 316
DAYTON, OH 45409-0316
(513) 293-2594

SOFTWARE/ HOBBIES

COIN COLLECTORS!

Unique program records entire collection and produces various reports that serve for personal investment information. Built-in market value file provides latest prices for 1600 U.S. coins. Requires 48K/1 drive/printer.
COINS software & manual \$95 (Demo Preview-pack only \$15). VISA/MC OK. Quarterly **COINS** value update diskette only \$25.
COMPU-QUOTE
6914 Berquist Avenue Suite 101A
Canoga Park, CA 91307
(818) 348-3662

SOFTWARE/ONE OF A KIND

PHOTOGRAPHERS!! PROF./AMATEURS

Having trouble keeping your studio organized? The STUDIO MANAGER helps you record and retrieve information with speed and accuracy, without the bulk of file cabinets. The STUDIO MANAGER can find your costs on film and processing, find models by any statistic, find an assistant or a stylist; keep a file of your important slides and negatives. THE STUDIO MANAGER can calibrate your exposures and save them on disk; also, keep track of your clients as they move to a new agency. The Series consists of eleven application templates, available for DB Master, Apple-Works, Apollo, PES: File and others; for Apple and IBM. Introductory offer: \$50-100 each.
Data Base Originals (DBO)
P.O. Box 468, Ossining, NY 10562
(914) 941-9336

SOFTWARE/PERSONAL

KITCHEN PLANNER

Create a 1-14 day Menu and Shopping List in less than 5 min. The only program available which both composes balanced meals and lets you change them! It's also the fastest and easiest to use. Compact, useable printout. To order send \$29.95 + \$1.50 (handling) or call with VISA/MC. All Apple II's. CA add 6 1/2%.
SAV-SOFT PRODUCTS
PO Box 24898
San Jose, Calif. 95154
(408) 978-1048

FULL SERVICE CHECKING

Relax now because your checkbook is in order! G.D.S. Checking Account System makes it easy! Know where your dollars go when you categorize checks, print/display deposits, check entries and categories. Transfer to/from category, running balance, even reconciles! Easy to use. Menu driven. Apple II+, Iie, 48K, DOS 3.3, 1-2 disk dr., Parr. Printer \$48.95. For more information or to order, write/call:
Glen David Systems Co.
PO Box 420043
Houston, TX 77242
(713) 558-1573

SOFTWARE/REAL ESTATE

PROPERTY MANAGEMENT

Software for rental income producing properties. Provides cash flow analysis, records expenditures on each unit, and accumulates cost for tax purposes. Prints cash flow report and Summary of Operations report. Provides depreciation and amortization schedules and print outs of each report.
TOMAR PRODUCTIONS
P.O. Box 740871, Dept. A
Dallas, TX 75374
(214) 750-1212

SOFTWARE/SCIENTIFIC

STATISTICAL ANALYSIS

AIDA: Apple Interactive Data Analysis. For professional survey or other statistical research. Full range of analysis, from descriptive stats through multiple regression. Handles data transformation, weighting, missing data. Up to 4,000 cases and 254 variables per file. DOS 3.3 and SOS versions. \$235.
ACTION-RESEARCH N.W.
11442 Marine View Dr., SW
Seattle, WA 98148
(206) 241-1645

SOFTWARE/SECURITY

PROTECT YOUR PRODUCTS

SENTRY is a sophisticated easy-to-use disk duplicating system that provides both effective "in memory" protection and state-of-the-art protection against unauthorized nibble copy programs. If the end user tries to interrupt the protected program with RESET or CONTROL-C with the intention of listing, cataloging, or saving, then the protected program is automatically cleared from memory before it can be "captured." SENTRY includes a manual with programming suggestions to increase security. (List price \$250). Requires: Apple's DOS 3.3 operating system, 48K RAM, two disk drives.
SENSIBLE SOFTWARE, INC.
210 S. Woodward, Suite 229
Birmingham, MI 48011
(313) 258-5566

SOFTWARE/SOPHISTICATED RECREATION

FOOTBALL TRAX

Compete with your friends and co-workers by predicting the outcome of Professional Football games. System includes Data Entry, Summary, WTD and YTD Player Standings. 48K Apple II+/IIB/IIC, 1 disk, and printer required. Priced at \$34.95 includes shipping. Send check or money order to:
SMS ENTERPRISES
1580 Windjammer
Hanover Park, IL 60103-624
(312) 830-1509

SOFTWARE/STRATEGIC GAMES

SUPER STAR TREK

You've seen it on mainframes! All the thrills of the original Star Trek plus: Romulans equipped with cloaking devices, Klingon Commanders with tractor beams, orbit planets, mine dillithium crystals, launch probes, defend starbases, five levels of play and much more! Not copy protected. Only \$19.95.
SOFTTREK ENTERPRISES
3646 Fieldcrest Drive, Dept A+
Garland, TX 75042

SOFTWARE/WORD PROCESSING

DON LANCASTER'S TOOLKITS

Sixteen disk sides chock full of APPLE-WRITER™ goodies: patches-source-code—microjustify—proportional space—disassembly script—answers—two columns—keyword indexing—space on disk—self-prompting glossaries—bonus book—bunches more. DOS 3.3 or ProDOS kits, \$39.50 each, \$59.50 for both.
SYNERGETICS
Box 809-A+
Thatcher, AZ 85552
VISA/MC ACCEPTED
(602) 428-4073

I CAN DO FOOTNOTES!!!

Harness the power of Appewriter's footnote feature with FOOTwriter. Makes papers look almost typeset. WPL program includes: (a) 3 auto footnote formats, (b) auto FN numbering, (c) popular printer glossaries, (d) help screens, (e) ProDOS calendar pre-boot. \$19.50 + \$1.00 postage. Requires Appewriter. Specify DOS 3.3 or ProDOS.
RKB SOFTWARE
1149 South 1100 East
Salt Lake City, Utah 84105
(801) 583-4383



REPRINTS AVAILABLE

Quantity reprints of articles appearing in A+ Magazine are available and will be prepared to meet any special requirements. Inquiries should be directed to Eileen Pfeiffer, Reprints Dept., Ziff-Davis Publishing Co., 1 Park Ave., New York, New York 10016. Phone 212-503-5447.



wabash
Warranted Integrity,
Incredible Value



DISKETTES

M11	5 1/4"	SINGLE SIDE SINGLE DENSITY SOFT SECTOR	90¢
M13	5 1/4"	SINGLE SIDE DOUBLE DENSITY SOFT SECTOR	\$1.00
M14	5 1/4"	DOUBLE SIDE DOUBLE DENSITY SOFT SECTOR	\$1.10

MINIMUM ORDER 20 DISKETTES
LIMITED QUANTITIES

**tremendous selection of software
books, accessories and supplies**
UP TO **50% OFF!**

Software for Apple

dBase II259	Think Tank Apple89
Multiplan Macintosh 129		Think Tank Mac89
PFS File Mac79	Wordstar189
PFS Report Mac79	Wordstar Pro Pac249

ABOVE SOFTWARE AVAILABLE IN OTHER FORMATS. CALL FOR AVAILABILITY AND PRICE.
Minimum shipping and handling \$2.00. California residents add 6% sales tax.
Prices subject to change without notice. Write for our free catalog.

ABC data products
3311 ADAMS AVE. SAN DIEGO, CA 92118
619-283-5488  **800-854-1555**

CIRCLE 605 ON READER SERVICE CARD

NEW! Lower Prices!!

wabash
lifetime warranted

DISKETTES!
\$9.80/box (10)

5 1/4" single -side, single-density; double-density
add \$2/box. Add \$3 per order shipping. In Illinois
add 7% sales tax.

Library Case-\$1.75 (with disk purchase)
Immediate shipment on VISA, MasterCard or
Money order; add 14 days for personal checks.

CALL TOLL FREE
(800) 222-1248 

In Illinois Call (312) 882-8315

DEALERS! SCHOOLS! USER GROUPS!
Call for our volume discount prices!

DIGITAL IMAGES
1185 Tower, Schaumburg IL 60195

CIRCLE 610 ON READER SERVICE CARD

**Introducing Wizard
Operating System II**

Imagine an operating system that...

- magically expands your storage area on the disk to 139K
- includes its own text editor
- is so simple the program serves as its own manual
- allows economical one sector file storage
- and does it all with one key commands

Apple II, Apple II+, Apple IIc, Apple IIe

Wizard Systems, RR 1, Box 246
Bloomfield, IN 47424
Phone — 812 825 7802

CIRCLE 603 ON READER SERVICE CARD

IIE KEYPAD



Our keypad features 4 programmable keys, 4 math function keys (+, -, /, *), and 4 cursor keys, plus delete and return. **All this for only 149.00.** Non programmable models also available for only 99.00 plus 2.50 shipping.

APPLETECH 

9817 "N" Bissonnet
Houston, Texas 77036

(713) 271-0143

CIRCLE 604 ON READER SERVICE CARD

THIS AD IS TOO SMALL

To give you more than a hint of how much we can help you be more successful with FRP games—but we'll try!

ALL WIZARDRY (R) PLAYERS NEED THE WIZSYSTEM (tm): Huge new manual with complete charts, great tips, step by step help. IBM (\$10), Apple (all 3 games \$15). SUPERIOR maps \$5 (Sc. 1, 2 or 3). All \$13.50 (IBM), \$25 (Apple). The WIZMASTER (tm) disk prints/modifies characters from all 3 games AND is but \$17.50! All above + WIZNEWS (tm) only \$47.50 (Apple), \$37.50 (IBM). Ask about Scenario 4!

ULTIMA FANS NOW HAVE QUALITY HELP with the ULTISYSTEM (tm)! Manual includes powerful tips, full charts, maps for both II and III—Only \$15! The ULTIMASTER (tm) disk alters/prints for II and III, \$17.50 (Apple, IBM, C-84). Both only \$27.50, with WIZNEWS (tm) \$35! Game IV soon!

ALL FANTASY/ADVENTURE PLAYERS NEED THE WIZNEWS (tm) quarterly! The source for news, articles, gossip, tips, interviews, reviews of your favorite computer games! Subscribe: \$10/4 issues. Sample \$3.

GAME MASTER'S GUIDES (tm) help you creatively design and run FRP games FAST! GM I: Combat tables/Dice/Random Functions/8 more Utilities AND STORAGE for 219 Monsters, 51 Characters, 51 Treasures! GM II: Generate Troops (I-20K+); Races, Tournaments, Towns, Tricks, More! GM III: Create NEW Characters and Monsters each with Name, all Stats/Items! Warning Armies, more! Disks for Apple, IBM, C-84 \$25 each, 2 for \$47.50, all 3 only \$70!

GM ADVENTURE I: RAPMORTH'S HOLLOW: Exciting new concept in computer aided group FRP games! Complete with maps and detailed manual, its creative depth, richness & ease of use will add a new dimension to your gaming enjoyment! Disk for apple, \$35. New scenarios, computers soon!

Available at quality dealers or from Nichols services. Free support! Add 5% of cost + \$1.50 for S&H to US & APO. Payment: check, MO, COD, VISA/MC (US funds only-no cash).

nichols services
6901 Buckeye Way, Columbus, GA 31904
(404) 323-9227

CIRCLE 606 ON READER SERVICE CARD

**P.F.S.* Users,
Time is Money!**

Your entire program can run
2 1/2 times faster with our
New Speedup System!

*trademark; Software Pub. Co.



PO. Box 2342
Santa Barbara, CA 93120
805 569-3132

CIRCLE 613 ON READER SERVICE CARD

**BUY DIRECT AND SAVE
FULLY APPLE COMPATIBLE**

Z-80 CP/M Card	\$48
80 Column Card w/Inverse (Videx comp)	\$68
Autolerm 80 Col w/Softswitch, Inverse (Videx comp)	\$78
Extended 80 Column w/84K Apple IIe	\$78
Disk Controller for 2 Drives	\$39
Epson Printer Card (Parallel) w/Cable	\$39
Graphic Printer Card w/Cable	\$54
Grappler + comp)	\$109
Micro Buffer Printer Graphi Card w/32K	\$54
RS232 Serial Card	\$90
Super Serial Card w/Cable & Manual	\$48
16K RAM Language Card w/Cable	\$140
128K RAM Card w/Manual & Software (Titan, Saturn Compatible)	\$68
Eprom Writer Card (2716, 2732, 2764)	\$16
Diskette Box w/Lock & Key-Holds 100	\$21
Surge Suppressor Power Center w/8 outlets	\$34
System Saver Fan w/2 outlets, lighted Switch Surge/Filter	\$10
Disk Notcher w/Guide Square Cut (Doubles Disk)	\$165
Slim Disk Drive - Direct Drive w/Elec Sensor	\$175
Super Quiet 1 yr Warranty - APPLE II/IIe	\$48
Same for APPLE IIc	
Numeric Key Pad APPLE IIe	

Shipping & Handling:
Under \$100 - 10% Over \$100 - 5%

COMPUTER SUPPLY
P.O. BOX 164A, VALLEY STREAM, NY 11582
(516) 239-1855 Hours: M-F 9-6 EST
Institutional P.O. Accepted - Dealer Inq. Invited

CIRCLE 609 ON READER SERVICE CARD

SUPER Z-80 CARD

- Compatible with all CPIM software.
- Executes Z-80, 8080, 8085 instruction sets and supports Z-80 interrupts.
- Runs on Apple II, II+ or IIe with or without an 80 column card.
- Low power consumption with fast clock.

BEST OF ALL THE PRICE IS \$89.95

SUPER RAM CARD

- 64K upgradable to 128K
- 80 col. built in
- Fully apple compatible
- Supports DOS 3.3, PASCAL, Pro Dos and CP/M
- Can be used as an electronic disk drive

Super Ram 64K upgradable —\$149.95
Super Ram 128K —\$229.95

All boards are made in the USA and carry up to a 7 year warranty C.O.D. or send check or money order to

TRICON INDUSTRIES INC.
3000 W. MacArthur Blvd. 6th Floor
Santa Ana, CA 92704
(714) 966-6711

CIRCLE 600 ON READER SERVICE CARD

**P-tral:
BASIC to Pascal
Translation Software**

P-tral is the user-friendly translation software that converts Applesoft BASIC programs to Apple Pascal.

- Translates any business, scientific, graphics and game software from source.
- Translation results approach 100%.
- Translates any sized program—Large or Small.
- Essential compile directives generated.
- PIONEER version only \$125.00.

REQUIREMENTS: 64/128K RAM, Dos 3.3
80-column card / Apple II, IIe, IIc
Apple Pascal 1.1 or 1.2

To order or request more information contact: **WOODCHUCK INDUSTRIES***
340 West 17th Street, New York, NY 10011
(212) 924-0576 / (212) 206-6490

CIRCLE 613 ON READER SERVICE CARD

COMING UP



Reviews:
Speaking of Graphics
Microsoft/Lotus
Double-Entry Accounting
for the Apple II

Newsroom

Education:
Exploring the Educational
Toolbox

Tutorials:
ProDos, Part V
PostScript, Part IV

Entertainment:
Batter Up!
Gemstone Warrior
Tales of Adventure

Macintosh Family:
Five Video Digitizers
MacTablet Digital
Drawing Board
Unix and the Mac
Expanding the
Apple Menu

A+ MART

**Low, Low Prices
Apple Peripherals**

48K Apple II + Compatible Computer	\$350.00
64K Dual CPU Apple II + Compatible Computer	\$415.00
Computer Case & Keyboard W/Num Keypad	\$110.00
5A Switching Power Supply	\$55.00
80-Column Card W/Softswitch & Inverse	\$73.00
Extended 80-Col For Iie (64K)	\$73.00
Z-80 CP/M Card (Softcard Compatible)	\$49.00
Parallel Graphics Printer Card W/Cable	\$56.00
Super Serial Card	\$95.00
16K RAM Card	\$39.00
Disk Controller	\$37.50
128K RAM Card	\$115.00
Slim Line Disk Drive	\$135.00
High Quality Joystick	\$15.95
Dot Matrix Printer, 80cps, Form/Tractor Feed	\$195.00

**WRITE OR CALL FOR OUR
COMPLETE PRODUCT LISTING**

BETTER PRODUCTS, INC.

765 S. State College Blvd., Suite E
Fullerton, CA 92631

Tel: (714) 526-7923

Add 5% of Total Purchase or \$2.00 Min. whichever is higher for shipping and insurance. Calif. residents, add 6% sales tax.

CIRCLE 601 ON READER SERVICE CARD

SONY
3 1/2"

MICRO DISKETTES

Single Side \$3.60
Double Side \$4.85

Shipping and Handling \$3.00

ILL. RES.

Add 7 SALES TAX



INFORMATION AND INQUIRIES

1-(800) FLOPPY 3

Phone for our 100+ Price

SONY is a registered trademark of SONY Corporation

APPLEWORKS

EXPANDED ON THE II +

PLUS-WORKS-XM is the first patch program that allows you to run Appleworks on your II, II+, franklin or compatible with expanded memory.

FEATURES

1. All appleworks functions available from keyboard
2. No expensive hardware to buy. Supports most 80col cards (videx, franklin, viewmax, ultraterm and more)
3. One time configuration, no preboot required.
4. Supports most popular ram cards (Legend, Saturn, etc.-XM version only)

PLUS-WORKS-XM—\$49.95 + \$3.00 ship/hand. Requires 64K Apple II or compatible and ram card. maximum desktop is 72K with a 64K ram card.

PLUS-WORKS—\$19.95 + \$3.00 ship/hand. Maximum 10K desktop, no ram card required. \$30.00 to upgrade to XM version at a later date.

NORWICH DATA SERVICES LTD.

PO BOX 356
EAST NORWICH, NY 11732-0356
(516) 922-9584

N.Y.S. Residents add sales tax

Dealers inquiries invited

MC/Visa

CIRCLE 612 ON READER SERVICE CARD

**BUSINESS
CORRESPONDENCE**

- Generate Form Letters
- Create and Edit Mailing Lists
- Address Envelopes
- Print Mailing Labels
- Convert Forms or

Apple Works or Quick File

— all with COMPANION, the best accessory program for Apple Writer. Menu-driven; perfect for small business, education, Public Relations.

Requires Apple IIc or IIe and Apple Writer program. Specify DOS3.3 or ProDOS version. \$29.95 plus \$2 shipping and handling. California residents add 6% tax.

Checks, VISA/MC accepted.

COMPANION software

1956 MCCOLLUM STREET
SAN LUIS OBISPO, CALIF. 93401
(805) 544-4984 — EVENINGS

NOW USE BOTH SIDES
OF YOUR DISKETTE!

**5 1/4" DISKETTE
HOLE
PUNCH**



WITH HOLE GUIDE

and EDGE GUIDE

PUNCH OUT IS ALWAYS IN THE RIGHT POSITION

Available for IMMEDIATE Shipment

only \$10.00 add \$2.00 shipping
CHECK OR MONEY ORDER

FOR OTHER THAN APPLE AND APPLE LOOK-A-LIKES—
WE HAVE A TEMPLATE TO POSITION A REGULAR
ROUND HOLE PUNCH FOR THE READ ENABLE HOLE
NEAR THE CENTER

COST— 4 for \$200

N.P.S. Inc.
Dept. A+

1138 BOXWOOD RD. JENKINTOWN PA 19046

(215) 884-6010

CIRCLE 611 ON READER SERVICE CARD

**THE
BUYERS GUIDE**

THE MASTER DIRECTORY
OF PRODUCTS FOR THE
IBM PC, PC XT, PCjr
AND MOST COMPATIBLES!

AVAILABLE AT YOUR
LOCAL NEWSSTAND AND
COMPUTER STORE.

A+

AD

INDEX

BY PRODUCT CATEGORY

ACCESSORIES

	PAGE
CARRYING CASES	
Fiberbilt	114
Southern Case	90
Prarie Power	68

DISKS	
ALF	176
Fuji	47

MISCELLANEOUS	
Cheatsheet Products	80
Computer Cover Company	141
Cortran International	18
EMCO	22
Formica	41
MEC Enterprises	139

BOOKS	
	PAGE
MacTutor	150

HARDWARE

	PAGE
DISK DRIVES/STORAGE DEVICES	
First Class Peripherals	37
General Computer	126/127
Personal Computer Peripheral Corp.	106

INTERFACE CARDS	
Applied Engineering	25, 51, 63, 91, 101
AST Research	100
Carribbean Computer Sales	58
Checkmate Technologies	34
Hanzon	119
Interactive Microware	86
Interactive Structures	82
Legend Industries	176
Ohio Kache Systems Co.	16
Orange Micro	93
Quantam Leap Technology	35
Street Electronics	5

	PAGE
Video 7	1
Videx	10

MISCELLANEOUS	
Demco Electronics	46
Kensington Microware	72
MacMemory Electronics	142
Mousetrak	134
Quoram	70
Southern California Research Group	52
Thunderware	142

MODEMS	
Hayes	151
Prometheus Products	152

MONITORS	
Thunderbird	69

PRINTERS/PRINTER ACCESSORIES	
Digital Products - C. Itoh ..	122
Epson America Inc.	6-7
NEC	71
Okidata	30-31
Texprint	56

MAIL ORDER

	PAGE
Beagle Brothers	64-65
Business Computers of Peterborough	43
Byte General	168
Coit Valley Computers	13
Comarc	138
Computer Discount of America	62
Computer Network	48
Conroy LaPointe	21
Creative Computer Products	111
Desktop Software Center ..	110
East Coast Software	87
Flashware	117
Garden of Eden	60
Hayes	102, 103
Jameco	88
JDR Microdevices	49
Kyan Software	156
Northeastern Software ..	157, 55
Pace Systems	115
PC Network	132-133
Precision Data Products	99
Programs Plus	163
Silicon Express	70
Software Discounters of America	85
Triad Software Products	24
Zimco	74

SOFTWARE

	PAGE
BUSINESS	
Advanced Logic	54
Applied Logic Systems	121
Applied Software Technology	76
Forethought	145
Funk Software	75
H & E Computronics	C-2
Public Domain	176
Real Data	150
Russ Systems	40
Software Publishing Corp.	44
Tardis	146

COMMUNICATIONS	
Data Viz.	140
Softronic	92

DATA MANAGEMENT	
P/M Software	77
Softwest Programming	98

DEVELOPMENT SYSTEMS	
Hippopotamus Software ..	156
Manx Software Systems ..	118

ENTERTAINMENT/STRATEGY	
Aegis Development	130
CrystalWare	159
Origin Systems	125
Marathon Software	53
Penguin Software	8
Sir-Tech	96
Spectrum Holobyte	120
Sublogic	4
Softlore	95
Videx	118

FINANCIAL	
Core Concepts	61

GRAPHICS	
Innovative Data Design	147
PBI	C-4, 154, 155
Spectralgraphics	176, 20

	PAGE
LANGUAGES	
Expertelligence	131

MISCELLANEOUS	
Compucrafts	62
Disk of the Month Club	104
Foresight Designs	144
Microsoft	112-113
Professor Jones	86
Softkey Publishing	50
Statsoft	104
T.M.Q. Software	134

ON-LINE SERVICES	
Compuserve	83
Electronic University	12

PERSONAL BUSINESS-HOME	
Chase Manhattan	36
HowardSoft	C-3

UTILITIES	
Central Point Software	46
Pro/Pac	99
Utilico	161
Vilberg Brothers	62

WORD PROCESSING/SPELLING CHECKERS	
Batteries Included	78
Companion Software	35
Sensible Software	19, 54

ALPHABETICAL AD INDEX

READER SERVICE NO. PAGE

A

- 117 Advanced Logic Systems 42
- 118 Advanced Logic Systems 54
- 317 Aegis Development 130
- * ALF Products 176
- * Applied Engineering 25
- * Applied Engineering 51
- * Applied Engineering 63
- * Applied Engineering 91
- * Applied Engineering 101
- 176 Applied Logic Systems 121
- 123 Applied Software Technology 76
- 323 AST Research 100

B

- * Batteries Included 78
- 249 Beagle Brothers 64-65
- * Business Computers of Petersburg 43
- 306 Byte General 168

C

- 296 C. Itoh Digital Products 122
- 149 Caribbean Computer Sales, Inc. 58
- 184 Central Point Software 111
- 185 Central Point Software 46
- 179 Chase Manhattan 36
- 138 Cheatsheet Products 80
- 128 Checkmate Technology 34
- 340 Coit Valley Computers 13
- 291 Comark, Inc. 138
- 303 Companion Software, Inc. 35
- 157 Compucrafts 62
- 292 CDA Computer Sales 62
- 271 Compuserve 83
- 163 Computer Cover Co. 141
- 137 Computer Network 48
- 129 Conroy-La Pointe and Computer Exchange 21

READER SERVICE NO. PAGE

- 236 Core Concepts 61
- 131 Creative Computer Company 111
- 213 Crystalware Corporation 159

D

- 333 Dataviz, Inc. 140
- 171 Demco Electronics 46
- 151 Desktop Software Center 110
- 219 Disk of The Month Club 104

E

- 329 East Coast Software 87
- 301 Electronic University 12
- 239 EMCO 22
- 316 Epson America Inc. 6-7
- 278 Expertelligence 131

F

- 159 Fiberbilt 114
- 104 First Class Peripherals 37
- 105 First Class Peripherals 37
- 289 Flashware 117
- 204 Foresight Designs 144
- 127 Forethought, Inc. 145
- * Formica 41
- * Fuji 47
- 154 Funk Software 75

G

- 262 Garden of Eden 60
- 322 General Computer 126-127

H

- * H & E Computronics C-2
- 206 Hanzon 119
- 216 Hanzon 119
- 130 Hayes Microcomputer Products Inc. 102-103
- 217 Hayes Microcomputer Products Inc. 151
- 197 Hippopotamus Software 156
- * HowardSoft C-3

I

- 112 Innovative Data Design, Inc. 147
- 144 Interactive Microware 86
- 274 Interactive Structures 82

READER SERVICE NO. PAGE

J

- 279 Jameco Electronics 88
- 167 JDR Microdevices 49

K

- 134 Kensington Microware 72
- 161 Kyan Software 156

L

- 287 Legend Industries 176

M

- 348 MacTutor 150
- 132 MacMemory Electronics 140
- 189 Manx Software Systems 118
- 293 Marathon Software 53
- 147 MEC Enterprises 139
- 115 Micro City 115
- * Microsoft 112-113
- 339 Mousetrak 134

N

- 294 NEC Information Systems, Inc. 71
- 263 Nibble Notch 18
- 330 Northeastern Software 55
- 304 Northeastern Software 157

O

- 178 Ohio Kashe Systems 16
- 240 Okidata Corporation 30-31
- 252 Orange Micro 93
- 145 Origin Systems 125

P

- 140 PBI Software 155
- 143 PBI Software 154
- 241 PBI Software C-4
- 315 PC Network 132-133
- * Penguin Software 8
- 224 Personal Computer Peripheral Corporation 106
- 150 PM Software 77
- 302 Prairie Power Systems 68
- 228 Precision Data Products 99
- 148 Professor Jones 86
- 299 Program Plus 163
- 122 Prometheus Products 152
- 165 Pro/Pac 99
- 318 Public Domain 176

READER SERVICE NO. PAGE

Q

- 139 Quadram Corporation 84
- 220 Quantum Leap Technologies 35
- 223 Quorum International Unlimited 70

R

- 342 Real Data 150
- 344 Russ Systems 40

S

- 345 Sensible Software 54
- 173 Sensible Software 19
- 231 Silicon Express 70
- 260 Sir Tech 96
- 343 Softkey Publishing 50
- 238 Softlore Corporation 95
- 164 Softronics 92
- 155 Software Discounters of America 85
- * Software Publishing Corporation 44
- 121 Softwest Programming 98
- 246 Southern California Research Group 52
- 120 Southern Case 90
- 109 Spectralgraphics Software 20
- 107 Spectralgraphics Software 176
- 233 Spectrum Holobyte 120
- 207 Statsoft 104
- 187 Street Electronics 5
- 110 Sublogic 4

T

- 215 Tardis 146
- 301 Telelearning 12
- * Texprint 56
- 305 Thunderbird 69
- 284 Thunderware 142
- 169 TMQ Software 134
- 119 Triad Software Products 24

U

- 190 Utilico Software 161

V

- 195 Video-7 1
- 146 Videx, Inc. 10
- 244 Vilberg Brothers Computing, Inc. 62

Z

- 349 Zimco 74

The Legend E' Card For Your Apple //e

**64K to 1 Megabyte
RGB Video
16 Levels of Gray Video
730K Appleworks Desk Top**

NOW ALL ON ONE CARD!!!

Turning Apples into Legends since 1981.

CALL or WRITE:

LEGEND INDUSTRIES, INC.
2220 Scott Lake Rd.
Pontiac, MI 48054
(313) 674-0953

CIRCLE 287 ON READER SERVICE CARD

DISK COPYING

Whether you need 50 disks or thousands, we have years of experience in creating the highest quality copies. Reasonable prices—fast turnaround. Call today for our free booklet on software duplication and packaging.

BLANK DISKS

Can you tell a good disk from a great one? We can, because we copy thousands each day. We'll tell you which brand is best for your system. Call today—and get great prices, too!

Call ALF first
1-800-321-4668

in Colorado (303) 234-0871

ALF

ALF Products • Denver, CO

Software for Pennies

Thousands of public domain software programs that you can freely copy for the Apple II/III/c and compatibles—are listed, described, and conveniently grouped by subject.

The Best of
APPLE
PUBLIC DOMAIN
SOFTWARE



MAIL COUPON OR CALL TODAY

- | | |
|--|----------------|
| <input type="checkbox"/> Set of 5 introductory disks plus book (includes business, home management, education, utilities, games) | \$29.95 |
| <input type="checkbox"/> Set of 3 tutorial disks (tips on Applesoft, Integer BASIC, and machine language programming) | \$15.00 |
| <input type="checkbox"/> Set of 3 business disks (database, check balancer, label maker, financial programs) | \$15.00 |
| <input type="checkbox"/> Set of 5 utility disks (disk check, disk copier, text file editor, memory dump, file recovery) | \$25.00 |
| <input type="checkbox"/> Set of 5 education disks (reading, spelling, math, history, typing, geography) | \$25.00 |
| <input type="checkbox"/> Set of 3 game disks (Boggle, chess, roulette, Towers of Hanoi) | \$15.00 |
| <input type="checkbox"/> Set of 5 Eamon adventure disks (Master and 4 popular adventures) | \$25.00 |
| <input type="checkbox"/> Book: "The Best of Apple Public Domain Software" (plus \$1.50 postage) | \$6.95 |

Include \$4 shipping and handling for disk orders. CA residents include sales tax. Please enclose payment with order: () check () VISA () MasterCard

Card No. _____ Exp. Date _____

Ship To: _____ **The Public Domain Exchange**
673 Hermitage Place, Suite 5
San Jose, CA 95134
(408) 942-0309

CurvePlotter!

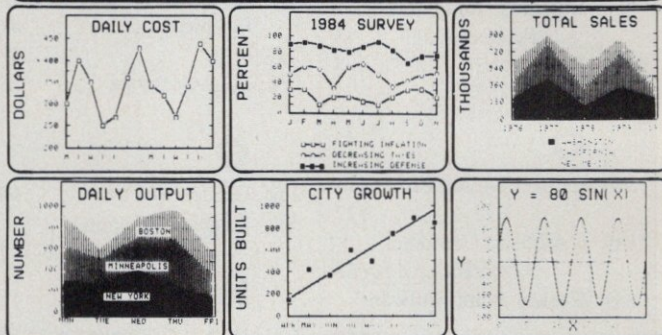

ONLY \$29.95! Don't pay more for less! For APPLE II+//IIe//IIc//III and APPLE-compatible. CurvePlotter! is an extremely sophisticated chart program. It plots line charts, area charts, best-fit trend charts, and mathematical functions. Up to 100 keyboard-entered data points may be entered, stored to disk, and plotted on screen or printer. Data may be edited at any time. All labelling and scaling is automatic or user-defined. The LINE CHART, AREA CHART, and TREND CHART programs permit numerical entry versus month, year, day, or any other horizontal label the user wishes. These programs also permit entry of x-y numerical data pairs, which is perfectly suited for scientific work. The TREND CHART program is an indispensable business and scientific tool. It finds the "best fit" to a set of data, and then draws the best straight line among the data. Also on the CurvePlotter! disk is our unsurpassed SCIENCE/MATH CHART program. Just type in any mathematical function you can think of and this program will plot it!

Send a check or purchase order for \$29.95 to SPECTRAL GRAPHICS SOFTWARE, 6333 Pacific Avenue, Suite 256-A, Stockton, California 95207. We ship immediately! Satisfaction or your money will be immediately refunded (really). Call (209) 474-1212 for C.O.D. orders. CurvePlotter! is not sold in most stores.

CIRCLE 107 ON READER SERVICE CARD

Investment decisions just got easier.

Complimentary
Tax Preparer

HowardSoft's Real Estate Analyzer™ has been helping knowledgeable investors make tough decisions since it was introduced in 1980.

Now, the Third Edition makes the process even easier.

The new version runs faster and more automatically. Entering data and formatting reports are now even more flexible. We've added more loan, depreciation, and expense models to an already impressive list. More turn-on-investment variations. Expanded tax analysis capabilities, including the effects of the Tax Reform Act of 1984, and proposed 1985 rulings. The Third Edition even handles up to 30-year analyses, instead of just ten.

At \$295 (\$350 for the IBM version) the new Real Estate Analyzer is a superb investment by itself. But there's more.

A very special offer.

To celebrate the new release, we're including a complimentary copy of the Number One selling tax software, Tax Preparer™ at no additional cost. You save over \$250.

Tax Preparer lets you enter data all year long to plan the tax effects of *all* your investments. Then, at tax time, the inexpensive update will let you apply that data to the 1985 tax forms in a matter of minutes. Finally, at the touch of a key, Tax Preparer will deliver error-free printouts, ready to sign and drop in the mail.

Both programs work with either the Apple II series, the IBM-PC, or a broad range of PC compatibles.

He who hesitates is lost.

Needless to say, we can't keep this offer up indefinitely. It's good only while supplies last.

But the wise investor will make his decision now. So he can make the rest of his decisions easier than ever.

HowardSoft™
The software investment
you can count on.

*The complimentary package included in this offer is the 1985 Edition for use in preparing 1984 tax returns, and for planning throughout 1985. To produce IRS-accepted 1985 returns, you will have to purchase an update at the start of next tax season. The update will be available directly from HowardSoft for under \$100.



8008 Girard Avenue, Suite 310,
La Jolla, CA 92037 • (619) 454-0121

While you and AppleWorks® are tackling the big jobs, who's handling the details? Introducing *Jeeves*™



THE AFFORDABLE PERSONAL ASSISTANT THAT LETS YOU AND APPLEWORKS WORK EVEN HARDER.

Sure, you and AppleWorks can tackle some pretty big problems. But what about life's little details? The phone calls. The appointments. The daily financial decisions. The mental notes.

Leave it to Jeeves, the first software program of its kind for the Apple//c and //e.

This new program from PBI works with AppleWorks to keep your life running as smoothly as your business.

Need to know what day your mother's birthday falls on? If you're free for lunch next Tuesday? What your insurance is costing per day? Or where you put the note you wrote to yourself this morning?

Leave it to Jeeves.

For only \$49.95. (Not copy-protected.)

AppleWorks is a registered trademark of Apple Computer, Inc. Jeeves and DeskWorks are trademarks of PBI Software.

Jeeves not only provides you with instant access to five valuable desk organizers. It does it without

APPOINTMENT CALENDAR. Use arrow keys to scroll month-by-month up to the year 2000.

PHONEDIALER WITH DIRECTORY. With modem, automatically dials phone numbers from directory including long distance access codes.

FOUR-FUNCTION CALCULATOR. Two-line equation and result display shows chain calculations, lets you check entries and easily make corrections, deletions and substitutions.

MEMO PAD. A page for quick note taking.

SOFTWARE ALARM CLOCK. Time displayed on demand. Time and date stamp your files with or without a hardware clock.

interfering with your work. One key-stroke suspends your AppleWorks program and gives you immediate access to an appointment calendar, phonedialer with directory, four-function calculator, memo pad or soft-

ware alarm clock. Another key-stroke and you're right back where you were.

So now when you sit down to work with AppleWorks, you can concentrate on your work. As for the rest, leave it to Jeeves. The affordable personal assistant.

To order, call 800-843-5722; in California, call 800-572-2746 9am-5pm PST. VISA, MC and personal checks accepted. No COD's please. Add \$3.00 shipping per order. CA residents add \$3.25 sales tax for each copy ordered. For use with AppleWorks versions 1.1 and 1.2 on Apple//c or enhanced //e (requires Mousecard™, AST Multi I/O™ or Thunderclock™.)

Jeeves is a PBI DeskWorks™ series product. For more information on other DeskWorks products for your Apple, call (415) 349-8765 or write to us at the address below.

PBI Software
A SUBSIDIARY OF ITAT, INC.

1155B-H Chess Drive, Foster City, CA 94404