

\$2.95

# A

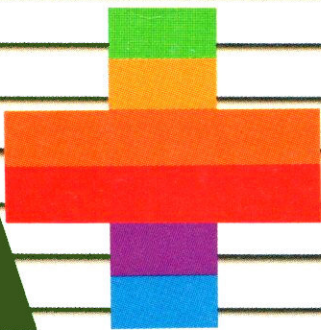

JULY 1985

VOLUME 3  
ISSUE 7

INCLUDING  
**MACINTOSH**  
COVERAGE

PUBLIC-DOMAIN SOFTWARE

MICROSOFT BASIC TUTORIAL

THE NEW FINDER

MACFORTH

THE INDEPENDENT GUIDE  
FOR **APPLE** COMPUTING

▶ **Exploring**

# AppleWorks

**How To Get More  
Out Of This  
Best-Selling Program**

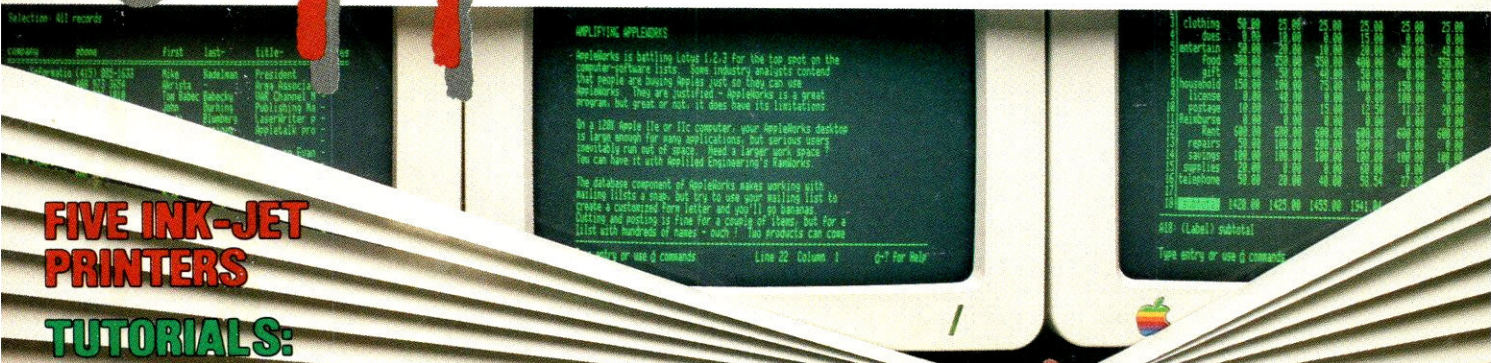

**FIVE INK-JET  
PRINTERS**

**TUTORIALS:  
ProDOS  
POSTSCRIPT**

**ENTERTAINMENT:  
USADVENTURES  
CYBORG  
SOLO FLIGHT**



Downloaded from [www.Apple2Online.com](http://www.Apple2Online.com)

# Introducing the Most Powerful Business Software Ever!

TRS-80™ (Model I, II, III, or 16) • APPLE™ • IBM™ • OSBORNE™ • CP/M™ • XEROX™



## The VERSABUSINESS™ Series

Each VERSABUSINESS module can be purchased and used independently, or can be linked in any combination to form a complete, coordinated business system.

### VERSARECEIVABLES™

**\$99.95**

VERSARECEIVABLES™ is a complete menu-driven accounts receivable, invoicing, and monthly statement-generating system. It keeps track of all information related to who owes you or your company money, and can provide automatic billing for past due accounts. VERSARECEIVABLES™ prints all necessary statements, invoices, and summary reports and can be linked with VERSALEDGER II™ and VERSAINVENTORY™.

### VERSAPAYABLES™

**\$99.95**

VERSAPAYABLES™ is designed to keep track of current and aged payables, keeping you in touch with all information regarding how much money your company owes, and to whom. VERSAPAYABLES™ maintains a complete record on each vendor, prints checks, check registers, vouchers, transaction reports, aged payables reports, vendor reports, and more. With VERSAPAYABLES™, you can even let your computer automatically select which vouchers are to be paid.

### VERSAPAYROLL™

**\$99.95**

VERSAPAYROLL™ is a powerful and sophisticated, but easy to use payroll system that keeps track of all government-required payroll information. Complete employee records are maintained, and all necessary payroll calculations are performed automatically, with totals displayed on screen for operator approval. A payroll can be run totally, automatically, or the operator can intervene to prevent a check from being printed, or to alter information on it. If desired, totals may be posted to the VERSALEDGER II™ system.

### VERSAINVENTORY™

**\$99.95**

VERSAINVENTORY™ is a complete inventory control system that gives you instant access to data on any item. VERSAINVENTORY™ keeps track of all information related to what items are in stock, out of stock, on backorder, etc., stores sales and pricing data, alerts you when an item falls below a preset reorder point, and allows you to enter and print invoices directly or to link with the VERSARECEIVABLES™ system. VERSAINVENTORY™ prints all needed inventory listings, reports of items below reorder point, inventory value reports, period and year-to-date sales reports, price lists, inventory checklists, etc.

### VERSALEDGER II™

**\$149.95**

VERSALEDGER II™ is a complete accounting system that grows as your business grows. VERSALEDGER II™ can be used as a simple personal checkbook register, expanded to a small business bookkeeping system or developed into a large corporate general ledger system **without any additional software.**

- VERSALEDGER II™ gives you almost unlimited storage capacity (300 to 10,000 entries per month, depending on the system),
- stores all check and general ledger information forever,
- stores tractor-feed checks,
- handles multiple checkbooks and general ledgers,
- prints 17 customized accounting reports including check registers, balance sheets, income statements, transaction reports, account listings, etc.

VERSALEDGER II™ comes with a professionally-written 160 page manual designed for first-time users. The VERSALEDGER II™ manual will help you become quickly familiar with VERSALEDGER II™, using complete sample data files supplied on diskette and more than 50 pages of sample printouts.

### SATISFACTION GUARANTEED!

Every VERSABUSINESS™ module is guaranteed to outperform all other competitive systems, and at a fraction of their cost. If you are not satisfied with any VERSABUSINESS™ module, you may return it within 30 days for a refund. Manuals for any VERSABUSINESS™ module may be purchased for \$25 each, credited toward a later purchase of that module.

To Order:

**Write or call Toll-free (800) 431-2818**  
(N.Y.S. residents call 914-425-1535)

- \* add \$3 for shipping in UPS areas
- \* add \$4 for C.O.D. or non-UPS areas

- \* add \$5 to CANADA or MEXICO
- \* add proper postage elsewhere



DEALER INQUIRIES WELCOME

All prices and specifications subject to change / Delivery subject to availability.

# COMPUTRONICS

50 N. PASCACK ROAD, SPRING VALLEY, N.Y. 10977

\* TRS-80 is a trademark of the Radio Shack Division of Tandy Corp. \* APPLE is a trademark of Apple Corp. \* IBM is a trademark of IBM Corp. \* OSBORNE is a trademark of Osborne Corp. \* CP/M is a trademark of Digital Research. \* XEROX is a trademark of Xerox Corp.

# INTERMISSION FOR THE SERIOUS VIEWER

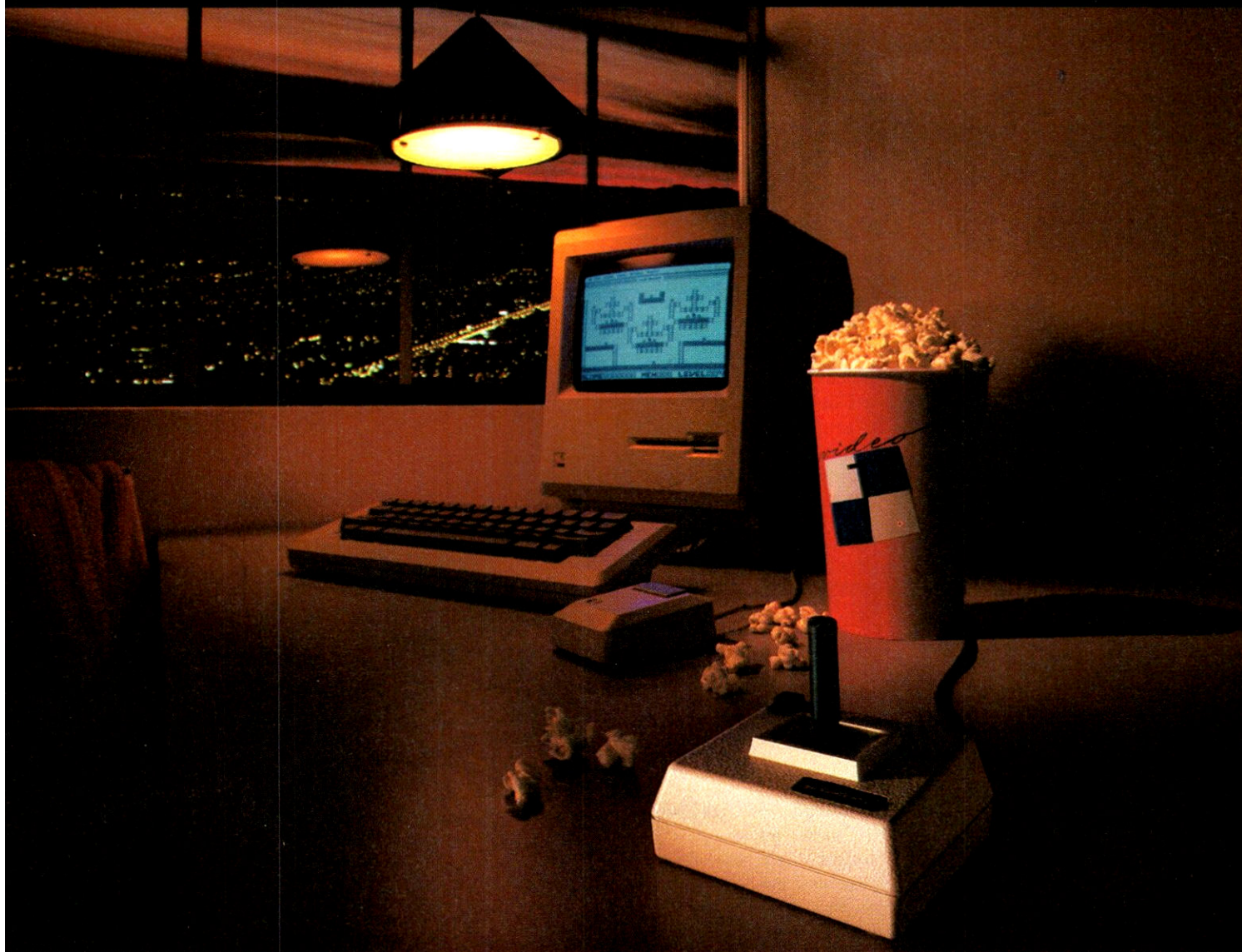

#### MouseStick

Break the routine. Give your serious side time off. All without leaving your desk. With MouseStick™ from Video 7™

#### Mastery from the masters

MouseStick is the *original* joystick for the Macintosh™. And it's from Video 7, masters of video enhancements for Apple™ computers.

#### Friend, not foe

MouseStick works with any software on any size Macintosh. It's armed with a dual plug, so mouse and MouseStick take you from office to castle and back, without even flipping a switch.

CIRCLE 183 ON READER SERVICE CARD

#### Escape with MouseStick

So get MouseStick for your Macintosh. And give your serious side a break. Mousestick. From Video 7.

Call for the dealer nearest you: (800) 238-0101, in California, (408) 943-0101.

MouseStick includes a joystick and the MouseStick interface which is compatible with any Atari-type joystick. MouseStick is a trademark of Video 7 Inc. Apple is a registered trademark of Apple Computer Inc. Macintosh is a trademark licensed to Apple Computer Inc.



# A+

THE INDEPENDENT  
GUIDE FOR  
APPLE COMPUTING

PAGE 28

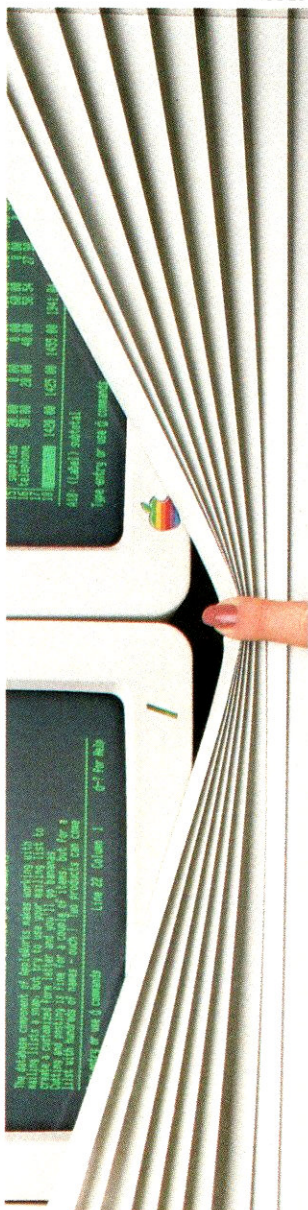

COVER PHOTO: DOW/CLEMENT CALLIGRAPHY: WILLIAM STEWART

**COVER STORY**

**28**  
**INTRODUCTION**  
By the Editors

**30**  
**AMPLIFYING  
APPLEWORKS**  
By Michael Callery  
A variety of add-on products lets you expand AppleWorks' capabilities.



PAGE 36

**36**  
**BUSINESS APPLEWORKS**  
By Charles Rubin  
Using a single pool of data for several purposes, from inventory analysis to salary projections



PAGE 42

**42**  
**PERSONAL APPLEWORKS**  
By Charles Rubin  
AppleWorks' spreadsheet function lets you organize and analyze your financial records.



PAGE 48

**HARDWARE**

**48**  
**MEET THE INK JETS**  
By David Townsley and Francesca Venning-Townsley  
What accessories for your Apple are uncommonly quiet, sometimes colorful, and use a high-tech squirt gun? The answer: ink-jet printers. To find out how they work and which one you should buy, read this review of four ink-jet printers.

**TUTORIAL**

**61**  
**SHAPING POSTSCRIPT TO YOUR BIDDING**  
By Steve Rosenthal  
Part II of a four-part tutorial series on the PostScript typesetting and graphics language. This month, we present some simple graphics operations you can do by giving the LaserWriter PostScript commands with an Apple II, Macintosh, or any other computer with a serial port.

**69**  
**UNDERSTANDING ProDOS**  
By Gary B. Little  
This article is the third in a five-part series about how to use ProDOS. This month we'll finish up the discussion of Applesoft disk commands by describing disk commands for programmers and then showing you how to install commands of your own creation.

**DEPARTMENTS**

**9**  
**EDITORIAL**

**11**  
**LETTERS**

**12**  
**NEWS +**  
By Frederic E. Davis  
News and views of the personal-computer industry

DEPARTMENTS, CONTINUED

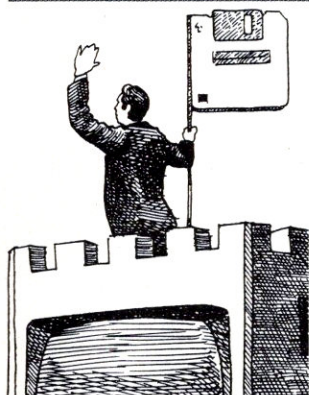

PAGE 15

**15**  
**THOUGHTWARE**

**By Steve Rosenthal**  
This month Steve Rosenthal takes a first look at a prerelease version of Microsoft's new integrated spreadsheet program for the Macintosh, Excel, which is taking aim at Lotus 1-2-3's share of the business market. This column is a must for Mac owners.

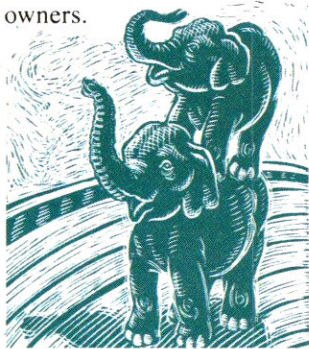

PAGE 12

**25**  
**APPLEWORDS**

**By Steve Rosenthal**  
A short glossary of terms for use with our "Exploring AppleWorks" articles, which include "Amplifying AppleWorks," "Business AppleWorks," and "Personal AppleWorks."

**83**  
**THAT'S ENTERTAINMENT**  
Reviews of Cyborg for the Mac, Karateka, Solo Flight and USAventures

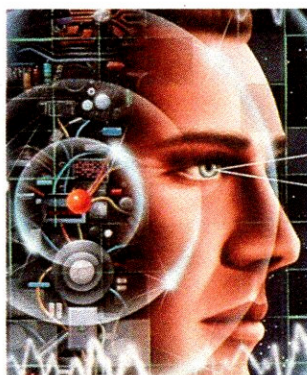

PAGE 83

**93**  
**SPEAKING OF GRAPHICS**  
**By Roberta Schwartz and Michael Callery**

Read this column for recommendations on books about graphics, what's new in the Apple double-hi-res world, how to use a Dazzle Draw file with double hi-res packages, and the latest graphics programs for the Macintosh.

**138**  
**PIPELINE**  
**By Ruth Ramberg**  
Products you want to know about—for the entire Apple-computer line.

**151**  
**COMING UP**

**159**  
**INDEX TO ADVERTISERS**

MONTHLY  
**MACINTOSH**  
COVERAGE



**100**  
**PENNY-WISE PROGRAMS, PART I**

**By Robert C. Eckhardt**  
Did you know that many interesting Macintosh programs are available for little or no cost? If not, then you haven't heard about public-domain software. To find out more about these programs, be sure to read this first part in a two-part article on public-domain software.

PAGE 100

**119**  
**BASICALLY MACINTOSH**

**By Michael Callery**  
Learn how to program your Mac in BASIC with Microsoft's Basic 2.1 and take advantage of menu bars, alert boxes, and edit boxes.

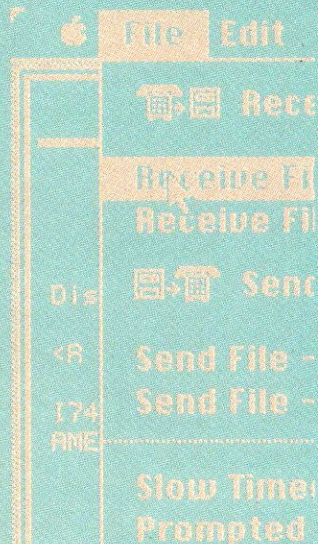

**131**  
**A LOOK AT THE NEW FINDER AND MACFORTH**

**By Thom Hogan**  
This column discusses the new version of the Mac Finder and MacForth Level 2, and we present an annotated chart of programming languages for the Macintosh.

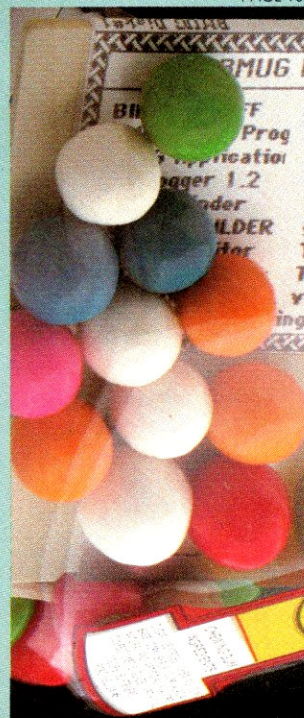

# Flight Simulator II

For Apple II,  
Apple II+, & Apple IIe

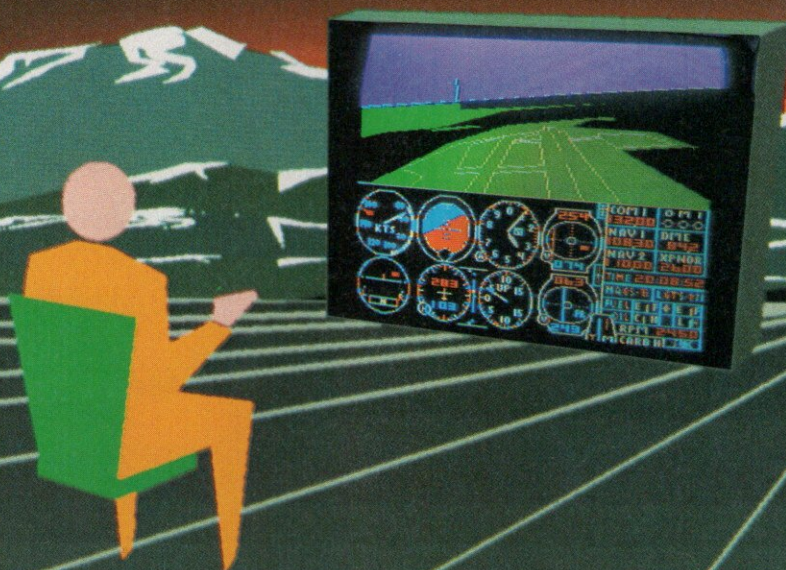

Put yourself in the pilot's seat of a Piper 181 Cherokee Archer for an awe-inspiring flight over realistic scenery from New York to Los Angeles. High speed color-filled 3D graphics will give you a beautiful panoramic view as you practice takeoffs, landings, and aerobatics. Complete documentation will get you airborne quickly even if you've never flown before. When you think you're ready, you can play the World War I Ace aerial battle game. Flight Simulator II features include ■ animated color 3D graphics ■ day, dusk, and night flying modes ■ over 80 airports in four scenery areas: New York, Chicago, Los Angeles, Seattle, with additional scenery areas available ■ user-variable weather, from clear blue skies to grey cloudy conditions ■ complete flight instrumentation ■ VOR, ILS, ADF, and DME radio equipped ■ navigation facilities and course plotting ■ World War I Ace aerial battle game ■ complete information manual and flight handbook.

**See your dealer . . .**

or for direct orders enclose \$49.95 plus \$2.00 for shipping and specify UPS or first class mail delivery. American Express, Diner's Club, MasterCard, and Visa accepted.

**Order Line: 800 / 637-4983**

**subLOGIC**  
Corporation  
713 Edgebrook Drive  
Champaign IL 61820  
(217) 359-8482 Telex: 206995



**Publisher**  
Sydney H. Rogers

**Editor**  
Maggie Canon  
**Senior Editor/Technical**  
Frederic E. Davis  
**Senior Editor/Features**  
Jane Willson

**Senior Copy Editor**  
Eva Langfeldt

**Managing Editor**  
Leslie Steere

**Copy Editor**  
Ruth Ramberg

**Office Manager**  
Marjorie Gae Brandon

**Assistant Editor**  
Candace De Santis

**Consulting Editors**  
Michael Callery, Chip Carman,  
Steve Rosenthal, Roberta Schwartz

**Contributing Editors**  
Chris Albertson, Dennis Brothers, Sue Crissman,  
Robert Cowart, W. Charles Doherty,  
Thom Hogan, Ken Landis, Russ Lockwood,  
Vanessa Schnatmeier, John W. Tripp, John Zussman

**Art Director**  
Peter A. Tucker

**Associate Art Director**  
Fabian Cooperman

**Art Assistant**  
Ac Kyung Kuark

**Mechanical Artists**  
Kyle Houbolt,  
Julie Oxberry, Dennis Norwood

Editorial Office: 11 Davis Drive, Belmont, CA 94002; (415) 598-2290  
Advertising/Business Office: Ziff-Davis Publishing Company,  
One Park Avenue, New York, NY 10016, (212) 503-5105  
Subscription Inquiries and Service: A+, P.O. Box 2965, Boulder, CO 80322,  
(303) 447-9330

**Advertising Manager**  
**Mid-Atlantic/Southeast Manager**  
**Mid-West Manager**  
**Northwest Manager**  
**Southeast Manager**  
**Advertising Coordinator**  
**Telemarketing Manager**  
**Account Representatives**

Suzanne M. Zellner  
Thomas E. Richardson  
Thomas J. Lutzke  
David J. Ezequelle  
Cynthia L. Ramsey  
Angelo M. Turco  
Cindy M. Silverman  
EAST COAST Chris M. Tice  
MID-WEST Andrew S. Dietz  
WEST COAST Leslie C. Phillip  
Timothy N. Carter  
Helen Kempisty  
Robert Woltersdorf  
Shane Boel

**Assistant to Publisher**  
**Single-Copy Sales Director**  
**Circulation Manager**

**COMPUTER PUBLICATIONS DIVISION**

**President**  
**Vice President, Editorial**  
**Vice President, Production**  
**Vice President, Licensing & Special Projects**  
**Vice President, Creative Services**  
**Vice President, Circulation**  
**Vice President, Circulation Services**  
**Vice President, Marketing Services**  
**Vice President**  
**Marketing Manager**  
**Business Manager**  
**Editorial Director**

Kenneth H. Koppel  
Jonathan D. Lazarus  
Baird Davis  
Jerry Schneider  
Herbert Stern  
Alicia Marie Ivans  
James Ramaley  
Ann Adelman  
Hugh Tietjen  
Ronnie Sonnenberg  
Gary A. Gustafson  
Ernest F. Baxter

**ZIFF DAVIS PUBLISHING COMPANY**

**President**  
**Senior Vice President**  
**Senior Vice President**  
**Vice President**  
**Treasurer**  
**Secretary**

Richard P. Friese  
Philip T. Heffernan  
Philip Sine  
William Phillips  
Selwyn Taubman  
Bertram Abrams

A+ : The Independent Guide for Apple Computing (ISSN #0740-1590) is published monthly for \$24.97 one year, \$43.97 two years, and \$57.97 three years. Additional postage \$12 for Canada, \$12 other foreign by Ziff-Davis Publishing Co., One Park Ave., New York, NY 10016. Second-Class Postage paid at New York, NY 10016 and at additional mailing offices. POSTMASTER: Send address changes to A+, P.O. Box 2965, Boulder, CO 80321.

A+ is an independent journal, not affiliated in any way with Apple Computer, Inc. Apple is a registered trademark of Apple Computer, Inc. Entire contents Copyright © 1985 Ziff-Davis Publishing Co. All rights reserved; reproduction in whole or in part without permission is prohibited. The following are trademarks of Ziff-Davis Publishing Co.: A+, A+ : The Independent Guide for Apple Computing, Rescue Squad, That's Entertainment. Permissions: Material in this publication may not be reproduced in any form without permission. Requests for permission should be directed to Jean Lamensdorf, Manager, Reprints/Rights and Permissions, Ziff-Davis Publishing Company, 1 Park Ave., New York, NY 10016. BPA membership (Selected Market Audit Division) applied for October 1983.

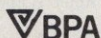

# Next-Generation Interfaces

Street Electronics introduces a new generation of Apple® interfaces that makes using printers, modems, clocks, and other peripherals easier than ever before. And, these new products are available at prices that will surprise you.

The **BusinessCard™** is an Apple II+ and IIe multifunction card with a printer and modem port, clock with battery back-up, built in graphic screen printing capabilities, and the option of up to 64k of print buffering. Purchasing the equivalent functions separately would cost well over \$500, yet the BusinessCard sells for less than \$200.

The **AlphaBits™ II** serial printer/modem interface has over 60 built in graphics and text screen printing commands and a 16-64k print buffer option. The AlphaBits II is compatible with a wide variety of printers, works with all Apple software, and sells for less than \$100.

The **LiveWire™** is an intelligent printer cable with a built in clock/calendar that connects a *parallel* printer to the *serial* port on your Apple IIc. The serial to parallel converter and clock are inside the LiveWire's unique connector – no additional hardware is needed. Also under \$100.

See your local Apple dealer.

CIRCLE 187 ON READER SERVICE CARD

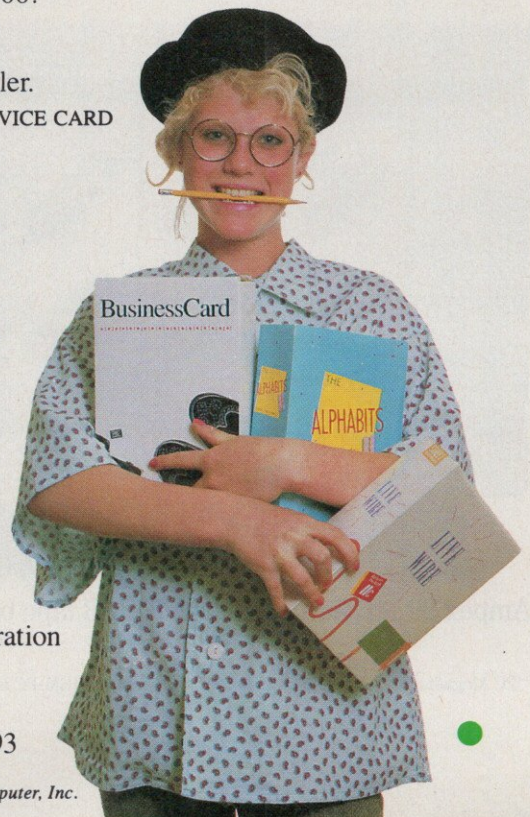

Street Electronics Corporation  
1140 Mark Avenue  
Carpinteria, CA 93013  
Telephone (805) 684-4593

Apple is a registered trademark of Apple Computer, Inc.

# In the 92 seconds it find any file you need

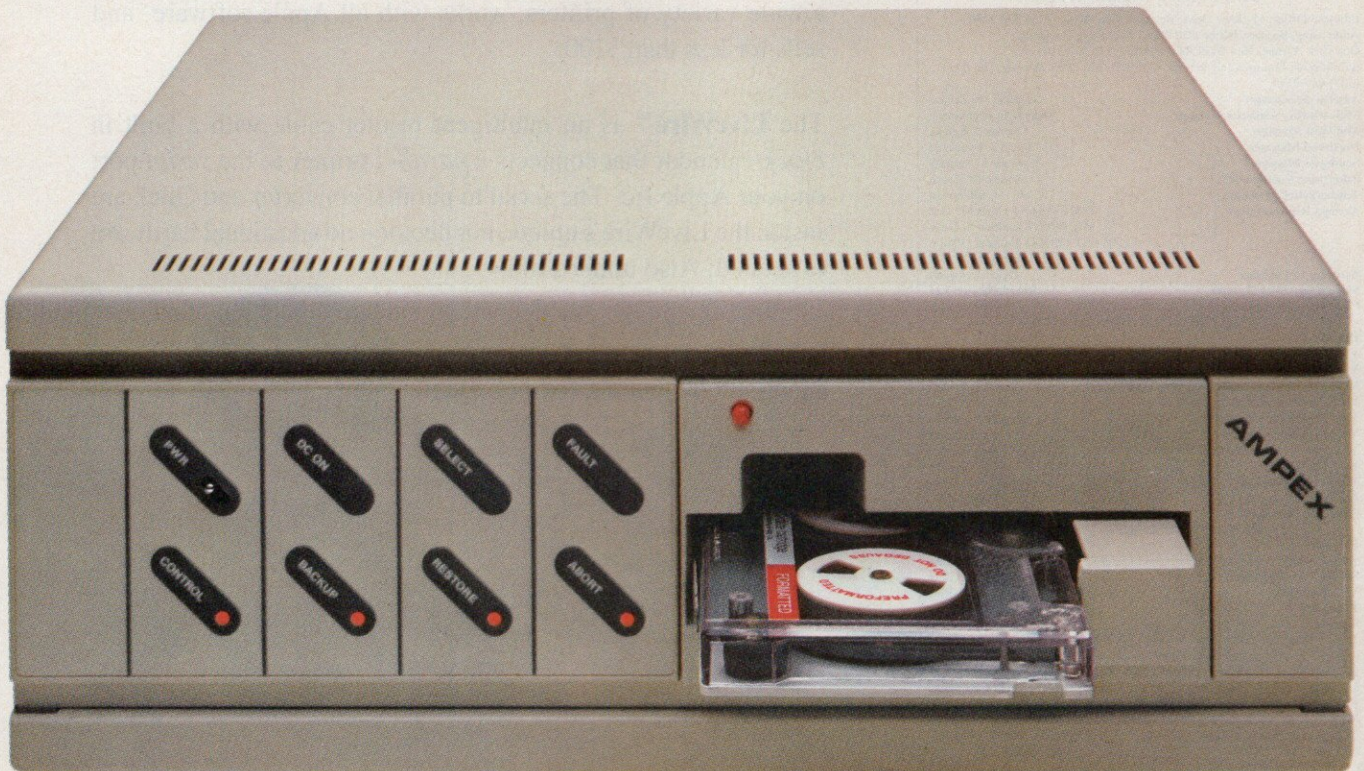

Ampex 20 MB hard disk with 25 MB tape backup.

\*PC Megastore is a trademark of Ampex Corporation. †IBM-PC is trademark of International Business Machines. ‡Apple II and IIe are trademarks of Apple Computer.



# takes to read this ad, on our backup streamer.

Ⓛ In the 1 hour, 4 minutes other streamers take, you could call your broker. Linger over coffee. Wade through the Wall Street Journal. Ⓛ And read this PC Megastore™ ad too. Ⓛ So take the time.

You'll more than make it up with a PC Megastore hard disk and tape hooked to your IBM-PC\* or compatible, Apple II or IIe† because all the files you need—both current and archive—will always be right where you need them.

Ⓛ Just a keystroke away. Ⓛ The secret? Only Ampex backs up a 20 MB hard disk with another 25 megabytes\* of addressable storage—a unique, bootable streamer with cache memory. That not only means you can address a file in 92 seconds, you can backup files offline just by touching a couple of buttons. Ⓛ Without tying up your computer. Ⓛ Your time. Ⓛ Or a small fortune in floppies. (In fact, our 45 megabytes of available storage cost about half the price per MB of other hard disks.) So consider your time, money and convenience. Ⓛ And our quality. The PC Megastore system is backed by a full year warranty from Ampex, a company known for manufacturing quality computer peripherals for over 20 years. Ⓛ Take a moment. Contact: Ampex Computer Products Division, Marketing Communications, 10435 N. Tantau Ave., Cupertino, CA 95014. 800 421-6863, 213 640-0150 in CA. We'll give you a dealer's name so you can buy a PC Megastore system. Ⓛ Then in no time at all, you'll make up for the 92 seconds you spent reading this ad.

**AMPEX**  
Ampex Corporation • One of The Signal Companies

\*PC Megastore is upgradeable and comes in four models: 20 MB with 25 MB tape, 10 or 20 MB disk, or 25 MB tape.

# YOU KNOW YOUR APPLE WORKS, BUT DOES IT WORK FOR YOU?

You've bought your Apple computer. You've gone through a few introduction disks and more than a couple of games. So now what?

Two new home productivity packages put your Apple computer to work for you. Home Data Manager and Home Connection painlessly introduce you to information management and modem use.

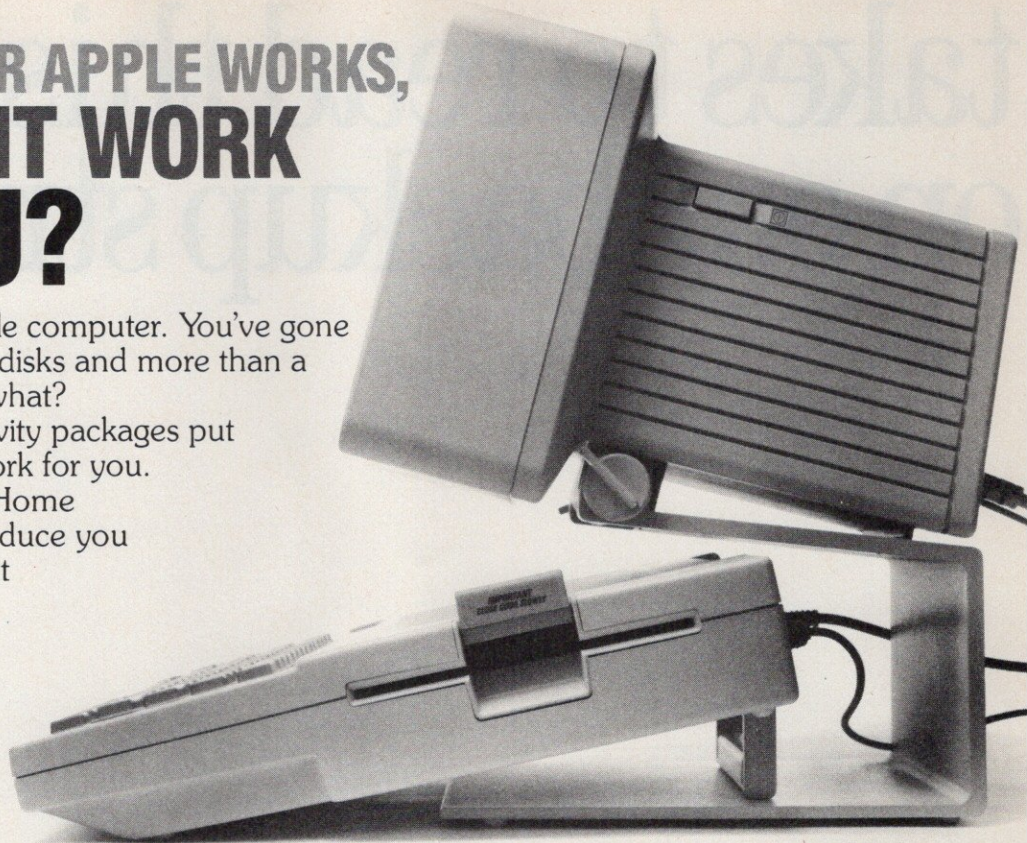

## HOME DATA MANAGER™

(by Mark Pelczarski, author of *The Graphics Magician* and *The Complete Graphics System*) is an easy to use, versatile filing program that lets you organize, file, search, sort, and print your data. And when you need to, you can even redefine your data format, or split and combine data disks. Requires 64K.

### FEATURES:

- a graphic file folder format to guide you through your information quickly and easily (choices and options are always displayed)
- plenty of power to search for items or groups of items with multiple search criteria
- creates any kind of print format you want—from labels to invoices

## HOME CONNECTION™

(by William Shaw of *microseeds*) is a home applications program that's a must for anyone with a modem. It provides you with all the necessary features of modem software in a simple to use format. Plus, the capabilities of a complex program that are easily accessible when you need them. Requires 48K.

### FEATURES:

- an editor for composing and editing copy, and a trap for recording text or data (so you can do most of your work without wasting valuable connect time)
- a transfer option for sending text or data
- autodial to be used with compatible modems
- upper/lower case display and 80-column options

For information on these, or other Penguin products, please write for a free catalog to: Dept. A, P.O. Box 311, Geneva, IL 60134

**NEW**

Penguin Software introduces a line of premium software to help you make your software choices without emptying your wallet.

# P··LARWARE™

830 Fourth Avenue, P.O. Box 311, Geneva, IL 60134 • (312) 232-1984

Apple is a trademark of Apple Computer, Inc.. Home Data Manager, Home Connection, The Graphics Magician, The Complete Graphics System, Polarware, and Penguin Software are trademarks of Penguin Software, Inc.. Penguins move in mysterious ways.

 penguin  
software™  
the graphics people

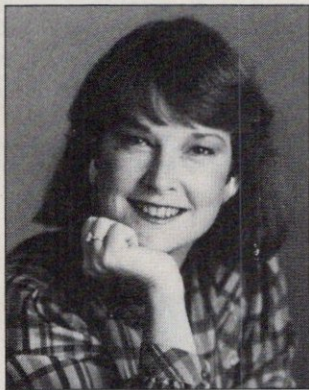

AppleWorks gains ascendancy in the software-sales charts, giving Apple a boost in the cyclical business world.

## APPLEWORKS OVERTAKES LOTUS 1-2-3

Some news crossed my desk the other day that brought a wry grin to my face, since it made me realize how cyclical business fortunes tend to be. The news was that AppleWorks had topped the software sales charts, edging out the leader, Lotus 1-2-3. For those of you who are new to computing, AppleWorks is a software product from Apple that integrates word processing, spreadsheet, and database management on the Apple II family of computers (see our three-part article in this issue, beginning on page 28). 1-2-3 is a program from Lotus Development Corporation that integrates spreadsheet, database-management, and graphics applications.

I've been in this industry for six years, which has given me a historical perspective that was the reason for my grin. You see, a long time ago, when Apple was charting the waters to bring personal computers to the general public, a company called Software Arts introduced a product called VisiCalc, which automated the process known as spreadsheet analysis. VisiCalc was truly an innovative creation and virtually an overnight success that helped propel Apple into the forefront of the fledgling personal-computer industry. Apple and VisiCalc dominated the personal-computer and spreadsheet market for quite some time.

But alas, like most things in life, business cycles come around, and one product must go down while another

comes up, which is exactly what happened. In 1981, IBM couldn't resist the siren call of the personal-computer market and invaded with the IBM Personal Computer. With a name like IBM, the product (no matter how mundane) couldn't help but do well. Then a young company called Lotus Development Corporation introduced a product for the IBM PC called 1-2-3. Like VisiCalc, 1-2-3 was a very useful product, and it helped the IBM PC take off, just as VisiCalc had propelled the Apple II. Lotus 1-2-3 climbed to the top of the software charts and stayed there.

By the time I got the news that AppleWorks had supplanted Lotus 1-2-3 as the top best-seller, I was tired of hearing about how IBM and Lotus 1-2-3 were stepping all over Apple. I was beginning to wonder if we would ever see a shift from the current stage of the spreadsheet wars. Well, AppleWorks has taken Lotus 1-2-3 by surprise and outdistanced the complacent king. An interesting aside is that VisiCalc has declined but has not disappeared—and Lotus recently purchased Software Arts, the company that created VisiCalc.

Besides making life more interesting for journalists, these business cycles have a distinct benefit: better products, which I hope will ultimately lead to truly useful and approachable computers and software. +

*Maggie Canon*

MAGGIE CANON/EDITOR

# Apple Owners: Increase your Display up to 455% and Get The Big Picture!

B18 L: COMPUTER EXPENSE														
CA	A	B	C	D	E	F	G	H	I	J	K	L	M	N
		JAN	FEB	MARCH	APRIL	MAY	JUNE	JULY	AUG	SEPT	OCT	NOV	DEC	
1														
2	BILLINGS:													
3	PRODUCT A	16987	19259	17459	21623	25928	32179	45871	21893	23769	23225	15227	18269	
4	PRODUCT B	6777	3818	5477	6888	7100	12338	15290	6375	6687	3318	8818	4537	
5	PRODUCT C	36235	32527	29892	38133	31828	31818	32688	34358	34651	36454	37818	42459	
6	TOTAL	59919	54884	52828	57844	64848	75527	93849	61826	65187	62989	68247	65265	
7														
8	CASH RECEIVED	48523	43257	45928	51433	65965	88564	96218	69835	79782	75964	73358	75788	
9														
10	CASH PAID OUT:													
11	AUTO TRAVEL	118	118	118	118	118	118	118	118	118	118	118	118	
12	INSURANCE	388	-	-	388	-	-	388	-	-	388	-	-	
13	INTEREST	1588	1588	1588	1588	1588	1588	1588	1588	1588	1588	1588	1588	
14	INVENTORY COST	41943	38363	36988	48491	45394	52869	32567	21639	22787	22846	21886	22843	
15	ENTERTAINMENT	318	318	318	318	318	318	318	318	318	318	318	318	
16	PAYROLL COST	18288	18288	18288	18288	18288	18288	18288	18288	18288	18288	18288	18288	
17	COMPUTER EXPENSE	-	-	-	-	379	-	-	-	-	-	-	-	
18	RENT	1458	1458	1458	1458	1458	1458	1458	1458	1458	1458	1458	1458	
19	TELEPHONE	588	588	588	588	588	588	588	588	588	588	588	588	
20	UTILITIES	375	375	375	375	375	375	375	375	375	375	375	375	
21														
22	TOTAL EXPENSES	56768	52888	51585	55316	68298	67394	47392	36164	37312	36871	35611	37368	
23														
24	NET CASH FLOW	-8245	-9631	-5577	-3883	5667	13178	48818	33671	42398	39893	37747	38412	
25	CASH BALANCE:													
26	BEG. OF MONTH	188888	91755	82124	76547	72665	78332	91582	148328	173991	216388	255473	293228	
27	END OF MONTH	91755	82124	76547	72665	78332	91582	148328	173991	216388	255473	293228	331632	

40-Columns

80-Columns

UltraTerm

What you see is what you get. It's an old saying, but never more true than with the limited screen displays of most computers. Too often we have to continually jump back and forth to see all the information we are working with. UltraTerm solves this problem.

UltraTerm is the best video card for the Apple IIe and standard Apple computers. Eight different screen formats allow you to tailor the display to your needs. From the 128 column by 32 rows shown above (ideal for spreadsheets), to 80 columns by 48 rows, or even 160 columns by 24 rows, UltraTerm expands your view.

Best of all, the UltraTerm is fully compatible with the Videoterm, the best selling and most widely supported 80-column card for standard Apple computers. UltraTerm is supported by many popular programs. MultiPlan, Word Juggler IIe, WordStar, FlashCalc, and SuperCalc are just a

few of the programs that support UltraTerm. Additionally, with optional pre-boots, AppleWorks, VisiCalc, and AppleWriter II can be used as well.

UltraTerm is now available in two forms: one for standard video monitors such as the Apple monitor II, and another with easy-on-the-eyes high quality character set for monitors that support interlace video (with high persistence phosphor).

**UltraTerm for standard video monitors**  
New Low Price—\$299.00

**High-Quality Character Kit — \$49.00**  
(as shown above)

SEE US AT BOOTH #4171 AT  NCC '85



1105 NE Circle Blvd., Corvallis, OR 97330  
503-758-0521  
CIRCLE 142 ON READER SERVICE CARD

► **CATALOG TIP**

Dear *A+*,

In your May 1985 issue, page 197, you answered a "Rescue Squad" question regarding printing out a catalog of files. The questioner mentioned that he was using Apple Writer IIe.

Your response was to do a catalog from the system master, which will produce a hard copy of the catalog. This solution is less than ideal, because it requires several boots of the System Master and the application program.

A more direct approach is available from within Apple Writer IIe. This method is to use the Addition Functions menu (Control 0) and its Catalog option (Option A). You are then asked for the slot and drive number. If you end your response with a #, a copy of the catalog loads into memory, and you can then print it out from within Apple Writer IIe.

This feature is noted on page 88 of the Apple Writer IIe manual.

I would like to congratulate you on the quality of your magazine. I find it to be very useful in staying abreast of the fast-changing world of Apple. We use two Apple IIe's in a business environment. I therefore find your articles on new business software, communications equipment and software, and graphic-presentation capabilities to be very informative.

Norman R. Wirtz  
Norfolk, MA

► **DON'T SHORTCHANGE IIc**

Dear *A+*,

As a leading Apple magazine, *A+* needs increased IIc coverage, both in providing articles specific to the IIc and providing directed comments within articles covering the II family.

According to *Infoworld*, the IIc took 28% of the Christmas market, compared to the IIe's 11%. In fact, the IIc sold more than the IIe and Mac combined. My Apple dealer is selling three

IIc computers for every IIe, and the gap is widening. Software and hardware support of IIc features is sure to increase with the IIc's incredible sales record.

It's clear that consumers have recognized that the IIc is not a "hacker's computer," but "the computer for the rest of us."

I hope your magazine will be in the forefront of covering, promoting, and supporting the IIc.

Robert P. Lyle, Jr.  
Baton Rouge, LA

► **MORE ON ULTRATERM**

Dear *A+*,

I own an Apple II Plus and the Videx Ultraterm 80-column card. After having read the excerpt from *The Endless Apple* by Charles Rubin in the March issue of *A+*, I would like to supply interested readers with further information on the Ultraterm, as well as a few corrections:

The Ultraterm can display 40, 80, 96, 128, 132, or 160 columns across the screen and up to 48 lines, in nine fixed combinations.

It has two complete, built-in character sets. One is a standard Apple display, and the other is a "high-quality" set, meant for use in interlace modes.

The Ultraterm supports inverse and normal characters, whose characteristics can be altered through software (via the keyboard) or through hardware (via DIP switches). Each mode can be any combination of the following: standard or high-quality character set, inverse or normal video, and highlight or lowlight (eight combinations for each mode—note that they can both be identical).

I would also like to point out that having a "slow-phosphor" monitor is hardly essential for an adequate display. My Zenith monitor works fine with the Ultraterm, and although there is indeed a slight flickering in the inter-

lace modes, it is hardly noticeable. You actually have to look for it to see it.

I hope this additional information will be helpful to those considering adding an 80-column card to their system. (By the way, I bought my Ultraterm through the mail for less than \$200! So don't let the megabucks price tag frighten you off.)

Daniel Harling  
Rockport, MA

► **III COVERAGE**

Dear *A+*,

I was very pleased to get my April issue of *A+* and see your "Apple III Software Chart."

A number of magazines are devoted to Apple computers, but I have dropped my subscriptions to several of them because of a lack of coverage of the Apple III. I am happy to continue my *A+* subscription when I see items such as yours written for the Apple III user.

Thomas John Martin  
Owings, MD

*Thank you. We do our best to cover the entire Apple product line.—Editors*

► **CORRECTIONS**

**Rama Review**

Our April 1985 review of *Rendezvous with Rama* (pages 180 and 181) incorrectly stated that the game's manufacturer, Trillium Software, was started by Baen Books. The company was, in fact, started by Spinnaker Software.

**Graphworks for Appleworks**

Our March 1985 "Rescue Squad" incorrectly stated on page 197 that no programs directly interface with AppleWorks for graphics. There is, in fact, such a program, *GraphWorks*, from PBI Software of Foster City, California, which we look at in this month's "Amplifying AppleWorks" article (see page 30). Our apologies to PBI for the error.

## ▶ APPLEWORKS FOR APPLE II AND II PLUS

Previously, the best-selling AppleWorks program could run only on an Apple IIe or IIc. Now the Apple II and II Plus can use AppleWorks, too, thanks to AppleWorks Modify, created by Videx of 80-column-card fame.

The Videx AppleWorks Modify program requires a system with 64K RAM but provides a work space of only 10K RAM, which is not a lot of memory to work with. Hopefully Videx (or some other company) will offer software that allows Apple II and II Plus users to take advantage of memory-expansion cards, such as those offered by Applied Engineering, Legend, and Titan.

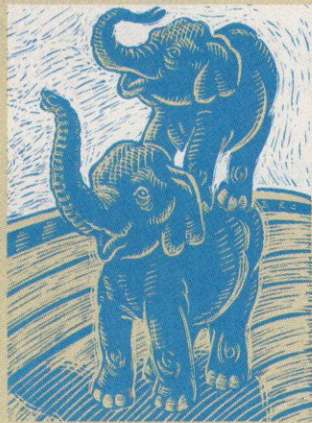

## ▶ IIe MEMORY UPGRADE

If you have a 64K Apple IIe and have been using AppleWorks, you've probably wished that you had more memory to work with. Or perhaps you want a 128K IIe so you can use double-high-resolution graphics.

Whatever your reason, if you want to upgrade your IIe to 128K, you can save some money by adding the extra memory to the 80-column card in your present IIe. You don't have to scrap the 80-column card in favor of the Extended 80-Column Card. Two companies I know of, Apricorn and Caribbean Computer Sales, offer a piggyback board with an additional 64K RAM that plugs into your existing IIe 80-column card. These cards provide an economical way to expand your IIe's memory from 64K to 128K.

## ▶ APPLE DONATES \$2 MILLION

Apple Computer, Inc., recently donated more than \$2 million worth of used Apple II Plus computer systems to the National Easter Seal Society, the world's largest volunteer organization, which provides rehabilitation services to people with disabilities. The computers are to be used to help people with learning disorders, communication impairments, mobility limitations, vision problems, and other disabilities.

John Garrison, executive director of the National Easter Seal Society, doesn't mind one bit that the computers are used. According to Garrison, the gift "... is an outstanding example of how industry and the non-profit sector can join in programs that put to great service used, but useful, products."

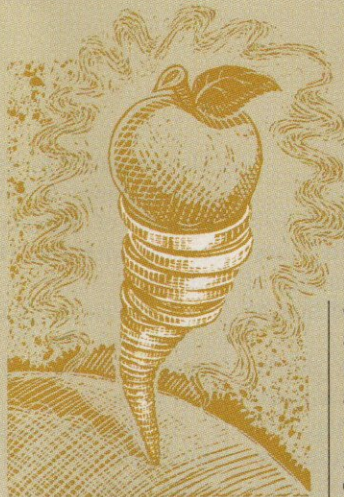

## ▶ APPLE SALES BOOMING

Despite the roller-coaster ride that Apple stock has been taking, Apple products are selling in record quantities. During the first half of Apple's 1985 fiscal year, sales were more than \$1 billion dollars, compared to about \$600 million for the same period last year. In terms of units sold, Apple had about a 35% market share of all microcomputers sold during that period.

Apple president and CEO John Sculley explained the strong sales by saying, "Our business in the education market during the second quarter exceeded our expectations... Apple's revenues increased substantially over the same period a year ago, and at a rate most other industries would consider a major achievement."

## ▶ WHEELS FOR THE MIND

The member institutions of the Apple University Consortium have already acquired more than 50,000

Macintosh computers, and some fascinating projects are now underway. For those of you who are interested in what's happening with the consortium, Boston College is publishing a newsletter called *Wheels for the Mind* as a forum for exchanging information and ideas about collegiate computing with the Macintosh. If you're interested in more details, contact *Wheels for the Mind*, Boston College, Fulton 430, Chestnut Hill, MA 02167.

## ▶ ANIMATION SENSATION

Wow! That's what I said when I first had a chance to play with VideoWorks, the new animation program for the Macintosh that was developed by Marc Canter and the other folks who brought you MusicWorks. VideoWorks is a remarkable program that produces stunning animated graphics for both fun and business. Animation for business? you ask. Believe me, some of the animated business presentations I've seen that use

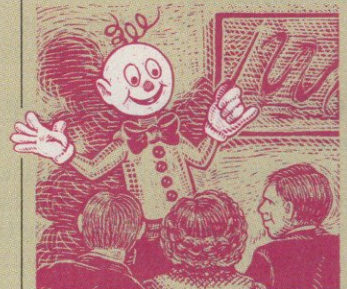

VideoWorks are extraordinary. Look for a feature article on this milestone program in next month's issue of *A+*.

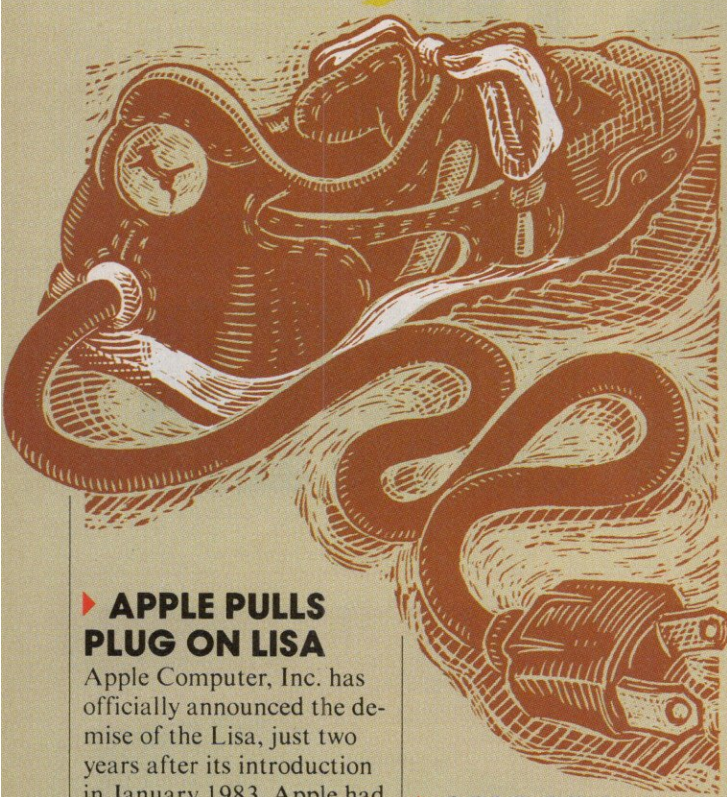

## ▶ APPLE PULLS PLUG ON LISA

Apple Computer, Inc. has officially announced the demise of the Lisa, just two years after its introduction in January 1983. Apple had grand plans for the Lisa and spent more than \$50 million developing the product. Apple originally thought that the Lisa would be the machine that established Apple as a supplier of computers to large corporations, but now the company has pinned its hopes for corporate sales on the Macintosh.

The Lisa never did as well as Apple expected, and the company made a last-ditch attempt at bolstering sales by renaming the computer the Macintosh XL (see "News +," April 1985). Now Apple has decided to consolidate its product line to include just the Apple II and the Macintosh. In a related announcement, Apple said it would introduce a 20-megabyte hard disk for the Macintosh that fits under the computer in order to conserve desk space. The hard disk will allow the Mac to take over the Mac XL's role.

## ▶ SOLE OF A NEW MACHINE

I've heard of the old soft shoe, but shoe software? The Puma RS Computer Shoe and Software Package press release is one of the wildest to cross my desk in some time.

The shoe contains microelectronics that measure how far you run in a session, or series of sessions. When you get back from your run, you simply plug your shoe into your IIe; the accompanying diskette contains software that tells you how far you've run and how many calories you've expended.

The shoe has a built-in stopwatch and sensing devices that detect the number of times your foot hits the ground. The shoe is programmable; you can specify a certain distance, and the shoe emits a beep when you've run that far. Who'd have thought we'd ever have footwear software?

## ▶ PARLEZ-VOUS PC?

In May I told you that Nolan Bushnell was putting chips in computerized pets. Now Puma has put chips in its computerized shoe. To top it off, IBM has put chips into a computerized magazine advertisement that appeared in 270,000 copies of *Le Point*, France's leading newsweekly.

The IBM ad was a four-page advertising insert that contained a microprocessor, a speaker, two batteries, and lights that were all sandwiched inside a page. The first page of the insert told readers, "Open your eyes, you won't believe your ears." When they turned the page, they saw IBM's little tramp next to an electronically lit IBM PC, while a tiny speaker played pre-recorded music. The two batteries allowed the ad to run for about 75 hours.

Dominique Sebilleau, the advertising manager for the IBM PC in France, said that the expensive ad was de-

signed to change IBM's image from that of a big, unwieldy corporate monster. This image may be part of the reason that Apple is out-selling IBM more than 2 to 1 in the French market.

## ▶ APPLE III FOREVER?

The Association of Independent Microdealers (AIM) has announced a new promotion called Apple III Is for Me. AIM plans to act as a central clearinghouse for Apple III owners and microcomputer dealers. AIM hopes that the Apple III Is for Me program will help Apple III users locate products for their computers and that it will help dealers and manufacturers locate potential customers. For further information, contact Ronald A. Wallace, President, Association of Independent Microdealers, 3010 N. Sterling Avenue, Peoria, IL 61604; (309) 685-4843.

## ▶ ENHANCED APPLEWORKS

Rumor has it that Rupert Lissner is hard at work creating a new version of AppleWorks for the Apple II that incorporates features such as the mouse, icons, pull-down menus, and dialog boxes. The new version supposedly will not be ready until the end of this year. These new features will almost certainly make use of MouseText, which means you will need a IIc or an enhanced IIe to use the program. +

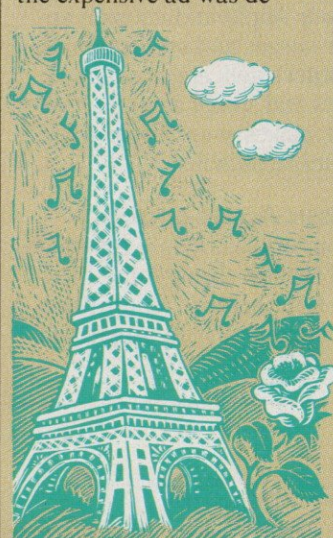

# CLOSE TO 1/4 MILLION APPLE II's SAVED

**SYSTEM SAVER**<sup>®</sup> from Kensington Microware quietly protects close to 1/4 million Apple<sup>®</sup> II's every day. Often referred to as "the piece Apple forgot," System Saver's unique combination of features have made it the most versatile, most convenient, best selling accessory ever made for the Apple.

## **System Saver organizes your power needs.**

To make your Apple system more convenient, System Saver provides extra outlets for your monitor and printer, while replacing the Apple's power cord. One front-mounted power switch controls your whole system.

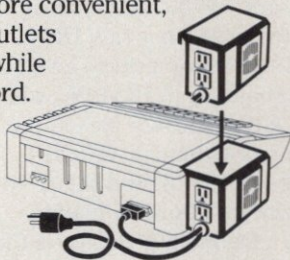

## **System Saver solves power line problems.**

Impurities in the power supply cause 70-90% of all microcomputer malfunctions. Line noise can be interpreted as data, confusing your Apple and causing annoying system errors. Power surges and spikes can do costly damage to your computer's delicate circuitry.

System Saver clips surges and spikes at a safe level and filters out line noise. It makes your Apple more accurate, more efficient and more reliable.

## **System Saver keeps your Apple cool.**

Peripheral cards added to your Apple not only generate heat, they block any natural air flow through the computer. The resulting high temperature conditions can potentially shorten the lives of both your Apple and your peripheral cards.



System Saver's quiet fan draws a breath of fresh air across the Apple's mother board, over the power supply and out the side ventilation slots at the rate of 17 cubic feet per minute.

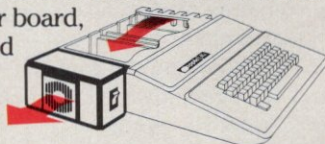

Close to 1/4 million Apple owners think of System Saver as the piece Apple forgot. And 1/4 million well-protected Apples agree. Available at your local dealer. For more information, contact Kensington Microware, 251 Park Avenue South, NY, NY 10010, (212) 475-5200  
Telex: 467383 KML NY.

**K KENSINGTON<sup>®</sup>  
MICROWARE**



## THOUGHTWARE BY STEVE ROSENTHAL

With Microsoft's latest entry for the Macintosh, the business-software competition is heating up.

# WILL EXCEL DO JUST THAT?

Financial and numerical processing are what managers want most out of computers, at least the surveys say so. That's why VisiCalc was the corporate hit on the Apple II and Lotus 1-2-3 on the IBM Personal Computer. And that's why Microsoft is betting that its new entry, Excel, will be a business best-seller on the Macintosh.

Microsoft let *A+* take a look at a prerelease version of Excel, with the warning that some small aspects of design may be changed and performance will definitely be tweaked up by June's scheduled release. This isn't vaporware, though—I've actually had the program running, with all the promised functions operational except some types of data transfers and the help messages.

Excel is a spreadsheet with integrated graphics and a simple database, an almost direct Macintosh analogy of Lotus 1-2-3. Compared to Lotus Jazz for the Macintosh, Excel is simpler, more oriented toward numbers, and several hundred dollars less expensive. More simply, Excel is more like 1-2-3, and Jazz is more like Symphony.

In another sense, Excel is an upgrade to Microsoft's highly regarded Multiplan spreadsheet, combined with the Microsoft Chart graphing program. If you know how to use those programs, in fact, you're most of the way to a working familiarity with Excel. With The Switcher, you can run Multiplan and Chart in tandem, but Excel takes care of shipping the data around automatically and lets you open multiple windows for charts and spreadsheets and move between them.

### Some Specifics

Here are some of the specifics. Excel offers a huge spreadsheet of 256 rows by 16,384 columns, 42 types of business charts, and a row-and-column type of

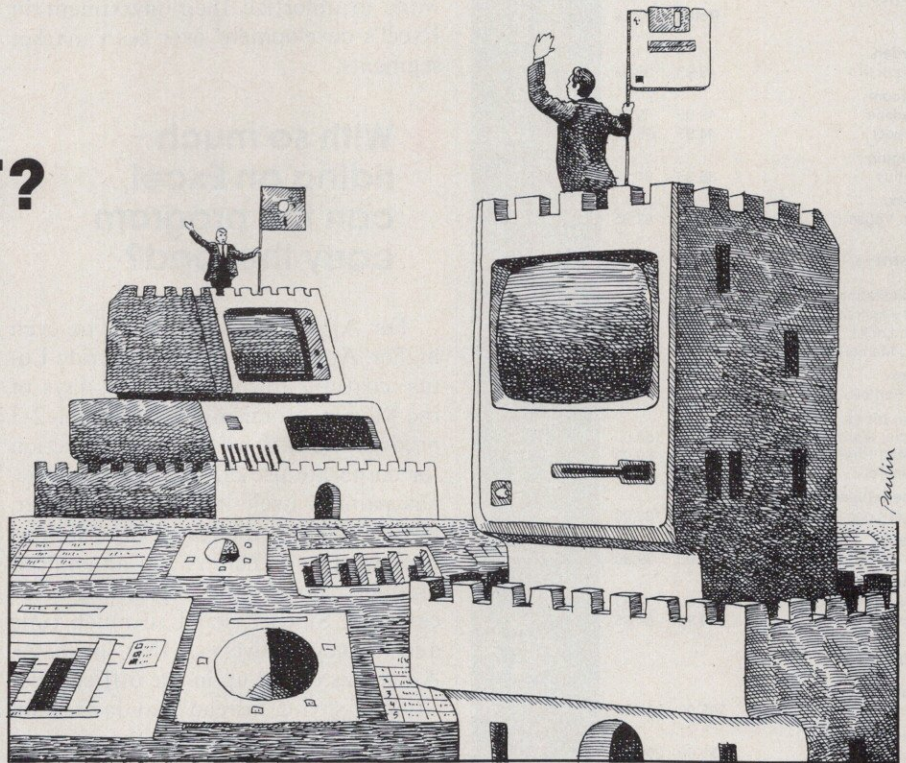

database. Cells in one spreadsheet can refer to parameters or calculated values in another, so you can easily consolidate detailed views into a more global perspective. For automating repetitive tasks, a built-in "macro" function can remember your procedures.

The program follows almost all the

**Microsoft is betting that its new entry, Excel, will be a business best-seller on the Macintosh.**

expected rules of the Macintosh user interface, letting you use the mouse to pick most operations from pull-down menus or by clicking on selections. You can cut, paste, scroll, and select with the mouse and pick your typeface, type-style, and size. Excel has excellent data import/export capabilities. You can ship data back and forth between Excel

and Microsoft's Multiplan or Chart on either the Mac or the IBM PC, or even Lotus 1-2-3 on the PC.

### It's Strategic

Putting aside for a moment the question of whether the program works well, it's obviously an important product for competitive reasons. From Microsoft's view, it's the opening shot in a battle to reclaim a bigger share of the corporate software dollar from upstart firms such as Lotus. Corporate users don't buy a lot of compilers, and they don't spend a lot of money on Flight Simulator (which, even if they buy it, is priced as a game). They're not even buying word-processing programs at rates close to those for spreadsheets.

Excel is targeted right at the most well-trodden path to corporate sales, a path hewn perhaps by VisiCalc but paved, in large part, by Lotus 1-2-3 for the IBM PC. While Lotus is still struggling to win the acceptance for Symphony that it had for 1-2-3 in the IBM arena, Microsoft obviously figures that similar market forces will favor Excel

# THE BEST FOR LESS

## Macintosh

Games	Retail	Your Price
<b>Hayden</b>		
Sargon III	49.95	39.95
<b>Infocom</b>		
Deadline	49.95	39.95
Suspect	44.95	35.95
<b>Penguin</b>		
Xyphus	39.95	31.95
<b>Videx</b>		
Mac Vegas	59.95	47.95

## Business/Utilities

<b>Assimilation Process</b>		
Mac Keystroke Recorder	29.95	23.95
Mac Lockit	29.95	23.95
Mac Memory Disk	29.95	23.95
<b>Axlon</b>		
Art Portfolio	59.95	47.95
<b>Dow Jones</b>		
Market Manager Plus	199.95	160.00
Spread Sheet Link	99.95	80.00
Strait Talk	79.95	64.00
<b>Expertelligence</b>		
Exper Logo	150.00	130.00
<b>Palantir</b>		
Mac Type	49.95	39.95
<b>T-Maker</b>		
Click Art Effects	49.95	39.95
Click On	79.95	64.95

## Hardware

<b>Koala</b>		
MacVision	395.00	319.95
<b>Thunderware</b>		
Thunderscan	250.00	200.00

## Apple

	Retail	Your Price
<b>Central Point Hardware</b>		
Copy II plus 50	39.95	31.95
<b>CBS</b>		
Mastering SAT	150.00	120.00
<b>Data Transform</b>		
Fontrix	95.00	76.00
Font Paks (Vol. I Through 9)	ea. 24.95	ea. 19.95
<b>Howard Soft</b>		
Tax Preparer	250.00	199.95
<b>Hayes</b>		
Joystick Mach III IIe/IIc	59.95	43.95
<b>Krell</b>		
Krell SAT	299.95	240.00
<b>MicroSci</b>		
A2 Disk Drive IIe/II+	300.00	187.50
A5 Drive IIc	350.00	219.95
<b>Spring Board</b>		
News Room	49.95	39.95
<b>SEI</b>		
Spanish, French or German	39.95	34.95

For free catalog write to:

**NONAGON SOFTWARE**

For technical information & Order Status Call (415) 237-5283

800-942-2058  
In Calif. 800-223-8327  
Hours 8 AM-6 PM PDT

P.O. Box 1486  
El Cerrito, CA 94530

In Bay Area Visit  
**SOFTWARE SOLUTIONS**  
11185 San Pablo Ave.  
El Cerrito, CA 94530  
Hours; 10 AM-6 PM

CIRCLE 125 ON READER SERVICE CARD

over Jazz for the Macintosh.

Excel's importance for Microsoft may go beyond the Mac. Although Excel makes heavy use of the Macintosh user interface and the Macintosh QuickDraw routines, Microsoft currently sells both major components of the package—Multiplan and Chart—for the IBM PC and other MS-DOS machines. It is hard to believe that the ace marketers from Bellevue won't want to amortize their investment in Excel's development over both market segments.

**With so much riding on Excel, can the program carry the load?**

For Apple, the stakes may be even higher. Apple, having hoped to ride Lotus' coattails during the early days of the Mac by promising the "Lotus 1-2-3 product" (Jazz) as the key attraction for corporate use of this new machine, has painted itself into quite a corner, first as the announcement date slipped backward and then as the announced product joined the "recedingware" category. Since it spent so much time and money delivering that message, Apple has ended up in the difficult position of saying instead that Jazz is not all that necessary and that there's plenty of other good business software for the Mac.

Having an alternative to Jazz will reassure corporate buyers, partially vindicate Apple, and give the Macintosh community something positive to displace speculation about any problems Jazz may be encountering.

Excel may also prove to be an extremely strategic product for Apple's new "peaceful coexistence with IBM" approach to the corporate office. One of the points Microsoft's competitive summaries for Excel emphasizes is that this product not only reads but also writes data in the form Lotus 1-2-3 uses (Jazz, at last announcement, only reads 1-2-3 data). If they have access to a network linking IBM PCs and Macs, Excel users will be able to exchange data freely with 1-2-3 users in both directions. As any student of politics will tell you, one-way trade makes for tension and dispute, and two-way balanced trade promotes peace and harmony.

**Can It Carry the Load?**

With so much apparently riding on Excel for both Apple and Microsoft,

# INCREASE YOUR DISK CAPACITY 100%

**DOUBLES DISKETTES INSTANTLY!**

Now, the back of 5 1/4" diskettes can be used, even in a single-head disk drive. Double all your present diskettes safely... without disturbing the existing data!



U.S. PAT. 4,488,358

cuts square notch for Apple, Franklin, and Commodore

**only \$14.95\***

**ALSO**

## DISK OPTIMIZER SYSTEM<sup>®</sup>

SOFTWARE FOR APPLE II, II+, IIe, III, AND FRANKLIN  
**CERTIFIES YOUR NEW DISK 100% ERROR-FREE!**  
• Locks out bad sectors • Adds 36th track • Performs disk drive speed check • Adds DOS • And More!

### SPECIAL PACKAGE PRICE

Nibble Notch 1 & Disk Optimizer Combo (Optimizer alone reg. \$24.95)\* **\$29.95\* FOR BOTH!**

**INQUIRE ABOUT OUR ALL-NEW MULTILINGUAL DISK OPTIMIZER!**

\* On all orders add \$2 for postage & handling (\$5 Foreign). Florida res. add 5% Sales Tax.

**SATISFACTION GUARANTEED OR YOUR MONEY BACK!**



**ORDER TODAY**



**TOLL FREE 1-800-642-2536**  
FLORIDA 305-493-8355

or send check or money order to:  
**nibble notch<sup>®</sup>**  
computer products

4211 NW 75th Terrace • Dept. 2 31  
Lauderhill, FL 33319

CIRCLE 263 ON READER SERVICE CARD



*You oughtta be in pictures* **the contest**

- Create
- Animate
- Produce Your Own Computer Movies

**Enter Take 1's  
"You Oughtta Be In Pictures - The Contest"  
And Win A \$1,000 Shopping Spree**

**TAKE 1** is Hollywood Magic on a floppy disk and you are in the director's chair. Imagine writing, producing, and directing your own computer movies. Whether magical illusions, special effects... cartoons, school reports, or business briefings, only you can decide for the script is yet to be written. **TAKE 1** gives you the power of animation. Your creativity brings it to life.

**HOW US YOUR BEST AND WIN**

Now the creators of **TAKE 1** present "You Oughtta Be In Pictures — The Contest" to give you a chance to show off your creativity and win valuable prizes. Send us your best movie, created with **TAKE 1** on your Apple computer. You will be eligible to win and choose from hundreds of computer products for your home or school.

To judge your work, we've assembled a high-powered panel of Judges. They'll choose the Best of the Best and

winners will be announced in January, 1986 at the Consumer Electronics Show in Las Vegas.

**PANEL OF JUDGES**

- Steve "Woz" Wozniak; Co-Founder, Apple Computer
- Bob Singer; Art Director, Hanna Barbara Productions
- Vibeke Sorensen; Educator/Animator, California Institute of Technology, California Institute of the Arts
- Maggie Canon; Editor, A + Magazine

**SEND NOW FOR DETAILS**

To get started, send now for entry rules and forms. You can also order the **TAKE 1** Tips Disk and our full-color "You Oughtta Be In Pictures" poster (shown above).

**SEE YOUR DEALER** for dealer location or direct orders call **ORDER LINE: 1-800-824-8873** (In Mich: 1-616-957-3036)

CIRCLE 156 ON READER SERVICE CARD



**Send to:** Baudville, 1001 Medical Park Dr., S.E., Grand Rapids, Michigan 49506

\_\_\_ Please send me the Official "You Oughtta Be In Pictures Contest" Entry Form and Rules. (No entry fee required.)

\_\_\_ I want the **TAKE 1** Movie Tips Disk and full-color poster. (Enclosed is \$6.50 for shipping and handling.)

NAME \_\_\_\_\_

ADDRESS \_\_\_\_\_

CITY, STATE, ZIP \_\_\_\_\_

For Apple II, Apple II + Apple IIe, Apple IIc or compatible computers with 64K.

Apple is a registered trademark of Apple Computer, Inc.

## Add a *smart* Print Screen Key to your Apple.

The FingerPrint+™ Serial and Parallel Printer Interface card lets you print whatever you have on the screen, just by the push of a button, without interrupting your program.

- Compatible with most popular parallel and serial printers.
- Connect 2 printers to the same FingerPrint+™
- Jump from one printer to the other with a single keystroke command, without interrupting your program.
- Fully software compatible, including Apple Works and Apple Mouse.
- Over 30 command functions available at the touch of a button.
- Graphics/Text dump, Hi and Lo-Res graphics, rotated 90 degrees and double size graphics.

FOR MORE INFORMATION AND THE DEALER NEAREST YOU CONTACT:

**(305) 592-7522**

**THIRDWARE**  
COMPUTER PRODUCTS™  
4747 NW 72nd Avenue, Miami, FL 33166



Apple, Fingerprint+ and Thirdware Computer Products are registered trademarks, respectively, of Apple Computer, Inc. and Precision Software.

CIRCLE 106 ON READER SERVICE CARD

can the program carry the load? Is it what corporate users will want and buy?

As a spreadsheet, Excel should get the same high marks Multiplan has garnered. You have to be a certain kind of person to be a spreadsheet fan, and if you're that type, you'll probably like Excel. Even if you're a more casual user, you'll probably find that if you need one of the more powerful spreadsheet programs, this one has a good power-to-complexity ratio.

As with any spreadsheet software, Excel provides you with a row-and-column display, with each box made by the intersecting lines considered a cell. You can put data, formulas, or text in any cell, including formulas that depend in part on the value of other cells. That ability allows you to prepare budgets, projections, taxes, income statements, expense analyses, and so on.

The Excel spreadsheet is memory-resident, so setting up your columns, formatting entries, and entering data are all quick and easy. You can make cell entries directly by clicking on a cell to make it the active cell and then entering text in the formula bar at the top of the screen. In addition, you can take advantage of the mouse to select other cells, predefined functions, names you have given to regions, or any other information Excel has stored up. You can even read cells from spreadsheets created by your coworkers on a network.

The Default mode is to treat all cell references as relative to the active cell, but you can also select the Absolute mode when you want it. You can give cells, regions, or even collections of disparate regions a name, by which you can refer to them in formulas or in charts. To refer to a cell in another spreadsheet, you cite the spreadsheet name, combined with the cell, range name, or position. If the necessary spreadsheet isn't on the current data disk, Excel prompts you to change disks until it finds the requested data.

Excel also lets you open up multiple windows, with a spreadsheet in each one (and you can keep a spreadsheet open and on the desktop but hidden away behind other windows). This option allows you to work with multiple spreadsheets, look at distant parts of the same spreadsheet, or see the effects on one region of the spreadsheet as you change values in another. When you recalculate, any change that affects an open spreadsheet causes recalculation of dependent values, even if the values are in a hidden window.

# Shhhhhh!



**The quietest Apple®-compatible disk drive is nearly half the cost of Apple®. It's Gamma.**



Video Technology (U.S.) Inc.  
2633 Greenleaf  
Elk Grove Village, IL 60007  
(312) 640-1776

Gamma makes color-matched drives for Apple® IIc, IIe, and II+: fully compatible and quieter than Apple® accessory drives at roughly half the cost. PVC chassis absorbs sound. 6-month warranty.

CIRCLE 180 ON READER SERVICE CARD  
APPLE IS A REGISTERED TRADEMARK OF APPLE COMPUTER INC.

# MODEM AUTO-DIAL/AUTO-ANSWER \$69.95

## EPROM PROGRAMMER FOR APPLE COMPUTERS

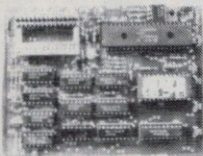

RP525  
\$79.95

- \* DUPLICATE OR BURN ANY STANDARD 27xx SERIES EPROM
- \* EASY TO USE MENU-DRIVEN SOFTWARE INCLUDED
- \* MENU SELECTION FOR 2716, 2732, 2732A, 2764 & 27128
- \* HIGH SPEED WRITE ALGORITHM
- \* LED INDICATORS FOR ACTIVITY
- \* NO EXTERNAL POWER SUPPLY REQUIRED

## DISK DRIVES

FOR APPLE COMPUTERS

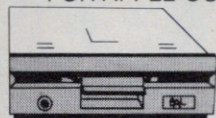

BAL-525  
\$139.95

- \* 1/2 HEIGHT-ALPS MECHANISM
- \* 100% APPLE COMPATIBLE
- \* FULL 1 YEAR WARRANTY

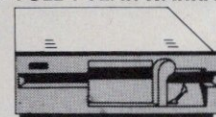

BAL-500  
\$159.95

- \* TEAC MECHANISM- DIRECT DRIVE
- \* 100% APPLE COMPATIBLE
- \* FULL 1 YEAR WARRANTY

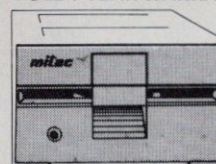

MITAC  
AD-1  
\$149.95

- \* FULL HT. SHUGART MECHANISM
- \* DIRECT REPLACEMENT FOR APPLE DISK II
- \* SIX MONTH WARRANTY

### DISK DRIVE ACCESSORIES

DISK CONTROLLER CARD \$49.95  
APPLE IIc ADAPTOR CABLE \$19.95

## NEW FOR APPLE IIc

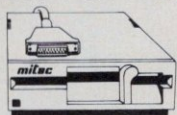

MITAC  
AD-3C  
\$139.95

- \* 100% APPLE IIc COMPATIBLE, READY TO PLUG IN W/ SHIELDED CABLE & MOLDED 19 PIN CONNECTOR
- \* FAST, RELIABLE SLIMLINE DIRECT DRIVE
- \* SIX MONTH WARRANTY

## TAXAN RGB VISION III

SUPER HI-RES RGB MONITOR

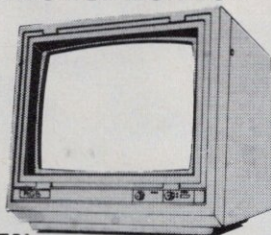

ORIGINALLY  
MADE  
FOR  
ACORN  
COMPUTER

- \* 12" SCREEN
- \* 640 x 262 PIXELS
- \* 18 MHz BANDWIDTH
- \* 25 LINES x 80 COLUMN
- \* .38mm DOT PITCH WITH BLACK MATRIX FOR A SHARP IMAGE AND HIGH CONTRAST

ONLY \$299.95

NO C.O.D. ORDERS PLEASE!

ORDER TOLL FREE

800-538-5000

800-662-6279

(CA RESIDENTS)

## BMC MONITOR STAND

MODEL PA-900

TILTS AND SWIVELS  
TO PROVIDE  
OPTIMUM VIEWING  
ANGLE, REDUCES  
OPERATOR FATIGUE



FACTORY SPECIAL \$14.95

16K RAM CARD \$39.95

- BARE PC CARD AND INSTRUCTIONS \$9.95
- \* 2 YEAR WARRANTY
- \* EXPAND YOUR 48K APPLE TO 64K
- \* USE IN PLACE OF APPLE LANGUAGE CARD

## APPLE ACCESSORIES

VIEWMAX-80 \$159.95  
VIEWMAX-80e \$129.95  
GRAPHMAX \$129.95  
THUNDERCLOCK \$129.95  
KRAFT JOYSTICK \$39.95  
POWER SUPPLY \$49.95

## MODEM FOR APPLE OR IBM FCC APPROVED

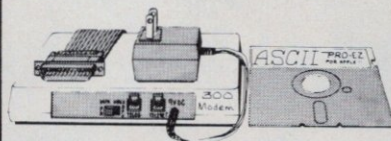

INCLUDES  
ASCII PRO-EZ™  
MENU DRIVEN SOFTWARE  
(A \$100 VALUE IN ITSELF!)

ONLY \$69.95

- \* BELL SYSTEM 103 COMPATIBLE
- \* 300 BAUD
- \* AUTO-DIAL/AUTO-ANSWER
- \* DIRECT CONNECT
- \* INCLUDES AC ADAPTOR

PLEASE SPECIFY APPLE OR IBM WHEN ORDERING

## VERBATIM DATALIFE DISKETTES

SS/DD SOFT SECTOR \$29.95  
SS/DD 10 SECTOR HARD \$29.95  
DS/DD SOFT SECTOR \$34.95

## NASHUA DISKETTES

5 1/4" SOFT SECTOR  
DS/DD WITH HUB RINGS  
\$1.39ea. \$1.49ea. \$1.59ea.  
QTY 250 QTY 100 QTY 50  
THESE DISKETTES ARE BULK PACKAGED

## DISKETTE FILE

\$8.95 IF PURCHASED  
WITH 50 DISKETTES  
OR MORE

\$9.95 IF PURCHASED ALONE

HOLDS 70 5 1/4"  
DISKETTES,  
WITH ROOM  
TO SPARE



RETAIL STORE - 1256 S. BASCOM AVENUE  
HOURS: M-W-F, 9-5 TU-TH, 9-9 SAT, 10-3

PLEASE USE YOUR CUSTOMER NUMBER WHEN ORDERING

TERMS: Minimum order \$10.00. For shipping and handling include \$2.50 for UPS Ground and \$3.50 for UPS Air. Orders over 1 lb. and foreign orders may require additional shipping charges - please contact our sales department for the amount. CA. residents must include 6% sales tax. Bay Area and LA residents include 6 1/2%. All merchandise is warranted for 90 days unless otherwise stated. Prices are subject to change without notice. We are not responsible for typographical errors. We reserve the right to limit quantities and to substitute manufacturer. All merchandise subject to prior sale.

Apple is a trademark of Apple Computer Co.

# JDR Microdevices

1224 S. Bascom Avenue, San Jose, CA 95128

800-538-5000 • 800-662-6279 (CA) • (408) 995-5430

FAX (408) 275-8415 • Telex 171-110

© Copyright 1985 JDR Microdevices

# How to make the world's greatest impression. Just \$399.



Write! A person can move nations with a well presented idea.

The word processor is mightier than the sword, but only as sharp as its printer.

Daisy wheel printers produce strong, rich impressions. Impressions a dot matrix printer cannot make.

And now price is no longer an obstacle to the Write Impression. The Alphapro 101 prints letter quality for \$399.

The Alphapro 101 is a 20 character

per second, letter quality, daisy wheel printer—No other high performance letter quality printer can match our price. Compare the Alphapro 101 and see. Its solid craftsmanship and one-year warranty make it the most reliable buy in its price range. And it's compatible with all popular microcomputers: IBM® PC, PCjr., XT, AT;™ Apple® IIe, IIc, and Macintosh.™

The Alphapro 101 will make your point more powerful by showcasing your ideas in clean,

crisp, to-the-point type.

So don't wait. See your local Alfacom dealer and make the Write Impression on the world *today*.

For the Alfacom dealer in your area, call Alfacom direct, **408-559-8000**.

2323 South Bascom Avenue, Campbell, CA 95008

**Alfacom**  
THE WRITE IMPRESSION.

CIRCLE 328 ON READER SERVICE CARD

Because I was looking only at a pre-release version, I couldn't determine how quickly the spreadsheet in the final version would do calculations. Excel uses a selective recalculation technique that keeps track of which cells are affected when you make any change or addition, however. During recalculation, only affected cells are recomputed, a procedure that speeds processing considerably.

### Spares Not Memory

Unfortunately, Excel doesn't seem to manage memory use with the finesse with which it handles calculations. As has been common until recently in spreadsheets, Excel allocates memory to account for the largest rectangle of cells that includes row 1 column 1 and the entry you make the furthest down and to the right. Thus, if you enter values in just one cell in row 100, column 100, Excel saves space for 10,000 cells.

So, although the potential spreadsheet size of  $256 \times 16,384$  cells sounds impressive, you can't really use that much of it. The biggest square you can get on a 512K Mac, in fact, ends at about row 245, column 245. Excel claims disk storage with a similar voracity.

The two-sided coin of ease of use and high speed, on the one hand, and limited capacity, on the other, marks Excel's database function as well as its spreadsheet. The database is similar to the capabilities of Multiplan, not the more extensive record-keeping facilities of Microsoft's File. You can declare any rectangular area of the spreadsheet a database, with each row treated as a record and each column as a field. Data in the fields can be the same numeric, logical, or textual values that are permissible in ordinary Excel spreadsheet cells. You can sort or select database regions (up to three fields used as the key per sort) on any combination of fields. Excel has a complement of functions that work on databases, and you can employ their results or database values in spreadsheet formulas.

In practice, you ought to think of Excel as having a sorting and selection capability for spreadsheet regions, rather than a true database component. It's quick and easy, but it doesn't have any kind of reporting or text-formatting ability. My guess is that the database function will be the least-used of Excel's major features.

In contrast, the graphing section of Excel looks to be a hit. The most difficult part of drawing a chart is figuring out how to get it started (you select the

# "We will match any mail order price in this issue."

We'll support, service and warranty everything we sell and stand behind it 100%. We won't charge you for shipping or handling, nor will we penalize you for using a credit card.

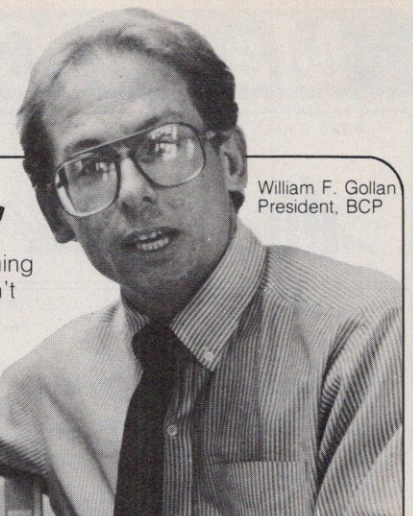

William F. Gollan  
President, BCP

COMPUTERS		SOFTWARE FOR Ile, Iic	
Apple files & lics	CALL	Champ Lode Runner	24.95
<b>MODEMS</b>		Classmate	34.95
Hayes Smart 300 Iic	119.95	Chopflifer	24.95
Hayes Smart 1200	389.95	Computer SAT	54.95
Hayes Micro Ilic w/svc	169.95	Conan	27.95
		Cuthroats	27.95
		Dallas Quest	24.95
		Dazzle Draw	<b>35.95</b>
		Deadline	34.95
		Delta Draw	34.95
		Dig Dug	19.95
		Dragon World	27.95
		Epyx Baseball	Call
		Exp. Amazon	24.95
		Exodus Ultima III	45.95
		F-15 Strike	24.95
		Facemaker	24.95
		Fahrenheit 451	27.95
		Felony	24.95
		Flight Simulator II	34.95
		GATO	27.95
		Gertrudes Secret	29.95
		Gertrude's Puz.	29.95
		Ghostbusters	27.95
		Golf's Best	<b>35.95</b>
		Gorens Bridge	54.95
		Graphics Dept.	74.95
		Graphics Magician	34.95
		Hitchhikers Guide	27.95
		Kids on Keys	19.95
		Kindercomp	19.95
		Kings Quest	34.95
		Koala M Keys	49.95
		Lode Runner	24.95
		M Lge. Baseball	<b>27.95</b>
		Magic Paintbrush	24.95
		Master Type	27.95
		Math Blaster	34.95
		Mastering SAT	99.95
		Micro	
		Cookbook	27.95
		Deserts	9.95
		Soups	9.95
		Appelizers	9.95
		Millionaire	34.95
		Mind Prober	34.95
		Minit Man	34.95
		Moptown Parade	27.95
		Muppet Learning	49.95
		Murder by Dozen	24.95
		NATO Comm.	24.95
		Night Pinball	24.95
		Paper Graphics 1.2 (ea)	24.95
		Pensate	24.95
		Pattern Maker	27.95
		Personal Net W.	54.95
		Planetfall	27.95
		Pole Position	20.95
		President's Choice	29.95
		Print Shop	34.95
		Print Shop GL	19.95
		Print Shop RE	10.95
		Robot Odyssey	34.95
		Rocky's Boot	34.95
		Rogue	20.95
		Run for \$	27.95
		Sargon III	34.95
		Seastalker	24.95
		Serpent's Star	27.95
		Sideways	39.95
		Simon Sch. T. Tutor 3	34.95
		Solo Flight	24.95
		Songwriter	27.95
		Sorcerer	29.95
		Speed Reader II	44.95
		Spellcopier	24.95
		Squire	34.95
		SSI	
		Baseball	27.95
		Beststone W.	27.95
		Golf	27.95
		War Russia	49.95
		Reforged 88	39.95
		Tigers in Snow	27.95
		Objective Kursh	27.95
		Mission Crush	27.95
		Germans 85	39.95
		Battle Norm.	27.95
		Baltic 85	24.95
		Phantasia	27.95
		Story Machine	24.95
		Stellar 7	19.95
		Sticky Bear	
		ABC	27.95
		Math	27.95
		Reading	27.95
		Pic Builder	27.95
		Spellgrabber	27.95
		Typing	27.95
		Run for It	27.95
		Success w/Math (ea)	18.95
		Supersport	20.95
		Suspect	29.95
		Sword Kadash	24.95
		Terrain Logo	64.95
		The Quest	<b>24.95</b>
		Transylvania	24.95
		Trivia Fever	27.95
		Tycoon	34.95
		Welcome Aboard	27.95
		Where in World	<b>27.95</b>
		Word Attack	34.95
		Wizardry 1	34.95
		Wizardry 2	24.95
		Wizardry 3	27.95
		Xyphus	24.95
		Zaxxon	24.95
		Zork 1,2,3(ea)	29.95
		<b>Books</b>	
		Apple Grap/Arc.	18.95
		Bag of Tricks	29.95
		Beneath Apple DOS	18.95
		Understanding the Apple	19.95
		Invislues	9.95
		Master PFS:	14.95
		6502 Assembly	19.95
		<b>MACINTOSH SECTION</b>	
		<b>Apple</b>	
		Mac 128k & 512k	Call
		Mac Drive	429.95
		Mac # Pad	89.95
		<b>Disks</b>	
		Memorex (10)	39.95
		Maxell (10)	39.95
		BASF (5)	19.95
		Sony	<b>39.95</b>
		Flip & File 40	25.95
		<b>Microsoft</b>	
		Basic 2.0	<b>89.95</b>
		Business Pack	<b>349.95</b>
		Chart	<b>79.95</b>
		Enhancer	<b>169.95</b>
		File	<b>119.95</b>
		Logo	<b>79.95</b>
		Multiplan	<b>119.95</b>
		Word	<b>119.95</b>
		<b>Word Processing</b>	
		Bag	20.95
		Catalyst	<b>94.95</b>
		Computer Diet	<b>54.95</b>
		DB Master V 4.0 +	<b>179.95</b>
		Dollars & Cents	64.95
		Dollars & Cents Iic	74.95
		DJ Market Anal.	209.95
		DJ Investors Wk. + Iic	94.95
		DJ Spreadsheet Lnk. +	149.95
		DJ Microscope +	209.95
		Figures & Forms	<b>22.95</b>
		Flashcalc	<b>64.95</b>
		Forcast	39.95
		General Mng.	139.95
		Home Accountant	49.95
		Mng. Your \$	124.95
		Multiplan	<b>69.95</b>
		Net Worth	54.95
		PFS:Best Sellers	<b>169.95</b>
		PFS:File	74.95
		PFS:Report	74.95
		PFS:Graph	74.95
		Supercalc III	<b>129.95</b>
		Turbo Pascal 3.0	<b>47.95</b>
		Turbo Tool	39.95
		Turbo Tutorial	24.95
		<b>Home * Educational *</b>	
		<b>Entertainment</b>	
		Air Rescue	<b>24.95</b>
		Alphabet Zoo	19.95
		Amazon	27.95
		Aerobics	29.95
		Apple Logo	89.95
		Arcade B Camp	19.95
		Aztec	29.95
		Barron	34.95
		Beyond Castle Wolf	24.95
		Brae Lee	27.95
		Cat Graphics	24.95
		<b>Business &amp; Personal</b>	
		Appleworks	199.95
		Arrays GL, AR, AP (ea)	154.95
		ASCII Exp. Pro.	84.95
		<b>Baudville</b>	
		Actors & Action	<b>20.95</b>
		Business	<b>34.95</b>
		Heroes & Vill.	<b>20.95</b>
		Pixit	<b>34.95</b>
		Take-1	<b>37.95</b>
		<b>Beagle</b>	
		Dbl. Take	25.95
		Flex Text	20.95
		Frame Up	20.95
		Pronto DOS	20.95
		Silicon Sal.	17.95
		Utility City	17.95
		D-Code	<b>27.95</b>
		Disk Quick	19.95
		DOS Boss	17.95
		Basic	25.95
		Mechanic	<b>19.95</b>
		GPLE	<b>30.95</b>
		Graphics	<b>37.95</b>
		I/O Silver	<b>20.95</b>
		Triple Dump	27.95
		Fat Cat	25.95
		<b>AST Multi I/O</b>	<b>159.95</b>
		Koala Graphics Pad	79.95
		Microsoft	
		Z80 Soft 2 w/64k	<b>274.95</b>
		Premium Pack Iie	<b>264.95</b>
		Premium Iie w/d/base	<b>334.95</b>
		Quadram	<b>Call</b>
		Titan	
		Accelerator II/Iie	<b>234.95</b>
		64k Ram	<b>149.95</b>
		128k Ram	<b>169.95</b>
		Neptune 64k + 80	<b>189.95</b>
		Neptune 128k + 80	<b>209.95</b>
		Neptune 192k + 80	<b>229.95</b>
		<b>GRAPHIC INTERFACES &amp; BUFFERS</b>	
		Fingerprint +	<b>99.95</b>
		Grappler +	<b>84.95</b>
		Grappler + RS232	<b>84.95</b>
		Grappler w/16k	154.95
		Grappler w/64k	174.95
		Quadram 64k Fazer p/p	159.95
		<b>PRINTERS DOT MATRIX</b>	
		Apple Imagewriter	499.95
		Apple Scribe	249.95
		Citizen MSP 10 160	<b>309.95</b>
		Citizen MSP 15 160	<b>459.95</b>
		Citizen MSP 20 200	<b>459.95</b>
		Citizen MSP 25 200	<b>569.95</b>
		Epson LQ 1500	899.95
		Epson LX 80	239.95
		Epson LX 80 FT	279.95
		Epson FX 80	359.95
		Epson FX 100 +	499.95
		Gemini SG 10	239.95
		Gemini Delta SD 10	369.95
		Gemini Radix SR 10	509.95
		Okidata 192	379.95
		Okidata 192 Image.	399.95
		Okidata 193	519.95
		Okidata 84	664.95
		Toshiba P1340	589.95
		Toshiba P351	<b>1199.95</b>



**BUSINESS COMPUTERS**  
OF PETERBOROUGH  
Gollan Co., Inc.

**FREE SHIPPING**  
CONTINENTAL  
USA/UPS ONLY



**AP0/FPO WELCOME**

766 RT. 101 W. • P.O. Box 772 • Peterborough, NH 03458

ORDERS ONLY: **800-845-3003**

QUESTIONS: 603-924-9406

# MasterChart!

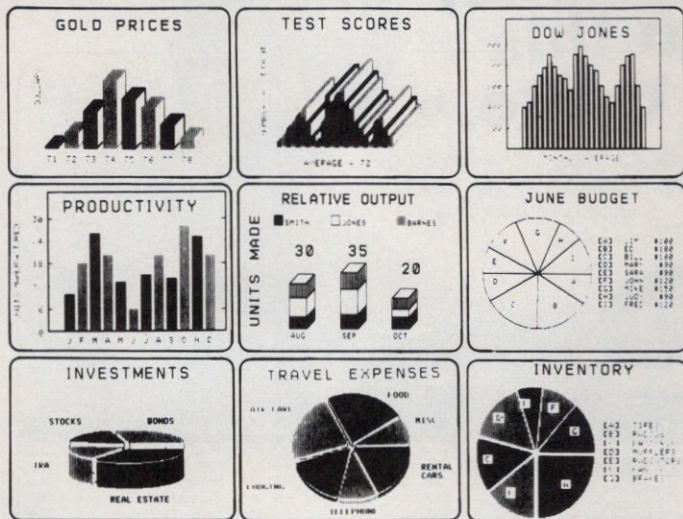

Don't pay more for less! The pictures shown above are examples of charts created with MasterChart!, perhaps the most powerful and friendly Apple II chart program on the market. Within seconds, keyboard-entered data can be converted into picture-perfect pie or bar charts, in 26 user-selectable styles, automatically scaled and labelled, and in color or black and white. And if you want to customize your charts by adding extra artwork or text, or display them in a slide show, MasterChart! comes with these valuable extras....

**A slide projector**, for orchestrating automated, stand-alone screen presentations of a series of charts, timed and sequenced by the user. This program alone is worth the cost of the disk. It can be used with any graphics files created with any program.

**A graphics editor**, for alteration and embellishment of charts. Besides standard point-by-point sketching, built-in structures permit push-button creation of circles, rectangles, lines, shape-table shapes, and exotic woven plaid patterns. If you wish to add clarifying text to the charts, you may type on the screen in several different letter font styles. For the artist, the graphics editor can also be used to sketch any imaginable scene from scratch.

**A shape table editor**, for creating special shapes for your charts. These shapes can also be used for animation in your programs! A sample animation program shows how to do it.

MasterChart! includes a screen-dump program for printing your charts on paper. MasterChart! is more! Just read what these people have to say about it...

*"I noticed the advertisements for Spectral Graphics' Master Chart! program and figured that, with a money-back guarantee, I would try it. Boy, am I glad I did! This is a fantastic program. You can master its many varied capabilities in less time that it would take to describe them. I would recommend it to everyone, even if you have absolutely no need for a graphing program. It's just fun to play with."* S.A. Smith, San Bernadino, Calif... letter to SOFTALK, June, 1984, page 14.

*"The software does much more than the advertisement suggests. Without question, this is among the best buys in software that I have ever come across, and certainly among the best written. It is extraordinarily easy to use, very well thought out, and priced to kill your competition (which I wish you every success in doing)."* Anthony J. Scriffignano, North Caldwell, New Jersey.

*"I have long been distressed by the lack of software available in the scientific/academic community. At last there is a simple yet robust graphics program applicable for our purposes: MasterChart!, by Spectral Graphics Software. Business folks and scientists alike will really appreciate how user-friendly it is; I was able to produce my first three-dimensional, multi-colored, labeled bar graph within five minutes of booting the disk—without reading my documentation. I would have had to pay a scientific illustrator much more than the whole program costs just to produce that one graph... you can't do without this gem."* John B. Iverson, Richmond, Indiana... letter to SOFTALK, April, 1984, page 23.

ONLY \$29.95 Apple II+//IIc. Satisfaction guarantee or your money back (really!). Send a check or purchase order to **SPECTRAL GRAPHICS SOFTWARE**, 6333 Pacific Avenue, Suite 256, Stockton, California 95207. Or call (209) 463-7309 for COD orders and dealer inquiries. MasterChart! is not yet sold in most stores. All orders are shipped immediately and are in your hands within three days.

CIRCLE 109 ON READER SERVICE CARD

range you want graphed, pull down the File menu, select New, click on Chart, and see the result). Once you get a chart on the screen, you can change its type, add or take out legends, add text, or superimpose arrows. You have a choice of seven main types of charts, with six standard variations each, so you should find the type you're looking for. If you've kept your spreadsheet window open, you can make changes in your data and immediately see the result in the graph region.

As slick and easy as the graphics are in Excel, I would have liked to see support for color plotters. Even if Apple wants to convince us that color is unnecessary on the Mac, just see whether the audience at your next meeting or talk

**▶ Excel has a powerful spreadsheet, a well-integrated and easy charting package, and a limited database. If you work only with numbers and need more than Multiplan, give it a workout.**

finds monochrome illustrations very inviting. Perhaps pressure from a firm such as Microsoft could move Apple away from its ideological fixation on this issue.

So there you have it. Excel has a powerful spreadsheet, a well-integrated and easy charting package, and a limited database. If you work only with numbers and need more than Multiplan, you ought to give it a workout—especially if you're a decision maker who wants a quick way to examine, modify, and test figures you get from subordinates and coworkers. Excel's ability to read Lotus 1-2-3 files (which you may have to transfer by phone line until intermachine local-area networks arrive) gives you access to data on IBM PCs but keeps the easy-to-use Macintosh visual interface.

On the other hand, if the prerelease version is a good indication, you may need a hard-disk Macintosh for optimum use of the program. When I tested it, Excel required more than 300K of storage on two disks, which it spent a good deal of time accessing. User-provided data is supposed to be kept in memory, so it looks like the program, even on a 512K Mac without memory partitioned off by The Switcher, uses many overlays—bad news for the less patient among us floppy-disk users. Perhaps it's another reminder that serious business applications for any computer increasingly demand a fast hard disk. If you don't already have such a beast, check out Excel's waiting time to see if you find it acceptable; if not, be sure to add in the cost of a hard disk when you figure out the cost vs. the benefits.

Last, one of the major premises and promises of the Mac is that "knowledge workers" no longer need turn their word work over to secretaries. For writing support, Microsoft recommends you combine Excel and Microsoft Word, using The Switcher. Unfortunately, calculating whether this combination approach or a completely integrated package is better for you is beyond the present ability of Excel or any other spreadsheet. +

*Steve Rosenthal started off writing accounting programs for a large financial house. By most accounts, he now spends a good deal of time writing for A+ from his largely financed house.*



# Rolodex® Software

Desktop management systems from the company that started it all.

Trademark  
Software

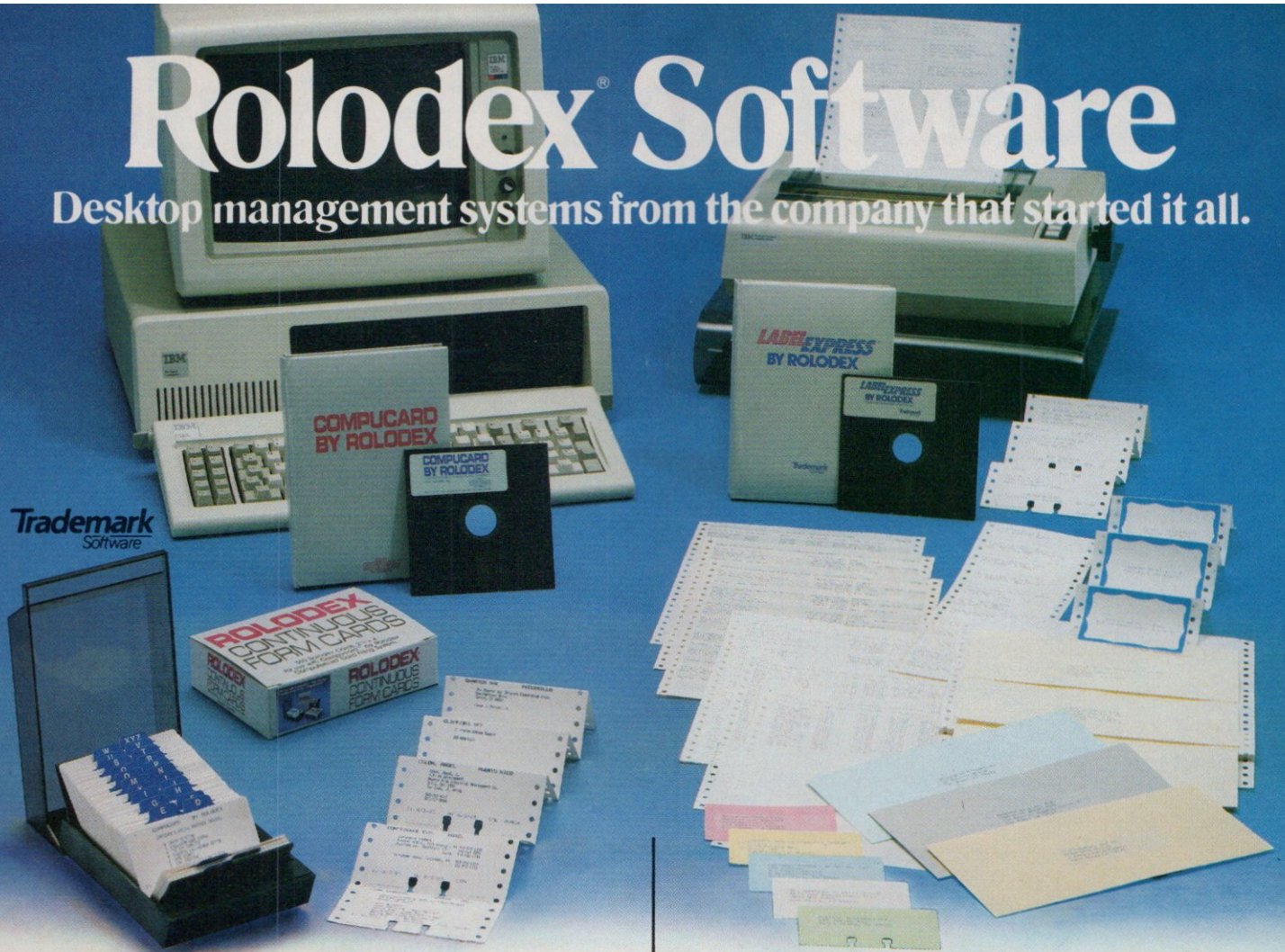

## COMPUCARD BY ROLODEX™

COMPUTERIZED CARD FILING SYSTEM

With Compucard by Rolodex, card sets can be created, updated, edited and duplicated fast and easy to improve office productivity and organization as card filing is simplified.

Compucard Software Program and Documentation Manual are available for IBM®/PC (CSM-I) or Apple® IIe (CSM-A) at \$49.95. They are also available complete with VIP24C Special file and 500 Rolodex Brand Continuous Form Cards, 2¼ x 4" at \$68.50 (CC500-I for IBM and CC500-A for Apple). Compucard features include:  Free-form card format with up to 450 characters per 2¼ x 4" card  Rapid printing  Full-screen editing commands  Date stamping for each entry  Dual indexing  Flexible select code system.

## LABEL EXPRESS BY ROLODEX™

Label and List Management Software

Label Express makes it easy to create labels, locate and update mailing lists, address envelopes, print name badges or Rolodex Brand Continuous Form Cards. Label Express by Rolodex. It keeps you in touch with people.

Label Express software is available for IBM/PC (LSM-I) and Apple IIe (LSM-A) computers, at \$49.95 each. Its powerful features include:  **Creating your own label formats, up to 180 characters on five lines.**  Full-screen editing with popular, word processing commands  Immediate indexing for each new entry  Extensive and time-saving search features  Full combine/merge capability  Customized printing up to 999 copies.

## ROLODEX CORPORATION

245 Secaucus Road, Secaucus, N.J. 07094

An **Insico** Company

CIRCLE 182 ON READER SERVICE CARD

IBM/PC is a registered trademark of International Business Machines Corporation; Apple IIe is a registered trademark of Apple Computer, Inc.

# Quadram Enhances Apples!

Quadram expands the power of the Apple II series personal computers. Quadram set the standard with the Quadboard. Now we offer you Multicore, the card that delivers RAM expansion to 256K, parallel and serial ports, a ProDOS clock/calendar, and RAM drive software. Plus, there's the new Extended Multifunction Card, Clock/Calendar Card, Serial Interface Adapter, and Buffered Serial Interface Adapter. All designed to bring out the best your Apple has to offer. For further details on these cards as well as our popular APIC parallel interface and eRAM 80 cards visit the dealer nearest you, or contact us at 4355 International Blvd., Norcross, Georgia 30093 (404) 923-6666.

## Multicore by Quadram

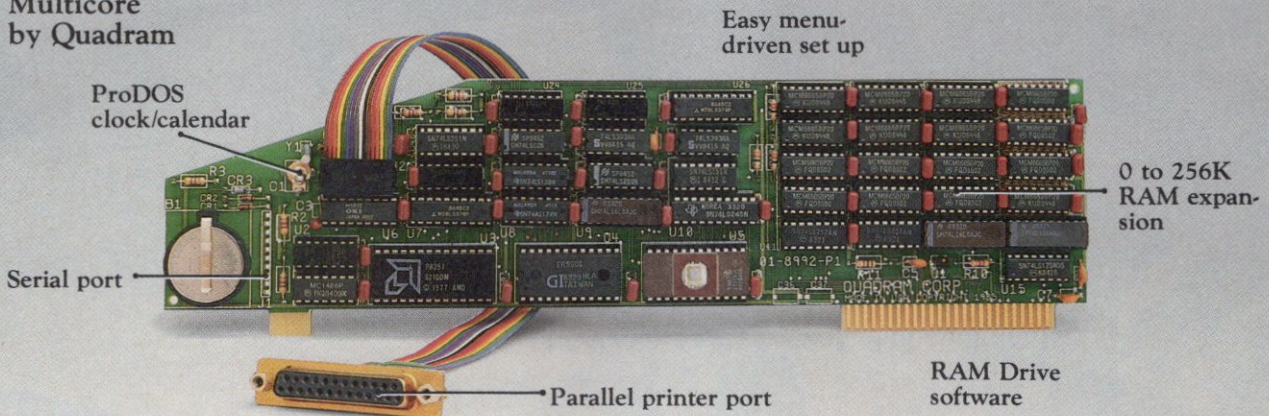

**Pro-DOS Clock/calendar**  
Long-life Lithium battery • Easy to use date/time software.

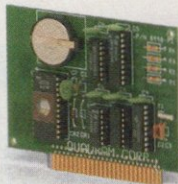

## Extended Multifunction Card

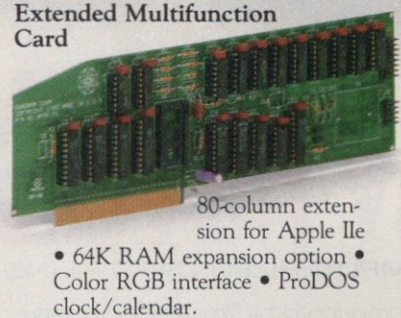

80-column extension for Apple IIe  
• 64K RAM expansion option • Color RGB interface • ProDOS clock/calendar.

## Serial Interface Adapter



Serial printer or communications interface • Supports graphics for Apple Imagewriter and Scribe printers  
• Apple Super Serial Card compatibility  
• Easy "switchless" serial configuration.

## Buffered Serial Interface Adapter



Serial printer or communications interface • Supports graphics for Apple Imagewriter and Scribe printers, including color and hires • Hardware print buffer with 64K to 256K RAM • Easy "switchless" serial configuration.

Apple, Apple II, IIe, II+ are trademarks of Apple Computer Corp.

**QUADRAM**  <sup>TM</sup>  
An Intelligent Systems Company

CIRCLE 139 ON READER SERVICE CARD

# INK - JET TALK

## ► APPLEWORDS BY STEVE ROSENTHAL

A short glossary of terms for use with 'Meet the Ink Jets,' page 48

### A SIZE

The standard American  $8\frac{1}{2} \times 11$ -inch size for office paper. Most Apple software that doesn't offer a choice of paper formats assumes you will use this size paper. All common ink-jet printers can use A-size paper.

### A4

The designation for standard-size office paper in international metric sizes. An A4 sheet is  $210 \times 297$ mm, or a little taller and narrower than the  $8\frac{1}{2} \times 11$ -inch sheet used in this country.

### ABSORBER PAD

A replaceable paperlike element that soaks up ink an ink-jet printhead sprays out as it goes through its automatic cleaning cycle.

### CHARACTER MATRIX

The set of dots that form each character. Ink-jet printers for Apple computers often use a matrix as dense as  $11 \times 12$  dots, enough to make the characters look less computerlike.

### CLAY PAPER

A type of paper for use with many color ink-jet printers. Clay paper is less absorbent than normal papers, and it causes less spreading, or wicking, of the ink. The ink used with it must be of the surface-drying type.

### CONTINUOUS STREAM

An ink-jet technology that continually emits drops but diverts them from the paper when the drops are not needed to create the image. Large high-speed models for

minicomputers and mainframes use this technology, but printers normally used with Apple computers do not.

### dB OR DECIBEL

The measure of the noise a printer or other device emits. Ink-jet printers usually measure under 55 dB, which is about the level of conversation. An impact dot-matrix printer such as the Imagewriter reads as high as 85 dB.

### DOT-ADDRESSABLE

A mode or type of graphics that allows an Apple computer to specify to the printer exactly which dots to print and which to leave white. The printer can then duplicate the pixels or dots on the Apple screen, or use special software that produces even more complex images.

### DROP ON DEMAND

An ink-jet printing technology that produces and throws onto the paper only the ink droplets needed to form the dark parts of an image or character. This contrasts with *continuous flow* methods, which constantly create droplets but divert those not needed before they reach the paper.

### IMPULSE

Another term for the drop-on-demand technologies that send out ink dots only when needed to form spots on the paper.

### INK CARTRIDGES

The replaceable plastic containers of ink ink-jet printers use. Some cartridges, such as those for the Hewlett-Packard ThinkJet, contain the pen body that sprays the ink.

### ISO CHARACTER SETS

The various alphabets and symbols used in different

countries, as standardized by the International Standards Organization. Having more than one character set is helpful if you want to write additional languages. ASCII (the character set Apple computers use) is the ISO International Alphabet Number 5.

### LIGHTFAST

Inks that do not fade significantly during prolonged exposure to normal light. In ink-jet pigments, black inks are generally more lightfast than colors.

### LOGIC-SEEKING

On printers that operate bidirectionally (outputting characters right to left as well as left to right), having the printer's internal circuitry decide from which end to start printing the next line, so as to minimize wasted traveling time for the printhead. Logic seeking can significantly speed up operation when the output contains many short lines.

### NONCLOGGING

Ink-jet-printer designs that—to prevent the unused ink from drying out—do not need to be cleaned manually after each use. All models for use with Apples now claim to be nonclogging.

### NONIMPACT

Said of ink-jet printers because they do not physically hit against the paper or ribbon. The LaserWriter and the Scribe are also nonimpact printers.

### PIEZOELECTRONIC

An ink-jet technology using a crystal that moves in response to an electronic signal to snap the ink forward onto the paper. The Siemens printers for the Apple use piezoelectronic designs.

### PITCH

The distance, measured in the number of characters per unit (in the U.S., per inch), a printer produces. Ink-jet printers for the Apple can generally print 10, 12, or 15 characters to the inch.

### POLYESTER PAPER

A special paper that gives better results with ink-jet printers than does ordinary office bond. It is absorbent but does not encourage splotching or wicking.

### RESOLUTION

For an ink-jet printer, the number of dots it can print in a given distance (usually an inch). For desktop models used with an Apple, typically this will be about 96 dots per inch.

### SPARK

An ink-jet technology that uses the tiny blast wave from a small spark to throw the ink onto the paper. The HP ThinkJet uses a related method: The pulse warms a tiny heating element, which in turn vaporizes enough ink to cause the tiny blast.

### SUBTRACTIVE PRIMARIES

The three pigment colors that can combine to form the full-color range. They are cyan (a greenish blue), magenta (a reddish color), and yellow. Color ink-jet printers use these colors and their combinations to make color images.

### USASCII

The full name for the American version of the standard way of encoding characters as computer codes. It's more often seen as just ASCII. From the point of view of the rest of the world, it's the International Standards Organization International Alphabet Number 5.

+

# Beagle Bros Apple Software Report

Call 619-296-6400 or write for free Catalog

Ad Number 222—Page 1

"All the News That Fits"

Summer 1985

## NEW! ProDOS Disk with Tip Book!

### PRO-BYTER™

\$34.95 (Compatible with any Apple IIe, IIc or 64K II+/ProDOS™)

#### ALL-NEW—BYTEZAP PRO

Inspect ProDOS™ and DOS 3.3 disks at the byte level. Make changes, improvements and disk or program repairs that are normally impossible. An all-new program with instantaneous block-to-block (or sector-to-sector) viewing.



Pro-Byter has given me new VIM and VIGOR!

**DISK SEARCH:** Find any word or phrase on a disk. Automatically trace or search any file. Repair "zapped" disk bytes that might cause malfunction. Instant disk maps show which sectors or blocks any file occupies.

**CUSTOMIZE DISKS:** Easy instructions show how to make changes to disks, other programmers' programs, and DOS itself—a changed byte here and there can produce amazing results. Hey, this stuff is FUN!

#### NEW ProDOS UTILITIES

**MACHINE LANGUAGE SORT:** One CALL in your Applesoft program will alphabetize a list of words or numbers—*super-fast!* Works with normal string-arrays (AS(1), AS(2), etc.).

**CONVERTER:** Convert any Applesoft program line into machine code that can be CALLED by any Basic program.

**TEXT TYPER:** Read and print ProDOS text files (on your screen or printer) without having to boot another disk.

**MORE:** Put time and date of save in your disk catalogs. Print alphabetized lists of your ProDOS catalogs (including all hidden subdirectories). Make any Applesoft command work like any other. Scramble Basic so only you can read it...

#### MACHINE LANGUAGE EDITOR

If you type in machine language programs from magazines, you'll love being able to make corrections by inserting and deleting code (no machine language knowledge required).

This easy-to-use editor also serves as a neat two-way-scrolling memory scanner. (Find out what's really going on inside your Apple's head.) The Pro-Byter manual shows you where in memory to look to find some very interesting stuff.

#### PLUS ALL-NEW APPLE TIPS

From the authors of DOS BOSS (Bert Kersey and Jack Cassidy)—page-after-page of juicy tips, experiments and inside info about your Apple. Learn secrets about Apple's new ProDOS operating system and Apple disk structure.

The latest official version of ProDOS (V1.1.1 with the new "Bye" command) is included on the Pro-Byter disk.

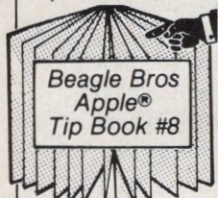

You get a GOLD MINE of tips, including: How to use memory like an extra disk drive (ProDOS lets you load & save files in RAM), How to disable the LIST command so it says "File Locked", How to disable or swap ANY command, How to change "Startup" to any name, How to personalize ProDOS catalogs...

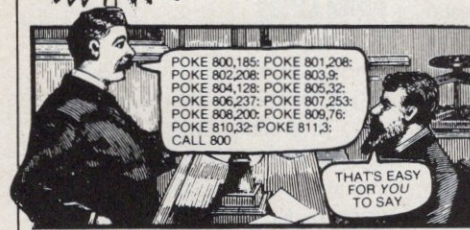

POKE 800,185: POKE 801,208:  
POKE 802,208: POKE 803,9:  
POKE 804,128: POKE 805,32:  
POKE 806,237: POKE 807,253:  
POKE 808,200: POKE 809,76:  
POKE 810,32: POKE 811,3:  
CALL 800

THAT'S EASY FOR YOU TO SAY

## UTILITY CITY™

\$29.50 (Compatible with any version of Apple II/ DOS 3.3)

A-Plus Magazine Readers' Choice 1985 Product of The Year

21 USEFUL UTILITIES: *List-formatter* puts each statement on a new line with indented loops and printer page breaks. *Multi-Cat* lets you create multi-column catalog printouts. *Filename Zap* allows invisible and trick file names, etc. Utility City is for beginning as well as advanced Applesoft programmers—very educational.

## SILICON SALAD™

\$24.95 (Compatible with any version of Apple II/ DOS 3.3)

#### OVER 100 PROGRAMS!

*Program Splitter* makes room for hi-res graphics in big programs. *Disk Scanner* finds bad sectors. *DOS-Killer* adds 2 disk tracks of disk space. *2-Track Cat* doubles the number of files. *Text Imprinter* converts text screen text to hi-res...

## NEW! 128K Extended Memory Utility!

### EXTRA K™

\$39.95 (Compatible with any Apple IIc or 128K IIe/ DOS 3.3 and ProDOS™)

#### PUT YOUR 128K TO WORK!

Even with 128K of memory, your Applesoft programs, pictures and variables only occupy and access the lower 48K. The EXTRA K disk contains several powerful programs that let you utilize all of that 128K capacity, speed and muscle.

#### EXTRA VARIABLES

Your Applesoft programs can now function undisturbed in main memory while all variables, strings and other data reside in your Apple's massive extra 64K. Everything functions normally—no special commands or procedures required.

#### EXTRA APPLE

EXTRA K lets you have two 64K Apples and programs in memory at once and switch between them at will. Plus, you can even have a ProDOS™ Apple and a DOS 3.3 Apple in memory simultaneously and swap files back and forth without subjecting yourself to Apple's *Convert* program.

#### EXTRA-FAST COPIES

Make disk copies fast and "on-the-spot" without re-booting! EXTRA K's "nibble copier" duplicates and verifies unprotected disks in 35 SECONDS instead of 1½ minutes. Thanks to your Apple's 128K, only 3-4 passes per disk are necessary.

#### EXTRA FEATURES

Compare any two disks, byte-for-byte. Create "dual personality" ProDOS/3.3 disks. Peek and poke auxiliary memory. Keep a live "logbook" of everything that has appeared on your text screen and review it when you want...

#### EXTRA SCREENS

Store all kinds of images in memory and display any one (all or part) instantly. Up to 7 hi-res pictures or 62 text screens can be stored at once. Call several pictures to the screen per second, opening up new Apple animation possibilities.



EXTRA K allows high-speed multi-screen switching.

## DOS BOSS™

\$24.00 (Compatible with any version of Apple II/ DOS 3.3)

#### CUSTOMIZE DOS 3.3

Change *Catalog* command to *Cat*, or "Syntax Error" to "Oops!", or anything you want. *Protect your programs:* An unauthorized Save-attempt can print "Not Copyable". List Prevention, other useful tips and fascinating experiments. DOS Boss will teach you a ton about Apple programming!

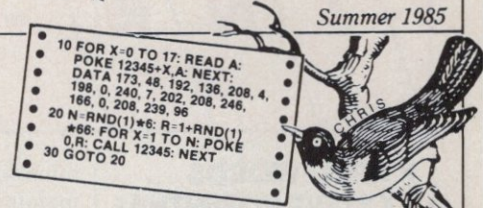

## New Applesoft Compactor/De-Bugger!

### D CODE™

\$39.95 (Compatible with any version of Apple II/ DOS 3.3 and ProDOS™)

#### PROGRAM PACKER

D CODE squeezes all of the wasted and unused bytes out of your Applesoft programs, saving valuable memory space and increasing your programs' speed and efficiency.

Automatically combine program lines, shorten variable names and/or remove REMarks. D CODE also uncovers wasted program lines that can't possibly be executed.

#### AUTO-PROOFREADER

Keyboard errors are caught as you type. If you enter an illegal program line, you are told immediately—before you (or worse—someone else) runs your program. Or you may simply type "CHECK" to scan an entire program in a couple of seconds and uncover potential crashes. If no mistakes are found, you get an immediate "NO ERRORS" message.

#### SUPER-TRACE

When a program stops or crashes, type "DUMP" to see the last 10-10,000 statements and line numbers that were executed, in the order executed—an instant program history.

D CODE features sophisticated "live" tracing too, with each executing statement, line number and selected variable values appearing in a window at the bottom of the screen.

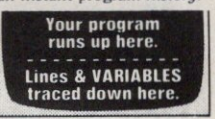

#### BREAKPOINTS

D CODE lets you set up de-bugging "breakpoints" so your program stops when you want. For example, you can ask that your program be stopped the moment X gets set to 99, or the 3rd time a particular program statement is encountered.

#### LIGHTNING-FAST FIND!

D CODE lets you find strings and variables fast—even large programs can be searched in about 2 seconds! All lines with a specified word are automatically listed with the word highlighted. This feature alone is worth the price of D CODE.

#### GPLE COMPATIBLE

D CODE remains "transparent" to your programs and is fully-compatible with GPLE, Double-Take, ProntoDOS, etc.



- 1 HOME: HTAB 5: POKE 33,28: FOR C=1 TO 92: POKE 50,255-192\* (C-4 OR C-64)
- 9 J=J+1-31\*(J=31): PRINT CHR\$(9+(J=1)): SPC(2+(J<10))J: NEXT: PRINT
- 85 POKE 33,1: PRINT "JULY..AUG..SEPT...."

## Beagle GAMES

### I. O. SILVER™

\$29.95 (Compatible with any version of Apple II)

#### HI-RES STRATEGY!

I. O. SILVER is both a thinking person's strategy game and a fast-action arcade game. Your job is to create a hi-res "Super Computer" on the screen while avoiding a pesty gang of computer bugs. I. O. Silver's Strategy Workshop lets you plan your moves before each level. Excellent high-speed animation and hi-res action. Great for ages 12 & up.

SOURCE CODE: Programmers can get fully commented I. O. Silver Source Code on three 2-sided disks for \$30. Ordering info comes with the game.

## BEAGLE BAG™

\$29.50 (Compatible with any version of Apple II)

#### 12 GREAT BASIC GAMES

Voted by Apple software buyers to *Softalk's* "Top-30 Most Popular" list, Beagle Bag is one of the best Apple game bargains on the market today. All games are LIST-able, so you can see what makes them work, or make changes.



The Apple Programmer's Best Friend

BEAGLE BROS, INC.

3990 OLD TOWN AVENUE, SUITE 102C  
SAN DIEGO, CA 92110 PHONE 619-296-6400

# Beagle Bros Apple Software Rep

**Public Notice**

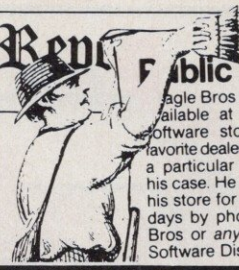

Beagle Bros products are available at most Apple software stores. If your favorite dealer doesn't have a particular disk, get on his case. He can have it in his store for you in 2 or 3 days by phoning Beagle Bros or any U. S. Apple Software Distributor.

Ad Number 222—Page 2

"All the News That Fits"

## Print Pictures on Your Printer! TRIPLE-DUMP™

\$39.95 (Compatible with any version of Apple II / DOS 3.3 and ProDOS™)

### PRINT ANY APPLE IMAGE

TRIPLE-DUMP lets your dot matrix graphics-capable printer print (1) Hi-Res and Double Hi-Res graphics. (2) Lo-Res and Double Lo-Res graphics. (3) Forty and 80-Column text screen text.

All kinds of images can be transferred to your printer with absolutely no programming knowledge. Or you can call Triple-Dump's routines from your own Applesoft Basic programs.

TRIPLE-DUMP gives you a full range of special effects—crop, rotate, magnify, compress, adjust density, etc.

### GIANT BANNERS TOO

Print big signs and messages of all kinds (with 8½" high letters) on any kind of dot-matrix or letter-quality printer.



## Hi-Res Shapes and Fancy Type! APPLE MECHANIC™

\$29.50 (Compatible with any version of Apple II / DOS 3.3)

### HI-RES SHAPE ANIMATION

Your drawings are converted into hi-res "shape tables" so your programs can perform animation with Apple's built-in DRAW & XDRAW commands. *List and Learn* disk demos teach you how to create your own animated hi-res programs.

"Use Apple Mechanic routines & fonts in your programs without fear!"

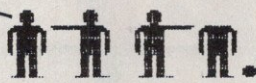

"Just credit Beagle Bros on your disk and manual!"

### FANCY DISPLAY TYPE

Six proportionally-spaced hi-res screen-display fonts (both large and small) are included on the Apple Mechanic disk—

**WESTERN: KLMN**  
**apple: ABCDEFG**  
**STENCIL: ABCDE**

26 more typefaces are available on our *Apple Mechanic Typefaces™* disk (sold separately: \$20.00).

16-COLOR DOUBLE HI-RES GRAPHICS!

## BEAGLE GRAPHICS™

\$59.95 (Compatible with Apple IIc or 128K IIe / DOS 3.3 and ProDOS™)

### DOUBLE HI-RES

Access 16 hi-res colors and 560 (honz.) x 192 (vert.) pixels (twice normal resolution) on your Apple IIc or 128K IIe.

AS AN ARTIST, you can draw, fill and label double hi-res pictures using just the keyboard, or your AppleMouse™, joystick, Koala Pad™ or Graphics Tablet. Easy-to-use icon-assisted *Cut & Paste* features make graphic manipulations easy. Any image section may be altered or re-located.

OR, AS A PROGRAMMER, you get 33 new commands for drawing, filling and manipulating double-res images. You can convert normal programs and pictures to double-res, save and load any image section, compress picture data to 1/3 disk space, produce double-res "slide shows" and more.

EXCELLENT REVIEWS—see Jan-85 *A-Plus* Magazine.

## BEAGLE BASIC™

\$34.95 (Compatible with unenhanced Apple IIc or 64K II+ / DOS 3.3)

### BETTER APPLE BASIC

Put Applesoft in RAM so you can change and improve it. Add new commands to Basic, like *ELSE, SWAP, TONE...*

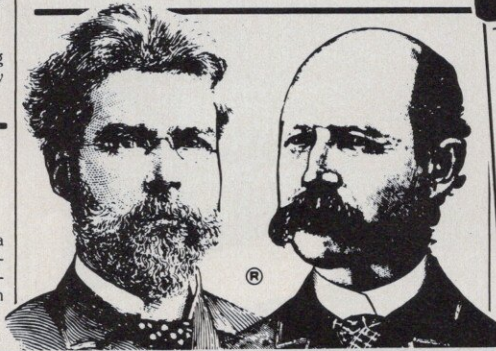

The Apple Programmer's Best Friend

BEAGLE BROS, INC.

3990 OLD TOWN AVENUE, SUITE 102C  
SAN DIEGO, CA 92110 PHONE 619-296-6400

## APPLE™

\$49.95 (Compatible with any version of Apple II / DOS 3.3 and ProDOS™)

### THE APPLE PROGRAM EDITOR

APPLE is Beagle Bros' "GLOBAL PROGRAM LINE EDITOR", the most popular, efficient way to edit Applesoft programs. APPLE works like a *word processor* for Basic program lines.

### INSERT & DELETE

Now you can *quickly* make changes to your programs. No more awkward "escape-editing" to make changes. No more hassles with extra spaces in quote statements. No more slow "cursor-tracing" to the end of a line before pressing Return.

### SEARCH & REPLACE

Find every occurrence of a string or variable in your programs. Or *replace* any word with any other. For example, change all X's to ABC's, or all "HORSE" strings to "COW".

### FUNCTION KEYS

Define your own Apple "function keys". For example, ESC-1 can Catalog drive 1, ESC-N can clear the screen and type your name and address, etc. Customize your Apple with a set of ESC functions that perform any set of tasks that you want.

## DOUBLE-TAKE™

\$34.95 (Compatible with any version of Apple II / DOS 3.3 and ProDOS™)

### 2-WAY SCROLLING

Listings and disk Catalogs scroll both up and down, making file names and program lines easier and faster to find. You change scroll-direction with the Arrow keys. Machine language listings and Hex-Ascii dumps scroll two-ways too.

### BETTER LIST FORMAT

Double-Take's easy-to-read listings have each Applesoft program statement on a new line for *fast* program reading.

### BONUS FEATURES

A\$="ABC" ← VARIABLE-DISPLAY: Instantly prints X=3.14159 all of your program's variables in the order used, with their current values.  
Y=255  
A\$: 5 10 150 ← CROSS-REFERENCE: Alphabetizes X: 10 20 3000 every variable your program uses, and Y: 5 40 55 60 displays them with their line numbers.  
Plus AUTO-LINE-NUMBER, improved Re-Number, Hex-Dec Convert, Program Stats, eliminate /re-define the cursor...

## FATCAT™

\$34.95 (Compatible with any version of Apple II / DOS 3.3 and ProDOS™)

### APPLE-DISK LIBRARIAN

Organize your disk library! FATCAT enters all of your ProDOS and 3.3 disk catalogs into one or more "Master Catalog" for fast searching, sorting and printing. Find the files you're looking for and eliminate space-wasting duplicates.

You can update your Master Catalog at any time by simply letting FATCAT read in your new or altered disks.

### ALPHABETIZE FILE NAMES

FATCAT will sort your ProDOS and 3.3 disks so they catalog in alphabetical order. Or you can re-arrange file names in any order. *Compare* any two files too, and find the differences.

## DISKQUIK™

\$29.50 (Compatible with Apple IIc or 128K IIe / DOS 3.3)

### DOS 3.3 IN-MEMORY DISK DRIVE!

DISKQUIK makes your Apple IIc or 128K IIe think it has an extra drive connected to Slot 3. It's just like using a super-fast (hard-disk speed), silent drive. Catalog with a "CATALOG.S3" command. Save and load all kinds of files to and from RAM with normal commands (holds about *half* the data of a floppy).

MANY USES: For example, load often-used programs into memory when you boot, so they are ready to use.

## PRONTO-DOS™

\$29.50 (Compatible with any version of Apple II / DOS 3.3)

### TRIPLE-SPEED DOS 3.3!

ProntoDOS lets you load & save files at triple speed. Hi-res pix, for example, load in under 3 seconds.

### MORE RAM & DISK SPACE

Create high-speed bootable disks with 15 extra sectors of space. Move DOS 3.3 to your Language Card (64K req.) for an extra 10K of usable memory. Also: Pronto's new *TYPE* command instantly displays DOS 3.3 text file contents.



Visa / MasterCard or COD, order Toll Free  
ALL 50 STATES / 24 HOURS (orders only)

1-800-227-3800 ext. 1607

Beagle Bros products are on the shelves at your local Apple Software Store.

- We also ship *FAST* via First Class Mail:
- Alpha Plot . . . . \$39.50
  - Apple Mechanic . . . . 29.50
  - A.Mech.Typefaces. 20.00
  - Beagle Bag . . . . 29.50
  - Beagle Basic . . . . 34.95
  - Beagle Graphics . . . . 59.95
  - D Code . . . . . 39.95
  - DiskQuik . . . . . 29.50
  - DOS Boss . . . . . 24.00
  - Double-Take . . . . 34.95
  - Extra K . . . . . 39.95
  - Fatcat . . . . . \$34.95
  - Flex Type . . . . . 29.50
  - Frame-Up . . . . . 29.50
  - GPLE . . . . . 49.95
  - I. O. Silver . . . . 29.95
  - Pro-Byter . . . . . 34.95
  - ProntoDOS . . . . 29.50
  - Silicon Salad . . . 24.95
  - Tip Disk #1 . . . . 20.00
  - Triple-Dump . . . . 39.95
  - Utility City . . . . 29.50

ADD \$1.50 FIRST CLASS SHIPPING (ANY SIZE ORDER).  
COD add \$3.00 / California add 6% / Overseas add \$4.00

NAME \_\_\_\_\_  
ADDRESS \_\_\_\_\_  
CITY \_\_\_\_\_  
STATE \_\_\_\_\_ ZIP \_\_\_\_\_  
VISA / M/CARD # \_\_\_\_\_  
EXPIRATION DATE \_\_\_\_\_



MAIL DIRECTLY TO BEAGLE BROS.  
WE PROCESS ALL ORDERS IMMEDIATELY.

© 1985, Beagle Bros, Inc.

# ► Exploring AppleWorks

When AppleWorks, an integrated word processor, spreadsheet, and database manager for the Apple II, was introduced a year ago, it was a real sleeper, but late last year it skyrocketed up to the top of the charts and has stayed there ever since. If you're one of the many people who have bought

AppleWorks, you are probably interested in exploring all the facets of this versatile program. We first introduced AppleWorks a year ago in "Enter the

DOW/CLEMENT  
PHOTOGRAPHY

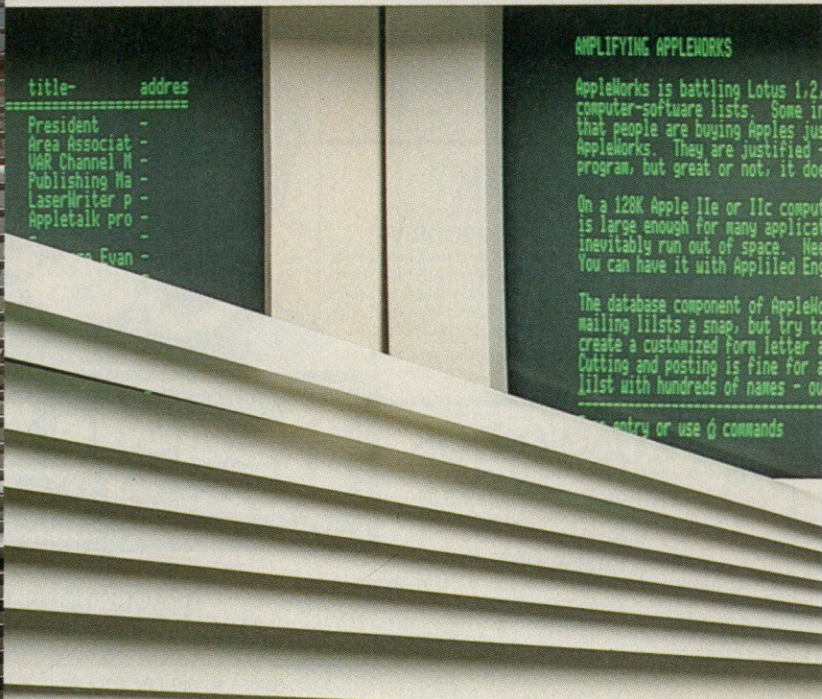

## Three Dimensions of AppleWorks,”

(July 1984, pages 41–44). This month

we present three articles to help

AppleWorks owners get the most from

their investment. The first article,

“Amplifying AppleWorks,” covers a

wide variety of add-on software prod-

ucts such as spelling checkers, mail-

merge programs, graphics programs,

and others. The second article, “Busi-

ness AppleWorks,” teaches you how to

set up sample records for a small business. The final article is “Per-

sonal AppleWorks,” which takes a look at how to use AppleWorks

for recording and analyzing home finances.



PART I  
BY MICHAEL CALLERY

# AMPLIFYING

# AppleWorks

Bigger desktops,  
mail merge,  
spelling  
checkers,  
and  
more

AppleWorks has overtaken Lotus 1,2,3 in the top spot on the computer-software lists. Some industry analysts contend that people are buying Apples just so they can use AppleWorks. They are justified—AppleWorks is a great program, but, great or not, it does have its limitations.

On a 128K Apple IIe or IIc computer, your AppleWorks desktop is large enough for many applications, but serious users inevitably run out of space. Need a larger work space? You can have it with Applied Engineering's RamWorks.

The database component of AppleWorks makes working with mailing lists a snap, but try to use your mailing list to create a customized form letter and you'll go bananas. Cutting and pasting is fine for a couple of items, but for a list with hundreds of names—ouch! Two products can come to your rescue: HabaMerge from Haba Systems and Megahaus' MegaWorks.

Can't spell? At least two spelling checkers can proof your AppleWorks

text files: The Sensible Speller from Sensible Software and Megahaus' MegaWorks.

Want to visualize your spreadsheet? GraphWorks from PBI can convert an AppleWorks spreadsheet into a graph.

By increasing the versatility of AppleWorks, any of these programs can increase your productivity.

#### Spreading the Spreadsheet

The AppleWorks desktop resides in RAM, and its size depends on the amount of RAM in your system. On a 128K Apple IIe and on Apple IIc computers, the standard desktop gives you an active memory of 55K.

If you use AppleWorks primarily for word processing, you shouldn't have severe memory problems—55K is on the hefty side for a text file. If you do happen to fill the desktop, you can split the document into chapters or sections of

manageable size. It's more difficult to split a database or spreadsheet file, though. If you must split a database, you'll have to do all searches and reports twice, once for each separate file. Similarly, if you split a spreadsheet, you can cut and paste a section of one spreadsheet into a second spreadsheet to carry a balance line into a third, but the cut-and-paste process is annoying if you must do it each time you use the spreadsheet.

To get a larger AppleWorks work area on a IIe, you can increase the amount of RAM available to the program by replacing your Extended 80-Column Card with a compatible, but larger-capacity, card. Apple IIc owners can purchase products that plug into the main circuit board to increase system RAM.

The increased-capacity card I tested was RamWorks from Applied Engineering. The basic card has 64K of memory just like the Apple Extended 80-Column Card, but you can add additional 64K RAM chips to extend the



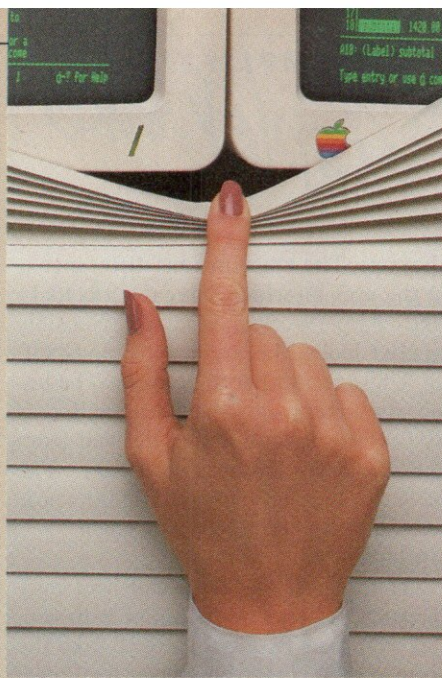

card's capacity to 128K. If you have greater memory needs, you can add a circuit board that plugs into RamWorks piggy-back fashion for an additional 128K of memory on the card. If you need still more memory, RamWorks does accept the more expensive 256K RAM chips (like those used in the Macintosh) for a total of one megabyte of memory. Furthermore, you can mix 64K and 256K chips, which gives you an incredible range of memory options.

Pumping up your 80-Column Card is the easy part. Unfortunately, your Apple won't be able to notice the extra memory unless you modify your software to recognize it. Applied Engineering sells software that allows its card to work with DOS 3.3, ProDOS, Pascal, CP/M, AppleWorks, and VisiCalc.

The DOS 3.3, Pascal, ProDOS, and CP/M software allows you to set up a RAMdisk, a portion of RAM that looks to the Apple like a normal floppy disk. You can transfer programs or data files to the RAMdisk with the FID program supplied by Apple on the DOS 3.3 System Master disk, or the ProDOS Filer. All disk operations become incredibly fast with the RAMdisk.

The computer doesn't actually operate faster than usual; only disk operations accelerate, a result of the RAMdisk's absence of slow mechanical parts. When you turn your computer off, or if there is a power outage, all data on the RAMdisk will be lost. You must remember to copy data from the RAMdisk to a floppy disk before turning your system off.

A RAMdisk does not increase the size of your AppleWorks desktop, but Applied Engineering's AppleWorks Expand does. This program modifies your AppleWorks start-up disk to use all the memory on the 80-Column Card. Your desktop can be as large as 736K when you have a one-megabyte RamWorks card. You'll note no real difference in AppleWorks, although the 736K Avail. notice at the bottom of the

AppleWorks screen may startle you.

Once you have exceeded the 55K limit of a standard AppleWorks desktop, you will not be able to load the file back into a standard Apple, and unless you have a larger-capacity disk drive, you cannot save a file that is larger than 140K. In practice, these numbers are actually smaller. AppleWorks does not let you store the full 140K capacity of an Apple floppy, nor does it allow you to create a full 55K spreadsheet. The actual capacity depends on what else you do with your desktop and files.

With the prices of hard disks falling daily, you should consider a hard disk if you need large files. One warning, though: AppleWorks must recalculate, search, and sort at the standard Apple speed. You'll have time for a coffee break—and more, in fact—with a 736K spreadsheet.

Accelerators such as the McT Speedemon should help speed up recalculation. Other accelerators, such as Titan's Accelerator with its own RAM, will not help, nor will you get the extra desktop space. These devices use only the RAM on the accelerator card, not the extra RAM on the 80-Column Card (see "The Endless Apple, Part II," *A+*, March 1985, pages 147–163).

#### Mail Merging

The most glaring omission in AppleWorks is a mail-merge capability. Mail merging is the ability to take a database file (a list of names, addresses, and other information) and combine it with a letter or other document. A mail-merge program assures that the proper "dummy statements" in the document are replaced by the information in the database file. Thus, a letter's sal-

utation might read, "Dear %NAME,.". The mail-merge program can find Arthur Jones in a database file, replace the %NAME, and print Dear Arthur Jones,. For a few letters, mail merge is more trouble than it is worth, but for a mailing to a users' group, a church's membership, or your entire client list, it is a godsend.

The simplest way to merge a database (the mailing list) and a document (the letter) in AppleWorks is to cut and paste the information from the database to the document, a tedious task indeed. HabaMerge and MegaWorks can both save you from this drudgery by producing mail-merged documents, but they are different in operation and capabilities.

#### HabaMerge

HabaMerge combines a database and documents you've produced with the AppleWorks word-processing program. When HabaMerge finds a ^1 in your document file, it brings in the first field of your database file. You can have as many as nine fields in your database. When you've printed out the first letter, HabaMerge produces another letter, using the second record of the database file, and so on until it's produced a letter for each record in the database. You can choose to print to the screen or to the printer, and the printer options allow for single or continuous forms.

If you want to produce a mailing to only a selected portion of your database, you must use AppleWorks' sorting capabilities and create a subset database to use in the mail merging. HabaMerge does not merge the actual database file, but works with a Print to Disk file. If you change your database in any way, you must create another disk file for mail merging.

In addition to facilitating mail merging, HabaMerge also allows you to print mailing labels from your database file. The mailing-label Print function is quite flexible and should accommodate most types of commer-

cially available continuous-form mailing labels.

### MegaWorks

MegaWorks' mail-merge function is conceptually similar to that of Haba-Merge. You must first prepare a document and a database file. With MegaWorks, you have to prepare both files with AppleWorks' word-processing program. Where you want a merge into your document, you must include something like Dear \$\$Name, where \$\$Name represents a name in a name field in the database. The dollar signs are essential.

If you want to use an existing database file, you must cut and paste the appropriate records into the word-processing program and then save the list from the word-processing program. MegaWorks requires special characters to delimit the records. The documentation does a good job of explaining the process of constructing the list or database file.

When you have created and saved your list and your document, you must exit from AppleWorks and boot MegaWorks. Selecting merge two AppleWorks documents from the MegaWorks main menu gets you a prompt for the name of the files to be merged and ultimately produces a third AppleWorks word-processor document that contains the merged documents. To print your form letter, you have to return to AppleWorks and use the standard AppleWorks word-processor printer functions.

### Spelling Made Simple

AppleWorks uses the ProDOS operating system, and any spelling checker that can check ProDOS files should be able to check AppleWorks files. The popular Sensible Speller from Sensible Software is available in a ProDOS version that works with AppleWorks files. MegaWorks features an AppleWorks spelling checker in addition to mail merge.

Both are stand-alone programs; that is, you cannot operate the spelling checker from within AppleWorks but must save your file, exit, and boot the spelling checker. Both show you errors in context, with small pieces of text surrounding the apparently misspelled word. Both allow you to substitute the word in the checker's dictionary for the misspelled word without typing it. And both allow you to add words to the dictionary so that words you frequently use that are not in the main dictionary will not be flagged as misspelled.

If the two programs sound similar,

# AMPLIFYING AppleWorks

they are. The most obvious difference is in the user interface. MegaWorks looks like AppleWorks, whereas Sensible Speller looks like, well, Sensible Speller. There is another difference. The basic dictionary of Sensible Speller is 80,000 words long and is derived from the *Random House Dictionary*. The MegaWorks dictionary is 50,000 words long, and its heritage is not given.

### GraphWorks

Your AppleWorks spreadsheet may be immediately understandable to you, but your boss may not want to take the time to appreciate your clever formulas. He or she may prefer a quick overview. With GraphWorks, you can graph your AppleWorks spreadsheets—and we all know what a picture is worth.

As with the mail-merge programs, you must restart your computer to use GraphWorks. You cannot cut and paste a piece of a spreadsheet into GraphWorks. If you need the charts GraphWorks can produce, you'll have to live with this inconvenience.

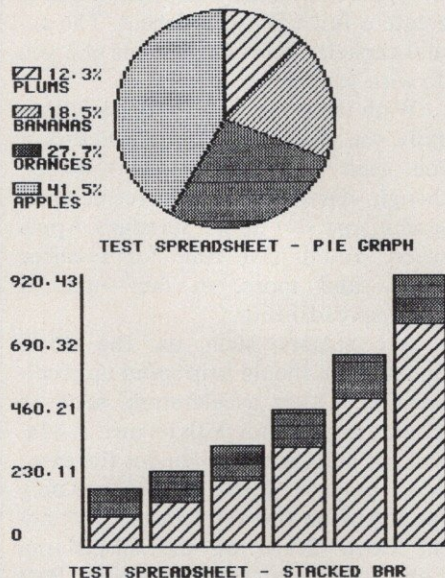

After you select a range of values and specify which type of graph you wish to produce with GraphWorks, pressing G gets you an instant graph of your data.

The introductory screen of GraphWorks looks like AppleWorks' main menu. The first time you use it, you must configure the program, specifying where the data disk will be and your printer configuration. After configuration, you will choose Add files to the Desktop, just as in AppleWorks. Your

spreadsheet cannot be larger than 12K, or at least the data must be stored within the first 12K of the spreadsheet.

After loading the data, you enter the graphing portion of the program by choosing Work with one of the files on the Desktop from the GraphWorks main menu. The screen mimics AppleWorks' spreadsheet screen, but none of the AppleWorks spreadsheet-editing functions are available. If you want to change a value, you'll have to return to AppleWorks.

GraphWorks allows you to select (with an inverse cursor bar) a range of up to 24 values from the spreadsheet. The values can be arrayed in rows or in columns but must be consecutive. Cells within the selected range that contain blanks or text are graphed as a 0. Next, you must specify the type of graph you wish to produce: pie, line, bar, or stacked bar. Pressing G gets you an instant graph of the data. Upon exiting from the graphing screen, you can select another type of graph or an additional range of data. GraphWorks allows you to make line or bar graphs of up to six ranges of data points, with each range shown in a different symbol or pattern.

When the graph is to your liking, you can print it out. You cannot save graphs to disk or merge them with other AppleWorks documents, however.

### Pretty Printing

Most of the current crop of dot-matrix printers allow users to load special fonts. You can use these fonts instead of the normal printer typestyle to achieve more attractive documents. Once you've loaded the fonts into the printer, they are accessible with commands such as those for underlining or boldfacing.

Why would you want a user-defined font? One possible application is for foreign-language word processing. Although most modern printers can print a few letters special to foreign languages—letters with accents, umlauts, and so on—you may not find all the characters or marks you need. Your user-defined font could contain these extra characters. Another use might be for mathematical symbols. Although the screen may show  $d_2$ , your printer will print  $\Delta^2$ .

I tested Vilberg Brothers DMP Utilities with my Apple IIc and ImageWriter. The disk contains a variety of ready-to-use fonts and provides a utility for converting DOS Toolkit or Higher Text small fonts to the DMP Utility format. If you still need additional spe-

# CONROY-LA POINTE<sup>SM</sup> INC.

All Rights Reserved © 1984 by Conroy-LaPointe, Inc.

TELEX 910 380 3980

ALL MAIL: Conroy-LaPointe, Inc.  
12060 SW Garden Place, Portland, OR 97223

ORDER NOW (800) 547-1289

FOR YOUR APPLE

MACINTOSH		COMPUTERS		BUSINESS SOFTWARE		UTILITIES SOFTWARE	
							
<p><b>ASSIMILATION, Turbo Touch</b> \$ 129 \$ 89</p> <p><b>BLUECHIP, Millionaire, Barron, Tycoon, ea.</b> \$ 60 \$ 37</p> <p><b>CENTRAL POINT, Copy II Mac or MacTools, ea.</b> \$ 40 \$ 24</p> <p><b>CONROY-LA POINTE, Diskettes,</b></p> <p>10 pak, SS/DD, w/Flip-Pak \$ 60 \$ 25</p> <p><b>CONTINENTAL, Home Accountant</b> \$ 100 \$ 65</p> <p><b>CREATIVE SOLUTIONS, MacForth Level I</b> \$ 149 \$ 95</p> <p><b>CREIGHTON, Home Pak or Mac Office, ea.</b> \$ 39 \$ 26</p> <p>Mac Spell + \$ 99 \$ 60</p> <p><b>CSD, MacLion</b> \$ 379 \$ 239</p> <p><b>DOW JONES, Market Manager Plus</b> \$ 249 \$ 159</p> <p><b>EXPERTTELLIGENCE, ExperLogo</b> \$ 150 \$ 95</p> <p><b>FIRST BYTE, Smooth Talker</b> \$ 150 \$ 95</p> <p><b>FORETHOUGHT, Fact Finder</b> \$ 150 \$ 95</p> <p><b>HABA, DS/DD Ext. Disk Drive, 800K</b> \$ 550 \$ 479</p> <p><b>HAYDEN, Sargon III</b> \$ 50 \$ 31</p> <p><b>HUMAN EDGE, Mind Prober</b> \$ 50 \$ 29</p> <p><b>INFOCOM, Hitchhiker's Guide</b> \$ 40 \$ 25</p> <p><b>INNOVATIVE, Flip-n-File, 40</b> \$ 30 \$ 19</p> <p><b>KOALA, Mac Vision</b> \$ 400 \$ 229</p> <p><b>LIVING VIDEOTEK, Think Tank</b> \$ 145 \$ 83</p> <p><b>LOTUS, Jazz</b> \$ 595 \$ 395</p> <p><b>MEGAHAUS, Megafilier</b> \$ 195 \$ 125</p> <p>Megamerge \$ 125 \$ 80</p> <p><b>MICROSOFT, Business Pak</b> \$ 595 \$ 395</p> <p>Multiplan, Word, or File, each \$ 195 \$ 125</p> <p><b>MILES, Mac the Knave, v. 1</b> \$ 39 \$ 25</p> <p><b>MONOGRAM, Dollars &amp; Sense</b> \$ 150 \$ 89</p> <p><b>NOVATION, Smartcat Plus Modem w/Software</b> \$ 499 \$ 349</p> <p><b>ODESTA, Helix</b> \$ 395 \$ 259</p> <p><b>PENGUIN, Graphics Magician</b> \$ 50 \$ 32</p> <p><b>PROVEU, Overvue</b> \$ 295 \$ 185</p> <p><b>SIMON &amp; SCHUSTER, Typing Tutor III</b> \$ 60 \$ 37</p> <p><b>SOFTW. PUBL., PFS: File &amp; Report Combo</b> \$ 175 \$ 105</p> <p><b>SOFTWARE ARTS, TK Solver</b> \$ 249 \$ 159</p> <p><b>STATE OF THE ART, Electronic Checkbook</b> \$ 80 \$ 50</p> <p><b>STONEWARE, DB Master</b> \$ 195 \$ 125</p> <p><b>TELOS, File Vision</b> \$ 195 \$ 115</p> <p><b>WARNER, Desk Organizer</b> \$ 149 \$ 99</p>		<p><b>lie, ilc, Mac, Mac XL</b> IN STOCK, CALL</p> <p><b>FLOPPY DISK DRIVES</b></p> <p><b>MICRO-SCI, A2 Disk Drive, 143K</b> \$ 345 \$ 169</p> <p>A2 Controller Card \$ 100 \$ 60</p> <p>Half Height Drive for lie \$ 269 \$ 169</p> <p>Half Height Drive for ilc \$ 299 \$ 189</p> <p><b>RANA, Elite I, 163K, 40 Track</b> \$ 299 \$ 189</p> <p>Elite Controller \$ 145 \$ 79</p> <p><b>TEAC, T40 Half Ht, 163K, Direct</b> \$ 249 \$ 169</p> <p>Controller Card for T40 by ComX \$ 79 \$ 45</p> <p><b>HARD DISKS</b></p> <p><b>QUARK, QC10 for ilc/lie/ilc/MAC</b> \$1995 \$1595</p> <p><b>OTHER HARDWARE</b></p> <p><b>CCS, 7711 or 7710-A Interface, ea.</b> \$ 115 \$ 85</p> <p><b>CPS/EASTSIDE, Wild Card II (copier, +/e)</b> \$ 140 \$ 79</p> <p><b>COMX, 16K RAM Card (II +), 1 yr ltr w/ty</b> \$ 119 \$ 29</p> <p><b>HAYES, Mach II, II Joysticks (II +), ea.</b> \$ 119 \$ 79</p> <p><b>KENSINGTON, System Saver Fan</b> \$ 90 \$ 65</p> <p><b>KEY TRONIC, KB200 Keyboard (+)</b> \$ 298 \$ 179</p> <p><b>KOALA, Muppet Keys</b> \$ 80 \$ 44</p> <p>Touch Tablet w/Micro Illustrator (+/e) \$ 130 \$ 75</p> <p><b>KRAFT, Joystick (II/II + /lie)</b> \$ 50 \$ 35</p> <p><b>MICRO-SCI, 80 Col. Card + 64K RAM Card (lie)</b> \$ 199 \$ 89</p> <p><b>MICROSOFT, Premium Softcard (lie)</b> \$ 395 \$ 275</p> <p><b>ORANGE MICRO, Buffered Grappler Plus, 16K</b> \$ 209 \$ 159</p> <p>16K Buffer Board for Grappler Plus \$ 99 \$ 59</p> <p><b>PCPI, Applicard, 6 MHz, 14 features</b> \$ 375 \$ 250</p> <p><b>RH ELECT., Super Fan II w/surge protector</b> \$ 89 \$ 59</p> <p><b>TITAN, Accelerator lie</b> \$ 319 \$ 219</p> <p>128K RAM Card (II +) \$ 269 \$ 189</p> <p><b>TRACKHOUSE, Numeric Key Pad (lie)</b> \$ 100 \$ 50</p> <p><b>TG, Select-A-Port</b> \$ 40 \$ 26</p> <p><b>VIDEO 7, V Color 7 RGB Card</b> \$ 150 \$ 99</p> <p>V Color lie \$ 200 \$ 139</p> <p>V Color lie \$ 250 \$ 169</p> <p><b>VIDEK, UltraTerm (II + /lie)</b> \$ 379 \$ 229</p> <p>VideoTerm 80 Col. Card (II + /lie) \$ 279 \$ 175</p> <p><b>WICO, Smartcard (spec. II/II + /lie)</b> \$ 199 \$ 159</p>		<p><b>ALS, Word or List Handler, ea.</b> \$ 80 \$ 36</p> <p>Handler Pak (Word/List/Spell) \$ 170 \$ 73</p> <p><b>APPLE, Appletworks</b> \$ 250 \$ 215</p> <p><b>ASHTON-TATE, dBase II (Req CP/M 80)</b> \$ 495 \$ 289</p> <p><b>BPI, AR, AP, PR or INV, each</b> \$ 395 \$ 240</p> <p><b>BRODERBUND, Print Shop</b> \$ 50 \$ 29</p> <p>Print Shop Graphics Library \$ 25 \$ 18</p> <p>Bank St. Writer or Speller, ea \$ 70 \$ 45</p> <p>Bank St. Combo (Writer &amp; Speller) \$ 140 \$ 85</p> <p><b>DOW JONES, Market Manager</b> \$ 249 \$ 159</p> <p>Market Analyzer or Microscope, ea. \$ 349 \$ 219</p> <p><b>HOWARD SOFT, Tax Preparer '85</b> \$ 250 \$ 165</p> <p><b>HUMAN EDGE, Sales or Mgmt Edge, ea.</b> \$ 250 \$ 165</p> <p><b>LIVING VIDEOTEK, Think Tank</b> \$ 145 \$ 89</p> <p><b>MECA, Managing Your Money</b> \$ 199 \$ 125</p> <p><b>MEGAHAUS, Megaworks</b> \$ 125 \$ 80</p> <p><b>MICRO PRO, WordStar</b> \$ 350 \$ 189</p> <p>WordStar w/ Starcard \$ 495 \$ 265</p> <p>WordStar Professional, 4 Pak \$ 495 \$ 265</p> <p>MailMerge, SpellStar, or StarIndex, ea \$ 99 \$ 54</p> <p>InfoStar and StarCard Combo \$ 595 \$ 295</p> <p><b>MICROSOFT, Multi-Plan (Ap DOS)</b> \$ 95 \$ 62</p> <p><b>QUARK, Word Juggler &amp; Lexicheck (lie/ilc)</b> \$ 189 \$ 129</p> <p><b>SENSIBLE, Sensible Speller</b> \$ 125 \$ 79</p> <p><b>SIERRA/ON-LINE, Screen Writer II</b> \$ 130 \$ 79</p> <p><b>SOFTWARE PUBL., PFS: File or Write, each</b> \$ 125 \$ 79</p> <p>PFS: Graph or Report, each \$ 125 \$ 79</p> <p><b>SPRINGBOARD, Newstrum</b> \$ 50 \$ 32</p> <p><b>STONEWARE, DB Master, v. 4 +</b> \$ 350 \$ 225</p>		<p><b>EPSON, Graphics Dump</b> \$ 15 \$ 7</p> <p><b>FUNK, Sideways</b> \$ 60 \$ 37</p> <p><b>HAYES, Terminal Prog. for Smartmodem</b> \$ 99 \$ 65</p> <p><b>MICROSOFT, Full Line in Stock</b> CALL</p> <p><b>OMEGA, Locksmith</b> \$ 100 \$ 70</p> <p><b>PENGUIN, Complete Graphics System II</b> \$ 80 \$ 49</p> <p>Graphics Magician \$ 60 \$ 40</p> <p><b>QUALITY, Bag of Tricks</b> \$ 40 \$ 29</p> <p><b>UNITED SWI, ASCII Express-The Pro</b> \$ 130 \$ 82</p> <p><b>UTILICO, Essential Data Duplicator III</b> \$ 80 \$ 49</p> <p><b>HOME &amp; EDUCATIONAL</b></p> <p><b>BEAGLE BROS., Full line IN STOCK</b> CALL</p> <p><b>BRODERBUND, Print Shop</b> \$ 50 \$ 29</p> <p><b>CONTINENTAL, Home Accountant</b> \$ 75 \$ 43</p> <p><b>KOALA, Full line IN STOCK</b> CALL</p> <p><b>MICROSOFT, Typing Tutor II</b> \$ 25 \$ 17</p> <p><b>MONOGRAM, Dollars &amp; Sense (lie)</b> \$ 100 \$ 59</p> <p>Dollars &amp; Sense (lie) \$ 120 \$ 69</p> <p>Forecast \$ 60 \$ 38</p> <p><b>SCARBOROUGH, Mastertype</b> \$ 40 \$ 25</p> <p>Build-A-Book \$ 40 \$ 25</p> <p>Your Personal Net Worth \$ 80 \$ 50</p> <p><b>SIERRA/ON-LINE, Homeward</b> \$ 70 \$ 45</p> <p><b>SIMON &amp; SCHUSTER, Typing Tutor III</b> \$ 60 \$ 37</p> <p><b>PLUS: BARRONS, CBS, DAVIDSON, EDU-WARE, HARCOURT, LEARNING CO., TERRAPIN</b></p> <p><b>RECREATIONAL SOFTWARE</b></p> <p><b>BLUECHIP, Millionaire or Barron, ea.</b> \$ 50 \$ 32</p> <p><b>DATASOFT, Aztec or Zaxxon, each</b> \$ 40 \$ 27</p> <p><b>ELECTRON, ARTS, Sky Fox &amp; others, ea.</b> \$ 40 \$ 29</p> <p><b>HAYDEN, Sargon III (Chess)</b> \$ 50 \$ 30</p> <p><b>INFOCOM, Zork I, II, or III, ea</b> \$ 40 \$ 25</p> <p><b>ORIGIN, Ultima III</b> \$ 60 \$ 37</p> <p><b>SPECTRUM, Transylvania</b> \$ 35 \$ 24</p> <p><b>SPECTRUM HOLOBYTE, Gato</b> \$ 40 \$ 25</p> <p><b>SPINNAKER, FULL LINE IN STOCK</b> CALL</p> <p><b>SUB LOGIC, Flight Simulator II</b> \$ 50 \$ 30</p> <p><b>PLUS: BRODERBUND, DATAMOST, MUSE, SIR-TECH</b></p>	

DISKETTES		MODEMS		PRINTERS		PRINTER INTERFACES AND BUFFERS	
<p><b>* CONROY-LAPOINTE™ DISKETTES *</b></p> <p>We guarantee these top quality products with our name. 5 YEAR LIMITED WARRANTY.</p> <p>10 ea. SS/SD, (Apple, etc) 35 Trk /W/FLIP BOX \$ 12</p> <p>100 ea. SS/SD, (Apple, etc) 35 Trk \$ 99</p> <p>1000 ea. SS/SD, (Apple, etc) 35 Trk \$ 840</p> <p>10 ea. SS/DD, 3 1/2" (MAC, H/P), /W/FLIP BOX \$ 25</p> <p>50 ea. SS/DD, 3 1/2" (MAC, H/P) \$ 115</p> <p>100 ea. SS/DD, 3 1/2" (MAC, H/P) \$ 229</p> <p><b>SINGLE-SIDED, DOUBLE DENSITY</b></p> <p>CDC, 10 ea. SS/SD, 40 Trk (Apple, etc) \$ 45 \$ 19</p> <p>DYSAN, 10 ea. SS/SD, (Apple, etc.) \$ 40 \$ 27</p> <p>MAXELL, 10 ea. SS/SD, MD1 (Apple) \$ 47 \$ 19</p> <p>VERBATIM, 10 ea. SS/SD, MD515-01, (Apple) \$ 49 \$ 19</p> <p><b>3 1/2" MICRO DISKETTES</b></p> <p>CONROY-LAPOINTE, 10 ea. DS/DD, w/Flip Box \$ 29</p> <p>MAXELL, 10 ea. SS/DD (MAC, H/P) \$ 60 \$ 35</p> <p>MEMOREX, 10 ea. SS/SD (MAC, H/P) \$ 60 \$ 33</p> <p>VERBATIM, 10 ea. SS/DD (MAC, H/P) \$ 65 \$ 32</p> <p><b>* GENERIK DISKETTES *</b></p> <p>Top quality, w/jackets, no labels. Quantity discounts. 90 day "No Hassle, money back guarantee."</p> <p>100 ea. SS/SD, 35 Track (Apple, etc) \$ 80</p>		<p><b>ANCHOR, Signalman Mark XII</b> \$ 399 \$ 259</p> <p><b>HAYES, 2400B External Modem</b> \$ 899 \$ 699</p> <p>Smartcom II Software (IBM/MAC) \$ 149 \$ 107</p> <p>Smartmodem 1200 (External) \$ 599 \$ 419</p> <p>Micromodem lie w/Smartcom (AP) \$ 329 \$ 239</p> <p><b>NOVATION, Apple Cat II 300 Baud (AP)</b> \$ 389 \$ 219</p> <p>212 Apple Cat, 1200 Baud (AP) \$ 595 \$ 419</p> <p>SmartCat Plus w/software (MAC) \$ 499 \$ 349</p> <p><b>PROMETHEUS, 1200 Standalone Modem</b> \$ 495 \$ 345</p> <p>ProModem 1200 w/software (MAC) \$ 549 \$ 429</p> <p>ProModem 1200A (AP) \$ 449 \$ 349</p> <p><b>MONITORS</b></p> <p><b>AMDEK, Color 300 - Comp/Audio</b> \$ 349 \$ 249</p> <p>Color 600 - Comp/VCR/RGB/Audio \$ 525 \$ 375</p> <p>Color 600 - Hi Res/RGB/Audio \$ 599 \$ 399</p> <p>300A - 12" Amber \$ 199 \$ 135</p> <p>300G, 12" Green \$ 179 \$ 119</p> <p><b>PRINCETON, HX-12 - Hi Res/RGB</b> \$ 795 \$ 489</p> <p>SR-12 - Hi Res/RGB \$ 799 \$ 599</p> <p><b>QUADRAM, Amberchrome, 12"</b> \$ 250 \$ 159</p> <p><b>ZENITH, ZVM122 - 12" Amber</b> \$ 159 \$ 95</p> <p>ZVM123 - 12" Green \$ 149 \$ 89</p> <p>ZVM124 &amp; ZVM 135 \$ 20-30% OFF</p> <p><b>CABLES</b></p> <p><b>ASTAR, RF Modulator for T.V. (Apple)</b> \$ 35 \$ 20</p> <p><b>COMPUABLE, Mac/Hayes Smartmodem Cable</b> \$ 32 \$ 25</p> <p>RCA, Monitor Cable \$ 15 \$ 9</p>		<p><b>APPLE, Imagewriter</b> \$ 6995 \$6500</p> <p>Laserwriter CALL</p> <p><b>EPSON, RX / FX Series - In Stock</b> CALL</p> <p>LX80 - 100 cps DQ/16 cps NLO \$ 299 CALL</p> <p>JX80 - Color Printer, 160 cps. \$ 699 CALL</p> <p>LQ1500 - 200 cps DQ/67 cps LQ \$1295 CALL</p> <p><b>OKIDATA, Okimate 20 - Color, Hi Res</b> \$ 268 \$ 208</p> <p>182 - 120 cps/80 col \$ 299 \$ 239</p> <p>92 - 160 cps/80 col/para. \$ 499 \$ 399</p> <p>93 - 160 cps/136 col/para. \$ 799 \$ 639</p> <p>2410 Pacemark - 350 cps/para. \$2995 \$1975</p> <p><b>PANASONIC, P1090 - 80 cps/10"</b> \$ 349 \$ 249</p> <p>P1092 - 180 cps/10" \$ 599 \$ 459</p> <p><b>QUADRAM, Quadjet - Inkjet Color</b> \$ 895 \$ 395</p> <p><b>STAR MICRO, SG10 - 120 cps DQ/30 cps NLO</b> \$ 299 \$ 249</p> <p>SG15 - 120 cps DQ, 30 cps NLO, 16K \$ 499 \$ 419</p> <p>SD10 - 160 cps DQ, 40 cps NLO \$ 449 \$ 379</p> <p>SD15 - 160 cps DQ, 40 cps NLO, 16K \$ 599 \$ 509</p> <p>SR10 - 200 cps DQ, 50 cps NLO \$ 649 \$ 549</p> <p>SR15 - 200 cps DQ, 50 cps NLO, 16K \$ 799 \$ 679</p> <p><b>TOSHIBA, 351 - 288 cps</b> \$1895 \$1369</p> <p><b>LETTER-QUALITY:</b></p> <p><b>JUKI, 6300 - 40cps/para.</b> \$ 995 \$ 795</p> <p>6100 - 18 cps/para/3 pitch \$ 599 \$ 439</p> <p>Sheet Feeder for 6300 (single) \$ 275 \$ 225</p> <p><b>PANASONIC, P3151 - 22 cps/15 1/2"</b> \$ 699 \$ 539</p> <p><b>TOSHIBA, Prop. spacing &amp; hi-res graphics:</b></p> <p>1351 - 192 cps DQ &amp; 100 cps LQ \$1895 \$1369</p> <p>1340 - 144 cps DQ &amp; 54 cps LQ \$ 799 \$ 619</p> <p>Bi-direction Tractor Feed \$ 195 \$ 175</p>		<p><b>ASSIMILATION, Mac to Epson Conn I/F</b> \$ 89 \$ 69</p> <p>Daisywheel Connection \$ 99 \$ 79</p> <p><b>EPSON, Parallel Interface for LQ1500</b> \$ 100 \$ 79</p> <p>Serial Interface Board \$ 130 \$ 110</p> <p><b>MPC, Apple II F &amp; Cable for Epson &amp; Gemini</b> \$ 90 \$ 49</p> <p><b>OKIDATA, Plug'n Play, Tractors, Okigraph, ea.</b> CALL</p> <p><b>ORANGE MICRO, Grappler Plus for Apple</b> \$ 145 \$ 99</p> <p>Serial Grappler \$ 119 \$ 79</p> <p>Buffered Grappler Plus, 16K \$ 209 \$ 159</p> <p><b>QUADRAM, Microfazers, Full line IN STOCK</b> CALL</p> <p>Microfazers 8K, P-P, w/copy \$ 189 \$ 139</p> <p><b>STAR MICRO, Serial I/F &amp; Cable</b> \$ 144 \$ 119</p> <p>Mac/Star Interface \$ 100 \$ 89</p> <p><b>ACCESSORIES</b></p> <p><b>CURTIS, Diamond, 6 outlets, switched</b> \$ 50 \$ 29</p> <p>Emerald, 6 outlets, 6' cord \$ 60 \$ 35</p> <p>Ruby, 6 outlets, 6' cord, filter \$ 90 \$ 52</p> <p>Sapphire, 3 outlets, w/filter \$ 80 \$ 46</p> <p><b>EPD, Lemon, 6 outlets/wall</b> \$ 45 \$ 29</p> <p>Lime, 6 outlets/cord \$ 70 \$ 45</p> <p>Orange, 6 outlets/cord \$ 100 \$ 60</p> <p>Peach, 3 outlets/wall \$ 60 \$ 39</p> <p><b>INNOVATIVE, Flip-n-File 50 (disk holder)</b> \$ 22 \$ 15</p> <p><b>KENSINGTON, Printer Stand</b> \$ 30 \$ 19</p> <p><b>NETWORK, Wiretree, 4 outlet, w/fit &amp; surge</b> \$ 70 \$ 39</p> <p>Wiretree Plus \$ 100 \$ 59</p>	

**ORDERING INFO & TERMS.** MAIL TO: 12060 SW Garden Place, Portland, OR 97223 - include telephone number. Check your figures for Shipping, Insurance and Handling (SIH). All items usually in stock. NO C.O.D. Cashiers checks, money orders. Fortune 1000 checks and government checks honored immediately. Personal and other company checks - allow 20 days to clear. Prices reflect 3% cash & Conroy-LaPointe Credit Card discount, so ADD 3% to above prices for VISA/MasterCard/American Express. Your cards NOT charged till we ship. Add SIH CHARGES: U.S. Mainland, 3% (\$5 minimum) for standard UPS ground; UPS Blue, 6% (\$10 min); for U.S. Postal APO or FPO or Alaska, 6% (\$10 min); Canada, 12% (\$15 min); Foreign orders except Canada, 18% (\$25 min). Monitors by Postal or to foreign countries, 30% (\$50 min). Orders received with insufficient SIH will be refunded. All prices, availability and specifications subject to errors or change without notice, so call to verify. All goods are new, include warranty and are guaranteed to work. Due to our low prices and our assurance that you will get new, unused products - ALL SALES ARE FINAL. We do not guarantee compatibility. Call before returning goods for repair or replacement. ORDER DESK HOURS - 6AM to 6PM PST, Monday through Friday, Saturday 10 to 4. EconoRAM™, Fastrak™, and Generik™ are trademarks of ComX Corporation.

**CASH-N-CARRY COMPUTER STORES, INC.**  
Retail Sales only. Store prices may vary.  
SAN FRANCISCO - 550 Washington Street (at Montgomery, opposite the Pyramid). Interstate 80 to Highway 480; take Washington Street Exit. CALL (415) 982-6212.  
PORTLAND, OREGON - At Park 217, Tigard at intersection of Highways 217 and 99W. CALL (503) 620-5595.  
SEATTLE, WASH. - 3540 128th Ave. SE, Bellevue 98006. In Loehmann's Plaza near Factoria Square, SE of Highway 405 & 90 and at SE 36th and Richards. CALL (206) 641-4736.

Mail To: 12060 SW Garden Place, Portland, OR 97223

CONROY-LAPOINTE CREDIT CARD

Send me a Conroy-LaPointe credit application form, so I can get cash discount prices with credit card convenience \$400 Minimum initial purchase

NAME \_\_\_\_\_

ADDRESS \_\_\_\_\_

CITY \_\_\_\_\_ STATE \_\_\_\_\_ ZIP \_\_\_\_\_

MasterCard VISA

CONROY-LAPOINTE CARD

NO SALES TAX

CALL (800) 547-1289

In Oregon: (800) 451-5151 (503) 620-9877

Foreign & Portland Residents Call

QUESTIONS (503) 620-9878

ORDER DESK HOURS Mon-Fri 6am to 6pm (PST) Saturday 10am to 4pm (PST) Weekdays Only (6am here 9am in New York)

cial characters, the Vilberg package includes an editor to customize a typestyle to your needs.

This program, and others like it, do not work directly with AppleWorks; rather, you use them before you enter AppleWorks to print. After you've loaded the printer with the font, AppleWorks uses the font like a special printer feature. You cannot, however, use the standard printer driver but must create a new printer driver that redefines one of the codes you don't normally use. This redefined command code changes the printer to the alternate font.

Applied Engineering's RamWorks is a boon to those who must use large files with AppleWorks. A fully configured one-megabyte RamWorks card costs about as much as an Apple IIe Starter System, however. Despite the high price, I like the product so much that I am buying one for my own system. Memory expansions smaller than one megabyte are also quite useful and provide the extra space necessary for many serious applications of AppleWorks.

If you already have an Extended 80-Column Card and don't want to sell it, you can cannibalize the card for RAM chips and transfer them to the RamWorks card for additional memory. If you work with DOS 3.3, ProDOS, Pascal, or CP/M programs, the RAMdisk utilities make this system even more attractive.

Both mail-merge products perform as advertised, but if you must create boilerplate letters with large blocks of text, only MegaWorks supports word-wrap when printing. Without word-wrap, you cannot merge anything that will push the line beyond the right-hand margin of your form letter. On the other hand, HabaMerge features sophisticated manipulation of data. You can, for example, extract a person's first name from a mailing list that stores only full names. HabaMerge also lets you print your mailing labels; with MegaWorks, you must print your labels from within AppleWorks.

Creating the mailing-list database in HabaMerge is easier than it is in MegaWorks, but in HabaMerge the database can have only nine fields, each as wide as your document. Because MegaWorks uses a word-processor file rather than a database file for the merge data, it is more flexible, if more cumbersome, to use. MegaWorks relies on the AppleWorks clipboard, so you will not be able to do large mailings in one pass.

AMPLIFYING

AppleWorks

## AppleWorks may spawn a whole industry of add-on products.

If you need spelling checking in addition to mail merging, MegaWorks may be your best choice. Sensible Speller can also check your AppleWriter 2.0 or other ProDOS text files, however, and has the larger dictionary.

GraphWorks is the first and, at this writing, only graphing program that works directly with AppleWorks. The 12K/24-point size limitations and the data setup requirements limit GraphWorks' use for many applications. Furthermore, because you cannot save a picture—only print it—you cannot use GraphWorks to create a disk-based slide show or bring the graph into a drawing program to beautify it. The latter ability may be essential for all but personal use, given the rough appearance of many GraphWorks graphs. If you can live with these restrictions, though, the product is solid and works well.

Finally, the Vilberg DMP Utilities can supply those characters you have always longed to see on your Apple or Epson FX or JX printer.

### More to Come

I've looked only at the first crop of AppleWorks add-ons here. The popularity of AppleWorks—with its inherent limitations—suggests that, like VisiCalc, AppleWorks will spawn a whole industry of add-on products. Keep your eyes on *A+*. You can be sure that we'll cover the latest products that enhance your use of AppleWorks. +

*Michael Callery spent a significant portion of the early 80s teaching the use of VisiCalc and creating custom models for the consulting firm of McMullen and McMullen. He is the coauthor of Apple Graphics: Tools and Techniques from Prentice-Hall.*

## ▶ PRODUCT INFORMATION

### RamWorks

Applied Engineering  
P.O. Box 768  
Carrollton, TX 75006  
(214) 492-2027

**List Price:** 64K, \$179; 128K, \$249; 256K, \$399; 512K, \$649; 1024K (1 M), \$1199; DOS/ProDOS RAM Drive, \$29; CP/M RAM Drive, \$29; AppleWorks Expand (128K), \$29; AppleWorks Super Expand, \$39

CIRCLE 415 ON READER SERVICE CARD

### HabaMerge

Haba Systems  
15154 Stagg Street  
Van Nuys, CA 91405  
(818) 901-8828

**List Price:** \$69.95

CIRCLE 416 ON READER SERVICE CARD

### MegaWorks

Megahaus  
5703 Oberlin Drive  
San Diego, CA 92121  
(619) 450-1230

**List Price:** \$125

CIRCLE 417 ON READER SERVICE CARD

### Sensible Speller

Sensible Software  
210 South Woodward, Suite 229  
Birmingham, MI 48011  
(313) 258-5566

**List Price:** \$125

CIRCLE 418 ON READER SERVICE CARD

### GraphWorks

PBI Software  
1155B-H Chess Drive  
Foster City, CA 94404  
(415) 349-8765

**List Price:** \$79.95

CIRCLE 419 ON READER SERVICE CARD

### Vilberg DMP Utilities

Vilberg Brothers Computing  
P.O. Box 4576  
Madison, WI 53711  
(608) 274-6433

**List Price:** \$50

CIRCLE 420 ON READER SERVICE CARD

### SpeeDemon

McT  
1745 21st Street  
Santa Monica, CA 90404  
(213) 829-3643

**List Price:** \$295

CIRCLE 421 ON READER SERVICE CARD

# It doesn't have to be complicated to be powerful.



The pen has always been one of the most powerful ways to exchange information and ideas. Yet it's not a complicated tool.

PFS®:WRITE is a word processing program that's so powerful, it can meet all your business writing needs. Yet it's so uncomplicated, it's amazingly easy to learn.

WRITE is designed for people without computer expertise. All instructions are written in plain English so you can be productive right away.

With just a few keystrokes, you can make insertions and deletions, create bold face type, even move whole blocks of text.

And if you ever need it, help is just a keystroke away.

Unlike most word processing software, WRITE prints exactly what you see on the screen. Since WRITE's screen resembles a standard sheet of paper, you'll always know what your document will look like *before* you print. With WRITE, it's easy to get it right the first time.

PFS:PROOF is the perfect companion to WRITE. PROOF checks WRITE documents for spelling, typographical errors, irregular capitalization and repeated words. All with just a touch of a key.

WRITE is fully integrated with the PFS Family of Software. So it's easy to use information from other PFS programs and get more done in less time. For example, you can produce personalized form letters complete with addressed envelopes from data stored with PFS:FILE. You can even add a pie chart to the letter, created with PFS:GRAPH, to further illustrate a point.

PFS — it's the powerful software that's simple to learn. It's the power of simplicity.

See your computer dealer for a demonstration and discover how powerful the power of simplicity really is.

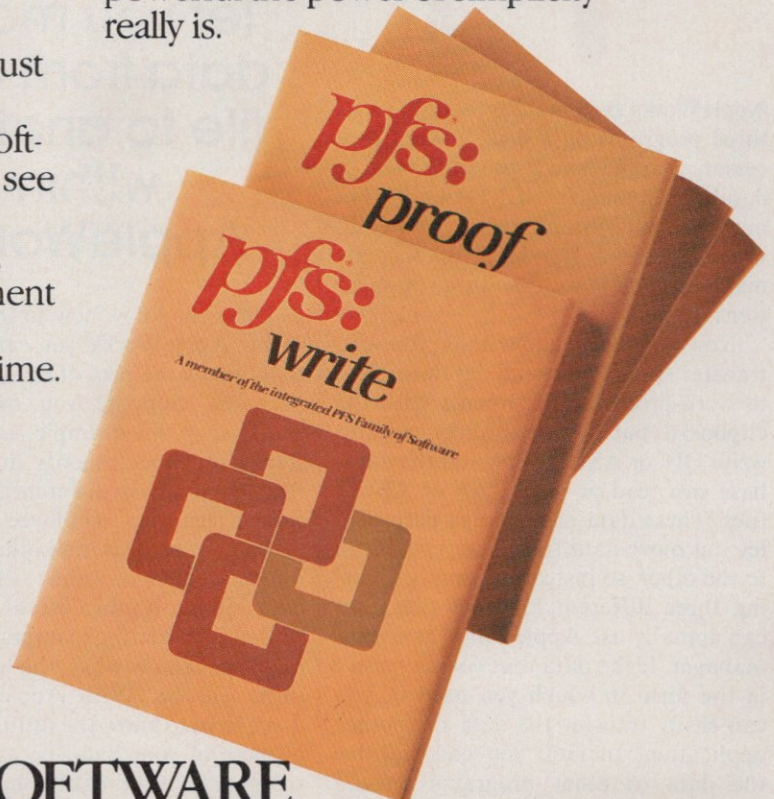

**PFS SOFTWARE**  
The Power of Simplicity™

PFS:WRITE runs on Apple IIc and IIe, \* IBM, \* Compaq, Tandy, \* Panasonic, Data General, Hewlett Packard, and other personal computers. \* PFS:PROOF also runs on these personal computers.  
© Software Publishing Corporation

PART II  
BY CHARLES RUBIN

# BUSINESS

# AppleWorks

Data-interchange pathways let you move data from one file to another within AppleWorks.

AppleWorks is generally thought of as three programs on a disk: a word processor, a spreadsheet program, and a database manager. Its Desktop file-management system and its ability to write and read standard file formats make it much more than three applications, though.

You probably know that you can transfer spreadsheet and database data to word-processor documents with the clipboard, but the spreadsheet can also write DIF or ASCII files, and the database can read or write DIF or ASCII files. These data-interchange pathways let you move data from one type of file to the other, so instead of simply creating three different kinds of files, you can actually use AppleWorks as a data manager. If the data that you have isn't in the form in which you need it, you can easily transfer the data to another application. In fact, you can transfer the data to other programs outside AppleWorks, so you can send files via modem, graph spreadsheet figures, or manipulate your data with more powerful spreadsheet or database programs.

Once you know how to transfer data within AppleWorks, you can use essentially the same pool of data for various purposes. Suppose you own an ice-cream shop, for example, and you have stacks of paper records in the office. Perhaps you have different folders for a vendor list, an employee file, some equipment records, and other groups of information. You want to organize this data and put it into a useful form, but if you're just getting computerized, you may not know what the most useful form will be. With AppleWorks you don't have to know the ultimate form or purpose of your data, because you can reorganize it so easily. Let's look at some examples.

#### Gathering Data with Lists

The first step in organizing data with AppleWorks is to gather it all in

one place so you can work with it. You can create one large database file that contains much of your basic business information and then reorganize it as you please. Names, addresses, and telephone numbers are a good place to begin. Two useful groups of information are vendor-related data and employee-related data, so you can create one large file for each group that contains as much information as possible.

To create one database file called Employees, establish categories (fields) for each record (entry). The categories in this example are Name, Address, City, State, ZIP, and Phone. This basic information is useful in both the Employees and Vendors files, but you need enter it only once. Once you have created these categories in the Employees file, you can save this file to disk. Then use the Name Change command to change the file name to Vendors and save it to disk. You now have two separate files on the disk; each of them contains the same categories, and you can add categories to get more specific information in each file. To the Employ-

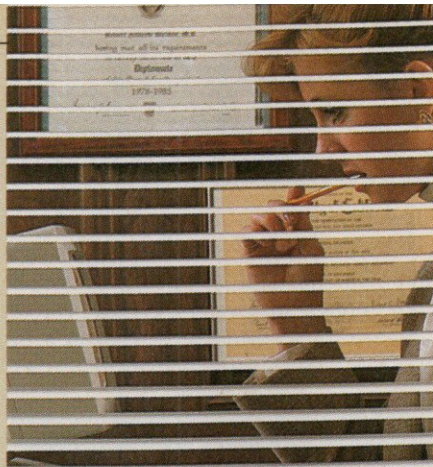

ees file, for example, you can add the following categories: Wage, Date Hired, Position, Social Security Number, Age, Experience, Education, Emergency Contact, and Emergency Phone. These categories allow the col-

lection and storage of archival employee information, similar to the data in a paper personnel file (see figure 1).

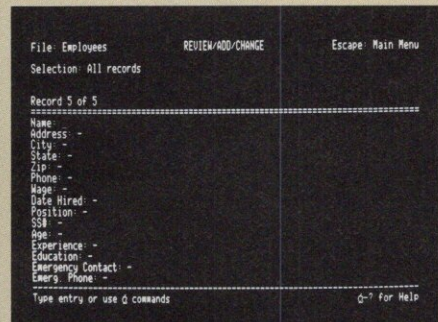

Figure 1: Categories for records in the Employees database file

For the Vendors file, you can add these categories: Product Name, Product Type, Vendor, Contact, Unit Cost, Model Number, Serial Number, Warranty Length, Date Purchased, and Terms. These categories let you store

data about products you sell, such as ice cream, as well as equipment and services (see figure 2).

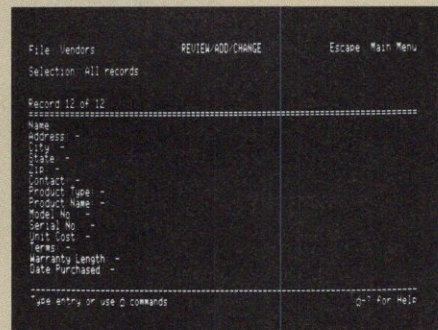

Figure 2: Categories for records in the Vendors database file

Consult records in these large files when you want specific data about a particular vendor or employee, or sort the records in these files to create other data-management tools. With the Vendors file, you can sort the records by product type and then total the Unit Cost category to determine how much

### Analyzing Inventory

Suppose, for example, that you want to devise an inventory tracking system. The Vendors file already lists the vendors and products you sell, so you can reuse that information as the basis of an inventory-valuation worksheet. The only data you need for the worksheet is the product name and the unit cost. Using the database's report-format screen to define a new table-style report, you can delete all the other categories of data. Although the Vendors file includes vendors of services (such as janitorial) and equipment, along with vendors of products, we're now interested only in products because they are the items whose inventory levels change.

Extracting the product-related data for the inventory file is an easy task. Using the record-selection rules on the Report Format screen, you can ask for records in which Product Type does not equal Service, and the program will deliver only the products that meet this criterion.

You can then print the two categories to a DIF (Data-Interchange Format) file on disk. AppleWorks asks you to enter a name for the DIF file—call it Products. Next, use the Escape key to return to the AppleWorks main menu and choose the option to create a new spreadsheet file from a DIF file. Type in the name of the source DIF file (Products), and then specify a name for the new spreadsheet (call it Inventory). The database information is now in a spreadsheet format (see figure 3). Some of the item names in certain rec-

ords may be wider than the spreadsheet's nine-character default column width, but you can easily widen columns to show all the data by using the Layout command.

The Inventory worksheet now contains product names and corresponding

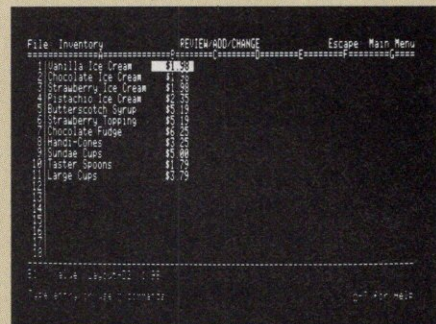

Figure 3: A spreadsheet created from a DIF file

unit-cost figures. The category names don't transfer from the database file in DIF format, so be sure to label these two columns before doing anything else. After that, label additional columns for Quantity, Unit Price, Total Cost, and Total Price. Then enter formulas that multiply Quantity by Unit Price (to calculate Total Price) and Quantity by Unit Cost (to calculate Total Cost), and the worksheet is almost complete. The only remaining formulas are the @SUM formulas, the result of which is visible at the bottom of the To-

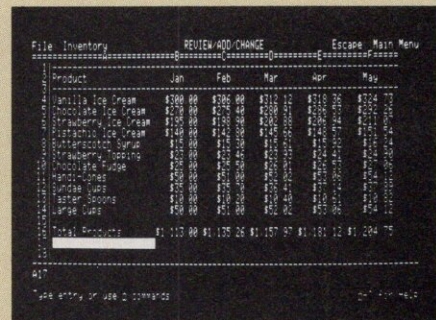

Figure 4: Inventory worksheet

tal Price and Total Cost columns—these columns give total cost and retail value of the inventory (see figure 4).

When you work with a file on the AppleWorks desktop, you can easily change its name and alter it to perform another function. For instance, the In-

ventory worksheet is safely on disk and loaded to the desktop. Using the Name Change command, you can rename the worksheet, modify it, and then save it to disk under its new name. Here are two more examples of ways to recycle previous data with AppleWorks:

The Inventory worksheet is a good place to keep track of total inventory values, but it can also be used as a worksheet during physical inventories. With the Name Change command, change the filename (you could call the new file Inv.Worksheet), and then use the Blank command to erase the entries in the Quantity column. Once you do this, you will be able to take a physical inventory and write in by hand the actual quantity of each item. You won't forget to count certain items because everything you buy is already listed on the sheet.

This basic information has another use: projecting expenses. Working with the Inventory file again, you can change its name to Projection, blank out all the columns except the Product Name column, and enter column labels for each month in the year.

As you go through the year, you can refer to vendor invoices or your checkbook to determine monthly expenses on

# BUSINESS AppleWorks

each item and salaries paid. Soon you'll have enough historical data to project future costs accurately. Don't stop with expenses and salaries—add a few rows

Product	Jan	Feb	Mar	Apr	May
Vanilla Ice Cream	\$388.00	\$386.00	\$312.12	\$310.26	\$324.73
Chocolate Ice Cream	\$278.00	\$278.48	\$288.31	\$286.53	\$292.26
Strawberry Ice Cream	\$195.00	\$198.90	\$202.09	\$206.24	\$211.07
Fritachio Ice Cream	\$148.00	\$142.00	\$149.26	\$148.97	\$151.54
Butterscotch Syrup	\$15.00	\$15.39	\$15.21	\$15.92	\$16.24
Strawberry Topping	\$23.00	\$22.46	\$23.33	\$24.41	\$24.90
Chocolate Fudge	\$26.00	\$25.29	\$26.51	\$26.73	\$27.06
Handi-Cones	\$59.00	\$51.00	\$52.82	\$53.06	\$54.12
Sundae Dips	\$35.00	\$35.70	\$36.41	\$37.14	\$37.89
Easter Spoons	\$18.00	\$18.20	\$19.48	\$19.61	\$19.82
Large Dips	\$59.00	\$51.00	\$52.82	\$53.06	\$54.12
<b>Total Products</b>	<b>\$1,113.00</b>	<b>\$1,125.26</b>	<b>\$1,157.97</b>	<b>\$1,181.12</b>	<b>\$1,204.75</b>

Figure 5: Use the Inventory file to record (and project) expenses (above), salaries, or income

at the bottom of the worksheet to track income each month. Subtracting total costs from total income enables you to track and project cash flow and to determine the best times in the future for advertising or expansion (see figure 5).

## Salary Projections

Data in the Employees file can be recycled the same way. Suppose, for example, that you've sorted through the database file and discovered that four employees have been with you for more than a year. You want to give them a raise, but you need to know the impact on the overall salary expenses.

The database records contain the salary information, but the database isn't exactly the ideal tool for doing this type of what-if analysis. To handle the problem, extract the data you need from the existing database file and transfer it to a spreadsheet.

Your first task is to define a report format. Call up the Report menu and choose the option to create a new table-style report. The Report Format screen shows the Employees file with all of its categories, although some of the categories will be off-screen to the right because all of them cannot be displayed at once.

For the salary-analysis spreadsheet, the only categories of information you need are Name, Wage, and Date Hired (for reference). Since you need to transfer only these categories to the spreadsheet, you should delete the other categories from the Report Format

## It takes only One Spelling Mistake to blow your image

No matter how much work you've put into that report, no matter how accurate your references and sound your conclusions, a single spelling mistake can destroy its credibility.

**HOW CAN YOU GUARD AGAINST THIS?** Simply check your paper with Sensible Speller™, the software program that is a virtual electronic dictionary. With tireless, efficient detachment, it will catch mistakes you would not notice. It will in fact display misspelled words in context, suggest the correct spelling, and allow immediate replacement of misspelled words with correct ones.

**WHAT IS THE SIZE OF SENSIBLE SPELLER'S VOCABULARY?** All 80,000 words of the official Random House Dictionary. And there's enough room left on disk to add thousands of your own words.

**HOW LONG DOES IT TAKE TO USE SENSIBLE SPELLER?** A ten-page document can be corrected in one or two minutes.

**ON WHAT COMPUTERS CAN YOU RUN SENSIBLE SPELLER?** On all Apple //c, //e, II + , and Apple-compatible computers.

**WHAT OTHER DICTIONARIES ARE AVAILABLE?** Black's Law Dictionary™, Sensible Technical Dictionary™, and Stedman's Medical Dictionary™ are available separately on diskette.

**WHERE MAY SENSIBLE SPELLER BE PURCHASED?** It is available at your dealer for \$125 in either the "IV"™ or ProDOS version.\*

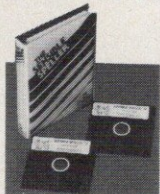
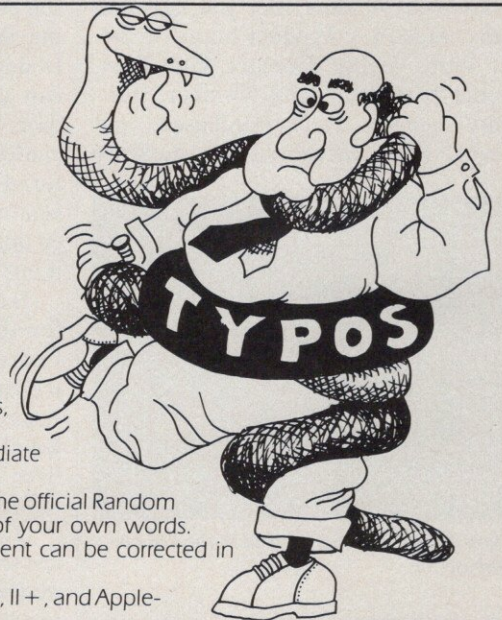

**SENSIBLE SPELLER ProDOS IS APPLEWORKS COMPATIBLE**



**Sensible Software, Inc.**

210 S. Woodward, Suite 229, Birmingham, MI 48011  
(313) 258-5566

\*Sensible Speller ProDOS works with the following word processors: AppleWriter-ProDOS version, AppleWorks (Apple Computer, Inc.), Format II Enhanced-ProDOS (Kensington Microwave), and others. Sensible Speller IV works with DOS 3.2 and DOS 3.3: AppleWriter (Apple Computers, Inc.), Bank Street Writer (Brodebund), Format II (Kensington Microwave), HomeWord & Screen Writer (Sierra On-Line, Inc.), PFS:WRITE (Software Publishing, Inc.), Word Handler (Silicon Valley Systems), CP/M-Wordstar (Digital Research Corp.-Micropro International), and others. All features are not available with CP/M, PFS:WRITE & Word Handler. Owners of trademarks indicated in parentheses.



# 12 Good Reasons Why RAMWORKS™ Is The Best Expansion Card For Your Iie

**1 APPLEWORKS MEMORY** Even though Ramworks enhances and expands a VAST ARRAY of other programs, Appleworks is our claim to fame. A 64K Ramworks will ADD 46K to your available desktop memory, a 128K Ramworks will ADD 91K, a 256K Ramworks will ADD 182K, and a 512K Ramworks will ADD 364K and a 1 meg Ramworks will give you nearly an 800K desktop. And it's all done automatically! When you plug in more memory chips into your Ramworks card, Appleworks will find them—automatically. Ramworks also increases the maximum number of records from 1350 to 4300.

**2 APPLEWORKS SPEED AND POWER** Ramworks does more than just increase the desktop memory (as if that weren't enough). With Ramworks, Appleworks will be able to run up to 20 times faster. If you buy a 256K or larger Ramworks card, Appleworks will automatically load itself in Ramworks. This greatly increases the speed at which Appleworks operates by eliminating all that nasty, time consuming disk access on Drive 1. These are but a few reasons why we say that Ramworks is Appleworks best friend.

**3 EXPANDABILITY** Ramworks was designed with the future in mind, as your needs increase, so can Ramworks. Clear instructions show you how to plug in more memory (up to 1 meg).

**4 SPEED** Today, as programs become more and more sophisticated, they inevitably become larger. And many of today's best selling programs (like Appleworks) won't fit in a 128K Apple, so many of these new larger programs continually go back to disk in search of more data. With Ramworks, you can have enough memory so that the entire program will be loaded into Ramworks' memory. This greatly increases the speed of software because your disk runs at 300 RPM, but Ramworks operates at the speed of light!

**5 COLOR** The same slot that's used for memory expansion is also the slot that's used for RGB color display, so all those lesser memory cards of yesterday make you decide in advance if you want RGB color. Only Ramworks lets you decide later to add RGB color. For only \$129, an RGB option can be added to Ramworks to give you double high resolution color graphics and 80 column text. All with a razor sharp, vivid brilliance that's unsurpassed in the industry. The RGB option does not waste another valuable slot, but rather plugs into the back of Ramworks and attaches to any Apple compatible monitor. Remember, you can order the RGB option with your Ramworks or add it on at a later date.

**6 COMPATIBILITY, OF THE SOFTWARE KIND** Programs like Appleworks, Magic Office System, Flasheal, The Spread Sheet, Diverse-A-Dos, Supercalc, Magicalc and many others automatically recognize all or most of Ramworks memory (512K is average). The simple fact is that Ramworks is compatible with more off-the-shelf software than any other RAM card. Ramworks is 100% compatible with ALL software written for the Apple 80 column and extended 80 column card. Additionally, Ramworks can emulate other RAM cards so software written for other cards will run without modification. Software written for RAMWORKS will not work on other cards. We can emulate others, but others can't emulate us.

**7 COMPATIBILITY, OF THE HARDWARE KIND** Unlike others, Ramworks is fully compatible with hardware add on's from other companies, like the Sider and Profile hard disks. And Ramworks was designed in accordance with the official expansion rules defined by Apple so you don't have to worry about compatibility problems. As you continue to expand and make your Apple more powerful with other expansion products from Applied Engineering, you'll appreciate how each product has extra features designed to work with Ramworks and other products to give you a total performance package that is more powerful than the sum of its parts.

**8 IT SELLS THE MOST** Popularity translates into great software support because software companies can't support all RAM cards, they can only support the ones their customers are likely to own. And software companies appreciate the fact that when they write software for Ramworks in the Iie,

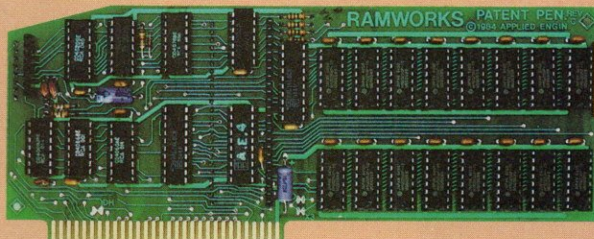

they're also writing software for our memory expansion card for the Iie, Z-RAM. And our customer list reads like the Who's Who of Apple computing with just about every software company in the land buying one, including Apple Computer (in the hundreds), Rupert Lissner, and Steve Wozniak (we didn't give one to Mr. Wozniak just to use his name, 2 one meg Ramworks were paid for at full price).

**9 IT'S FROM APPLIED ENGINEERING** Unlike most of the competition, we only make accessories for Apple, so we'll never spend your money on IBM product research. Applied Engineering's years of experience and wide product line really pays off, and because of our high sales levels we buy most of our I.C. chips factory direct. So don't let our low prices fool you, they're caused by high volume production. That's why we can offer the most memory for the least money. Guaranteed!

## 10 IT'S GOT IT ALL

- ✓ Sharp 80 Column Text
- ✓ Double high resolution graphics (with or without RGB option)
- ✓ User Expandable to 1 Megabyte
- ✓ Can Use 64K or 256K RAMS in any combination
- ✓ Adds Memory to Appleworks
- ✓ Accelerates Appleworks
- ✓ 100% Compatibility with All Iie software
- ✓ RAM Disk software available, compatible with Applesoft, PRO-DOS, DOS 3.3, and PASCAL (\$29)
- ✓ RAM Disk available for CP/M (\$29). (This program is included with our CP/M card)
- ✓ Visicalc preboot available (\$29)
- ✓ RGB option
- ✓ Takes only one slot
- ✓ 3 year no hassle warranty

**11 THE PATENT OFFICE HAS ONE** There are many advanced features on Ramworks, but two parts of the design are so advanced we applied for patents. One patent application deals with our ultra fast, ultra smooth 80 column screen display, and the other patent application deals with our ingenious way of dramatically reducing the power and heat of memory chips and improving reliability at the same time.

**12 HERE TODAY, HERE TOMORROW** In the seven years we've been making products for the Apple, we've seen a lot of companies come and go. Although nothing is forever, we're growing, expanding and we're profitable. And we are totally committed to Apple computing, which means you'll never run out of things to do with Ramworks. Or for that matter, reasons to buy one.

Ramworks™ with 64K .....	\$179
Ramworks™ with 128K .....	\$249
Ramworks™ with 256K .....	\$299
Ramworks™ with 512K .....	\$399
Ramworks™ with 1 MEG. ....	\$649
RGB Option (can be added later) .....	\$129

Call (214) 241-6060

9 a.m. to 11 p.m. 7 days a week or send check or money order to:  
Applied Engineering, P. O. Box 798, Carrollton, Texas 75006



MasterCard



Visa and

C.O.D. welcome. No extra charge for credit cards. Texas Residents add 5½% sales tax. Add \$10.00 if outside U.S.A.

**AE** APPLIED ENGINEERING  
"We Set the Standard"

# PRINT-IT!™

THE NEW APPLE\* COMPATIBLE SERIAL AND PARALLEL PRINTER INTERFACE



Go  
From Screen  
to Paper  
at the Touch  
of a Button!

The ONLY way to get fast, easy printouts  
of ANY screen, at ANY time,  
with ANY program.

Push the red button that comes with PRINT-IT! - Your program pauses instantly; touch RETURN and whatever is on your screen - text, graphics or both - is printed in color or black & white.

Whether your Apple II, II+, //e<sup>®</sup> or "look-alike" is for business or pleasure, you'll want the ability to pause and take snapshots of your screen displays and then continue from exactly where you paused, all at the touch of a button - games, business data, menus, educational instructions, graphics - even CP/M<sup>®</sup>. PRINT-IT! will print your screen at any time no matter what program you're running, as well as perform every function you expect of an intelligent printer card.

PRINT-IT! supports:

- Graphics - Low, high, double low, and double high resolution
- Text - 40 column as well as Apple //e and Videx<sup>®</sup> 80 column cards including the new Apple 80 column RGB card
- Software - Prints from ALL software, even allows any printer to be used directly from Apple MousePaint
- Printers - All of the most popular printers,<sup>③</sup> including color, are easily selected with a dip switch.

PRINT-IT!, complete with cable (serial or parallel), is available at your local computer store now! If they don't have it in stock, ask them to get it for you.

Can't find a local dealer? PRINT-IT! is available for \$199 directly from Texprint<sup>®</sup> Qualified educational and dealer discounts available.

**TEXPRINT**

Subsidiary of Computer Products Inc.  
220 Reservoir Street  
Needham Heights Ma. 02194  
Tel. (617) 449-5808

For information call Toll Free **1-800-255-1510**

① Visa, MC, AMX accepted. Add \$4 shipping and handling within USA. Mass res. add 5% tax  
② Apple II, II+, //e, and MousePaint are registered trademarks of Apple Computer, Inc.  
③ CP/M is a registered trademark of Digital Research  
④ Videx is a registered trademark of Videx, Inc.  
⑤ Apple DMP//IMAGEWRITER/SCRIBE, BMC, C. Itoh, Canon, Epson, Dataproducts, IDS, Tally, NEC, Okidata, Quadram, Panasonic, Radio Shack, Star Gemini, Transtar, Diablo plus many others.

screen, using the Delete command.

The database report at this point shows only the categories you want to transfer. All you have to do now is save the report to a DIF file on disk and use that DIF file as the source of a new spreadsheet file.

After the file is saved, return to the main menu and choose the option to create a new spreadsheet file from a DIF file. Enter the name of the DIF file and type a name for the new spreadsheet file (this name must be different from the DIF filename). The three categories of data now become three columns of data in a new spreadsheet. Before modifying the spreadsheet, insert two rows at the top and enter labels for the columns of data you have.

Next, insert columns for projected wage, hours worked, current weekly wage, and projected weekly wage. You might also add a column that shows the percentage of increase in pay. You can total the weekly wage columns at the bottom of the sheet to show the impact of the wages on your bottom line. You can now enter different hourly wages as projected raises and immediately see the impact on the total salary expense. You can also see what percentage of wage increase the figure represents.

## BUSINESS

# AppleWorks

Another nice thing about showing percentages of increase in wages is that you can equalize the percentage among the four employees, even though they

Name	Hire Date	Current Hourly	Proj Hourly	Hours/Week	Curr Total	Proj Total	Pct. Raise
Joe Wilson	Jun 18	\$3.65	\$4.15	48	\$145.80	\$158.80	13.78%
Lois Langston	Sep 12	\$3.58	\$4.08	48	\$141.84	\$155.84	14.25%
Otis Creedmore	Jun 1	\$5.75	\$6.58	48	\$235.80	\$255.84	13.84%
Roxanne Adanna	Sep 1	\$3.58	\$4.08	36	\$112.80	\$144.00	14.25%
<b>Totals</b>					<b>\$542.00</b>	<b>\$730.00</b>	<b>13.71%</b>

Figure 6: Salary-analysis spreadsheet

may be starting off with different wage levels (see figure 6).

The Employees file can also produce telephone lists, basic tax-information reports for your bookkeeper, and other groups of data. If your business has

fewer than 10 employees, you could easily use all 30 possible data categories in the AppleWorks database to gather a remarkably complete collection of information about employees, inventory, customers, or whatever. Once you have the basic collection of data, you can move sections of it to other files with other formats to suit your data-management needs. The examples here show files that are quite small—a few inventory items or a handful of employee names—but a typical small business has enough data to make these transfers well worth the time you would save if you didn't have to reenter redundant information each time you wanted to work with it in a different format.

AppleWork's data-interchange features can save time in big businesses, too. Department managers, secretaries, salespeople, controllers, and other employees can use AppleWorks to create personalized data-handling tools for their own situations. +

Charles Rubin's latest computer book, *AppleWorks*, will be published in July by Microsoft Press. He is also the author of *The Endless Apple* and writes features and reviews for various computer publications.

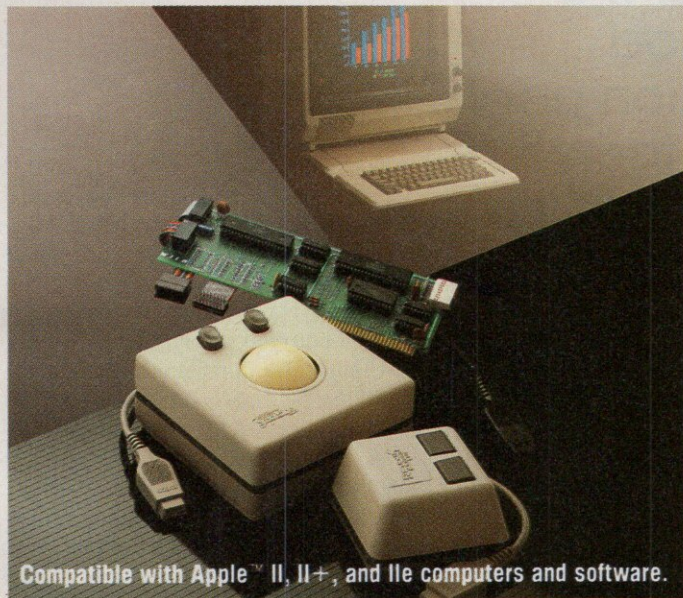

Compatible with Apple™ II, II+, and IIe computers and software.

## Finally.

# Mouse-type cursor control for virtually all your Apple II software.

We call it the SmartLine. You call it smart time.

Because the SmartLine actually cuts keystroke time and effort by 60%. That's a savings that will make your work far more productive and your software investment far more rewarding.

At the center of the system is the SmartCard™ — a fully programmable easily installed "computer within a computer" bringing state-of-the-art control to any Apple II software that accepts cursor control commands from the keyboard.

Use it with the SmartBall™ or SmartMouse™, the two most accurate, most sensitive optomechanical controls money can buy. You'll edit faster. Speed through spreadsheets. And stop on a pixel.

The new WICO SmartLine. It's the smartest move you can make.



**M.A.D. INNOVATIONS**

Microprocessor Applications Design

P.O. Box 13465 • Albuquerque, NM 87192

1-800-621-0660 ext. 22 • 24 Hour Order Line • MasterCard/VISA Accepted  
Order Now! N.M. residents include 4.63% sales tax. Add \$3 for shipping and handling.

Item No.	Description	Price
5020-74	SmartCard with Mouse for Apple IIe	\$150.00
5020-75	SmartCard with Ball for Apple IIe	\$150.00
5020-76	SmartCard with Mouse for Apple II/II+	\$150.00
5020-77	SmartCard with Ball for Apple II/II+	\$150.00
5010-30	WICO Joystick for Apple II, II+, IIe, IIc For Mouse and Trackball with SmartCard add	\$32.00 \$ 40.00

### The WICO SmartCard™

A "computer within a computer" with programmable microprocessor and memory, it's packaged with the SmartMouse or SmartBall, plus easy-to-use utility disk with set-up files.

### The WICO SmartBall™

Easier to use than a mouse, it requires far less space for operation while providing faster, more precise cursor movement with virtually all Apple II software.

### The WICO SmartMouse™

The only mouse designed for use with virtually all existing Apple II software.



SmartLine, SmartCard, SmartBall, SmartMouse, Apple are trademarks respectively of WICO Corporation and Apple Computer Inc. © 1985 M.A.D. INNOVATIONS

CIRCLE 338 ON READER SERVICE CARD

PART III  
BY CHARLES RUBIN

# PERSONAL

# AppleWorks

The secret is  
to build a  
good  
information pool  
and then  
know what to  
do with it.

AppleWorks' spreadsheet, database, and word processor together have enough features to help us perform a wide variety of personal tasks. The program's data-interchange facilities let us transfer data from one application to another, so we can recycle data instead of retyping it. The secret lies in building a good information pool to begin with and then knowing what to do with it later.

## Financial Facts

One handy type of file for personal use contains financial information. You may not be vitally interested in what your monthly income and expenses are, but you will need at least some of this data at tax time, and it's a lot easier to collect it as you go than to scrape it together at the last minute. Once you have it collected, you can use AppleWorks to analyze it in a variety of ways to help plan your financial future.

You can set up the main financial file as an AppleWorks database. The

initial file can be simple, and you can add to it or modify it as your needs and interest dictate. To begin, you can simply create categories to record the date, type, purpose, and amount of transactions and use a Tax category to specify whether each transaction is deductible. This simple file can then hold records of all your financial activity (see figure 1).

The best way to assemble the data to enter into this file is to consult your checkbook register, since most of us conduct at least 90% of our financial business through one or more checking accounts. Simply flip through the register a page at a time, entering the date, amount, type of transaction, and tax status. For the Type of Transaction category, the simplest distinction is between expenses and income.

You can sharpen these basic distinctions with the Purpose entry, however, so you can divide your expenses into a series of categories such as Utilities, Rent, Food, Cash, Gifts, and so forth. When you apply these categories, though, be consistent—if you decide to list food costs under Food, don't forget and call such a transaction Groceries, or you'll have trouble finding it later (see figure 1).

What such a file does for you immediately is organize all your expenses so you can sort through them to determine your financial picture. At any time, you can easily use database reports to find out how much you've spent on a given category, how many tax deductions you have to date, or what your total monthly expenses are.

It's easy to define and store specific reports. Suppose, for example, that every month you'd like to know your total monthly expenses, your year-to-date income, and your year-to-date tax deductions. You can define a custom



report format for each of these areas.

To figure total monthly expenses, you can define the report, using the record-selection rules. You select all records where Type is equal to Expense. Then you define a category total in the Amount category. When you print this report, you see a list of all your expenses, with the total of the Amount category entries at the bottom of the report. You can name this report Expenses, and AppleWorks will list it as an option on the Report menu from then on. You can define and store up to eight report formats with the database (see figure 2).

If you've entered the expenses haphazardly and you want to see them in date order, you can arrange the report in the Date category before you print it. After the first month, you will be getting more than a month's worth of

transactions. Each report is easy to define. You simply use the record-selection rules to specify records where Tax equals yes or Type equals Income, and the database will select the records you want. You can then define a category total for the Amount category in each case, and your printed report will show the total value of these entries (tax deductions or income).

A final point to remember about database reports is that you can examine them on the screen. You may not want to waste paper when you're just checking to see what your year-to-date earnings are. AppleWorks displays only the first 80 characters of a report's width, however, so if your report format is wider than 80 characters, you won't see every category. In most cases, you can make individual categories narrower or delete unnecessary ones from a report to squeeze it into the 80-character limit for screen printing.

Because of these sorting and reporting capabilities, you can use this one database file to do with AppleWorks most of the basic things that stand-alone home accounting programs do. You won't have fancy graphs showing expense levels, but you can sort through records just as well.

#### Budgeting

Creating a budget is tricky to do with AppleWorks. You can include an extra category in the file for projected expenses, but the disadvantage of this approach is that certain monthly expenses (such as food) actually consist of several individual transactions, but

your projections will be by the month, not by the transaction.

What you can do, though, is transfer some of the data from the main file into a budget spreadsheet. By transferring the Purpose entries from your transactions file, you can be on your way to a spreadsheet. First, you create a table-style report format in the database. For the spreadsheet, you will want row labels to reflect the types of expenses and income, and you can get these from the category listings in the database. After these, you will have monthly expense projections. You'll have to enter this data yourself, but you can get it all from the database in the form of printed reports.

The first step with the database report is to delete all the unwanted data categories. You are no longer interested in the date of the transaction, its

Figure 1: The main financial file

expenses in the report. If, for example, you have records for May, June, and July, but you want to know only total expenses for June, you can make that stipulation as part of the record-selection rules—you can ask for a report of all the records, where Type is equal to expense and Date is after May 31 and before July 1.

You don't have this problem with the year-to-date tax deductions or year-to-date income reports, because you always want to include all related

Figure 2: This report shows total monthly expenses.

amount, the type of transaction (all types of transactions belong in the budget), or whether or not the transaction is tax-deductible, so you can delete these categories. Now, the problem is that although every category of income and expense shows up in the file, the file contains more than one record for many categories—there will be several entries for food, income, rent, and so on. For the spreadsheet, you want only one label for each category.

The simplest way to deal with this hodgepodge is to arrange each category alphabetically in the database report. This way, all the similar-purpose entries (in Cash, Paycheck, or Interest, for example) will appear next to each other, and finding and deleting them once the data has moved to the spreadsheet will be a simple matter (see figure 3 for an example).

With your report format set up so only the category data will print out, you save the report to the disk as a DIF file and then return to the AppleWorks

**PERSONAL**  
*AppleWorks*  
Now you can  
recycle your  
data instead of  
retyping it.

main menu. Then you create a spreadsheet from a DIF file and use your newly created DIF file as the source. When you name the new spreadsheet, your category data transfers to the first column in the spreadsheet. You'll probably have to widen the column with the spreadsheet's Layout com-

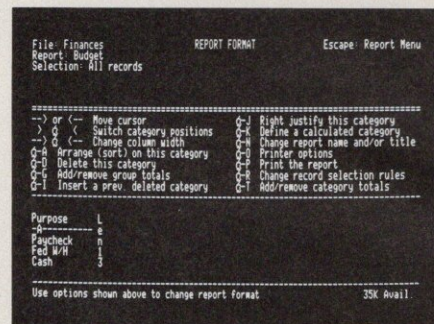

Figure 3: Grouping similar-purpose entries

mand to see all the data in every cell (see figure 4).

Now, you can simply duplicate category names. After this, you'll want to move certain categories around (putting expenses in one area and income

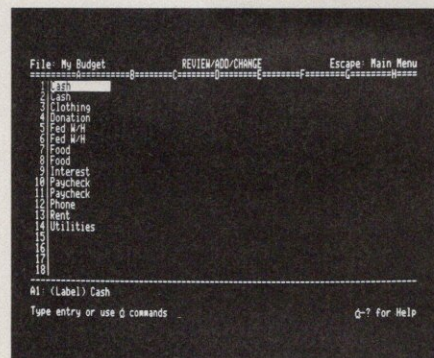

Figure 4: Spreadsheet with category data

in another, for example) so you can easily get subtotals of expenses and income later. You can also insert rows to contain the subtotals. Each month in the budget should get a column label to the right of the purpose label.

After you've entered the basic labels, you can add some other features, such as a section at the bottom of the worksheet to show the variance between income and expenses and a column at the far right to show average monthly expenses for each category. You can use @SUM formulas to calculate all of the subtotals and totals, and the AppleWorks @AVG function is the one to use to create the Averages column (see figure 5).

Now for the data. You want to know the monthly expenses in each category, for each month. Suppose you have only two months' worth of trans-

## TravelMaster Cases: Two Good For Your IIC.

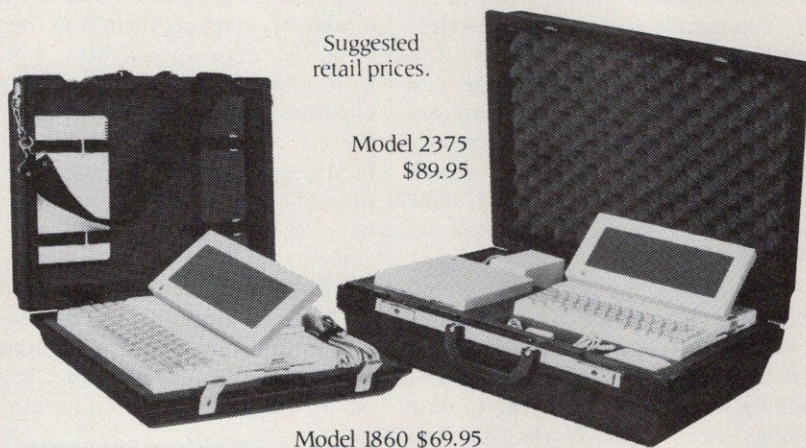

Suggested  
retail prices.

Model 2375  
\$89.95

Model 1860 \$69.95

The last thing you want to worry about is your new Apple IIc taking a lot of licks, whether it's by your side in the car, under the seat on the plane or just moving from class to class.

Enter TravelMaster, from Southern Case.

The double-wall polyethylene case that incorporates high density thick foam padding, a cushioning layer of trapped air for extra support and sleek locking latches that open when you want, not before.

And TravelMaster's two models, designed specifically for the Apple IIc, accommodate your entire system. The 1860 case comfortably nests your IIc keyboard, the new LCD flat screen, modem, power supply and all related cables. For a larger system, our 2375 model holds your additional disk drive and mouse unit, as well.

Call us toll-free today. Because now your new Apple IIc not only has it good, it has it two good.



CALL TOLL FREE  
1-800-334-0551  
in NC, call 919-821-0877

**Southern Case, Inc.**  
PO Box 28147  
Raleigh, NC 27611



Allow 2-4 weeks for delivery.

CIRCLE 120 ON READER SERVICE CARD

# NORTHEASTERN SOFTWARE

88 Ryders Lane, Stratford, Connecticut 06497

- Up to 50% off • New larger facilities
- School & corporate purchase orders accepted
- For items not listed please call
- We ship Federal Express — call for details

<b>Advanced Ideas</b>		<b>Dow Jones</b>		<b>Suspended</b>	28.00	<b>Penguin</b>		<b>Specials</b>	
Lucky's Magic Hat	25.00	Market Manager Plus	119.00	Witness	25.00	Graphics Magician	29.00	Copy II Mac	22.00
Dinosaurs Dig	25.00	Spreadsheet Link	60.00	Zork I	25.00	Pensate	24.00	Maxell Disks 3 1/2	34.00
<b>Advanced Logic Systems</b>		Straight Talk	48.00	Zork II	25.00	Quest	24.00	Memorex Disks 3 1/2	33.00
Mighty Mac	Call	<b>Electronic Arts</b>		Zork III	28.00	The Coveted Mirror	24.00	Smooth Talker	95.00
<b>American Training Int'l (ATI)</b>		Financial Cookbook	27.00	<b>Intelligent Statements</b>		Transylvania	24.00	Sony Disks 3 1/2	35.00
MacCoach (Intro. to the Mac)	45.00	Pinball Construction Set	27.00	Professional Blackjack	47.00	Xyphus	24.00	Tecmar Hard Disks	Call
<b>Ann Arbor Softworks</b>		EnterSet Quick Set	Call	Trivia Arcade	23.00	<b>Planitir MacType</b>	31.00		
Animation Tool Kit 1	30.00	<b>Essoft Enterprises</b>		<b>Intermatrix Chequebook</b>	46.00	<b>Professional Software</b>			
Animation Tool Kit 1 (Adv. Ver.)	Call	ColorPrint Software	Call	Kensington Microware LTD		Trivia Fever	24.00		
<b>Apple Computer</b>		ColorPrint Starter Kit	Call	Professional Type Fonts	60.00	<b>Protekt-It Software</b>			
Mac Project	Call	<b>Expertelligence Expertogo</b>	80.00	Layered Inc. Front Desk	89.00	Pro Copy	Call		
Mac Terminal	Call	<b>Forethought</b>		Living Video Text		<b>ProVue Development</b>			
<b>Apropos</b>		Factfinder	89.00	Think Tank - 128K	75.00	Overvue	174.00		
Financial Planning	64.00	Typing Intrigue	30.00	Think Tank - 512K	145.00	<b>Priority Software</b>			
Investment Planning	64.00	<b>General Computer Co.</b>		Lotus Jazz	Call	Forbidden Quest	27.00		
Tax Planner	34.00	Ground Zero	24.00	<b>Macadam Publishing</b>		Gateway	27.00		
<b>Artsci Magic File</b>	59.00	<b>Haba Systems</b>		Windoware Calendar	33.00	<b>Real Data Inc.</b>			
<b>Assimilations Process</b>		Haba Checkminder	Call	Windoware Phonebook	33.00	Commercial Real Estate Dev.	75.00		
Lock-It	20.00	Haba Com	Call	<b>Magnum</b>		General Financial Analysis	75.00		
Mac Memory Disk	20.00	Habadex	50.00	McPic I	30.50	Residential Real Estate	75.00		
Mac Spell Right	60.00	Haba Window Dialer	Call	McPic II	30.50	<b>Reston Publishing</b>			
Mac Tracks	20.00	<b>Harvard Associates</b>		The Slide Show	37.00	Construction Estimator	49.00		
<b>Axlon</b>		Desktoppers	30.00	<b>Mainstreet</b>		<b>Rio Grande Software</b>			
Art Portfolio	35.00	MacManager	31.00	Main Street Filer	114.00	Softmaker II	105.00		
Card Shoppe	35.00	<b>Hayden Software</b>		Main Street Writer		<b>Scarborough</b>			
Macmatch	31.00	Davinci Building Blocks	49.00	<b>Mainstay Macasm</b>	75.00	Make Millions	29.00		
Mouse Tracks	30.00	Davinci Commercial Interiors	118.00	<b>Manhattan Graphics</b>		Mastertype	29.00		
Typing Avalanche	36.00	Davinci Houses	30.00	Ready Set Go	Call	Run for the Money	30.50		
<b>Blue Chip</b>		Davinci Interiors	30.00	<b>Mark of the Unicorn</b>		<b>Sierra-OnLine Frogger</b>	24.50		
Baron	36.00	Davinci Landscapes	30.00	Mouse Stampede	23.00	<b>Simon &amp; Schuster</b>			
Millionaire	36.00	Ensemble	178.00	<b>Matrix Associates Images</b>	28.00	Typing Tutor III	31.00		
Tycoon	36.00	Hayden Base	92.00	<b>MegaHaus</b>		Sir Tech Wizardry	35.00		
<b>Boston Software</b>		Hayden Speller	47.00	Megafiler	114.00	<b>Softech Microsystems</b>			
MacPublisher	78.00	I Know It's Here Somewhere	28.00	Megaform	177.00	Advanced Dev. Tool Kit	105.00		
<b>Brainworks</b>		Master Pieces	24.00	MegaDesk	75.00	Fortran 77 Dev. Sys.	200.00		
Chipwits	30.00	Music Works	47.00	MegaMerge	74.00	Fortran 77 Lang. Compiler	165.00		
Thinkfast	24.00	Sargon III	30.00	<b>Micro Analyst Mac Zap</b>	49.00	Mac Advantage: UCSD Pascal	200.00		
<b>Brock Software</b>		Word Challenge	25.00	<b>Microsoft</b>		UCSD Pascal Dev. Sys.	84.00		
Keystroke Database	274.00	<b>Henderson Associates</b>		Business Pack	357.00	UCSD Pascal Lang. Compiler	100.00		
<b>Broderbund</b>		Real Poker	25.00	File	115.00	<b>Softstyle Epstart</b>	23.00		
Cyborg	25.00	<b>Hippopotamus Hippo-C</b>	117.00	Mac Basic Interpreter		<b>Softsync</b>			
Lode Runner	25.00	<b>Human Edge</b>		Microsoft Chart	74.00	Personal Accountant	55.00		
<b>Casady Company</b>		Communication Edge	115.00	Microsoft Multiplan	115.00	<b>Software Arts</b>			
Fluent Fonts	Call	Management Edge	145.00	Microsoft Word	115.00	TK Templates	35.00		
<b>CBS Murder by the Dozen</b>	28.00	Mind Prober	31.00	<b>Miles</b>		TKI Solver	145.00		
<b>Central Point Mac Tools</b>	22.00	Negotiation Edge	170.00	Mac Attack	29.00	<b>Software Publishing</b>			
<b>Continental/Arrays</b>		Sales Edge	145.00	Mac the Knife	23.00	PFS: File	70.00		
The Home Accountant	57.00	<b>Idealform MacLabeler</b>	36.00	Mac the Knife II	29.00	PFS: Report	70.00		
<b>Creative Solutions</b>		<b>Industrial Computations</b>		<b>Mirage Trivia</b>	29.00	PFS: File & Report	110.00		
MacForth Level 1	89.00	MacPuzzle	29.00	<b>Monogram</b>		<b>Softworks Limited</b>			
MacForth Level 2	139.00	<b>Infocom</b>		Dollars & Sense	82.00	Softworks C	275.00		
<b>Creighton Development, Inc.</b>		Cutthroats	25.00	Forecast	42.00	<b>Southeastern Software</b>			
Home Pak	24.00	Deadline	31.00	<b>NewSoft NewGammon</b>	Call	Mac Transfer	32.00		
MacOffice	24.00	Enchanter	25.00	<b>Odesta Helix</b>	240.00	<b>State of the Art</b>			
MacSpell+	60.00	Hitchhiker's Guide to the Galaxy	25.00	<b>Organizational Software</b>		Electric Checkbook	49.00		
<b>CSD, Inc. MacLion</b>	Call	Infidel	28.00	Omnis 2	164.00	Stoneware DB Master Mac	115.00		
<b>DataPak Software</b>		Planetfall	24.00	Omnis 3	215.00	<b>T/Maker</b>			
MacJack	27.00	Seastalker	25.00	<b>PCA Software MacSmith</b>	42.00	Click Art Personal Graphics	30.00		
MacPoker	27.00	Sorcereer	28.00	<b>Peachtree</b>		Click Art Publications	30.00		
MacSlots	48.00	Starcross	31.00	Back to Basics	215.00	Click Art Letters	30.00		
<b>Desktop Software 1st Base</b>	108.00	Suspect	28.00	GL/AR/AP	ea. 95.00	<b>Telos</b>			
						File Vision	115.00		
						File Vision (Int'l.)	115.00		
						File Vision (UK)	115.00		
						<b>Think Educational</b>			
						MacEdge	30.00		
						Mind Over Mac	30.00		
						<b>Videx</b>			
						MacCalendar	53.00		
						MacCheckers and Reversi	28.00		
						MacFun Pak (4 Games)	24.00		
						MacGammon & Cribbage	28.00		
						MacVegas	34.00		
						<b>Warner</b>			
						Desk Organizer Mac	61.00		

For Inquiries and Connecticut Orders Call (203) 375-3860

For Fast Delivery send cashier's check, certified check or money order. Personal and company check allow 3 weeks to clear. Shipping - Software (\$2.50 minimum), C.O.D. add an additional \$1.75. Shipping - Hardware (please call). Alaska, Hawaii, Canada, P.O. APO and FPO \$5.00 minimum. Foreign orders - \$15.00 minimum and 15% of all orders over \$100. Mastercard & Visa (include card # and expiration date). Connecticut residents add 7.5% sales tax. We ship same day for most orders. Prices subject to change without notice. School purchase orders accepted. All returns must have a return authorization number. Call 203-375-3860 to obtain one before returning goods for replacement.



Orders Only • Toll Free

7 Days/Wk 9 a.m. to 9 p.m. EST

1-800-382-2242

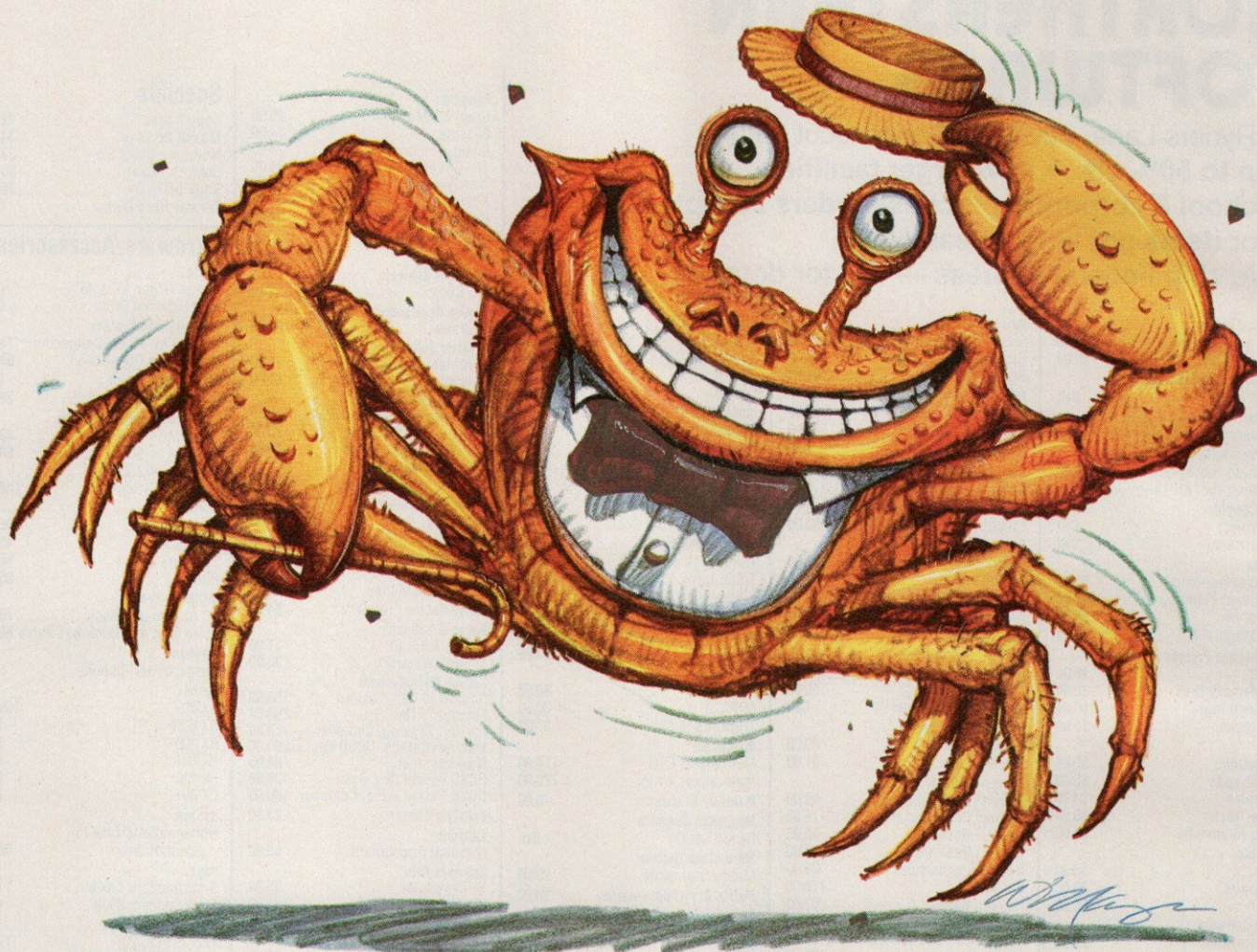

**Sometimes the best way to get ahead is to go sideways.**

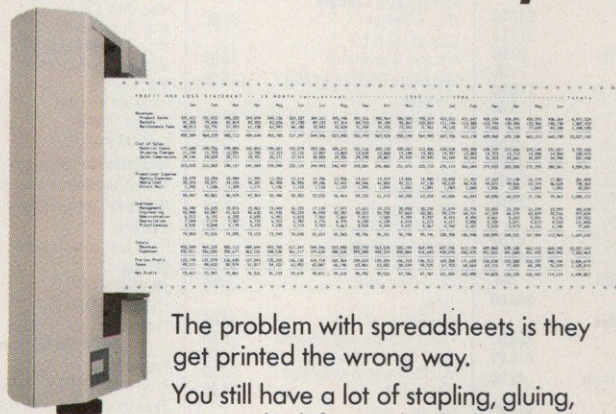

The problem with spreadsheets is they get printed the wrong way.

You still have a lot of stapling, gluing, or taping to look forward to before your printout is readable.

To really get ahead, go Sideways.™

Sideways is the clever software program that prints your spreadsheets—you guessed it—sideways. So your spreadsheet columns need never fall off the edge of your printer paper again.

With Sideways on your side, no spreadsheet you invent with Lotus 1-2-3,® Symphony,™ VisiCalc,® Multiplan,® or SuperCalc™ is too wide! And it's just as powerful an ally when you're creating far-into-the-future schedules and PERT charts. So for a presentable printout, get rid of that glue stick and scotch tape—put your best foot forward and go Sideways.

You can go Sideways today with an IBM® PC or an Apple® II, and over a dozen different printers, including Epson,® Okidata, IBM,® Apple,® C. Itoh and Mannesmann Tally. Ask for Sideways at your local ComputerLand,® Entre, or other computer store. Or mail a \$60 check to Funk Software, P.O. Box 1290, Cambridge, MA 02238. Or call 617-497-6339. MC/Visa accepted.

**SIDEWAYS™**  
SIDEWAYS PRINTS SPREADSHEETS SIDEWAYS.



action data in your database file. To get monthly totals for each expense or income category, you simply use the record-selection rules on the report-format screen to produce reports on individual categories.

For example, you can specify that the report contain records where Pur-

File: My Budget	REVIEW/ADD/CHANGE							Escape: Main Menu
Item	Jul	Aug	Sep	Oct	Nov	Dec	Aug	
1 Cash	\$188	\$188	\$188	\$188	\$188	\$188	\$188	
2 Clothing	\$25	\$25	\$25	\$25	\$25	\$25	\$25	
3 Donation	\$8	\$8	\$8	\$8	\$8	\$8	\$8	
4 Food	\$188	\$188	\$188	\$188	\$188	\$188	\$188	
5 Phone	\$35	\$35	\$35	\$35	\$35	\$35	\$35	
6 Rent	\$122	\$122	\$122	\$122	\$122	\$122	\$122	
7 Utilities	\$58	\$58	\$58	\$58	\$58	\$58	\$58	
8 Total Expen	\$668	\$668	\$668	\$665	\$665	\$655	\$665	
9 Paycheck	\$1,122	\$1,122	\$1,122	\$1,122	\$1,122	\$1,122	\$1,122	
10 Interest	\$8	\$8	\$8	\$8	\$8	\$8	\$8	
11 Total Inc	\$1,130	\$1,130	\$1,130	\$1,130	\$1,130	\$1,130	\$1,130	
12 Less Expen	\$668	\$668	\$668	\$665	\$665	\$655	\$665	
13 Variance	\$462	\$462	\$462	\$465	\$465	\$475	\$465	

Figure 5: A complete home-finance spreadsheet

pose is equal to Food, and Date is after May 31 and before July 1. These instructions give you all the food expenses for June. You can specify a category total in the Amount category before printing the report, thus getting a grand total of all food expenses.

Once you've set up this report format, you can go through each expense category by simply changing the category name in the record-selection rules. Instead of Food, you can specify Rent, Utilities, or whatever. You can quickly print each report to the screen and copy down the total expense for the month for later entry into the spreadsheet.

So, from this one file of basic financial transactions, you can develop four useful data tools that help you plan your income and expenses. At the end of the year, a few minutes will be all you need to gather all your tax-related data, and throughout the year you'll have a firm handle on what you're spending and why.

You can also expand this main financial file to include Name, Address, Account Number, and Balance categories. Such an arrangement lets you enter credit-card or installment-loan information. In that case, you can use the Amount category to record monthly installment payments, Type is still an expense, and Purpose contains the name of each credit card. Because the credit information is all in one place, you can get at it easily when you want to prepare a credit report for a loan application or quickly determine how much credit you currently have available.

AppleWorks can take a lot of the

# PERSONAL AppleWorks

## AppleWorks makes it easy to define and store specific reports.

headaches out of organizing personal information—financial and otherwise. You'll need to put in some initial effort to gather the data in the first place, but once you've set up a personal set of data tools, you can get the answers you need with a minimum of hassle. +

Charles Rubin's latest computer book, *AppleWorks*, will be published in July by Microsoft Press. He is also the author of *The Endless Apple* and writes features and reviews for various computer publications.

## SOFTWARE FOR ALL OF US from Core Concepts™

Financial-Productivity Series

FREE SHIPPING!

NEW!

### PROFIT PURSUIT™ 4 programs on 1 disk. ONLY \$34.95

- LEASE MASTER™:** Find lease payment amounts, pre-tax monthly and yearly yield, total yield. Compute with multiple advance payments and residual value. Print or display lease amortizations starting or stopping at any period.
- PRICING MASTER™:** Find the cost, selling price, mark-up, and margin. Recalculate by changing any entry. Print item name and data. A must for retailers & wholesalers!
- DEPRECIATION + :** Print or display Straight-Line, Declining Balance, Sum-of-the-Years-Digits depreciations. Plus, 3, 5, and 10 year ACRS for personal property, 15 & 18 year ACRS for real estate.
- APR!:** Find the Actual Percentage Rate of loans with prepaid points and fees. APR! will compute the monthly payment amount.

### WORK FORCE II™ 6 programs on 1 disk. ONLY \$34.95.

- THE LOAN ANALYZER:** Compute loan and mortgage amortizations, balloon payments, total interest paid, daily percentage rates, present value of capital leases, and periodic payment amounts. Find an unknown term or the amount which can be financed. Print or display amortizations starting or stopping at any period.
- THE LINE WRITER™:** A line-at-a-time correctable typewriter. Great for addressing envelopes and other small word processing jobs.
- THE BALANCING ACT™:** Checkbook balancing is made easy with this once a month checkbook balancing program. Menus allow entries to be added or changed. Group totals, amount of error, and all entries can be printed or displayed.
- THE CALCULATOR:** Turns your Apple into a four function printing calculator with memory and percent.
- THE SAVINGS ANALYZER:** Compute the future value of savings, IRA's, and investments in moments with The Savings Analyzer.
- THE WAGE ANALYZER:** Analyze your income by the hour, time & 1/2, weekly, bi-weekly, semi-monthly and annually. Calculate increases or decreases by amount or percent. Printout provides a great way to present pay raises to employees.

Greg Glau of InCider says: "Borrowing money is no problem with the loan analysis section to guide you. Work Force II is easy to understand and operate. It's an honest value..." June 1984

Compatible with the Apple IIc, IIe, II+, & II

Call Toll Free

ORDERS ONLY / 24 HOURS

1-800-221-9280

Ext. 979

ALL ORDERS  
SHIPPED  
IMMEDIATELY!

Apple is the trademark of  
Apple Computers Inc.

Since 1983

- Please send me PROFIT PURSUIT at \$34.95  
 Please send me WORK FORCE II at \$34.95  
 check or money order  VISA  MC  AE  COD (add \$4.00 for COD)  
 Arizona residents add 6% Sales Tax. Overseas add \$5.00

Card # \_\_\_\_\_

Signature \_\_\_\_\_ Valid From \_\_\_\_\_ to \_\_\_\_\_

Name \_\_\_\_\_ Phone \_\_\_\_\_

Address \_\_\_\_\_

City/State/Zip \_\_\_\_\_



Core Concepts  
P.O. Box 24157 Tempe, AZ 85282  
Product Information (602) 968-3756



DEALER INQUIRIES INVITED

CIRCLE 236 ON READER SERVICE CARD

Quiet and reliable,  
ink-jet printers  
produce high-quality  
black-and-white and color  
text and graphics.

# MEET THE inkjets

What accessories for your Apple computer are uncommonly quiet and sometimes colorful and use a high-tech squirt gun? Give up? The answer: ink-jet printers.

Ink-jet printers are the newest addition to the already large group of available dot-matrix printers. They come in models that print in black and white, and others that print also in color. All of them are remarkably quiet while operating and tend to be more reliable than other types of computers because of fewer moving parts. We'll be looking at three black-and-white ink-jet printers—the Siemens PT88 and PT89 and the Hewlett-Packard ThinkJet—and two color “inkjets”—the Diablo C150 and the Quadram QuadJet.

## **What's So Jet-Set about InkJets?**

The biggest attraction of ink-jet printers is the absence of noise. If you quickly tire of the screeching sound of most impact (or ribbon) dot-matrix printers, the ink-jet printer is a welcome alternative. Only laser printers can match or improve on the silence of an ink-jet printer, but at a much higher price. Another attraction of many (though not all) ink-jet printers is their small size and weight. Also, many ink-jet printers have ink cartridges that make changing them a neater operation than installing a new ribbon on most impact dot-matrix printers.

Some ink-jet printers offer more

text-formatting features than others, such as underlining, bold print, different character sizes, and so on. The printers can switch among these formatting modes with short escape sequences (you use the Escape key) without making you resort to bit-mapping to put a new character set in place. All of the printers we looked at provide escape sequences to adjust the margins and the horizontal and vertical tabs and offer additional character sets beyond the standard characters. If you're interested in using an additional character set with your Apple II (such as French or Spanish), be sure to check the users' manual before you buy any printer, since these sets vary.

Ink-jet printers boast of higher reliability due to fewer internal moving parts, but this boast may be offset by the danger of possible ink clogging or ink spills. Although with proper care these things may never happen, you have to remember certain dos and don'ts (depending on the printer) before leaving the printer off for extended periods of time or attempting to move it after it's been set up.

Color ink-jet printers usually offer more speed and brighter colors than do impact dot-matrix printers with color

ribbons. They do so because the ink-jet printers combine colors directly on the page without having to make multiple passes, unlike the color impact printers.

## **High-Tech Squirt Guns**

Ink-jet printers print by using a process called “drop on demand.” This process uses electrical signals to squeeze a diaphragm at one end of a chamber connected to an inkwell. The in-and-out motion of the diaphragm sucks tiny droplets of ink into the chamber and squirts them out through a nozzle onto the paper. The process is similar to what happens when you squeeze an oilcan. In the case of ink jets, however, the vibrating diaphragm sprays the ink out in precise dots to form the characters as the printhead zips across the carriage.

With a color ink-jet printer, you can print not only the four ink-jet colors themselves, but also combinations of these colors. The four ink-cartridge colors are usually black, yellow, cyan (blue), and magenta. The printer creates three secondary colors, such as violet, red, and green, by combining the primary colors at the same point on the paper. To achieve other shades, techniques such as alternating colors in small stripes are necessary to keep multicolor combinations from blurring.

Bleeding, or the blurring of images, can be a problem with ink-jet printers since the fibers in regular bond paper

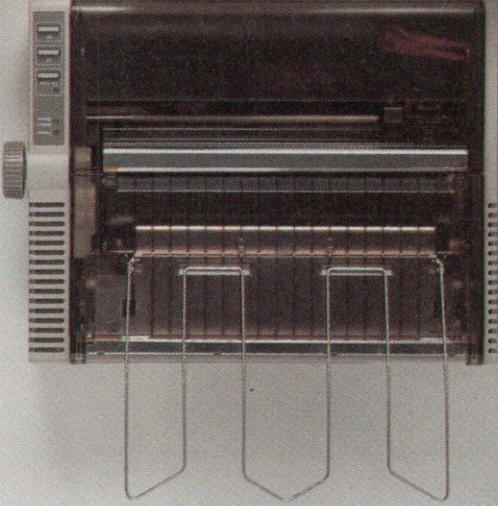
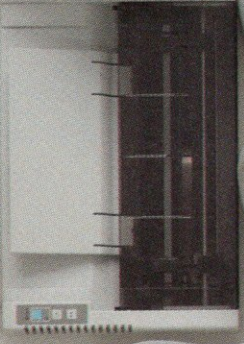
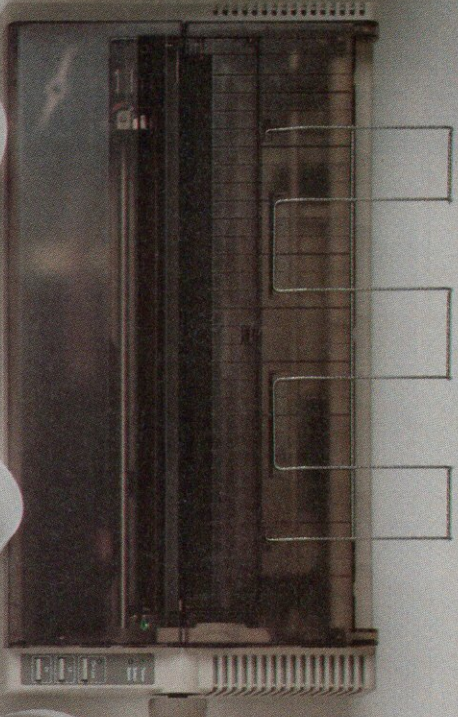
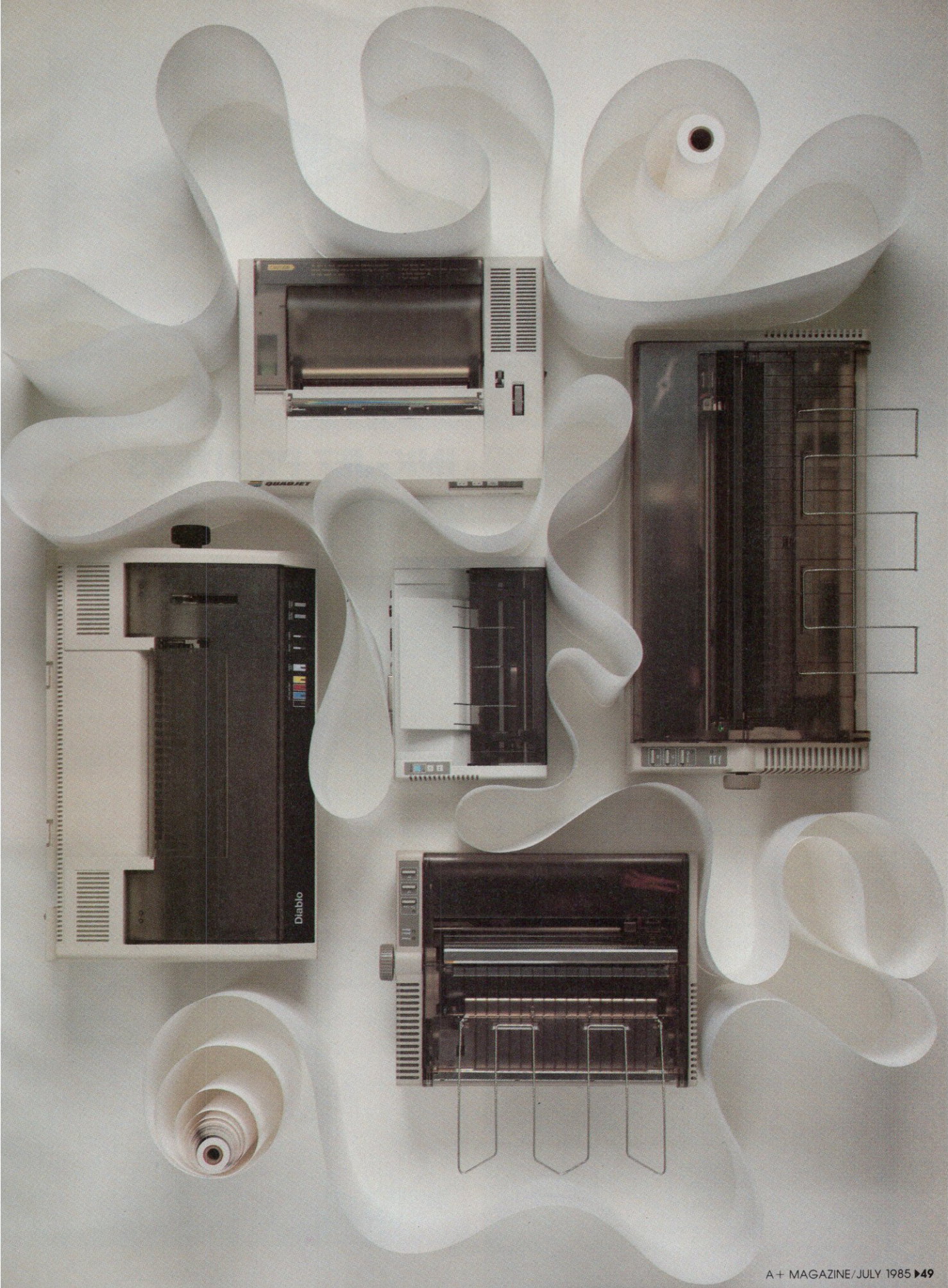



**DIABLO C150**



**QUADRAM QUADJET**



**HEWLETT-PACKARD THINKJET**

## INK-JET PRINTERS

MANUFACTURER	DIABLO	HEWLETT-PACKARD
MODEL	C150	ThinkJet
PRICE	\$1250	\$495
COLOR	Yes	No
SIZE (H x W x D)	6.1 x 20.9 x 13.7	3.5 x 11.5 x 8
WEIGHT (lbs.)	24.2	6.0
CHARACTERS PER SECOND (cps)	20	150
NOISE LEVEL (DBA)	<55	<50
BUFFER SIZE (characters)	4000	1024



**SIEMENS PT88**



**SIEMENS PT89**

easily absorb the ink. For this reason, you need to use special, coated paper with an ink-jet printer to achieve good print quality and color. (That's not to say that you won't be able to read text printed on regular bond or typing paper.) The special paper is relatively expensive, but it does come in rolls, fanfold, and single-sheet formats.

#### Setting Up for Evaluation

All of the printers we evaluated work with Centronics-type parallel interfaces, although some also offer serial RS-232 interface options. If you have an Apple IIc or III computer, make sure you get the RS-232 serial version of the printer, along with the appropriate printer cable.

If you're an Apple II, II Plus, or IIe owner, you may have to buy an additional circuit card to put in slot 1. If you're interested in graphics capabilities, you will want to buy a graphics card that is compatible with both the

#### Siemens PT88 and PT89

For a truly quiet and fast black-and-white printer, you should try the PT88 or the PT89. These sister printers are identical except for the width of their carriages, and they are the quietest for normal operation of all those we looked at. The driving motor within the machine makes a soft whining sound as the carriage scrolls and almost no noise as the printhead moves across the carriage. The driving motor is fast, too. It took the Siemens printers 3 minutes and 15 seconds to print out this article. The PT88 holds roll paper, fanfold paper up to 9.8 inches, and single sheets up to 8.5 inches wide; the PT89 holds fanfold paper or single sheets up to 15.7 inches wide.

Both the PT88 and the PT89 include four different character pitches, sized from as large as 5 characters per inch (cpi) to 17 cpi. Escape sequences also exist for superscript, subscript, and underlining. Superscripts and subscripts come in handy if you footnote, or if you write mathematical or chemistry formulas, and so on. In addition to the standard character set, there are six international character sets (a total of 78 additional characters) that you can call up via control codes.

The Siemens ink-jet printers leave something to be desired in print quality.

The dots that make up the characters are quite visible, giving them a grainy look that's similar to what you'd expect from most dot-matrix printers. Sometimes the printers seem to miss a pass over the paper, causing a blank horizontal hairline through the text letters. The Siemens printers allow you to print both text and graphics on the same line.

Hooking the Siemens PT88 or PT89 up to your Apple is almost a snap. Just make sure the printer's interface matches the port or card on your Apple. If your dealer helps you set up before you make the purchase, you may be able to avoid wading through the fairly technical users' manual—a task that requires strong determination.

#### Hewlett-Packard's ThinkJet

Most of the praise you've read about

## Confused About Data Base Programs?

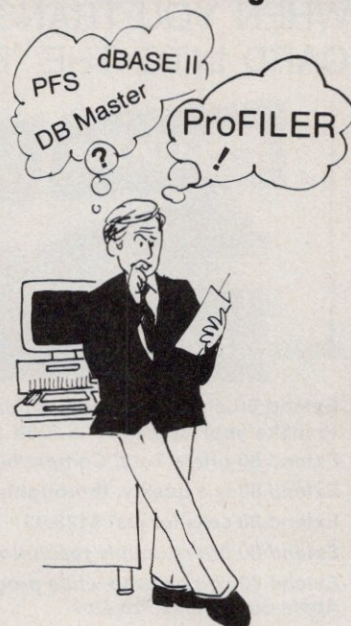

When you compare feature and price there is no confusion.

### ProFILER 2.0 is HERE!

The Data Manager for the Apple Computer with all the NEW features you've been waiting for.

8 times faster than DOS 3.3 - Twice as fast as ProFILER 1.0

FEATURE	ProFILER†	PFS File*
Multiple Forms per Disk	YES	NO
Maximum Records per File (65,000 w/ ProFILE Hard Disk)	1500+	1000
Report Generator Included	YES	NO
	FREE	(\$100)
Pro DOS Operating System	YES	NO
	FREE	
Full Screen Editor	YES	NO
Works on Apple II+, IIe, IIc, III, Franklin	YES	YES
Arrow Keys function OK	YES	NO
Multiple Index Files	YES	NO
Auto Catalog of Data Files - NEW	YES	NO
Variable Printer Initialization - NEW	YES	NO
Reports to Screen or Printer - NEW	YES	NO
Easy Word Processor Interface - NEW	YES	NO
Apple writer II® Mailmerge interfaces - NEW	YES	NO
Cost DataBase	\$89.95	\$90.00+
Report Generator	FREE	\$90.00+
<b>TOTAL COST</b>	<b>\$89.95</b>	<b>\$180.00+</b>

ALL THESE FEATURES FOR ONLY \$89.95

**PFS Conversion Utility Program**  
Converts PFS files easily to ProFILER format  
**\$39.95**

ProFILER available from selected dealers or directly from:

**PAI software**

19731 Providence Ln. • Box 1788 Huntington Bch, CA 92647  
(714) 963-2221 • (714) 548-5429

Terms: Send \$89.95 (plus \$3.00 for shipping)

CA residents add 6%)



Mastercard, VISA Check or money order  
\*Apple, Applewriter II and ProFILE are registered trademarks of Apple Co., Inc.  
†PFS is a registered trademark of Software Publishing Corp.

† ProFILER by Custom Computer Products

CIRCLE 150 ON READER SERVICE CARD

QUADRAM	SIEMENS	SIEMENS
QuadJet	PT88	PT89
\$895	\$745	\$895
No	No	No
4.3 × 15.8 × 11.6	5.5 × 15.4 × 11.6	5.7 × 23 × 12.4
12.3	15.4	22.0
40	150	150
<50	≤45	≤45
80	165 (expandable to 4K)	165 (expandable to 4K)

printer and the graphics software you wish to use. Macintosh users need a special cable and software in order to take full advantage of the Mac's graphics abilities.

#### Let Your Dealer Prove It

Printing text on any of the ink-jet printers was easy; the fun came when we tried some graphics software with each printer. One of them just stood there and beeped at us; another went berserk until we cut the power. If you're wise, you'll have your dealer prove to you that the printer you're interested in, your computer's interface, and the software you want to run are all compatible, before you make the purchase. Actually, letting dealers fiddle with the printer's DIP switches and scramble for interface cards and cables is one way of seeing if they know their stuff.

# \*APPLEWORKS SAYS

## "55K Available"

### WHEN YOU TRANSFORM YOUR 80 COLUMN CARD INTO THE "EXTENDED 64K VERSION"



ONE  
YEAR  
WARRANTY

*If you are not satisfied  
you may return within ten  
days for a Full Refund.  
(Shipping not included)*

- Extend 80 plugs into your standard 80 column card to make your Apple II/e\* a 128K system.
- Extend 80 offers Total Compatibility.
- Extend 80 is a quality, thoroughly tested product.
- Extend 80 sells for just \$129.95 +
- Extend 80 offers double resolution graphics capability.
- Extend 80 can be used while programming under Apple computer's Pro Dots.

\*Appleworks and Apple II/e are trademarks of Apple Computer, Inc.

+ Add \$3.00 for shipping (\$5.00 outside the U.S. - Payment in U.S. dollars only)

To order send check for \$129.95 +  Mastercard  Visa  Am. Express

CALL TOLL (FL residents add 5% sales tax)

FREE:

CARIBBEAN COMPUTER SALES, INC.

1-800-821-0208

221 EAST OSCEOLA - SUITE 210

(OUTSIDE FLORIDA)

STUART, FL 33494

(305) 287-3336

CIRCLE 149 ON READER SERVICE CARD

## New dimensions in Bible study.

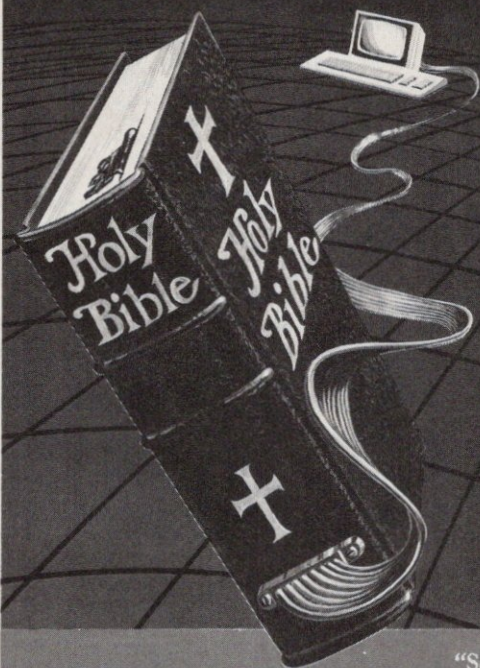

### THE WORD processor

The KJV or NIV Bible on disks. Search for any word or phrase, create personal indexes, print any verse. Build your own library of Scripture references. \$199.95

### THE GREEK transliterator

Start with any English word and find the original Greek, with definition and word roots. For any Greek word find every translation. Includes STRONG'S CONCORDANCE and the KJV New Testament. (Apple and IBM only.) \$199.95

Include \$3 postage/handling plus sales tax in Texas.

"Software for personal Bible study"

### Bible Research Systems

2013 Wells Branch Parkway, Suite 304  
Austin, Texas 78728  
(512) 251-7541

For Apple, IBM PC,  
Commodore 64, TRS80,  
Kaypro, CPM 2.2, MS-DOS.

CIRCLE 158 ON READER SERVICE CARD

Hewlett-Packard's ThinkJet is well deserved, especially considering the price of this printer, a black-and-white model that is small and packed with features. For instance, the ThinkJet provides four different character pitches, including one that HP calls Expanded-Compressed. What's more, you can do superscripts, subscripts, underlining, and bold characters. The bold text we printed, however, was only slightly different from the text in the Normal mode.

In addition to standard ASCII characters, the ThinkJet offers 78 characters in 6 international character sets and one alternate set of 128 characters called Roman Extension—quite an impressive variety.

The ThinkJet's size will probably surprise you. You might mistake it for one of those small thermal printers—it weighs only 6 pounds and is slightly larger than a shoe box. Its small size makes it especially convenient for use with the Apple IIc or Macintosh. Mac users will need the Jetstart software package from SoftStyle, which is a Macintosh printer driver for the ThinkJet.

The ThinkJet's print performance, however, is big for the price. Although the characters were a bit grainy, we had to pull out our magnifying glass to see the individual dots. For speed, the HP ThinkJet rated second in our contest, printing out this article in just under four minutes. The users' manual is also commendable—easy to understand, succinct, and the only manual we saw with an index.

The only disappointment that comes to mind is the difficulty we had in feeding paper into the ThinkJet. The carriage has a tractor-feeder but no knob for turning the carriage. With everything in such a small box, we found ourselves fumbling around a bit to get the paper in place and onto the feeders. The carriage is nothing more than two small wheels, each coated with a nonskid surface and each attached to one end of a metal rod. The absence of a standard typewriter-style carriage surprised us at first, but the ThinkJet's carriage poses no problems unless you have your heart set on using paper smaller than 8½ inches wide.

### Quadram QuadJet

The QuadJet is another amazingly compact printer, considering the features packed into its small size. This color ink-jet printer features two different print pitches, a bold-print mode, and seven basic colors (not counting

<b>Back Up Your Software</b>	
E. D. III (Best Nibble Copier!)	45.00
CIA Files (Best Disk Utilities!)	48.00
Copy II Plus - Central Point	21.00
Locksmith 5.0 - Omega	65.00
Nibbles Away III	49.00
Copy Master II 128k w/Gr. Dump	99.00
Wildcard II - Central Point	79.00
Replay II - Micro Analyst	79.00

<b>Macintosh</b>	
Jazz	Call
Mac Turbo Touch	89.00
Back To Basics General Ledger	89.00
Copy II Mac	22.00
Factfinder	89.00
Ensemble	175.00
Hayden Speller	47.00
Mac Spell Right	64.00
Mac Spell +	61.00
Microsoft Chart	74.00
Microsoft File	115.00
Microsoft Multitask	25.00
Microsoft Word	115.00
Microsoft Business Pack	349.00
ExperLogo	85.00
Dollars & Sense	81.00
Desk Organizer	62.00
TK Solver	145.00
Think Tank 128	27.00
BASF 3 1/2" Disks (5)	16.50
Maxell 3 1/2" Disks (10)	28.00
Verbatim 3 1/2" Disks (10)	28.00

<b>Entertainment</b>	
Adventure Construction Set	34.00
7 Cities of Gold	27.00
Murder on the Zinderneuf	25.00
Archon II or One-On-One	27.00
Pinball Construction Set	25.00
Gato	29.00
Ghost Busters of Pitfall II	27.00
Tracer Sanction or Mind Shadow	27.00
Miner 2049'er or The Heist	24.00
Wizardry	30.00
Knight of Diamonds	21.00
Legacy of Lyllygarn	24.00
Return of Werda	24.00
Rescue Raiders	22.00
Wiziprint	16.00
Super Zaxxon and Quest 3 Deep	24.00
The Quest or Ring Quest	21.00
Expedition Amazon, or Xyphus	21.00
Sword of Kadash	21.00
Below The Root	20.00
Swiss Family Robinson	20.00
Millionaire, Tycoon, or Barron	30.00
Solo Flight or Cargo	22.00
Amazon or Dragon World	25.00
Fahrenheit 451 or Shadow Keep	25.00
Flight Simulator II	32.00
Championship Lode Runner	22.00
Choplifter or Karateka	22.00
Pole Position or Zaxxon	20.00
Bruce Lee, Conan, or Mr. Do	24.00
Spy Hunter, Star Trek, or Tapper	27.00
Murder By The Dozen or Felony	25.00
Kings Quest	30.00
Beyond Castle Wolfenstein	21.00
Ultima III: Exodius	31.00
Sargon III	31.00
Cuthroths, or Sealstalker	24.00
Hitchhiker's Guide to The Galaxy	24.00
Deadline, or Starcross	30.00
Witness, Planetfall, or Enchanter	24.00
Infidel or Sorcerer	27.00
Zork II, Zork III, or Suspect	27.00
Zork I	24.00
Operation Market Garden	35.00
Objective Kursk or Phantasie	24.00
War in Russia	48.00
50 Mission Crush or BroadSides	24.00
Grupptgruppe or Reforger 88	36.00
Imperium Galactum	24.00
Germany 1985 or Car Wars	36.00
Baltic 85 or Gemstone Warrior	21.00
Geopolitique 1990 or Rails West	24.00
North Atlantic '86	36.00
Battle For Normandy	24.00

<b>Hobby</b>	
Apple Mechanic	17.00
Beagle Basic	20.00
Beagle G.P.L.E.	29.00
Beagle Graphics	33.00
D-Code	23.00
Disk Quick	14.00
Dos Bos	14.00
Double Take	20.00
Fat Cat	20.00
Flex Text	17.00
Frame Up	17.00
I.O. Silver	17.00
Pronto Dos	17.00
Silicon Satad	14.00
Triple Dump	23.00
Typefaces	11.00
Utility City	17.00
Bag of Tricks	25.00
Applesoft Compiler (Microsoft)	109.00
Einstein Compiler	85.00
Compiler Plus (Hayden)	37.00
Lisa V2.6	54.00
Merlin Pro	62.00
Merlin Assembler	37.00
Merlin Combo Pack	66.00
Visible Computer #502	36.00
The Graphics Magician	36.00
New Complete Graphics Sys.	48.00
Dazzle Draw	37.00
Pix-it	30.00
Take 1	36.00
Blasting Paddles	30.00
Zoom Graphics	31.00
Sideways	36.00
Fontrix	44.00
Font Paks 1-11 ea.	12.00
Printographer	24.00

<b>Blank Media</b>	
Elephant SS/DD (10)	12.50
Maxell SS/DD	16.95
Verbatim SS/DD (10)	16.95
BASF SS/DD (10)	14.95
Memorex SS/DD (10)	14.95
3M SS/DD (10)	17.95
Dysan SS/DD (10)	22.95

# PROGRAMS Plus

Visit Our New Showroom: Exit 32 off I-95

Stationhouse Square, 2505 Main Street • Stratford, Connecticut 06497

Corporate and School Purchase Orders Accepted

Mon.-Fri. 9 a.m. to 11 p.m. - Sat. 10 a.m. to 11 p.m.

ORDERS ONLY 1-800-832-3201

TOLL FREE

Inquiries & Conn. residents call (203) 378-3662 or 378-8293

Up to 50% off retail

MACINTOSH COMPUTERS ..... Call  
 APPLE //c, //e COMPUTERS ..... Call  
 LOWEST PRICES ON EPSON PRINTERS ..... Call

<b>Business</b>		Our Price		Our Price	
APPLE		Management Edge	149.00	Graphics Department	78.00
Access // (//e, //c)	59.00	Minid Prober	31.00	Report Card	37.00
Apple Works	199.00	Sales Edge	149.00	The Sensible Speller	72.00
Apple Writer // (//e, //c)	79.00	<b>KENSINGTON MICROWARE</b>		SIERRA ON-LINE	131.00
QUICKTIE // (//e, //c)	79.00	Format II Enhanced	90.00	The General Manager II	78.00
<b>APPLIED SOFTWARE TECHNOLOGY</b>				The Screen Writer //e	78.00
Versafarm	55.00	<b>LIVING VIDEOTEXT</b>		SILICON VALLEY	85.00
<b>ARTSICI</b>				List Handler (II+, //e, //c)	47.00
MegaCalc	94.00	MegaHAUS	97.00	The Handlers (II+, //e, //c)	103.00
Magi Office System	185.00	MegaSpell	37.00	Word Handler II (II+, //e, //c)	47.00
Magi Window II	94.00	MegaWorks	77.00	<b>SOFTWARE ARTS</b>	
<b>ASHTON TATE</b>				TKI Solver	179.00
dBase II w/Softcard	349.00	MICROPRO	64.00	The VisiCalc Package	114.00
Calstar	49.00	Calstar	49.00	<b>SOFTWARE PUBLISHING</b>	
Infostar w/Z-Card	120.00	Wordstar w/Z-Card	169.00	PSF: File	72.00
Wordstar w/Z-Card	228.00	Wordstar Pro w/Z-Card	228.00	PSF: Graph	72.00
<b>CONTINENTAL SOFTWARE</b>				PSF: Report	72.00
G/L, A/R, A/P, Payroll ea.	144.00	<b>MICROSOFI</b>		PSF: Write // (//e, //c)	72.00
Home Cataloger	31.00	Learning To Read w/Base II	329.00	PSF: Proof // (//e, //c)	43.00
<b>HAYDEN SOFTWARE</b>				PSF: Access // (//e, //c)	43.00
Writer V2.2	95.00	Multiplan (Apple Dos Version)	59.00	<b>SORCIM/US</b>	
The Writer	35.00	<b>ORGANIZATIONAL WOFTWARE</b>		SuperCalc 3a	119.00
<b>HUMAN EDGE SOFTWARE</b>				STATE OF THE ART	59.00
Communications Edge	119.00	Omnis 2	199.00	Electric Checkbook	59.00
		Omnis 3	339.00	<b>STONEWARE</b>	
		<b>PEACHTREE</b>		DB Master Business Team	219.00
		Back To Basics Accounting	125.00	DB Master Business Writer	98.00
		<b>PRACTICORP</b>		DB Master Version Four Plus	185.00
		Practical II	35.00	DB Master (Corvus)	249.00
		<b>QUARK</b>		<b>VISICORP</b>	
		Word Juggler & Lexicheck	118.00	Flashcalc II, //e, //c	62.00
		<b>SENSIBLE SOFTWARE</b>		VisiSchedule	92.00
		Bookends	72.00	<b>SCHOLASTIC WIZWARE</b>	
		<b>EDU-WARE/PEACHTREE</b>		Agent U.S.A. or Turtle Tracks	24.00
		Algebra 1, 2, 3, or 4	22.50	Operation: Frog or Logic Bldrs.	24.00
		Algebra 5 or 6	27.50	Robo Robot or Kids at Work	19.00
		Compu-Read	17.00	<b>SIMON &amp; SCHUSTER</b>	
		Compu-Math: Arithmetic Skills	29.00	Discover your Baby-Birth to 2	49.00
		Hands-on BASIC Programming	32.00	JK Lasser Money Manager	62.00
		Introduction to Counting	25.00	<b>SPINNAKER</b>	
		Learning To Read 1, 2, 3, or 4	25.00	Adventure Creator or Trains	27.00
		PSAT Word Attack Skills	18.00	Aerobics	24.00
		SAT Word Attack Skills	18.00	Counting Parade	21.00
		Spelling Bee w/Reading Primer	23.00	Delta Drawing	31.00
		Writing Skills 1, 2, 3 or 4	25.00	File & Report or Spreadsheets	42.00
		<b>EINSTEIN CORPORATION</b>		Fraction Fever or Sum Ducks	19.00
		Einstein Memory Trainer	55.00	Grandma's House	19.00
		<b>HARCOURT, BRACE</b>		In Search of	25.00
		Computer SAT	47.00	Kidwriter or Kindercomp	19.00
		<b>IMAGIC</b>		Snooper Troops 1 or 2	27.00
		Crime & Punishment	25.00	Treasure Island or Wizard of Oz	19.00
		Krell	22.50	Word Processor	42.00
		Adventure in Flesh	39.00	<b>SPRINGBOARD</b>	
		Krell Logo	65.00	Early Games or Music Maestro	21.00
		Krell SAT - Gold	225.00	Fraction Factory or Make a Match	19.00
		<b>LEARNING COMPANY</b>		Rainbow Painter or Puzzle Master	21.00
		Addition Magician	21.00	<b>SUNBURST</b>	
		Bumble Plot	24.00	Challenge Math	30.00
		Gerrude's Puzzles	18.00	Teasers by Tobbs	30.00
		Juggler's Rainbow	22.00	The Factory	30.00
		Magi Spell	24.00	The Incredible Laboratory	30.00
		Reader Rabbit	30.00	<b>TERRAPIN</b>	
		Robot Odyssey I	30.00	Terrapin Logo	60.00
		Rocky's Boots	30.00	<b>XEROX</b>	
		Word Spinner	21.00	Chivalry	32.00
		<b>SCARBOROUGH SYSTEMS</b>		Explor g Tables & Graphs 1 or 2	23.00
		Masterytype's Writing Wizard	49.00	Pic. Builder	24.00
		Build A Book About You	26.00	Stickybear Series (ea.)	24.00
		Orig. Boston Computer Diet.	52.00	<b>TG Select-A-Port</b>	
		<b>Accessories</b>		Apple Mouse //e	125.00
ALS Z-Engine 2.2	149.00	Microsoft Premium Softcard //e	259.00	Apple Super Serial Card	85.00
Microsoft Softcard II	239.00	Microsoft Softcard I	115.00	Serial Interface Card	115.00
Extend 80 (Carib. Computer)	195.00	MCT Speed Demon	199.00	Serial Grappler Plus	80.00
NCT Speed Ram	199.00	Neptune 80 Col. 64K Card	185.00	Pkaso-U Interface	119.00
Neptune 80 Col. 64K Card	185.00	Accelerator //e	239.00	Grappler +	79.00
Accelerator //e	239.00	Video Videoterm w/SS Inv.	175.00	Buffered Grappler +	145.00
Video Videoterm w/SS Inv.	175.00	Corvus Hard Disks	65.00	Printing (Spies Labs)	125.00
Videx Ultratarm	229.00	Mockingboard C Board	129.00	Finger Print Plus	99.00
Videx Ultratarm	229.00	Mockingboard D Board // (//c)	134.00	Print-It	135.00
Corvus Hard Disks	65.00	Echo II //c	95.00	Thunderclock +	109.00
Mockingboard A Board	129.00	The Cricket (//c)	115.00	Digital Paintbrush System	175.00
Mockingboard C Board	129.00	Hayes Mach II Joystick	29.00	Muppet Learning Keys	44.00
Mockingboard D Board // (//c)	134.00	Hayes Mach III Joystick	34.00	Koala Pad	75.00
Echo II //c	95.00	Kraft Joystick	32.00	Trackhouse Key Pad	85.00

<b>Accessories</b>		Our Price		Our Price	
ALS Cards	Call	ALS Z-Engine 2.2	149.00	TG Select-A-Port	26.00
Applied Engineering Cards	Call	Microsoft Premium Softcard //e	259.00	Apple Mouse //e	125.00
Kensington System Saver	64.00	Microsoft Softcard II	239.00	Apple Super Serial Card	85.00
Cool + Time	69.00	Extend 80 (Carib. Computer)	195.00	Serial Interface Card	115.00
Hayes 300 Baud Smartmodem //c	159.00	NCT Speed Ram	199.00	Serial Grappler Plus	80.00
Hayes 300 Baud Smartmodem //e	135.00	Neptune 80 Col. 64K Card	185.00	Pkaso-U Interface	119.00
Hayes 1200 Baud Smartmodem	389.00	Accelerator //e	239.00	Grappler +	79.00
Novation Apple Cat II	192.00	Video Videoterm w/SS Inv.	175.00	Buffered Grappler +	145.00
Novation 212 Apple Cat II	369.00	Corvus Hard Disks	65.00	Printing (Spies Labs)	125.00
Pro Modem 1200A (External)	Call	Mockingboard C Board	129.00	Finger Print Plus	99.00
Pro Modem 1200A (Internal)	Call	Mockingboard D Board // (//c)	134.00	Print-It	135.00
Popcom X-100 (1200 Baud)	Call	Echo II //c	95.00	Thunderclock +	109.00
ERA 2 by Microcom	345.00	The Cricket (//c)	115.00	Digital Paintbrush System	175.00
Zoom /Modem //e	129.00	Hayes Mach II Joystick	29.00	Muppet Learning Keys	44.00
Zoom /Modem //e Plus	159.00	Hayes Mach III Joystick	34.00	Koala Pad	75.00
Apricorn 16K Ramcard	68.00	Kraft Joystick	32.00	Trackhouse Key Pad	85.00

## CIRCLE 299 ON READER SERVICE CARD

For fast delivery send cashier's check, certified check or money order. Personal and checks allow 3 weeks to clear. Shipping - Software (\$2.50 min.) C.O.D. add an additional \$1.90. Shipping - Hardware (please call). Alaska, Hawaii, Canada, P.O. APO and FPO \$5.00 min. Foreign orders - \$15.00 min. and 15% of all orders over \$100. Mastercard & Visa (Include card # and expiration date). Connecticut residents add 7.5% sales tax. We ship same day for most orders. PRICES SUBJECT TO CHANGE WITHOUT NOTICE. All returns must have a return authorization number. Call 203-378-3662 to obtain one before returning goods for replacement. NOT RESPONSIBLE FOR TYPOGRAPHICAL ERRORS.

Note: All products are new and include factory warranty, therefore ALL sales are final. Defective hardware or software will be replaced by the same item only. We do not guaranty compatibility. Products purchased in error will not be exchanged or replaced.

Advertisement prepared May 1, 1985



<b>Printers</b>		Our Price
APPLE		
ImageWriter	495.00	
ImageWriter (Wide Carriage)	565.00	
Scripte Printer	249.00	
BROTHER		
HR-15XL	369.00	
HR-35	819.00	
CITIZEN		
MSP-10 (160 cps)	299.00	
MSP-15 (160 cps)	445.00	
MSP-20 (200 cps)	445.00	
MSP-25 (200 cps)	589.00	
C. ITOH		
ProWriter 8510 AP	295.00	
ProWriter 1550 AP	445.00	
ProWriter 8510 AP Plus	329.00	
ProWriter 1550 AP Plus		

MAJOR  
CREDIT  
CARDS  
ACCEPTED



OUR  
AD  
NO.  
1019-7

NO SALES TAX COLLECTED (N.J. Add 6%)

**COMPLETE READY-TO-RUN  
SYSTEM NOW ONLY \$1,777**

**DELUXE APPLE IIe PACKAGE**

- Apple IIe (128K)
- Two Disk II Drives by Apple
- Apple Drive Controller w/Pro Dos
- Extended 80 Column Card
- Grappler + Printer Card & Cable
- Epson LX-80 Printer (100 C.P.S.)
- Pkg. of Paper (500 Shts.)
- Zenith Green or Amber Monitor
- Extra Printer Ribbon
- System Dust Cover
- Deluxe Table Top Printer Stand
- Printer Dust Cover
- Box of 10 Diskettes



List \$2,389  
CDA \$1,777

- \* INCLUDES PRINTER
- \* TWO DISK DRIVES!
- \* YOUR CHOICE AMBER OR GREEN MONITOR
- \* 128K MEMORY

**EPSON SPECTRUM LX-80 PKG**

**Includes:**

- LX-80 100 CPS Printer
- Printer Card & Cable
- Deluxe Printer Stand
- Extra Printer Ribbon
- Case of Computer Paper (1800 Sheets)
- Printer Dust Cover

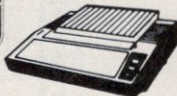

LX-80 FOR II/IIe  
DELUXE  
PRINTER PACKAGE

\* INCLUDES NEAR  
LETTER QUALITY MODE!

LIST \$579  
(IIC Version \$329)

**NOW ONLY \$349**

**EPSON FX-80 PRINTER**

**INCLUDES:**

- FX-80 + 160 CPS Printer
- Buffered Grappler + (16K) Interface w/Cable
- Deluxe Printer Stand
- Extra Printer Ribbon
- Case of Computer Paper (1800 Sheets)
- \*Epson-Apple Connection a detailed book on how to use the Epson with the Apple.



FX-80 + FOR II/IIe  
DELUXE PACKAGE

LIST \$889

**NOW ONLY \$569**  
(IIC Version \$549)

**APPLE ACCESSORIES**

ALS Smartterm II	\$179	\$129
ALS Z-Engine	199	149
Apple Mouse IIc	99	83
Apple Mouse IIe	149	132
Applied Eng. Z-80 IIC	159	119
Appl. Eng. RAM Works 128K	249	169
Appl. Eng. RAM Works 256K	399	279
Micro Sci Ext. 80 Col.	159	99
Microsoft Prem. Sftcrd.	395	299
Microsoft Sftcrd II	450	319
Titan Accelerator IIc	319	219
Video 7 Slot 7 RGB	159	109
Video 7 RGB Ext. 80 Col. Co.	269	179
Video 7 RGB for IIC	219	159

**APPLE DRIVES**

Apple IIC Add-On	329	279
Apple Disk II	329	269
Micro Sci A-2	299	199
Micro Sci 1/2 Hgt IIC	299	199
Micro Sci 1/2 Hgt	299	199
Rana Elite 1/2 Hgt	329	209
Rana Elite 1/2 Hgt IIC	339	219
Quark 10 Meg HrdDrv	1999	1495

**PRINTERS**

Apple Imagewriter	\$595	\$479
Brother HR-15	499	369
Brother HR-35	1245	829
Epson (All Models)	CALL	CALL
Juki 6000	299	239
Okidata (All Models)	CALL	CALL

**IF YOU DON'T  
SEE IT.....**

**MONITORS**

Amdek Color 300	\$339	\$259
Amdek Color 600	599	399
Zenith Green Phosphur	149	89
Zenith Amber Phosphur	159	89

**INQUIRE  
ABOUT IT!**

**MODEMS**

Hayes Micromodem IIC	339	219
Hayes Micromodem IIC	339	239
Hayes 2400 Smtmrdm	899	649
Novation Apple Cat II	319	219
Novation Apple Cat 212	595	429
Prometheus 1200 A	449	319
Prometheus External	449	339
Prometheus 1200	449	339
Mac Pac	449	339

**BUY DIRECT BY MAIL OR PHONE**

ORDERS ONLY 800-526-5313

Inquiries and in N.J. 201-728-8080

Information on your order 201-728-8082

ORDERING INFORMATION AND TERMS: Mail to  
COMPUTER DISCOUNT OF AMERICA

31 Marshall Hill Road, West Milford, N.J. 07480

Include address and phone number. Shipping, handling and insurance are additional add 2% UPS Ground (\$3.50 minimum), UPS Blue 6% (\$5.00 minimum) NO C.O.D. Cashiers checks, moneyorders, and credit cards ship immediately. Personal and company checks allow 15 days.  
ORDER 9 AM - 6 PM EST Monday - Friday • Saturday 10-4

white). Quadram's QuadJet is one of a number of ink-jet printers on the market today that are based on the Canon ink-jet engine. The QuadJet's four ink jets contain black, magenta, yellow, and cyan (blue) ink, and three other basic colors are easily available. Although Quadram calls these three secondary colors green, blue, and red, we felt they looked closer to green, purple, and orange. Still more colors are possible with alternate colors that print side by side.

Print quality on the QuadJet is a bit on the grainy side, with bold characters looking smoother than normal characters. Characters with curves in them (such as r or g) look slightly more jagged. Although the colors are nice on specially coated paper, they could stand to be somewhat brighter. Unfortunately, the QuadJet does an automatic line feed with each carriage return, which makes it difficult to print both text and graphics on the same line. Also, it is one of the slower printers, with a printing time of 12 minutes for this article.

The QuadJet can use either roll or single-sheet paper (no tractor-feeding is available). We found it easy to install the printer and to change paper and ink cartridges. Like battery packs, the two ink cartridges (one for black and one for colors) plug in behind a concealed

**We found it easy to install the QuadJet and to change paper and ink cartridges.**

cover in front. A concise and very readable users' manual is one of the reasons we experienced no problems.

Even though you can use any Centronics-compatible parallel port with the QuadJet for the Text mode, a graphics port or card simplifies the commands necessary to take advantage of the printer's graphics features. Quadram offers such a card for the Apple II, II Plus, and IIe called APIC/CG (Apple Parallel Interface Card with Color Graphics option).

**Diablo C150**

The print quality of Diablo's C150 color ink-jet printer is commendable. The near-letter-quality print is possibly the biggest attraction of the C150. The choice of seven colors (eight, counting white) doesn't hurt either. Weighing in as a heavyweight, compared to the other printers in this review, the C150 struck us as more of a business printer.

**INTRODUCING:**

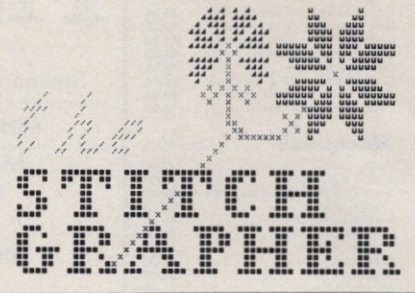

**NOW IT IS POSSIBLE**

to design your own counted cross stitch and other needlecraft charts using the latest innovative computer technology.

This user friendly program allows you to design projects as large as 240 x 400 stitches with up to 30 symbols and gives you the flexibility to move, copy, mirror image, rotate, erase, save and re-use previous designs.

Utilizing the **APPLE II** series microcomputers, "the **STITCH GRAPHER**" is compatible with most dot matrix printers supporting graphics.

Disk plus informative 75 page manual -**\$89.95.**

Dealer inquiries welcome. For additional information contact

**COMPUCRAFTS**

RFD 2 Box 216, Lincoln, MA 01773  
(617) 259-0409

CIRCLE 157 ON READER SERVICE CARD

**Tired of Paying High Prices . . .  
CHECK THESE PRODUCTS  
FOR THE APPLE!**

**New Software**

Prime Factor BASIC 3.0 . . . . . \$49.95  
(500 Digit Precision Math Package)  
Write for Free Flyer

**Monthly Special!**

Conquering Worlds . . . . . 9.95

**Software from Datamost**

Ankh	16.95
Aztec	16.95
Earthly Delights	16.95
Mabel's Mansion	16.95
Mr. Robot and his Robot Factory	16.95
Mychess II	24.95
Wiz Plus	29.95

**Books from Datamost**

The Apple Almanac	18.95
Apple Thesaurus	27.95
Using 6502 Assembly Language	16.95
Shortcut through Adventureland	16.95
Volumes I & II	two for 16.95

**Software/Book Combo's**

Games Apples Play	19.95
Designing Apple Games with Pizazz	24.95
p-Source	49.95

Send check or Money order to:

**INEXSOFT**

"Inexpensive Software & Books . . .  
Our name and our fame"

21115 Devonshire, Suite #401B  
Chatsworth, CA 91311  
(818) 882-1686

We pay the postage. CA residents add 6.5% sales tax. Most Datamost products available. Software pre-tested on request.

CIRCLE 168 ON READER SERVICE CARD

CIRCLE 292 ON READER SERVICE CARD



# SoftCard II<sup>™</sup> squeezes the most juice out of your Apple.

Microsoft<sup>®</sup> SoftCard II is the latest high-performance CP/M<sup>®</sup> board that really juices the Apple<sup>®</sup> II, IIe and II+.

### Hard facts on SoftCard.

The new SoftCard has a high speed (6MHz) Z-80 that runs CP/M programs up to three times faster than lesser boards. Plus 64K memory. And if that wasn't enough, we also support the Apple Profile hard disk.

Microsoft BASIC is included so it's compatible with more Apple CP/M software than any other board on the market. Thousands of the juiciest business programs including dBaseII<sup>™</sup>, WordStar<sup>®</sup> and sophisticated Microsoft languages

like FORTRAN-80, COBOL-80 and BASIC Compiler.

Juicing up the performance of computers is nothing new for us. We invented the SoftCard and wrote Applesoft for the Apple II.

**MICROSOFT**<sup>®</sup>  
The High Performance Software<sup>®</sup> In fact, our BASIC is the language spoken by nine out of ten microcomputers worldwide.

Get the Apple juicer from Washington. Call (800) 426-9400. In Washington State, Alaska, Hawaii and Canada, call (206) 828-8088 and ask for the name of your nearest Microsoft dealer.

Microsoft is a registered trademark and SoftCard and The High Performance Software are trademarks of Microsoft Corporation. Apple is a registered trademark of Apple Computer, Inc. dBase II is a trademark of Ashton-Tate. WordStar is a registered trademark of MicroPro. CP/M is a registered trademark of Digital Research, Inc.

# Imagewriter™ Owners

Congratulations, you own the professional-quality printer good enough for Apple™ to call their own. It is a printer whose software support is unrivaled. Vilberg Brothers Computing, Inc. has produced software to improve your Imagewriter's image. It includes 24 character fonts and the software to download them to your Imagewriter or Apple DMP™. These characters, since they are downloaded, can be used by ANY Apple II program --- from AppleWorks™ to Visicalc™. And they don't slow down printing speed!!!

**Match your characters to your task.** Use Cyber for program listings, Typewriter for formal papers, and Script for personal notes. Use Bold to get attention, Super/Sub-script and Greek for scientific manuscripts, and Fat Face for notes to your friends. If our 24 character sets do not contain the image you need then convert character sets from Applesoft Tool Kit™, Beagle Brothers, Higher Text II™ or Penguin's Fonts using the Utilities. Still need more character sets? Then use the Utilities' font editor to create those characters you need.

### Want to know more?

Read the review in *Softalk* (Feb 84). They called it "excellent" and described one of our Imagewriter fonts as "near letter quality". *Creative Computing* (April 84) thought so highly of the DMP Utilities they called them "a necessity". Find out for yourself. Circle the reader's service card and we'll send you an actual print sample. Then you can see the many images your Imagewriter can convey.

**Vilberg Brothers Computing, Inc.**  
PO Box 4576, Madison, WI 53711-4576  
(608) 274-6433

DMP Utilities costs \$50. (WI res add \$2.50 sales tax)  
Apple, AppleWorks, Imagewriter, Applesoft Toolkit, and Apple DMP are trademarks of Apple Computer, Inc.

Higher Text II is a trademark of Synergistic Software.  
Visicalc is a trademark of Visi-corp.

CIRCLE 244 ON READER SERVICE CARD

## FREE? DISKETTES

**SAVE MONEY!** Apple II series users can use the diskette flip side, if another "write enable" notch is correctly made.



The **DISK NOTCHER** by QUORUM quickly SOLVES that PROBLEM. It's like FREE DISKETTES!

- Stainless Steel Guide
- Easy Leverage Handle
- Clippings Catcher
- Square Notch Cut

**Certifix™**

NOW for ProDOS & DOS 3.3

**BE SAFE!** CERTIFIX by Quorum protects your ProDOS & DOS 3.3 data by "LOCKING OUT" flawed tracks & sectors. Your disk flip side is **CERTIFIED 100% ERROR FREE.**

- "LOCKS OUT" ProDOS & DOS 3.3 DISK FLAWS
  - AUTOMATIC ProDOS or DOS 3.3 FORMATTING
  - CAN MAKE 35 or 40 TRK ProDOS or DOS 3.3 DISKS
  - APPLE IIc, e, & II+ • NOT COPYPROTECTED
- FREE CERTIFIX BONUS PROGRAMS**
- RESCUE™ RESTORES DELETED DOS 3.3 FILES
  - SPEEDY™ WILL TEST YOUR DISK DRIVE'S SPEED

100% Money Back Satisfaction Guarantee!

**FREE!** Write Protect Tabs & Disk Labels, if you order the DISKETTE FLIP-KIT

**DISKETTE FLIP-KIT (tool, disk, etc.) \$34.95**  
DISK NOTCHER is \$14.95 CERTIFIX is \$29.95  
add \$2.00 s/h • CA add 6 1/2% tax

SEE YOUR DEALER

or order direct from Quorum

**800-227-3800 ext. 30**

VISA, M/C, or C.O.D. Dealers Invited.

**QUORUM INTERNATIONAL, Unltd.**  
INDUSTRIAL STATION P O BOX 2134 AP  
OAKLAND, CA 94614

CIRCLE 223 ON READER SERVICE CARD

Its price of \$1295 does not do much to dispel this perception.

This printer takes a certain commitment to set up and maintain. You'll probably get your hands dirty with this one, since installing the ink cartridges is similar to checking the water level in your car battery. Also, you'll probably need to rinse the ink nozzles once or

**When it comes to printing either color or text, the Diablo C150 printer is hard to beat.**

twice a week and add maintenance fluid on occasion (when the printer tells you to). The bubble gauge in the bottom of the case ensures that you put the C150 on a level surface (it does not like to be tilted more than five degrees), and the power cord that does not disconnect will persuade you to leave it in one location. Lights on the front panel tell you when an ink cartridge is empty, and installing a replacement color cartridge is quite easy when this happens.

When it comes to printing either color or pictures or text, this printer is hard to beat. In addition to the normal character set, the C150 has 29 international text symbols for European applications and an additional 67 "mosaic" characters for graphics applications. The C150 was the only printer we reviewed that could print acceptable overhead transparencies—a definite plus if you give a lot of presentations. Also, printing both text and graphics on the same line is possible with this printer, making it a good choice for those advanced graphics applications.

If speed and fancy text features such as a variety of ready-to-use character pitches, international character sets, and bold print are what you're interested in, however, you might have to look elsewhere. This printer was the slowest in our contest, taking 17 minutes and 45 seconds to print this article. The excellent print quality and bright colors could be well worth waiting for, though.

### How Do You Choose?

Obviously, the printers we have reviewed here are just a sampling of the available ink-jet printers, although far fewer ink-jet printers than impact dot-matrix printers are on the market. Assuming you're sold on the idea of getting one of these quieter printers, how do you choose among the available

ELEPHANT DISKS SS/DD 12.19 SS/DD 12.49 DS/DD 16.99	VERBATIM SS/DD 16.45 DS/DD 22.45 Head Cleaning Kit 5.79	Data Case 8.99
---	--	----------------

## SILICON EXPRESS

CALL We have hundreds of other programs in stock at fantastic savings!

Add'l Fonts & Chars 13.95	Paper Graphics 30.89
Alpha Plot 24.89	Pensate 20.95
Amazon 27.49	PFS: Access 41.99
Apple Mechanic 17.99	PFS: Write 71.99
Arcade Boot Camp 20.95	PFS: File 71.99
Archon 23.99	PFS: Report 71.99
ASC II Pro 77.99	PFS: Graph 71.99
Axis Assassin 14.89	Pinball Construction 23.99
Bag of Tricks 25.89	Pixit 31.89
Bank Street Writer 42.89	Planetfall 23.99
Bank Street Speller 42.89	Practical II 48.95
Baron 32.89	Printographer 23.99
Beagle Bag 18.49	Print Shop 29.89
Beagle Basic 20.99	Print Shop Gr.#1 17.49
Beagle Graphics 34.99	Pronto DOS 18.49
Beneath Apple DOS 13.95	Quest 21.89
Beneath Aple PRO DOS 13.95	Rendezvous w/Rama 27.49
Beyond Cast. Wolf. 24.89	Report Card 36.89
Blazing paddles 34.95	Rescue Raiders 24.95
Bruce Lee 24.95	Sargon III 30.99
Bookends 71.99	Seastalker 23.95
Castle Wolfenstein 19.89	Sensible Speller 71.99
Cat Graphics 20.95	7 Cities of Gold 26.99
Chpshp Load Runner 23.95	Shadowkeep 27.49
Complete Graphics Sys 47.89	Sideways 35.99
Computer Baseball 25.89	Silicon Salad 14.99
Computer Quarterback 27.95	Skyfox 26.99
Copy II - 20.99	Snooper Trps 1 or 2 26.99
Coveted Mirror 20.89	Solo Flight 24.95
Crossword Magic 30.89	Sorcerer 26.99
Crypt of Medea 21.95	Speed Reader II 40.99
Cut & Paste 23.99	Spitfire Simulator 24.89
Cutthroats 23.99	Spy vs. spy 24.95
Dazzle Draw 41.95	Squire 34.95
D-Code 24.89	Standing Stones 13.99
Deadline 29.89	Starcross 29.95
Disk Arranger 20.95	Sticky Bear ABC 23.99
Disk Drive Analyzer 21.95	BOP 23.99
DiskQuick 17.99	Math 23.99
Disk Repair Kit 20.95	Reading 23.99
Dollars & Sense 58.99	Suspect 26.89
Dollars & Sense IIC 69.89	Take 1 36.89
DOS Boss 13.99	Terrapin Logo 59.99
Double-Take 20.99	Think Tank 88.89
Enchanter 23.99	Time is Money 60.99
Essential Data Dup 44.99	Tip Disk #1 13.89
Expedition Amazon 21.89	Transylvania 21.89
Fahrenheit 451 27.49	Triple-Dump 23.99
Fat Cat 20.99	Tycoon 32.99
Financial Cookbook 33.99	Typefaces 11.99
Flex Type 17.99	Typing Tutor III 30.89
Flight Sim II 33.89	Ultima III 34.99
Fontrix 1.5 56.89	Utility City 18.89
Fontpaks 1 thru 11 ea 14.99	Versaform 54.99
Frame-Up 18.89	Visible 6502 31.89
GATO 27.95	Witness 23.95
Graphics Magician 36.89	Wizardry 29.99
GPLE 29.89	Word Attack 29.89
Hard Hat Mack 13.99	Xyphus 21.89
Hitchhiker's Guide 22.99	Zork I 23.89
Home Accountant 47.95	Zork II or III 26.95
Infidel 26.99	80 Col. 64K Card 94.89
I.O. Silver 19.89	Apple Cat II 192.99
Karateka 24.95	Crickit 124.89
King's Quest 34.95	Disk Notcher 8.95
Knight of Diamonds 20.99	Echo + 107.95
Last Gladiator 13.99	Grappler + 84.99
Lazerware Lisa 2.6 53.99	Buffered Grappler + 147.89
Legacy of Lyllygamyn 24.99	Koala Pad 74.89
Locksmith 5.0 64.95	Mach III 33.99
Magic Paint Brush 24.95	Mach II 221.89
Magic Window II 93.89	Microscop IIE 184.89
Map Pack 13.95	Microsci IIC Drive 204.99
Master Type 24.89	Mockingboards CALL
Math Blaster 29.89	Networker 99.95
Maxell Disks LOW	Orange Interface 59.99
Merlin 36.99	Prometheus 1200A 304.99
Merlin Pro 59.99	16K Ram Card 64.85
Merlin Combo 65.99	System Saver Fan 63.89
Mico Cookbook 22.99	Wildcard 2 98.89
Millionaire 32.89	Gemini-10X 234.95
Murder on the Zind. 23.99	Okidata Printers LOW
Music Construction 26.99	Colored printer ribbons CALL
NATO Commander 24.95	Amdk Monitors LOW
One-On-One 26.99	

## SILICON EXPRESS

4555-11 Groves Road  
Columbus, Ohio 43232  
614/868-6868

Your Toll Free Access Outside Ohio  
**1-800-228-0755**

No additional surcharge on MasterCard, Visa, or School purchase orders. Personal checks allow 2 weeks.  
Shipping charges are \$2.50 for software & \$5.00 for printers & monitors. Ohio residents add 5 1/2% state sales tax. Prices are subject to change without notice.

CIRCLE 231 ON READER SERVICE CARD

# A PRINTER SO FAST YOUR APPLE WON'T KNOW WHAT HIT IT.

If you're hunting for the perfect printer for your Apple® II, IIc, IIe or Macintosh,™ there's one way you can't miss. Set your sights on the ProWriter™ 8510SR or 1550SR, from C.ltoh.

Because no matter what your application, this dot matrix printer does the job faster than any other in its price class. At only \$629.

If it's data processing you need, the 8510SR zips out 180 cps, with 100 lines per minute throughput. You can also get draft quality at 120 cps and, as an added feature, beautifully sharp near letter quality printing as well.

For graphics work, the 8510SR prints a full 40% faster than others in its league.

And when it comes to reliability, the ProWriter never falls short of the mark. Because like every C.ltoh printer, the 8510SR has been rigorously tested and proven on the job. And it comes with a full year's warranty, backed by 350 service centers coast-to-coast.

With over a decade of experience, and the strong backing of its 126-year-old, \$60 billion parent company, it's little wonder C.ltoh printers outsell the others by a long shot.

For more information on the ProWriter 8510SR or the wider carriage version 1550SR, see your C.ltoh dealer or call toll free 1-800-423-0300.

Or write C.ltoh Digital Products, Inc., 19750 South Vermont Avenue, Suite 220, Torrance, CA 90502.

™ Macintosh is a Trademark of Apple Computer Corp.  
ProWriter is a Trademark of C.ltoh Digital Products.  
® Apple is a Registered Trademark of Apple Computer Corp.  
© 1985 C.ITOH DIGITAL PRODUCTS, INC.

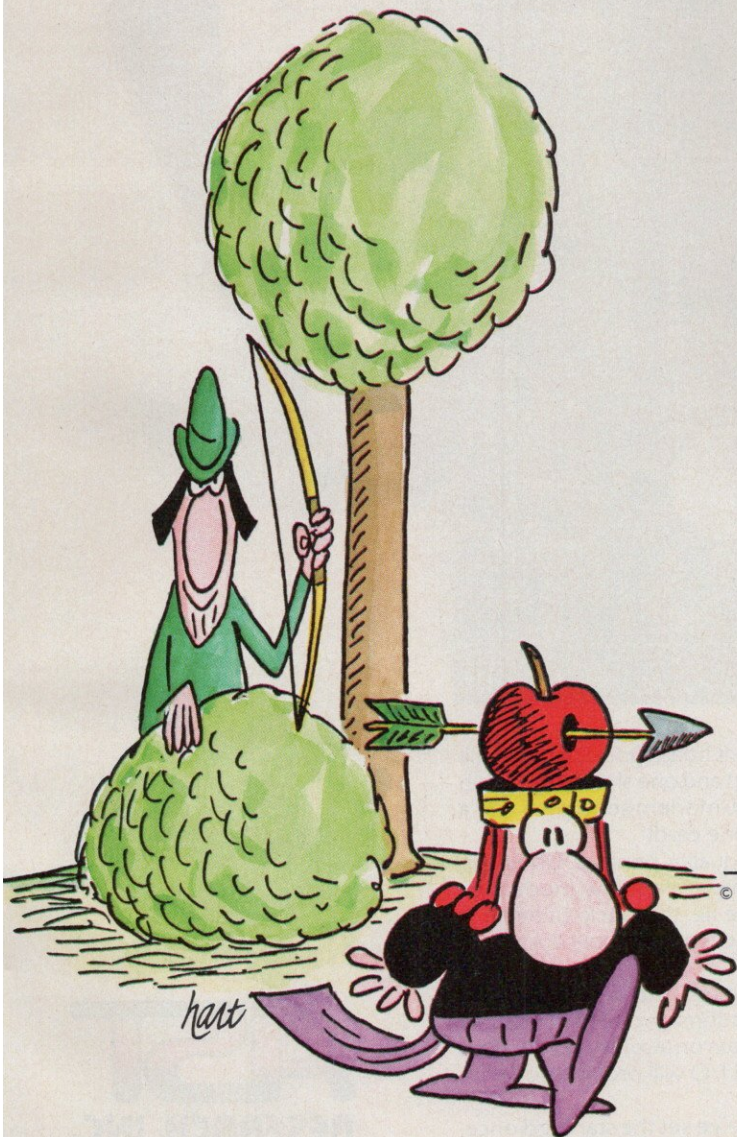

© 1984 News Group Chicago, Inc.



**C.ITOH**  
Printers

CIRCLE 296 ON READER SERVICE CARD

# AST's into Apples!

**Printer  
Serial Port** →

**Terminal/  
Modem  
Serial Port** →

**Clock  
Calendar** →

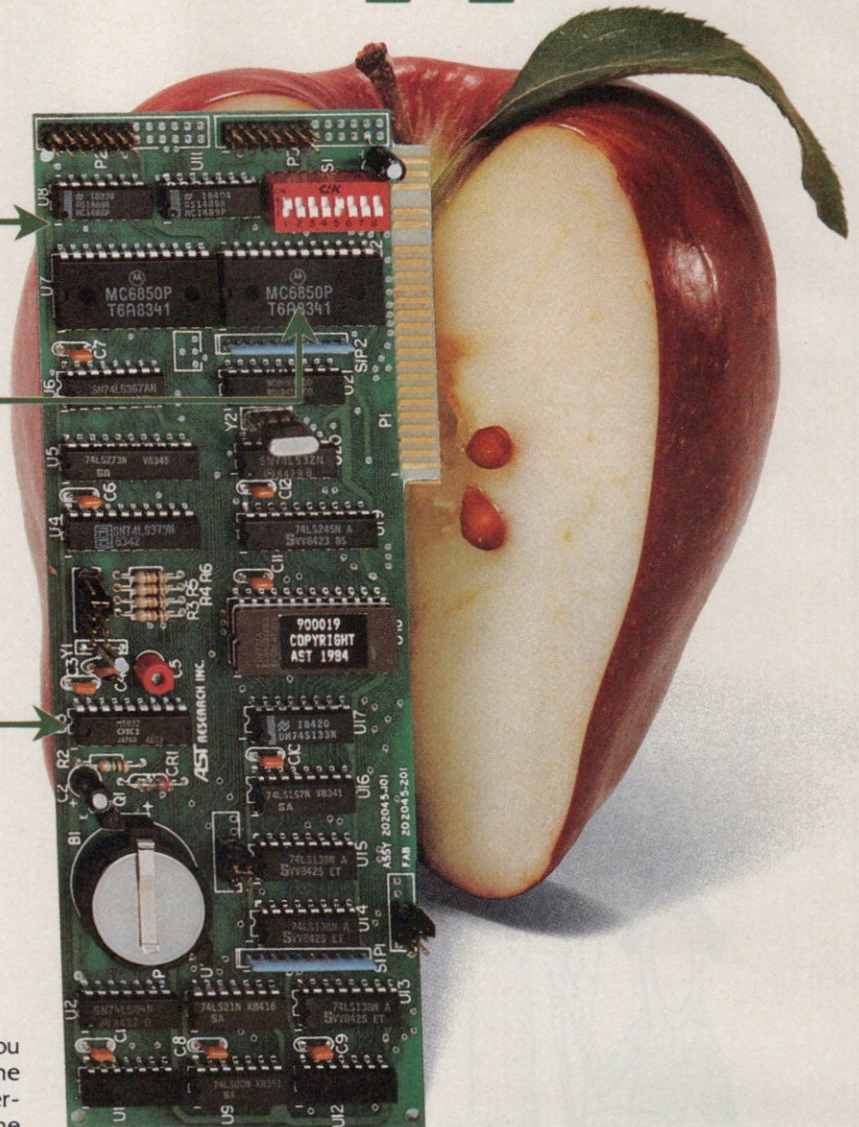

At AST, we are consistently thinking of ways to help you get the most out of your personal computer. We set the standard with enhancement products for the IBM Personal Computer, and now we are striving to do the same for Apple™ computers.

Introducing Multi I/O,™ the most comprehensive enhancement board you can buy to fill the slots in your Apple IIe.™ With Multi I/O, you only need one board and one slot to do the job of three. You see, Multi I/O gives you a printer serial port, a terminal/modem serial port, and a ProDOS™-compatible clock/calendar with battery backup all on one card!

The printer serial port gives you the ability to access letter quality printers. Using the terminal/modem serial port you can communicate with others via a telephone modem or hook up another terminal. And no matter how you use your Apple IIe, the clock/calendar is silently ticking away, providing you with the accurate date and time even when your computer is turned off.

Interested? Wait, there's more. Multi I/O is easy to use and plugs into any of the slots typically designated for one of its three functions. Putting three functions on one card reduces power consumption so you won't have to spend any additional dollars on auxiliary power. And if you compare prices, you'll find that for a few extra dollars, Multi I/O will provide you with three functions instead of one!

So, there you have it, another innovative product from AST. We've set the standard once, and we'll do it again by bringing you the type of quality you expect, but at a very low price. Visit your local computer retailer today, or contact AST Research for a dealer near you.

**AST**  
RESEARCH INC.

2121 Alton Avenue, Irvine, California 92714  
Telephone (714)863-1333 Telex 753699 ASTR UR

models? As always, it's a matter of considering your needs and your budget.

Graphic artists are likely to be more interested in the bright colors and mosaic-character possibilities of a Diablo C150 than in the black-and-white text-printing features of the other printers. A writer or programmer who's on the go and needs something more compact might consider the portability and speed of the HP ThinkJet.

Either way, here are some good questions to keep in mind:

- Do you need to print text and, if so, what quality?
- Do you need color and, if so, what quality?
- What is your spending limit?
- Will the printer work with your computer interface and software?
- Do you need to buy an additional graphics interface?

A good dealer can help you out on the last two questions.

Once you've experienced the golden silence of an ink-jet printer in operation, there may be no turning back. †

*Francesca Venning-Townsley, a writer/instructional designer, has written about computer products since 1982. David Townsley is a product engineer in the semiconductor industry and a frequent contributor to A+.*

#### ► FURTHER INFORMATION

Diablo Systems, Inc.

1510 Trimble Road  
San Jose, CA 95131

(408) 263-7704

CIRCLE 410 ON READER SERVICE CARD

Hewlett-Packard

1820 Embarcadero Road  
Palo Alto, CA 94303

(800) 367-4772

CIRCLE 411 ON READER SERVICE CARD

Quadram Corporation

4355 International Blvd.  
Norcross, GA 30093

(404) 923-6666

CIRCLE 412 ON READER SERVICE CARD

Siemens Communications Systems, Inc.

550 Broken Sound Blvd.  
Boca Raton, FL 33431

(305) 994-8100

CIRCLE 413 ON READER SERVICE CARD

SoftStyle, Inc.

7192 Kalaniana'ole Highway  
Suite 205

Honolulu, HI 96825

(800) 367-5600

CIRCLE 414 ON READER SERVICE CARD



*Somebody up there  
likes us.*

**T**he people at Apple® should know a good peripheral when they see one. And when they developed ProDOS™ to upgrade the Apple II line, they made it automatically recognize and read Thunderclock.

Not surprising, when you consider Thunderclock's long list of useful applications. In the office, the lab and at home. It starts with time and date stamping disk files and just keeps growing. To automatically accessing data bases, sending electronic mail, timing experiments, controlling your sprinklers and even tracking satellites.

*The fact is, the better you are with your Apple, the more useful Thunderclock becomes.*

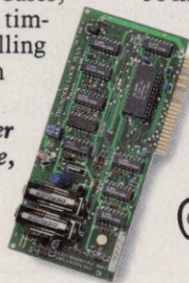

\*Apple and the Apple logo are registered trademarks of Apple Computer, Inc.  
\*\*ProDOS and APPLEWORKS are trademarks of Apple Computer, Inc.  
\*\*\*WORD JUGGLER II is a trademark of Quark Incorporated.

Thunderclock adds a new dimension to all the new ProDOS-based software (like APPLEWORKS™ and WORD JUGGLER II™). And gives you access to the time from years down to milliseconds. It comes with a one-year warranty and never misses a tick. On-board batteries keep it running for up to four years before you snap in a new pair.

So if you want to make ProDOS really produce, turn to page 36 in the *Basic Programming With ProDOS* manual. Then get yourself a Thunderclock. You'll see why somebody up there likes us.

See your dealer or contact us today.



**THUNDERWARE, INC.**

19G Orinda Way  
Orinda, CA 94563  
(415) 254-6581

CIRCLE 226 ON READER SERVICE CARD

# The Apple II... **HOT-LINE**

## A Plug-In 1200/300 Baud Intelligent Modem For Your Apple II... Just \$449 Including Software

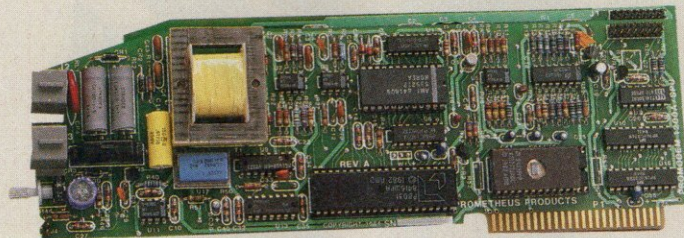

ProModem 1200A is a 1200/300 baud Hayes compatible auto-dial modem card that plugs directly into any expansion slot in the Apple II, II+, or IIe. All you have to do is plug it in and connect the telephone cord.

Ours is the only 1200 baud modem to seriously consider for your Apple II. At just \$449, it's priced well below its nearest competitor, yet it does much more. No longer do you have to buy an external modem, a serial card, an RS232C cable and communications software which, combined, would cost you hundreds of dollars more. There's really no comparison.

ProModem 1200A is the best modem, too. The internal software in its on-board ROM consists of a powerful menu driven terminal program. There is no need for a separate software disk. After a few keystrokes you'll be on-line and communicating.

Features include: Auto-dial/Auto-answer, tone and pulse dial, help commands, built-in diagnostics, two phone jacks, line status detect with redial on busy, full and half duplex and speaker with volume control.

You just can't lose when our plug-in Pro-Modem 1200A comes ready to use, with on-board software, easy to understand documentation and a telephone cord — all for just \$449.

### A Powerful Menu-Driven Terminal Program

<input type="radio"/>	1200A TERMINAL DRIVER
<input type="radio"/>	© PROMETHEUS PRODUCTS INC.
<input type="radio"/>	
<input type="radio"/>	1) COMMUNICATIONS
<input type="radio"/>	2) FILE TRANSFER
<input type="radio"/>	3) OPTIONS
<input type="radio"/>	USE ESC TO EXIT
<input type="radio"/>	ENTER SELECTION
<input type="radio"/>	
<input type="radio"/>	1) BAUD RATE 1200 300
<input type="radio"/>	2) DATA BITS 8 7
<input type="radio"/>	3) PARITY NONE ODD EVEN MARK SPACE
<input type="radio"/>	USE ESC TO EXIT
<input type="radio"/>	ENTER SELECTION
<input type="radio"/>	
<input type="radio"/>	1) TYPE XMODEM LINE
<input type="radio"/>	2) DIRECTION SEND RECEIVE
<input type="radio"/>	3) FILE NAME
<input type="radio"/>	USE ESC TO EXIT
<input type="radio"/>	ENTER SELECTION
<input type="radio"/>	
<input type="radio"/>	1) PRINTER ON OFF
<input type="radio"/>	2) CLOCK ON OFF
<input type="radio"/>	3) STATUS LINE ON OFF
<input type="radio"/>	4) KEYBOARD ON OFF
<input type="radio"/>	5) CAP LOCK ON OFF
<input type="radio"/>	6) ECHO ON OFF
<input type="radio"/>	7) LF AFTER CR ON OFF
<input type="radio"/>	USE ESC TO EXIT
<input type="radio"/>	ENTER SELECTION



*The Hot Line*

**PROMETHEUS**  
**PRODUCTS INCORPORATED**

4545 Cushing Pkwy. • Fremont CA 94538

Call Now For  
Complete Info...  
**415/490-2370**

CIRCLE 122 ON READER SERVICE CARD

The second part  
of a four-part  
tutorial on using  
the language  
of the  
LaserWriter  
printer

## Shaping

# POSTSCRIPT

## To Your Bidding

PostScript, the language built into the Apple LaserWriter printer, has a rich vocabulary for graphics as well as for text. In this second part of the *A+* series on working with PostScript, I'll present some of the simple graphics operations you can do by using an Apple II, Macintosh, or any other computer with a serial port to send PostScript commands to the LaserWriter.

If you caught last month's installment, you'll remember that although you don't have to know anything about the PostScript language to use ordinary software packages with the LaserWriter, learning PostScript can give you better control over printed pages, help you write your own software programs, and provide an interesting peek into another kind of programming.

That's especially true for graphics on the LaserWriter. With a little bit of extra effort and some simple programs, you can turn a LaserWriter into a sketch pad capable of a much finer resolution than a video screen.

### PostScript's Graphics Environment

To begin, let's review the PostScript graphics environment. Using a collection of saved values called the current

graphics state for the defaults, PostScript creates on a page an image that depends on your commands. Those graphics commands, like all other PostScript commands, are written in postfix form, with the operators following

the values they work on.

In the examples that follow, lines that start with the percent sign are program comments. Because of the narrow column widths, I've generally put the comments first, then the command lines they explain. See last month's installment for directions on how to start up the LaserWriter and enter PostScript programs.

### Saving the Current State

The first operation in most PostScript graphics routines is to save the current graphics state. This operation allows us to change the state as we please without worrying about losing the standard values other routines might need. When we're done, we restore the original graphics state. The first and last operational lines of our program, then, are commonly

```
% save the graphics state
gsave
% restore the saved state
grestore
```

Further on, we'll change some of the graphics-state values, but right now it's time to consider the blank page we have to work with. The PostScript page is a two-dimensional space with the origin

PostScript  
can give you  
better control  
over printed pages,  
help you write  
your own software  
programs,  
and provide  
an interesting  
peek into another  
kind of  
programming.

(0,0) point at the bottom left, and a default scale of 72 units to the inch. If you want to switch the drawing point to two inches over and four up, for example, you write

```
144 288 moveto
```

On the LaserWriter, the page is assumed all white unless you have a mark placed on it.

The most common way to make graphic designs on a PostScript page is to create a "path" of connected lines or curves, which you can then make visible, fill, replicate, or use as a template. To create a simple drawing of a house, for example, we might in turn create paths representing the walls, doors, windows, and roof. We tell PostScript when we want to start a path with `newpath`. Our sequence thus far becomes

```
gsave
144 288 moveto
newpath
grestore
```

If we were to add `showpage` at this point, we'd still get a blank page. Moving to a position or defining a path doesn't actually draw the image. To actually draw the image, we create a path and either use `stroke` (to follow the outline of the path, much like inking in a drawing) or the `Fill` command (to color in any area completely enclosed by the current path).

We now have all the elements to draw a small bar across the paper. Write

```
% save the state
% set up a path
% move to the initial position
```

```
gsave
newpath
144 288 moveto

% draw a line
% ink it in
% output the page
```

```
288 288 lineto
stroke
showpage
grestore
```

Now let's expand that a bit to make the program draw a simple box and color it black. We'll tell it exactly where to move for the first point on the box, specify relative movements for three of the sides, and simply tell PostScript to close up the path to make the fourth side. When we have the completed outline, we'll tell PostScript to fill in the square.

```
% set up a path
% set initial position
gsave
newpath
288 288 moveto

% move up, over, down
% complete path
% fill it in
0 144 rlineto
144 0 rlineto
0 -144 rlineto
closepath
fill
```

```
% print out
showpage
grestore
```

Notice that we didn't say explicitly what to fill the box with. PostScript specifies that the fill operator gets the

fill color or pattern from the current graphics state, and on the LaserWriter the initial default fill pattern is black.

Let's see if we can add a round peg to our square hole. PostScript uses simple arcs and more complex Bezier curves (a class of curves connecting four points). We'll stick with the arcs. To make a circle, we start a new path, specify the origin point, give the radius, and finish with the starting and ending angles. A one-inch circle in the middle of a standard page becomes

```
% save
% create a path
% specify the arc
% ink it in
gsave
newpath
288 360 72 0 360 arc
stroke

% show page, restore
showpage
grestore
```

To make this an outline, we follow the `arc` command with `stroke`; to make the circle solid, we follow it with `fill`.

We don't have to choose just a white interior or a solid black fill. By setting the color parameter in the graphics state, we can choose any gradation in between. To set a middle-darkness gray, for example, before executing a fill we write

```
0.5 setgray
```

Although in the narrow context it may seem counterintuitive that leaving the image white requires a color value of 1 and filling with black needs a 0, if you remember that PostScript is a gen-

# Zimco International

85-39 213th Street  
Queens Village, NY

## PRINTERS:

Brother HR-24	\$97	NEC Spinwriter 7710 (55cps)	\$1750
Brother HR-25	\$627	NEC Spinwriter 7720 (55cps)	\$2520
Brother HR-35	\$855	Kiddata 82A	\$302
Brother Sheet Feeder (25/35)	\$180	Kiddata 83A	\$534
Brother Sheet Feeder (15)	\$169	Kiddata 84P	\$650
Brother Tractor (25/35)	\$100	Kiddata 92P	\$345
Brother Tractor (15)	\$90	Kiddata 93P (200cps)	\$565
C. Itoh Starwriter F-1040	\$849	Qume Sprint 11 (40 cps)	\$1277
C. Itoh 1550 P	\$510	Qume Sprint 11 (55 cps)	\$1484
C. Itoh 7500ap	\$220	Qume Sprint 11 (90 cps)	\$1995
C. Itoh Prowriter 8510ap	\$299	Qume Sprint 11 Tractor	\$195
Citizen MSP-10	\$311	Qume Sprint 11 Sheet Feeder	\$270
Citizen MSP-15	\$452	Qume Letter Pro 20	\$435
Citizen MSP-20	\$452	Qume Letter Pro Tractor	\$150
Daisywriter 2000 w/48K	\$875	Panasonic KXP-1090	\$193
Epson HomeWriter	\$249	Panasonic KXP-1091	\$259
Epson FX-80	\$379	Panasonic KXP-1092	\$374
Epson FX-100	\$519	Panasonic KXP-1093	\$619
Epson JX-80	\$497	Panasonic KXP-3151	\$445
Epson LX-80	\$276	Riteman 15 (132cps)	\$434
Epson LQ 1500	\$390	Riteman 120 +	\$239
Epson RX-80	\$225	Silver Reed EXP-400	\$250
Epson RX-80 FT	\$269	Silver Reed EXP-500	\$255
Juki 6100 (L.Q.)	\$399	<b>DISK DRIVES:</b>	
Mannesman Tally MT-160L	\$560	NEC JC 1215MA Color	\$ 175
Mannesman Tally MT-180L	\$729	NEC JC 1201 12" Hi Res	\$ 38
Mannesman Tally Spirit 80	\$293	NEC 1201G	\$ 55
NEC Spinwriter 2000 (20cps)	\$641	NEC 1205A	\$ 78
NEC Spinwriter 3510 RS232C	\$1294	NEC 1260G	\$ 179
NEC Spinwriter 3515	\$1296	Quantum AP 104C Direct	\$ 350
NEC Spinwriter 3530	\$1345	Quantum Duo Disk	\$ 422
NEC Spinwriter 3550 (35cps)	\$1099	Quantin 5 1/4" Controller	\$ 55
		Rana Controller	\$ 78
		Rana Elite I	\$ 179
		Rana Elite II	\$ 350
		Rana Elite III	\$ 552
		Seagate 10 meg Hard disk	\$ 552
		Seagate 10 meg Hard disk	\$ 675

## MONITORS:

Amdek Color IV T	\$575
Amdek 300 Amber	\$125
Amdek 300 Green	\$121
Amdek 300 Color	\$237
Amdek 310 Amber IBM	\$145
Amdek 500 Color	\$327
Amdek 600 Color RGB	\$417
Amdek 700 Color	\$435
Amdek 710 Color RGB	\$553
Amdek RGB DV3 Interface	\$124
BMC Color 919 1U	\$191
BMC 12" Amber	\$115
BMC 12" Green	\$81
Comrex Amber	\$85
Comrex Green	\$85
Comrex RGB 6600	\$219
IBM Monochrome	\$280
NAP Amber	\$231
NEC JC 1215MA Color	\$175
NEC JC 1201 12" Hi Res	\$38
NEC 1201G	\$55
NEC 1205A	\$78
NEC 1260G	\$179

## DISKETTES:

JASF for Mac	\$28.00
Carlton DS/SS w/case	\$14.00
Elephant SS/SD	\$12.50
Elephant SS/DD	\$13.50
Elephant DS/DD	\$16.00
Maxell FD-II 8" DS	\$30.00
Maxell FD-II 8" DS	\$30.00
Maxell 3 1/2" Micro	\$38.00
Memorex for Mac	\$28.00
Nashua DS/DD	\$11.50

## MODEMS:

Anchor Signalmat 300/1200	\$225
Anchor Volksmodem 300	\$490
Anchor Volksmodem 1200	\$179
Anchor Volksmodem Cables	\$ 10
Hayes Smartcom II	\$ 97
Hayes Smartmodem 300	\$140
Hayes Smartmodem 300 (/1c)	\$158
Hayes Smartmodem 1200	\$399
Hayes Smartmodem 1200B	\$349
Hayes Smartmodem 2400 RS232	\$590
Hayes Modem /e	\$145
Novation Access 1-2-3 IBM	\$430
Novation Apple Cat II	\$199
Prometheus Pro-Modem	\$314
Prometheus Pro-Modem 1200 A	\$319

## APPLE ACCESSORIES:

Power Strip & Surge Protector	\$ 16
Cooling Fan	\$ 29
Joystick	\$ 12
ALS Mighty Mac	\$ 69
Echo Speech Synthesizer	\$ 99
Koala Gibson Light Pen	\$170
Koala Pad	\$ 88
Kraft Joystick	\$ 83
Kraft Paddles	\$ 35
Mockingboard A	\$ 78
Mockingboard B	\$ 69
Mockingboard C w/speech	\$199
Mockingboard D for /1c	\$135
RS 232 Cable	\$ 21
TG Joystick	\$ 22
TG Paddles	\$ 30
10 TG Select-A-Port	\$ 29
10 TG Trackball	\$ 39
Thunderclock	\$140
Wico Joystick	\$ 30
Wildcard II	\$ 99

## APPLE CARDS:

Printer Interface, Parallel	\$ 40
Modem Interface (RS232)	\$ 45
Music Card	\$ 69
Clock Card	\$ 54
RGB Card	\$ 45
ALS PrinterMate	\$ 45
ALS Serial Interface	\$ 88
ALS SmartTerm II	\$111
AST Multi Function Card	\$168
OM Grappler +	\$ 79
OM Grappler + Buffered	\$144
OM Grappler + Bufferboard for	\$ 83
OM Grappler + CD	\$ 86
OM Grappler + 16k Buffer	\$770
Grappler + 16k Buffer	\$ 22
MPC Parallel Card w/cable	\$ 50

**FREE SHIPPING**  
(on prepaid orders)

**800-227-6647**  
In NY Call (718) 479-7888

Terms: Any order may be returned within 30 days for full credit subject to a 10% restocking fee. Stock situations may vary. All prices reflect a 3% cash discount. NYS residents add 8.25% sales tax. Personal/corporate checks — allow 2 weeks to clear. Prices do not include shipping and handling charges unless order is prepaid by cash, certified check or money order. Computer sales are not subject to free shipping. Mastercard and Visa do not qualify as prepaid orders. Purchase orders are accepted with prepayment only, except for government agencies. Prices are subject to change without notice. We are not responsible for typographical errors.



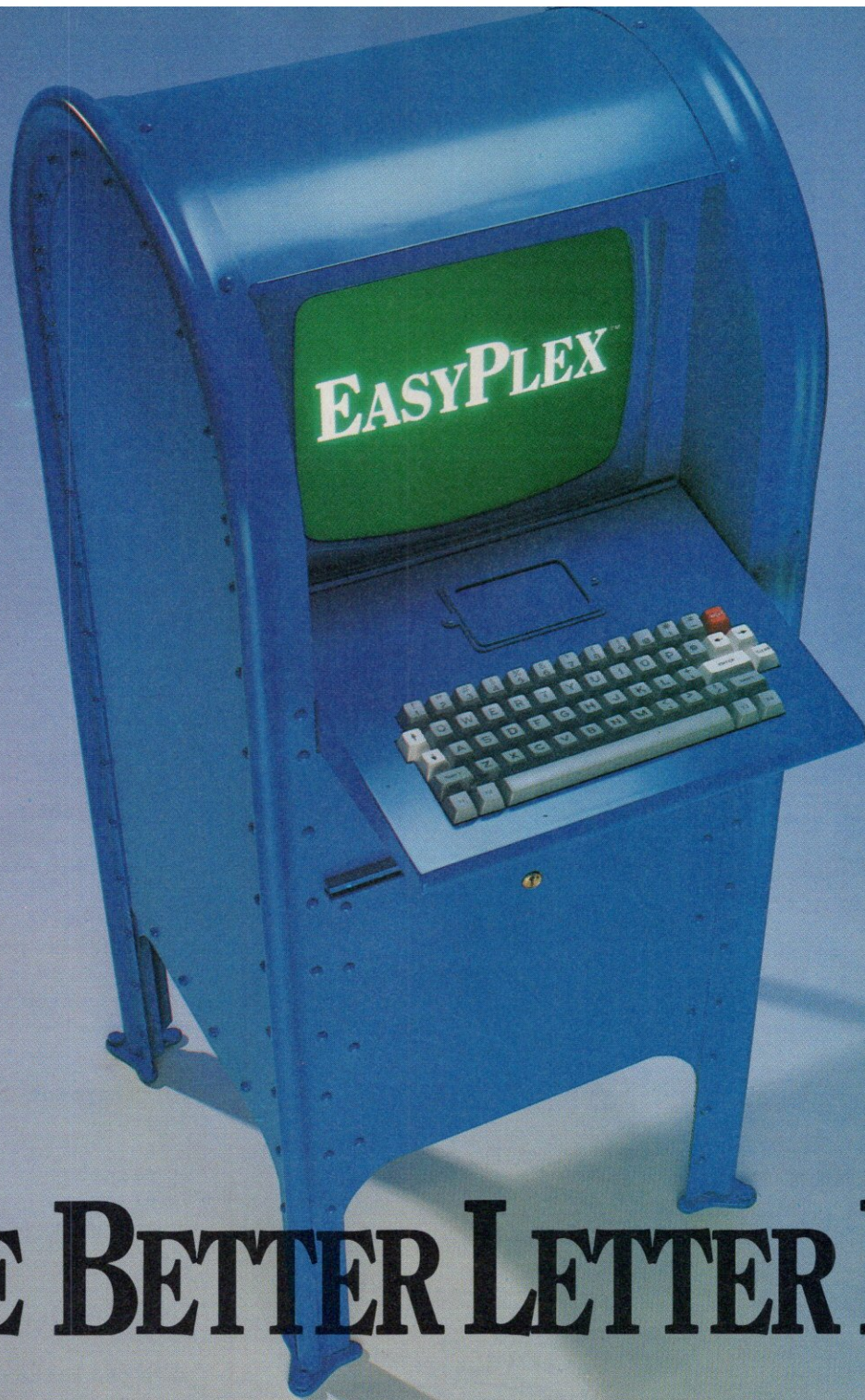

# THE BETTER LETTER BOX

**Introducing EasyPlex™. The new, easy-to-use electronic mail system from CompuServe.**

Finally! Electronic Mail that's so easy to use you can start composing and sending messages the first time you get online.

Designed for various experience levels, EasyPlex has a menu mode with simple, easy-to-follow directions for beginners, and it lets experienced users save time by working in the prompt or command modes. With EasyPlex, you can compose, edit, send, file, and take advantage of sophisticated

options previously available only with more expensive services.

CompuServe's EasyPlex lets friends and relatives, associations and club members communicate any time of the day or night. And small business owners, real estate professionals, insurance agents, lawyers, writers, etc. can communicate quickly and simply—either interoffice or interstate. "It's Easy." "Just Plex it!"

Best of all, EasyPlex is available to all CompuServe subscribers. And, along with EasyPlex, you get hundreds of valuable and entertaining computing options. Plus the assurance of belonging to the largest, fastest

CIRCLE 271 ON READER SERVICE CARD

growing computer information service in the world and the premier supplier of business information to FORTUNE 500 companies.

Start communicating! To buy a CompuServe Subscription Kit, see your nearest computer dealer. To receive our informative brochure or to order direct, call or write:

**CompuServe®**

Information Services, P.O. Box 20212  
5000 Arlington Centre Blvd., Columbus, Ohio 43220

**800-848-8199**

In Ohio, call 614-457-0802

An H&R Block Company

eral solution that is also designed for working with color printers, having more brightness carry the higher value makes more sense. PostScript has still other commands for setting hues (color tones), but naturally they don't do much good on the one-color Laser-Writer.

If we want to outline our arc rather than fill it, we also have a wide variety of choices for the stroke pattern and size. In much the way we can set the brush shape and pattern in MacPaint or MousePaint, we can set the stroke

width and the shape of the corners. Stroke width is another value saved in the graphics state, but we can change it with `setlinewidth`. For example,

```
5 setlinewidth
```

says to set the width to five units wide. The units start out as points, but we can change them and even make the vertical and horizontal units different. We'll have to pass on the whole topic of user coordinate systems, so check the PostScript manual if you want to find out how to make lines that look as if they

came from an italic-nib drawing pen.

Line endings and corners are set by the `linecap` and `linejoin` parameters, also part of the graphics state. We'll draw a few examples in a moment, but here are the possibilities.

Line caps (the ends of lines) can be butt (ending right at the end of the stroke), rounded (semicircles centered at the end of the stroke), or projecting square (boxed with centers at the end of the stroke). Similarly, line joins can be mitered (extended until they meet), rounded (circular with center at intersection), or beveled (flattened connections).

Let's make a series of three half-boxes, each with a different stroke width, line cap, and join. Because we're going to make three identical figures, we'll use PostScript's ability to define a word by pushing a name and deferred procedure onto the stack, followed by the `def` operator to define the name we specified as invoking the procedure.

```
% define a procedure to draw a
% half box
% save current position
% start a new path
% get current position from the
% stack
% move right 1", up 1"
% save current position
% ink in the result, get current
% position from the stack, then
% move over 1"

/halfbox
{ currentpoint
newpath
moveto
72 0 rlineto
0 72 rlineto
currentpoint
stroke
moveto
72 0 rlineto }
def

% save the state
% move to the initial position

gsave
144 144 moveto

% set butt caps and mitered
% joins
% set two unit line width
% invoke the procedure

0 setlinecap
0 setlinejoin
2 setlinewidth
halfbox

% set rounded caps and rounded
% joints
% set five-unit line width
```

## SOFTERM™ 1&2

### MICRO-TO-MAINFRAME

### COMMUNICATIONS AND

### EXACT TERMINAL EMULATIONS

#### SOFTERM 1 CONNECTS YOU WITH INFORMATION SERVICES.

Now you can access information services, bulletin boards, and electronic mail systems from home or office. Softerm 1 includes keyboard macros, a built-in phone book for automatic dialing, simultaneous capture to print or disk, copy screen to print or disk, and terminal status display.

#### SOFTERM 2 CONNECTS YOU WITH YOUR COMPANY'S COMPUTER.

This expanded version of Softerm lets you access the information stored in your company's mainframe. With either version of Softerm, you can download information into your Apple and capture it on your own disk in any format you choose—DOS, CPM™ or Pascal. Softerm's extensive file transfer capabilities provide automatic execution using command files, support for popular protocols like XMODEM, and our own Softrans™ protocol which comes with an adaptable program for your host computer.

#### MAKES YOUR APPLE WORK EXACTLY LIKE ANY MAJOR TERMINAL.

Softerm 2 includes exact emulations of more than 25 popular terminals, and provides all keyboard and display functions. Also, both conversational and block modes are supported.

Apple is a registered trademark of Apple Computer, Inc.

#### SOFTERM CAN'T BECOME OBSOLETE.

We constantly improve Softerm. And we make those improvements available to you 24 hours a day, 7 days a week. To update your program, simply dial our computer and transfer the improvements to your disk.

#### SOFTERM IS A COMMUNICATIONS BARGAIN.

Softerm 1 is only \$135; Softerm 2 is \$195. Plus, you get an unconditional 30-day money-back guarantee. So ask your dealer for a demonstration today.

#### TERMINAL EMULATIONS

TTY Compatible  
 ADDS Regent 20, 25, 40, 60  
 ADDS Viewpoint, Viewpoint78\*  
 Data General D200, D410\*  
 Datapoint 3601, 8220\*  
 Digital Equipment VT52, VT102, VT220\*  
 Hazeltine 1400, 1410, 1500, 1520  
 Hewlett Packard 2622A  
 Honeywell VIP 7205, 7801, 7803  
 IBM 3101 Model 10 and 20  
 Lear Siegler ADM-2\*, ADM-3A, ADM-5  
 TeleVideo 910, 921\*, 925, 950  
 Texas Instruments Model 931\*  
 User Defined  
 \*Coming Soon

Softerm is also available in versions for the IBM PC and Tandy Model 1000 and 2000 personal computers.

## SOFTRONICS

3639 New Getwell, Suite 10, Memphis, TN 38118  
 For orders and information call 901-683-6850

CIRCLE 164 ON READER SERVICE CARD

# INCREDIBLE DATABASE VALUE

*VersaForm is ideal for business because it's based on the way you do business now — your own forms and ledgers.*

## **Powerful, Flexible, Versatile — This is a FULL DATABASE at a Fantastically Low Price!**

Everyone knows how effective a database can be. But until now, they've either been powerful but hard to use, or just simple personal filing systems.

Now VersaForm has made the database both powerful AND easy to use. Because it's based on your own knowledge of business forms, you can tailor it to your own needs. And because it's a full-featured database, it can do the jobs that lightweights just can't handle.

### **Proven In Thousands of Offices**

For over 3 years, VersaForm has been used by manufacturers, bankers, doctors, farmers, and many others. It's THE program for serious business tasks such as invoicing, inventory, and purchasing — in fact, for whatever you've been doing using paper forms and ledgers.

### **VersaForm can:**

- Prevent errors by checking entries before accepting them, according to rules you set up. Saves on operator training!
- Save time by doing calculations automatically.
- Print on existing pre-printed forms — yours or the government's.
- Sort on any item, indexed or not.

- Store up to 4,000 characters in each record, up to 4,000,000 bytes per file.
- Produce the reports you need to manage your business.

### **30 Day/1 Year Guarantee**

- If you're not fully satisfied with VersaForm, return it within 30 days and we'll refund your money.
- Upgrade to our multi-file system, VersaForm XL, within one year, and get Full Credit for the price!

We've SLASHED our prices so you can get to know VersaForm! But hurry — these low prices won't last forever!

### **BONUS OFFER**

Order now and receive your choice of Application Templates for only \$24.95 each (regularly up to \$49.95) — or two for just \$44.95! Choose from Invoicing, Purchase Orders, Mailing List, Check Writing, Cash Receipts, or Expense Journal.

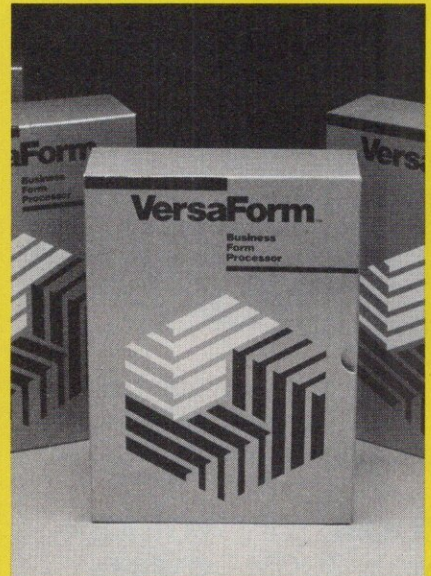

Compare at over

**\$300.**

Now just

**\$69**

Multi-File version \$99 (IBM PC Only)  
Note: Prices subject to change after 60 days.



Credit card members can order by phone.

**Toll-Free: 1-800-538-8157 x: 880**

In California,

**Toll-Free: 1-800-672-3470 x: 880**

APPLIED SOFTWARE TECHNOLOGY  
1350 DELL AVE. STE. #206  
CAMPBELL, CA 95008  
(408) 370-2662

#### **Applied Software Technology**

1350 Dell Ave., Ste. #206 Dept. A7, Campbell, CA 95008

Yes! RUSH me VersaForm for the IBM PC (\$69) \_\_\_\_\_

\* Apple II (+,e,c) (\$69) \_\_\_\_\_

VersaForm XL (MULTI-FILE) for the IBM PC (\$99) \_\_\_\_\_

Your application templates sound GREAT! I understand they cost just \$24.95 each, or \$44.95 for two. Send me the ones I've checked:

Invoicing \_\_\_\_\_ Purchase Orders \_\_\_\_\_ Expense Journal \_\_\_\_\_

Check Writer \_\_\_\_\_ Mailing List \_\_\_\_\_ Cash Receipts \_\_\_\_\_

Enclose check or money order with coupon. Include \$4.50 for U.S. postage and handling, \$7.00 for C.O.D. California residents add 6.5% tax.

\_\_\_\_ My check or money order is enclosed.

Charge my: \_\_\_\_\_ MasterCard \_\_\_\_\_ Visa \_\_\_\_\_ C.O.D.

Acct. No.: \_\_\_\_\_ Expires: \_\_\_\_\_

PLEASE PRINT CLEARLY

Name \_\_\_\_\_

Address \_\_\_\_\_

City \_\_\_\_\_ State \_\_\_\_\_ Zip \_\_\_\_\_

Phone \_\_\_\_\_ Sign here \_\_\_\_\_

\* APPLE II — 64K, 2 DRIVES.

IBM — 2 DRIVES OR HARD DISK. 128K for VersaForm, 196K for XL.

# ZOOM MODEM SALE!

All the Hardware and Software you need at breakthrough prices



Free! With any modem!  
\$200 worth of database subscriptions and connect time  
(Dow Jones, NewsNet or Delphi)

## ZOOM/NETWORKER

Apple/ZOOM Starter Modem **\$99** reg. \$129

- Plug in modem card for the AppleII, II+, and IIe
- ZOOM Communications Software on Disk - DOS and ProDOS Compatible
- Made in USA - 1 year warranty

Also available with ZOOM Advanced Communications, Netmaster Software for file transfer with auto-error correction, text editing, more ..... **\$149** (reg. \$179)

ZOOM/MODEM IIe Advanced AppleModem **\$179** (why pay \$329)

- Plug-in Modem card for the Apple II, II+, and IIe.
- Auto-dial/Auto-answer
- Hayes Micromodem IIe/Smartcom Compatible
- ZOOM Communications Software on disk
- Made in USA - 2 year warranty

Also available with ZOOM Advanced Communications, Netmaster Software. **\$229**

Send check, money order or M/C VISA # with expiration date to:

**The BACH Company**

760 San Antonio Rd.  
Palo Alto, CA 94303

Call TOLL FREE 800-227-8292,  
In CA call 415-424-0800

Figure 1: A series of half boxes demonstrating PostScript's ability to define a procedure and use commands to draw varying line widths, caps, and joins

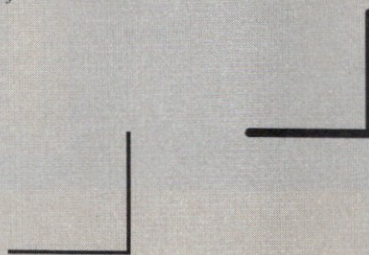
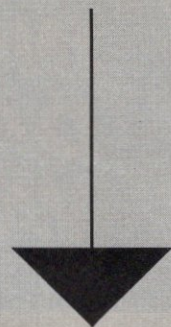

Figure 2: A filled arrowhead and automatically-centering text drawn from PostScript on the LaserWriter printer



That's all, folks

```
% invoke the procedure
```

```
1 setlinecap
1 setlinejoin
5 setlinewidth
halfbox
```

```
% set projecting caps
% and beveled joints
% set ten-unit line width
% invoke the procedure
```

```
2 setlinecap
2 setlinejoin
10 setlinewidth
halfbox
```

```
% print the result,
% reset the state
```

```
showpage
grestore
```

The result should look like figure 1, above. You may not have much call for that particular graphic, but it does illustrate the way PostScript handles simple lines.

For our last example, we'll draw an arrow, followed by a closing message. Write

```
% because we're including text
% we need to set a font (see last
% month for details on fonts)
```

```
gsave
/Times-Roman findfont
12 scalefont
setfont
```

```
% mark the start of the figure
% and start at the middle of the
% page
```

```
newpath
288 500 moveto
```

```
% draw a vertical two-inch line
% with no change in horizontal
% position
% and save the current point
0 -144 rlineto
stroke/currentpoint
```

```
% make the triangular head by
```

```
% moving a half inch up and
% left, an inch right, and then
% closing the path. Save the
% current point. Fill in the
% result and restore the current
% position from the stack
newpath
```

```
moveto
36 36 rlineto
-72 0 rlineto
36 -36 rlineto
closepath
currentpoint
fill
moveto
```

```
% put our text in, make a copy
(That's all, folks) dup
```

```
% find the width, throw out
% the height, divide the result
% by 2, and make it negative
stringwidth pop 2 div neg
```

```
% set -18 points for vertical
-18 rmoveto
```

```
% now show our string, which
% should be on top of stack
```

```
show
```

```
% finally, we print the page
% and restore the state
showpage
grestore
```

The result is shown as figure 2.

If you have trouble following that last part, you might want to try writing it down step-by-step while making a diagram of what's on the stack.

Next month, in the third installment, we'll return to text operations. The fourth and final month will cover how PostScript is used in application programs. See you then. **+**

*Steve Rosenthal first set letterpress type, which seemed conceptually simpler but was not nearly as flexible. It also got his hands a lot dirtier. He's currently an A+ consulting editor.*

# Expanding Your IIC Is Easy With Z-RAM

Applied Engineering and Apple computer have teamed up to take your IIC to new heights.

Applied Engineering's Z-RAM card for the IIC is available with 256K or 512K of additional memory and a powerful Z-80 microprocessor for running CP/M software.

Z-RAM fits neatly inside the IIC. Installation is easy, clear instructions show you how. You'll need a screwdriver and about 10 minutes (if you can change a light bulb you can install Z-RAM).

## Z-RAM and Appleworks will knock your socks off.

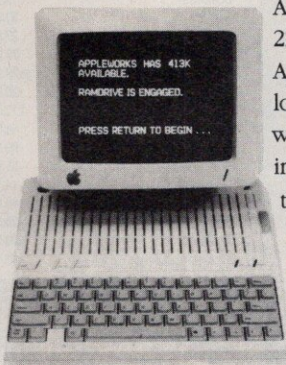

A 256K Z-RAM will give you a 229K available desktop and Appleworks will be completely loaded into memory. Appleworks will now run about 10 times faster in your IIC with 1 disk drive than in other IIC's with 2 disk drives. A 512K Z-RAM will give you a 413K available desktop. A 256K Z-RAM can be upgraded to 512K by just plugging in more memory chips.

Z-RAM is also a high speed solid state disk drive. With Z-RAM, your programs will load and save over 20 times faster. Z-RAM's RAM disk is compatible with Applesoft, ProDOS, DOS 3.3, PASCAL and CP/M. And with Z-RAM, you can copy a disk in one pass. Just insert the original, remove the original, insert blank disk! That's it! Z-RAM is another disk drive, only 20 times faster, 4 times larger capacity, and no whirring, clicking or waiting!

But before you start panting over all that extra memory, don't forget that the Z-RAM card has a built-in high speed Z-80 processor chip that allows you to run CP/M programs like Wordstar, dBASE II, Turbo PASCAL, Microsoft BASIC, FORTRAN and COBOL and over 3,000 other CP/M programs. So Z-RAM not only makes Apple programs run better and faster, it lets you run MORE programs.

With the Z-RAM card installed, your IIC is still your IIC only now you'll have that extra memory that Appleworks

and other programs need. And you can run all that great CP/M software that others can only dream about.

Z-RAM is 100% compatible with all IIC software and hardware including the mouse, 2nd disk, modem and printer. Z-RAM is easily handled by the IIC power supply as power consumption is kept very low by using two custom integrated circuits and a patent pending power saving design. And Z-RAM is from Applied Engineering, the acknowledged leader and innovator of accessories for the Apple.

Z-RAM comes complete with manual, RAM disk software, Z-80 operating system, CP/M manual and a 3 year no hassle warranty.

So the next time somebody asks you why you didn't get an IBM P.C., tell him you bought a IIC because the IBM didn't have enough memory and was too slow and couldn't run CP/M software. And tell him you made it past the 8th grade.

<b>Z-RAM with 256K</b>	<b>\$449</b>
<b>Z-RAM with 512K</b>	<b>\$549</b>

If you want to run CP/M software, but don't need more memory, may we suggest our Z-80c card. The Z-80c offers the same CP/M performance as Z-RAM but has no memory expansion ports. And the Z-80c will not affect the running of Apple programs. The Z-80c is priced at only \$159.00 and should you ever want to upgrade to Z-RAM, we'll refund your full purchase price.

## Call (214) 241-6060

9 a.m. to 11 p.m. 7 days a week or

Send check or money order to:

Applied Engineering  
P. O. Box 798  
Carrollton, Texas 75006



MasterCard



Visa and

C.O.D. welcome. No extra charge for credit cards. Texas residents add 5% sales tax. Add \$10.00 if outside U.S.A.



**APPLIED ENGINEERING**  
"We Set the Standard"



SINCE 1977

# Computer Discount Products

## Monthly Mail-Order Listing FOR APPLE & MACINTOSH

Retail Showrooms In California:  
San Jose • San Mateo • San Francisco

**WE PAY SHIPPING\***  
Get The Details Below!!

### HARDWARE

ALS CP/M Card 3.0	299.99
Dispatcher	104.99
Smarterm II	134.99
Z-Engine	148.99
CDP 16K Ram Card	39.99
Parallel Interface w/Cable	39.99
DAN PAVMAR Lower Case 1	25.99
Lower Case 2, Rev 7	19.99
JOYSTICK Kraft or TG	39.99
MICROSCI A-2 Drive	194.99
Extended 80 Col. - Ile	119.99
Controller Card	79.99
MICROSOFT Soft Card II	329.99
ORANGE MICRO Grappler +	94.99
Buffered Grappler	149.99
Buffer Board	79.99
THUNDERLOCK	109.99
TITAN Accelerator Ile	249.99
Neptune 64K	199.99

### MOCKINGBOARD

Sound Board	79.99
Speech Chips	79.99
Sound AND Speech Ile	145.99
Sound AND Speech Ilc	145.99

### VIDEO 7

RGB Adapter Ilc	149.99
RGB 80i64 Ile	189.99
Slot 7 RGB II + /e	109.99
Mappler Connector	39.99

**KENSINGTON**  
System Saver 65.00  
Masterpiece 100.00

### HOME & BUSINESS SOFTWARE

ASCII Express	84.99
CONTINENTAL Home Acct.	44.99
Tax Advantage	39.99
FINANCIAL COOKBOOK	39.99
MICRO COOKBOOK	32.99
MICROPRO Calstar	69.99
DataStar	204.99
Infostar w/StarCard	174.99
MailMerge	69.99
MICROSOFT Multiplan	149.99
MONOGRAM Forecast	39.99
Dollars & Sense Ile	69.99
Dollars & Sense Ilc	89.99
PFS Rept, File, Graph Write	ea79.99

### WORD PROCESSING

BANK STREET WRITER Ile	44.99
Bank Street for Ilc	49.99
Bank Street Speller	44.99
KENSINGTON Format II	99.99
MICROPRO Wordstar w/CPM	245.99
Wordstar Pro w/CPM	349.99
Pro Options Pak	139.99
SENSIBLE SPELLER	89.99
SIERRA HomeWord	44.99
HomeWord Speller	34.99
Screenwriter II	89.99

### GRAPHICS

BEAGLE Graphics	35.99
Triple Dump	27.99
BRODERBUND Dazzle Draw	44.99
Graphics Library	18.99
Print Shop	29.99
FONTRIX	59.99
PENGUIN Complete Graphics	49.99
Graphics Magician	37.99

**THE NEWSROOM 39.99**

### PRINTERS - MONITORS

TAXAN #115 Green 12"	129.99	EPSON FX-80 + 160 CPS	375.99
#116 Amber 12"	139.99	FX-100 + 160 CPS - Near Let. Qual.	559.99
#120 Color Composite	289.99	LX-80 100 CPS - Near Let. Quality	249.99
#420 Hi-Res RGB 12"	399.99	RX-100 100 CPS - Wide Carriage	399.99
OKIDATA 92 w/Plug 'n Play	459.99	Tractor Feed for FX-80	29.99
PGS HX-12 Hi-Res RGB 12"	459.99	Tractor Feed for LX-80	31.99
USI Pi 4 Amber 9"	99.99	FINGERPRINTS for EPSON	44.99

**KENSINGTON Portable Printer Stand 19.99**

### MODEMS

HAYES 300 Baud	209.99	NOVATION Applect II 300 Baud	198.99
1200 Baud	474.99	Expansion Module	34.99
Micromodem Ile	239.99	J Cat 300 Baud	104.99

### EDUCATIONAL

BARONS SAT	59.99
CBS SAT	94.99
DLM Alien Addition/Minus Mission	ea21.99
Alligator/Dragon Mix	ea21.99
HLS Crossword Magic	39.99
LEARNING CO. Rocky Boots	31.99
Robot Odyssey	31.99
Magic Spell/Number Stumper	ea25.99
Moptown/Reader Rabbit	ea25.99
PEACHTREE SATPSAT	ea34.99
Algebra I-IV	ea25.99
Algebra V-VI	ea32.99

### ENTERTAINMENT

BEAGLE I.O. Silver	21.99
CHAMPION Lode Runner	24.99
DECATHLON	23.99
ELECTRONIC ARTS Archon	29.99
Music/Pinball Construction	ea29.99
One on One/Sky Fox	ea29.99
Seven Cities of Gold	29.99
FLIGHT SIMULATOR	35.99
INFOCOM Enchanter	25.99
Cutthroats/Seastalker	ea27.99
Zork II-III	ea29.99
Hitchhiker Guide	27.99
MASTERTYPE	31.99
NIGHT MISSION PINBALL	25.99
SARGON III	31.99
SIR TECH Knight of Diamond	24.99
Legacy of Lyigarny	27.99
Wizardry	34.99
Wizprint	17.99
Wizplus	23.99
TRILLIUM Amazon	27.99
Fahrenheit 451/Rama	ea27.99
Dragon World/Shadowkeep	ea27.99
WINDHAM CLASSICS	ea18.99
ULTIMA II or III	44.99

**GATO 29.99**  
WWII Submarine  
Simulation

### UTILITIES & ENHANCEMENTS

BEAGLE D Code	29.99
Dos Boss	15.99
Fat Cat	21.99
GPLE	27.99
BORLAND Turbo Pascal	35.99
Toolbox/Tutor	ea29.99
CENTRAL POINT Copy II Plus	25.99
EASTSIDE Wildcard 2	111.99
MERLIN	44.99
VIDEX Enhancer II	99.99
Function Strip	31.99
HardSwitch	14.99
PSIO	145.99
Soft Video Switch	25.99
UltraTerm	229.99
VideoTerm w/Softsw. & Inv.	175.99

### APPLE PREBOOTS

VIDEX Apple Writer	14.99
Apple Writer for Ultraterm	23.99
Visicalc	39.99
Visicalc for Ultraterm	54.99

### DISKETTES & STORAGE

DYSAN 5 1/4" SS/DD	24.99
5 1/4" DS/DD	31.99
MAXELL 5 1/4" SS/DD	18.99
VERBATIM 5 1/4" SS/DD	21.99
5 1/4" DS/DD	27.99
AMARAY 5 1/4" Disk Bank System	22.99
5 1/4" Disk Bank Singles	4.99
Media Mate Hold 50-5 1/4"	11.99
FLIP 'n FILE 50-5 1/4" Original	14.99
50-5 1/4" With Lock	25.99
LIBRARY CASE Holds 10	1.99
PRINTER STAND - Regular	24.99
Titled	29.99
PRINTER STAND - Large	29.99
Titled	32.99
RIBBONS Epson MX/FX80	4.99
Epson MX/FX100	7.99
OkI 82, 83, 92, 93 & Gemini	2.99

### FOR YOUR MACINTOSH

BRODERBUND Lode Runner	27.99	File/Multiplan	ea129.99
CENTRAL POINT Copy II Mac	25.99	MONOGRAM Dollars & Sense	94.99
CONTINENTAL Home Accountant	63.99	Forecast	59.99
FILE VISION	139.99	PFS File	79.99
INFOCOM Cutthroats	27.99	Report	79.99
Enchanter	27.99	File AND Report	155.99
Hitchhiker	27.99	SIERRA Frogger	29.99
Seastalker	27.99	THINK TANK 128K	115.99
Zork II-III	31.99	TRIVIA FEVER Vol. 2	19.99
MICROSOFT Basic	94.99	VIDEX Mac Fun Pak	31.99
Chart	74.99	Mac Vegas	47.99

**MEDIA MATE 3 1/2" Holds 30 Diskettes 9.99**  
**MEMOREX 3 1/2" DS/DD Diskettes 32.99**

**ALL SOFTWARE SHIPPED  
FREIGHT FREE\***  
No Charge For Credit Cards  
Guaranteed Fair Pricing

**ORDER  
# A-7**

# Computer Discount Products

860 So. Winchester Bl., San Jose, CA 95128  
(408) 985-0400 FROM 8AM PST

Purchase Order Prices Differ - Call First • Prices Subject To Change • Software Sales Final  
Please Allow Time For Personal Checks To Clear - \* We Reserve The Right To Charge For Freight On Orders Less Than \$100  
U.S. Mail - \$10 Minimum Chg. • Hardware Shipping - \$CALL

This article is the third in a five-part series about how to use ProDOS. Last month, we looked at some of the Applesoft disk commands whose definitions are in a ProDOS interpreter file (also called a system program) named BASIC.SYSTEM. This month, we'll finish up the discussion of commands by describing all the other standard disk commands and then showing you how to install commands of your own creation.

The syntax of each of the Applesoft disk commands that we'll be discussing below is shown in figure 1 on the following page. Unlike the commands we reviewed last month, most of these commands will never be of use to nonprogrammers, since the majority are for use only within programs—you cannot type them in from the keyboard in the Applesoft Command mode.

This month's commands fall into two distinct groups: file input/output (I/O) commands and miscellaneous commands. Let's look at the former group first.

#### File I/O Commands

You use this group of commands to perform the fundamental disk Input/Output operations that are common to most operating systems: preparing a file for I/O operations (OPEN), reading data from a file (READ), writing data to a file (WRITE), and closing a file after all I/O operations have been performed (CLOSE). In addition, BASIC.SYSTEM defines commands that let you direct subsequent output to the end of a file (APPEND) or access any location within a file (POSITION).

Another command enables you to guard against data loss by saving the contents of a file's data buffer to disk earlier than they otherwise would be (FLUSH).

Before you can begin reading from or writing to a disk file, you must use the OPEN command to request access to the file. (The one exception, as we will see below, is that the APPEND command automatically opens a file that is not yet open.)

BASIC.SYSTEM opens a file by first locating it on the disk and then setting up a 1024-byte (1K) file buffer for it in memory. Half of this buffer

BASIC.SYSTEM initializes two important internal pointers, EOF and MARK, when you open a file. These pointers allow it to keep track of the size of the file and the position in the file that is currently being accessed. EOF is the end-of-file pointer, and it points to the byte following the last byte in the file. MARK is the position-in-the-file pointer; it contains the value of the position at which the next read or write operation will take place. Its setting is 0 (the beginning of the file) when you first open the file, but, as we will see below, it automatically increases as information is read from or written to the file.

Its setting is 0 (the beginning of the file) when you first open the file, but, as we will see below, it automatically increases as information is read from or written to the file.

You usually use OPEN to open a TXT (text) file. (You can use the ,Ttype parameter to deal with any other ProDOS file type.) This is how to open a text file with the pathname /A.PLUS/JULY in an Applesoft program:

```
100 PRINT CHR$(4);
"OPEN /A.PLUS/JULY"
```

This line illustrates the standard way to use disk commands in an Applesoft

program. You use the PRINT statement to print CHR\$(4)—the Control-D code that BASIC.SYSTEM uses to identify its commands—followed, in quotation marks, by the name of the command and its parameters.

If the specified pathname does not exist, a new file entry will automatically be created in the active directory.

You can open files in one of two basic modes: sequential or random-access. A sequential file is one in which the data is stored in a continuous block. If you want to retrieve information from such a file, the computer usually first has to read all the data. If the file is a text file, the block comprises a series of lines of readable text, called fields, each of which is followed by a carriage-return

# UNDERSTANDING ProDOS

**PART THREE OF A CONTINUING TUTORIAL ON THE NEW OPERATING SYSTEM PROGRAM FOR THE APPLE II FAMILY. THIS MONTH WE FINISH UP THE DISCUSSION OF COMMANDS BY DESCRIBING ALL THE OTHER STANDARD DISK COMMANDS AND THEN SHOWING YOU HOW TO INSTALL COMMANDS OF YOUR OWN.**

holds information that tells BASIC.SYSTEM where the file data is located on the disk, and the other half holds the most recently accessed portion of the file.

Whenever you request a read or write operation, BASIC.SYSTEM determines whether the portion of the file to be accessed is already sitting in the buffer. If it is, BASIC.SYSTEM does not need, nor does it bother, to access that portion of the file from the disk. Instead, it simply stores the data in the buffer (a write operation) or reads the data from the buffer (a read operation). Thus, it performs file operations much more quickly than if it used unbuffered disk I/O techniques.

# MORE MEMORY

Let our RAM chips expand your Ramworks card up to 1024k! We can expand your Z-RAM, Titan, Microfazer, Microbuffer, Buffered Grappler, and other cards also. FAST (150 NS), economical chips. GUARANTEED 1 year.

**UP TO 55% OFF!**

	LIST	OUR PRICE
64k Memory Expander Kit	70.	35.
128k Memory Expander Kit	140.	62.
256k Memory Expander Kit	250.	124.
512k Memory Expander Kit	500.	227.
1024k Memory Expander Kit	1000.	424.
AppleWorks Program	250.	210.
Imagewriter (wide)	749.	626.
//e Enhancement Kit	70.	61.
Maxell SS/DD Disks (10)	30.	19.
Slimline Drive //e or //+	259.	178.

**Terms:** For fastest delivery send Cashier's or Certified check, or Money Order. C.O.D. and personal checks accepted (allow 14 days to clear). Add 3% for MasterCard/Visa (include # and expiration). Add \$3 shipping. Texas residents add 6 1/2% sales tax.

Ramworks/Microfazer, Microbuffer, Buffered Grappler, AppleWorks respective trademarks of Applied Engineering, Quadram Corp., Practical Peripherals, Orange Micro, Apple Computer. 256k chips work with Ramworks.Z-Ram cards only. Dealer inquiries welcome.

**COIT VALLEY COMPUTERS (214) 234-5047**  
14055 Waterfall Way Dallas, Texas 75240

CIRCLE 340 ON READER SERVICE CARD

## Commands Syntax

APPEND	pathname (.Ttype) (.L#) (.S#) (.D#)
BYE	
CHAIN	pathname (.@#) (.S#) (.D#)
CLOSE	(pathname)
FLUSH	(pathname)
FRE	
NOMON	
OPEN	pathname (.L#) (.Ttype) (.S#) (.D#)
POSITION	pathname .F# or .R#
READ	pathname (.R#) (.F#) (.B#)
RESTORE	pathname (.S#) (.D#)
STORE	pathname (.S#) (.D#)
WRITE	pathname (.R#) (.F#) (.B#)

Figure 1: The Applesoft disk commands described in this article—brackets enclose optional parameters.

code (usually \$0D, but sometimes \$8D). To open a sequential file, simply leave off the .L# parameter when first opening the file.

A random-access file is one whose organizing principle is a series of fixed-length records that hold related groups of information. Your program can access any record randomly (i.e., without reading all previous records first), simply by specifying its record number when using the READ command (see below). To set the length of the record for a file, use the .L# parameter when you first create the file with the OPEN command. (Recall from last month that # represents a decimal or hexadecimal number.) For example, to open a text file called NAMES with a record length of 128 bytes, you use the statement:

```
100 PRINT CHR$(4); "Open Names, L 128 "
```

The record length you specify in the OPEN command when you first create a text file is displayed in the Subtype column of a CATALOG listing in the form R=\$xxxx. In the above example, the subtype entry would read R=\$0080, since \$80 is the hexadecimal equivalent of 128.

**READ**  
This command is for directing subsequent requests for input (using the Applesoft INPUT or GET command) to an open file instead of the keyboard. If you're accessing a random-access file, you can set the record number to be read with the .R# parameter. For example, to begin reading from the fifth record of our NAMES file, you use this statement:

```
200 PRINT CHR$(4); "READ NAMES, R 4 "
```

This statement sets the MARK position to the start of record 4. (Since the lowest record number is 0, not 1, record 4 is the fifth record.) When the computer reads information from the file, the MARK value automatically increases by the number of bytes read.

You can use two other parameters with the READ command to advance MARK to any position within a record: a field number (.F#) and/or a byte number (.B#). As with the record number, these numbers start with 0, not 1.

If you use more than one of the three-letter parameters (.R# or .F# or .B#), READ will first skip to the proper record number, then to the beginning of the proper field, and finally to the proper byte position within that field.

## WRITE

You use this command to direct subsequent requests for output (using the Applesoft PRINT command) to an

Precision Data Products

**TOLL FREE ORDER LINE**  
**800-258-0028**  
FOR INFORMATION CALL  
**616-452-3457**



C.O.D.



**FREE**  
**FLIP'N'FILE™/15**



Prepacked With 10  
**3M 5 1/4" Diskettes**  
NEW LOW PRICES

SSDDRH ..... \$1.39 Each

DSSDRH ..... \$1.69 Each

**ORDER NOW — LIMITED TIME OFFER**  
"APPLES TO APPLES"  
We will **BEAT** any price on 3M Diskettes in this issue. [Guaranteed same day shipping of in-stock items on orders placed by 2:00 p.m. E.S.T. NEED IT FAST? Ask about 1-DAY AND 2-DAY DELIVERY SERVICE (available for a reasonable upcharge).]

MINIMUM ORDER: \$25.00  
Add 10% for quantities less than 50.  
**Shipping and Handling \$4.00** per 100 diskettes.  
Reduced shipping charge for larger quantities.  
C.O.D. add \$3.00. MI residents add 4% sales tax.





**Precision Data Products**  
P.O. Box 8367, Grand Rapids, MI 49508  
(616) 452-3457 • Michigan 1-800-632-2468  
Outside Michigan 1-800-258-0028

CIRCLE 228 ON READER SERVICE CARD



open file instead of the video screen. It works much like the READ command does, except that information is saved to a file rather than read from a file.

#### APPEND

This command causes two actions: first, it opens a file, and, second, it directs subsequent output to the end of the file by setting MARK equal to EOF. The default file type APPEND uses is a TXT (text) file, but you can change it with the ,Ttype parameter.

Note that if you use APPEND with a random-access text file and specify a ,L# parameter that is the same as the file's record length, MARK is actually set equal to the beginning of the record immediately following the last record in the file.

#### POSITION

This command lets you skip over a specified number of fields in a file. The number of fields is determined by the value of the ,F# or ,R# parameters (they are equivalent). After you issue a POSITION command, the MARK pointer is set to the byte following the carriage-return code in the last skipped field, and subsequent read or write operations will take place at this position after you specify another READ or WRITE command.

#### FLUSH

The FLUSH command forces any data in the file buffer to be saved to disk, even if the buffer is not yet full. This command minimizes the risk of data loss in the event of an unexpected exit from the program (due to a loss of power, pressing Reset, or the like), but it slows down disk write operations considerably. If you use FLUSH without a pathname, the buffers for all open files will be flushed.

#### CLOSE

With this command, you can close a file that you've opened with the OPEN or APPEND command. When a file is closed, its buffer is automatically flushed, and its new size is stored in the directory. If you use CLOSE without a pathname, all open files will be closed.

**A**lthough you don't have to close a file immediately after you finish with it (you could wait until the program is about to end), it makes sense to do so in order to reduce the risk of data loss that would occur in the event of a power loss or system reset. In addition, BASIC.SYSTEM allows only eight files to be open simultaneously, so if you have a lot of inactive, but open, files lingering around, you may face a surprising error message the next time you open a file. Another reason for closing unused files is to free up the 1K buffer space an open file uses.

#### MISCELLANEOUS COMMANDS

The remaining Applesoft disk commands do not fall neatly into any specific category, so we'll lump them together and call them miscellaneous commands. Let's get right to them.

#### BYE

This command lets you transfer control from BASIC.SYSTEM to another ProDOS system program. A system program is one that takes over the entire system (except the lowest-level ProDOS subroutines) to perform a specific chore, such as defining a programming environment or performing a particular function. Examples of system programs are the FILER and CONVERT utilities (you can find them on the ProDOS users' diskette) and the AppleWorks integrated-software system.

When you enter BYE, ProDOS first asks you to enter the prefix and then the pathname of the next application to be run—it must be a ProDOS system program.

## LEROY'S CHEATSHEET®

APPLE IIe KEYBOARD OVERLAYS

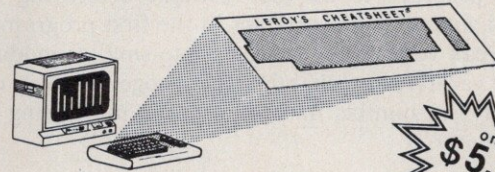

only  
**\$5.95**  
each

FOR APPLE IIe

LEROY'S CHEATSHEETS® are plastic laminated keyboard overlays designed for use with popular software and hardware for APPLE computers.

These DIE-CUT overlays are designed to fit over the keyboard surrounding the keys with commands and controls grouped together for easy references.

LEROY'S CHEATSHEETS®  
make life easier for you

APPLE IIe KEYBOARD OVERLAYS

- BLANKS (set of 3)
- FLIGHT SIMULATOR II
- LOGO (Terrapin)
- GRAPPLER + with PRINT SHOP
- EPSON RX & FX 80 & 100
- GEMINI 10X & 15X PRINTER
- OKIDATA MICROLINE 92 & 93 PRINTER



A+6

Qty.     X \$5.95 \$    

\* Shipping & handling \$     **1.00**

6% sales tax \$      
(PA residents only)

**TOTAL** \$      
U.S. FUNDS  
NO COD'S PLEASE

\* **SHIPPING AND TERMS:** US and Canada \$1.00 per order. Foreign orders \$3.00. Cash, certified check or money order. Phone orders are Visa and Mastercard only. No COD's.

Dealer inquiries welcome

Name \_\_\_\_\_

Address \_\_\_\_\_

City \_\_\_\_\_ State \_\_\_\_\_ Zip \_\_\_\_\_

**CHEATSHEET PRODUCTS inc**  
P.O. Box 111368 Pittsburgh PA. 15238



(412) 781-1551

Charge My VISA or Master Card NUMBER      EXPIRATION DATE

\_\_\_\_\_

... OR SEE YOUR LOCAL DEALER !

CIRCLE 138 ON READER SERVICE CARD

## CHAIN

You use this command to transfer control from one Applesoft program to another without destroying the names and values of the variables in the first program. It lets you break very large programs into smaller modules that share variables by chaining them together. You can chain to any line number in the new program by using the `.@#` parameter.

## FRE

This command is for packing the Applesoft string-variable storage space in the upper part of memory. It removes former string definitions from the space and moves the active strings together into a continuous block. This procedure is called garbage collection or, more euphemistically, housecleaning and works much more quickly than the Applesoft command of the same name.

## STORE

This command lets you save the names and values of all the variables in an Applesoft program to a file. The mnemonic for the file-type code assigned to the file is VAR.

## RESTORE

This command is used to set the names and values of the variables in an Applesoft program equal to those contained in a specified file. This file must be of the type VAR (the type the STORE command creates).

## NOMON

BASIC.SYSTEM accepts this command, but it does nothing. Apple included it in the command set for DOS 3.3-compatibility reasons. The DOS 3.3 version disables the display of disk commands and input/output operations, but under BASIC.SYSTEM they are always disabled, anyway.

## USER-DEFINABLE EXTERNAL COMMANDS

We have now looked at all 32 disk commands BASIC.SYSTEM defines, but we're not through yet. One of the most useful features of BASIC.SYSTEM is that you can extend its command set by installing user-defined external commands that perform a myriad of other useful functions. Unfortunately, to write the code to support such commands, you must master the art of 6502 assembly-language programming. On the other hand, if someone does the writing for you, all you have to know is how to install and use the external commands.

When BASIC.SYSTEM encounters a command it doesn't recognize, it does not immediately display an error message; it calls a three-byte jump instruction at EXTRNCMD (\$BE06) to see if the command is claimed by a user-installed external-command handler (the handler's address is stored at \$BE07 and \$BE08). If no external-command handler has been installed, EXTRNCMD will jump to a "do-nothing" RTS ("return from subroutine") instruction at XRETURN (\$BE9E).

If the external-command handler does not claim the command, and if command entry was from within a program, you'll get a BASIC.SYSTEM syntax-error message. If, on the other hand, the command was entered in the Applesoft Command mode, it will pass on for consideration by the Applesoft ROM interpreter; only if the interpreter does not recognize it will an Applesoft syntax-error message appear.

Suppose that a properly designed external-command handler has been installed, so that a call to EXTRNCMD will pass control to it. This handler first executes the CLD

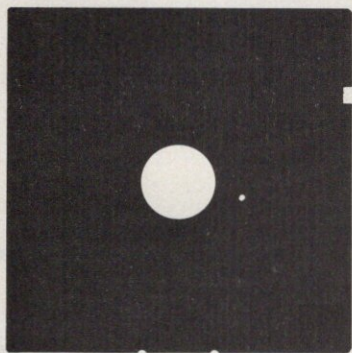

**The loss of data contained  
on this \$3 diskette could  
cost you or  
your company  
\$thousands\$.**

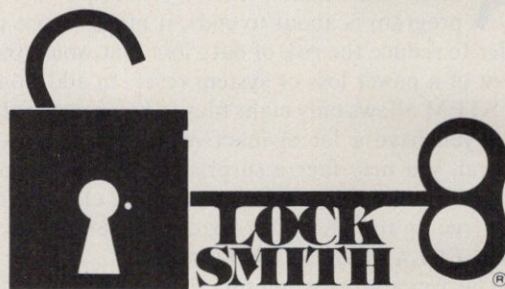

**That's why you need**

Even the highest quality diskettes are very delicate. They are easily damaged by magnetic fields, sharp objects, spilled sodapop, and peanut butter.

Locksmith backs up your data faster than ANY other backup utility available for the Apple. (Locksmith Version 5.0 can reliably backup a disk in as little as 8 seconds!)

Locksmith can backup programs which the manufacturer didn't intend for you to backup, (so-called protected software). Let's face it—the company that sold you your software yesterday may not be around tomorrow.

We are the SOURCE for Locksmith 5.0, it's our product. We are so totally committed to providing the best support for Locksmith that we hired the author of Locksmith and the entire Locksmith programming team to support Locksmith for you.

Locksmith currently comes with backup parameters for hundreds of "protected" programs.

Locksmith at \$99.95—the best insurance value for your software investment.

Available from your local dealer or order direct from:



**Alpha Logic Business  
Systems Inc.**

4119 North Union Road  
Woodstock, IL 60098  
(815) 568-5166

Visa & Mastercard accepted  
As the manufacturer of Locksmith,  
we invite all dealer inquiries.

**Coming Soon—  
Locksmith/PC and  
MAC-Locksmith**



# MAIL ORDER PRICES!



## A NEW KIND OF COMPUTER STORE WE DISCOUNT EVERYTHING!

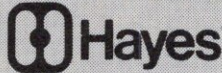

**SMARTMODEM 300**  
**SMARTCOM I IIC...** 169.95  
**1200 SMARTMODEM...** 399.95  
**1200 B (IBM).....** 379.95  
**MICROMODEM IIC...** 159.95

**2400 SMARTMODEM .....** 599.95  
**APPLEWORKS.....** 209.95  
**ASCII PRO IBM..119.95 AP..** 89.95  
**BANK STREET WRITER IIC..** 49.95  
**BANK ST. WRITER II+, IIC...** 49.95  
**BANK STREET SPELLER.....** 49.95



**ACCELERATOR II+, IIC** 229.95  
**128K RAMCARD APPLE** 199.95  
**III + II CARD (AP III)** 299.95  
 RUN ALL II+ SOFTWARE ON YOUR III  
 INCL 128K RAM, II+ JOYSTICK PORT &  
 RAMDISK SOFTWARE

★ **DANA SUPER FAN** 29.95  
 SURGE SUPPRESSOR, 2 GR. OUTLETS,  
 FRONT SWITCH FOR APPLE II, II+, IIC

**D BASE II APPLE.....** 199.95  
**DB MASTER IV+ APPLE ....** 189.95  
**DAZZLE DRAW .....** 39.95  
**FLIGHT SIMULATOR II .....** 36.95  
**HITCHHIKER'S GUIDE AP/IBM.** 29.95  
**GATO APPLE/IBM .....** 27.95  
**KARATEKA .....** 26.95  
**MATH BLASTER .....** 34.95  
**NEWSROOM .....** 34.95  
**NORTON UTILITIES 3.0 .....** 69.95  
**SIDEWAYS IBM, AP .....** 44.95  
**TYPING TUTOR III AP/IBM ..** 36.95

### FONTRIX:

**FONTPAKS 1 THRU 11 EA...** 19.95  
**FONTRIX (APPLE) .....** 69.95  
**FONTRIX (IBM) .....** 99.95

**HOME ACCOUNTANT MAC ...** 69.95  
**APPLE..49.95 IBM..89.95**  
**MEGAWORKS SPELL CHCK & MAIL**  
**MERGE FOR APPLWRKS...** 89.95  
**MANAGING YOUR MONEY...** 109.95  
**LOCKSMITH 5.0 .....** 79.95  
**MIND PROBE AP, IBM.....** 29.95  
**EARLY GAMES AP/IBM.....** 21.95  
**FORMAT II .....** 99.95

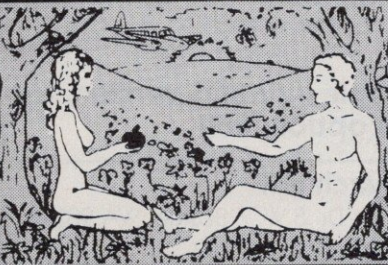

### HARDWARE

**IIC MOUSE .....** 49.95  
**1/2 HGT DRIVE II+, IIC.....** 149.95  
**1/2 HGT DRIVE IIC.....** 159.95  
**PROMETHEUS 1200A.....** 329.95  
**PADDLE ADAPPLE.....** 26.95  
**APPLE CAT II .....** 199.95  
**CH MACH III JOYSTICKS .....** 39.95  
**KOALA PAD APPLE .....** 77.95

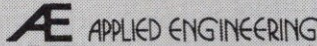

**Z-80+ .....** 129.95  
**TIMEMASTER .....** 109.95

### ★ RAM WORKS ★

**IIC80 COLCARD EXPANDS AN APPLE**  
**UP TO 1 MEG AND APPLEWORKS**  
**UP TO 800K.....** from 159.95  
**Z-80 C (CP/M IIC).....** 139.95  
**Z-RAM IIC 256K.....** 359.95  
**512K.....** 499.95

**RF MODULATOR.....** 24.95  
**SYSTEM SAVER FAN.....** 64.95  
**THUNDERCLOCK .....** 109.95  
**PROMODEM 1200.....** 299.95

**GRAPPLER+ .....** 79.95  
**BUFFERED**  
**GRAPPLER 64K.. 159.<sup>95</sup>**

### PRINTER SALE

**HR 15 XL, 17 CPS.....** 369.95  
**EPSON FX 100+.....** 499.95  
**EPSON FX 80 FT+ .....** 349.95  
**GEMINI SG 10 .....** 239.95  
**OKIDATA 192 (AP, IBM) ...** 359.95  
**OKI 192 (IIC, LISA, MAC) ...** 449.95  
**OKIDATA 193 (AP, IBM) ...** 499.95  
**OKIDATA 182.....** 229.95  
**PANASONIC 1091.....** 269.95  
**C ITOH PROWITER**  
**8510 120 CPS .....** 299.95  
**8510+ 120 CPS NLQ....** 319.95  
**SILVER REED #550 LQ....** 419.95  
 ★ **PRINTER STAND WITH SLOT** ★  
**WIDE...26.95 REG...19.95**



### ULTRATERM

40-80-96-132-160 COL

**SPECIAL LOW PRICE 179.95**

**APPLEWORKS II+... 39.95**  
 NEW APPLEWORKS PREBOOT DISK  
 REQUIRES 64K & VIDEX 80 COL CARD  
**16K RAMCARD.....** 69.95

**BECAUSE HARDWARE AND SOFTWARE**  
**PRICES ARE CHANGING SO RAPIDLY,**  
**WE URGE YOU TO CALL FOR OUR VERY**  
**LOWEST CURRENT PRICES!**  
**WE APPRECIATE YOUR BUSINESS** and will do  
 everything we can to make you happy.

**TERMS:** F.O.B., Westminster, CA. We accept VISA,  
 Mastercard, Cash, Money Orders, Checks, Certified  
 Checks are better. Purchase Orders (2% 10-Net 15).  
 Add 2% for bank cards & P.O.'s. Ask about our return  
 policy. Prices are subject to change and hopefully will  
 go down. Subject to stock on hand. Unless otherwise  
 noted, all prices are Apple.  
 Apple is a registered trademark of Apple Computer.

### MICROSOFT.

**PREMIUM SOFCARD .....** 249.95  
**MULTIPLAN AP DOS.....** 69.95  
**ALL MAC CHART .....** 79.95  
**FOUR MULTIPLAN .....** 119.95  
**PIECES MAC WORD.....** 119.95  
**399.95 MAC FILE.....** 119.95  
**FLIGHT SIMULATOR .....** 36.95  
**MAC BASIC .....** 99.95

**SOURCE .....** 39.95  
**DISK NOTCHER .....** 12.95  
**DISKETTE CASE 80-100 .....** 12.95  
**COMPUSERVE .....** 22.95  
**COMPUTER PAPER .....** 4.95



**EACH (IBM) ....** 79.95  
**FILE (AP) .....** 69.95  
**GRAPH (AP) .....** 69.95  
**REPORT (AP) ...** 69.95  
**WRITE (IIC, IIC)...** 69.95  
**PAK: FILE/REPORT(MAC)...** 149.95  
**FILE (MAC).....** 69.95  
**REPORT (MAC) .....** 69.95

**PRINT SHOP ... 32.95**  
**PRINT SHOP REFILLS.....** 11.95  
**GRAPHICS LIBRARY.....** 19.95

**MAC THE KNIFE I.....** 29.95  
**BARRON'S SAT .....** 69.95  
**EDD III .....** 55.95  
**TAKE 1 .....** 44.95  
**TAX ADVANTAGE (AP, IBM) ...** 44.95  
**BARRON'S SAT AP/IBM .....** 69.95  
**Lotus 1-2-3 PC & PC JR. 95**  
**329**  
**SYMPHONY.449.95**  
**SPY VS. SPY .....** 24.95  
**TURBO PASCAL APPLE .....** 49.95  
**WORD ATTACK .....** 34.95

### — DOLLARS & SENSE —

**APPLE II+, IIC .....** 69.95  
**MAC...99.95 IIC...79.95**  
**IBM W/FORECAST .....** 109.95  
**FORECAST MAC..59.95 AP..49.95**

**CROSSWORD MAGIC.....** 44.95  
**COPY II**  
**(AP, IBM OR MAC) .....** 29.95  
**WORD JUGGLER.....** 149.95  
**WIZARDRY IV.....** 34.95  
**SPEED READER II.....** 44.95  
**SENSIBLE SPELLER .....** 64.95  
**TRIVIA FEVER .....** 27.95  
**31 PROGS FOR THE MAC....** 29.95

### GARDEN OF EDEN COMPUTERS

16485 Magnolia, Westminster, CA 92683

1/2 Block North of the 405 Freeway

Mon-Fri 10-6:30 Sat 10-5

CLOSED SUNDAYS & TUESDAYS

**800-762-3227**

OUTSIDE CALIFORNIA ONLY

7/85 714-841-4994

**800-331-0045**

INSIDE CALIFORNIA

Location	Symbolic Name
\$BE58-\$BE59	APARM A (address) parameter
\$BE5A-\$BE5C	BPARAM B (byte #) parameter
\$BE5D-\$BE5E	EPARM E (end addr) parameter
\$BE5F-\$BE60	LPARM L (length) parameter
\$BE61	SPARM S (slot) parameter
\$BE62	DPARM D (drive) parameter
\$BE63-\$BE64	FPARM F (field #) parameter
\$BE65-\$BE66	RPARM R (record #) parameter
\$BE68-\$BE69	@PARAM @ (line #) parameter
\$BE6A	TPARM T (file type code) parm
\$BE6B	SLPARAM "snum" parameter
\$BE6C-\$BE6D	PATH1 pointer to 1st pathname
\$BE6E-\$BE6F	PATH2 pointer to 2nd pathname

Figure 2: BASIC.SYSTEM parameter table—the BASIC.SYSTEM parser stores the value of a specified parameter in this table.

("clear decimal flag") instruction that future versions of BASIC.SYSTEM will use as an identification byte. The handler then determines whether this command has, in fact, been entered; it can do so by checking to see if the first few characters in the command line match the expected command string. (The command line is stored in Apple's standard input buffer, beginning at \$200, in ASCII-encoded form, with the high bit of each code set to 1.) If they don't, the subroutine must end with the 6502 carry flag set to indicate that the command was not claimed.

If the external-command handler detects the correct command, it can ask BASIC.SYSTEM to parse parameters from the command line and do syntax checking. It makes this request by setting certain bits in PBITS (\$BE54) and PBITS+1 (\$BE55).

With three exceptions, the handler uses each bit in

PBITS and PBITS+1 as a flag to indicate whether the particular parameter associated with that bit is required or allowed. The exceptions are bits indicating particular characteristics of the command: whether a prefix must be fetched for it, whether it is valid in the Applesoft Command mode, and whether a specified file should be created if it doesn't already exist. The meaning of each bit is as follows:

#### PBITS (\$BE54)

- bit 7 Fetch the current prefix if a pathname is not specified.
- bit 6 A slot number is required (e.g., IN#, PR#).
- bit 5 The command is not valid in the Applesoft Command mode.
- bit 4 A pathname is optional.
- bit 3 Create a file if the specified one does not exist.
- bit 2 The T parameter is allowed.
- bit 1 A second pathname is required (e.g., RENAME).
- bit 0 A pathname is allowed. If the external-command handler sets the S and D bit of PBITS+1 to 1, a pathname is required.

#### PBITS+1 (\$BE55)

- bit 7 The A parameter is allowed.
- bit 6 The B parameter is allowed.
- bit 5 The E parameter is allowed.
- bit 4 The L parameter is allowed.
- bit 3 The @ parameter is allowed.
- bit 2 The S and D parameters are allowed.
- bit 1 The F parameter is allowed.
- bit 0 The R parameter is allowed.

## word processing with **zardax**



for old hands  
... or new

All the power you need at the office.  
Large documents. "Chaining" for long reports.  
Mail merge and glossary phrases.  
All the standard editing features.  
Supports over 40 printers. Commands for complex formatting. Print preview.  
Printer spooling in the background.

All the simplicity you need at home or school.  
Sample documents on disk.  
Lessons disk available for educators.  
Manual tutorial. Written in English.  
Memorable commands that make sense.  
No need to remember printer control codes.

**Apple ][+, //c, //e. Your choice of DOS or ProDOS. Apple /// SOS version, too.  
All: \$210. Zip-Comm modem communications option: \$80.**

At your dealer, or from us.  
Zardax™ Computer Solutions, Australia  
Apple™ Apple Computer, Inc.

**Action-Research NW**  
11442 Marine Vw. Dr. S.W. / Seattle, WA 98146  
(206) 241-1645 / Source: CL2542

# NEW LOW PRICES FROM THE WORLD'S LARGEST SPORTS SOFTWARE COMPANY!

Whether you're a coach, player, computer bug, statistician, dabbler, doer or just a real sports fan, PDS has a package for you... at our lowest prices ever! Check our line-up below, and then order your first PDS Sports Package.



**FOOTBALL STATISTICS.** A comprehensive computer software system. You compare teams in over 60 offensive and defensive situations and watch the matchups on the screen. Every team is given a power rating. PDS also provides "year-to-date" data diskettes for a nominal charge. 39.95

**FOOTBALL HANDICAPPING.** (Includes FOOTBALL STATISTICS Package). Forecasts the outcome of football games based on massive amounts of statistical data, morning lines and point spreads. 49.95



**BASKETBALL STATISTICS.** The most comprehensive basketball program ever written. "What-if" your way into every imaginable comparison and formulation. 39.95

**BASKETBALL HANDICAPPING.** (Includes BASKETBALL STATISTICS). Gives you an inside look into the outcome of games by mathematically equating statistics, lines and point spreads. 49.95



**BASEBALL STATISTICS.** See how opposing baseball teams stack up against each other. See summarizations. Performance stats on every team in the major leagues. 39.95

**BASEBALL HANDICAPPING.** (Includes BASEBALL STATISTICS) Makes you better-prepared to predict the winner of any game. At least, mathematically. 49.95



**THOROUGHBRED HANDICAPPING.** This "world class" program gives you an edge in predicting winners. A proven system... by PDS and many horseracing enthusiasts. 129.00



**HARNESS RACE HANDICAPPING.** The fast, easy way to find out what races and what horses should be looked at... all summarized in a "power rating" format. 129.00



**QUARTER HORSE HANDICAPPING.** the computer system actually "rates" the horses in each race of what is the fastest growing segment in the sport of kings. 129.00



**TRAINER STATISTICS.** Analyzes all local race-horse trainers and gives you a rating for each one. 39.95



**JOCKEY STATISTICS.** A short time with this software package will show you why the top 15 jockeys at local tracks win over 90% of all races. 39.95



**HARNESS DRIVER STATISTICS.** A complement to the HARNESS HORSE HANDICAPPING System, this package tells you all you need to know about the man (or woman) behind the horse. 39.95

## PDS SPORTS™

P.O. BOX E / TORRANCE, CA 90507 / (213) 516-6688  
Please send me the following PDS SOFTWARE PACKAGE:

\_\_\_\_\_ \$ \_\_\_\_\_  
 \_\_\_\_\_ \$ \_\_\_\_\_  
 \_\_\_\_\_ \$ \_\_\_\_\_

Total

Add \$6.00 for postage and handling.  
 Calif. residents add 6½% sales tax  
 I have an APPLE ( ) IBM ( ) TRS-80 ( )  
 COMMODORE-64 ( )  
 DISKETTE ( ) CASSETTE ( ); MODEL # \_\_\_\_\_  
 ( ) Check enclosed  
 ( ) Charge my credit card: A.E. ( ), VISA ( ),  
 M.C. ( )  
 Card No. \_\_\_\_\_ Expires \_\_\_\_\_  
 Signature \_\_\_\_\_

(As it appears on credit card)

OR CHARGE BY PHONE...CALL (800) 222-2601  
 (In Calif: (213) 516-6688)

NAME \_\_\_\_\_  
 ADDRESS \_\_\_\_\_ PHONE \_\_\_\_\_  
 CITY \_\_\_\_\_ STATE \_\_\_\_\_ ZIP \_\_\_\_\_

Dealer Inquiries Invited

# Software Discounters of America (& Peripherals, too!)

Orders Outside PA—1-800-225-7638

PA Orders — 1-800-223-7784

Customer Service 412-361-5291

- Free Shipping on orders over \$100 in continental USA
- No surcharge for VISA/Mastercard
- Your card is not charged until we ship



<b>ARTWORX</b> Bridge 4.0 ..... \$16 Strip Poker ..... \$19 Male Data Disk ..... \$16 Female Data Disk ..... \$16	<b>EPYX</b> Impossible Mission ..... \$23 Pitstop II ..... \$25 Summer Games ..... \$25 Temple of Apshai ..... \$19	Peanuts Maze Marathon ..... \$25 Snoopy's Reading Machine ..... \$25
<b>AVALON HILL</b> Beast War ..... \$19 B-1 Nuclear Bomber ..... \$16 Computer Stocks & Bonds ..... \$19 Legionnaire ..... \$21 T.A.C. .... \$26 Teleguard ..... \$19 Tournament Golf ..... \$21	<b>FISHER PRICE</b> Alpha Build ..... \$16 Logic Levels ..... \$16 Up & Add Em ..... \$16	<b>SCARBOROUGH</b> Boston Computer Diet \$49 Build A Book ..... \$26 Masterytype ..... \$25 Masterytype (MAC) ..... \$29 Make Millions (MAC) ..... \$32 Net Worth ..... \$49 Run for the Money (MAC) ..... \$29
<b>BLUE CHIP</b> Baron ..... \$32 Millionaire ..... \$32 Tycoon ..... \$32 These Titles Available for MAC ..... \$37 Ea	<b>HAYDEN</b> Ensemble (MAC) ..... \$179 Musicworks (MAC) ..... \$49 SAT (MAC) ..... \$65 Sargon II ..... \$16 Sargon III ..... \$32 Sargon III(MAC) ..... \$32 Word Challenge II (MAC) ..... \$25	<b>SIERRA ON LINE</b> Homeward ..... \$43 Homeward w/ Speller \$67 Kings Quest (128K) ..... \$33 Ultima II ..... \$39 Ultima II (MAC) ..... \$39
<b>BRODERBUND</b> Bank St. Filer (64K) ..... \$43 Bank St. Filer (128K) ..... \$43 Bank St. Mailer (64K) ..... \$43 Bank St. Mailer (128K) ..... \$43 Bank St. Speller ..... \$43 Bank St. Writer (64K) ..... \$43 Bank St. Writer (128K) ..... \$43 Capt. Goodnite ..... \$23 Carmen Sandiego ..... \$25 Cyborg (MAC) ..... \$25 Dazzle Draw (128K) ..... \$39 Karateka ..... \$23 Print Shop ..... \$33 Print Shop Graphics Library ..... \$19 Print Shop Paper Refill ..... Call Science Tool Kit ..... \$39	<b>INFOCOM</b> Cut Throats ..... \$25 Deadline ..... \$33 Enchanter ..... \$25 Hitchhiker's Guide to the Galaxy ..... \$25 Infidel ..... \$29 Planetfall ..... \$25 Sorcerer ..... \$29 Suspect ..... \$29 Wishbringer ..... \$25 Witness ..... \$25 Zork I ..... \$25 Zork II or III ..... \$29 * All titles available for Macintosh at prices listed above	<b>SIMON &amp; SCHUSTER</b> Gonzo in Wordrider ..... \$23 Kermit's Electronic Storymaker ..... \$23 NY Times Crossword Puzzles 1 ..... \$16 NY Times Crossword Puzzles 2 ..... \$16 Typing Tutor III ..... \$32 Typing Tutor III (MAC) ..... \$37
<b>CBS</b> Adventure Master ..... \$29 Algebra Series ..... Call America Coast to Coast ..... \$25 Charles Goren Bridge \$49 Dinosaur Dig ..... \$25 Dr. Seuss ..... \$21 Felony ..... \$21 Felony (MAC) ..... Call Mastering the SAT ..... \$67 Math Series ..... Call Micro Speed Read ..... \$65 Murder by Dozen ..... \$23 Sea Voyagers ..... \$25	<b>KOALA</b> Gibson Light Pen ..... \$149 Muppet Learning Keys (Ile & Ilc) ..... \$49 MacVision ..... \$229 Tablet w/ Painter (Ilc) \$75	<b>SPINNAKER</b> Alphabet Zoo ..... \$19 Counting Parade ..... \$19 Facemaker ..... \$17 Fraction Fever ..... \$17 Kidwriter ..... \$19 Kids on Keys ..... \$17 Kinder Comp ..... \$17 Story Machine ..... \$17 Trains ..... \$19
<b>CONTINENTAL</b> Book of Adv. Games ..... \$16 Home Accountant ..... \$44 Home Accountant (128 K Ile & Ilc) ..... \$44 Home Accountant (MAC) ..... \$59	<b>LEARNING COMPANY</b> Addition Magician ..... \$23 Gertrudes Secrets ..... \$25 Juggles Rainbow ..... \$19 Number Stumper ..... \$25 Reader Rabbit ..... \$25 Robot Odyssey I ..... \$33 Word Spinner ..... \$23	<b>SPRINGBOARD</b> Early Games ..... \$23 Easy as ABC ..... \$25 Fraction Factory ..... \$19 Mask Parade ..... \$25 Newsroom ..... \$33 Newsroom Click Art Template ..... \$19 Stickers ..... \$23
<b>DATASOFT</b> Bruce Lee ..... \$23 Conan ..... \$25 Dallas Quest ..... \$21 Pac Man ..... \$17	<b>MICROLAB</b> Death in Caribbean ..... \$23 Dino Eggs ..... \$16 Short Circuit ..... \$16	<b>SSI</b> Battle Normandy ..... \$25 Carrier Force ..... \$39 Computer Ambush ..... \$39 Computer Baseball ..... \$25 Computer QB ..... \$25 Galactic Adventures ..... \$39 Gemstone Warrior ..... \$23 Germany 1985 ..... \$39 Kampfgruppe ..... \$39 Phantasie ..... \$25 Pro Tour Golf ..... \$25 Questron ..... \$33 Rails West ..... \$25 War in Russia ..... \$49
<b>DAVIDSON</b> Math Blaster ..... \$33 Speed Reader II ..... \$43 Spell It ..... \$33 Word Attack ..... \$33	<b>MINDSCAPE</b> Bank St. Story Book ..... \$26 Crossword Magic ..... \$33 Mr. Pixel's Cartoon Kit \$23 Mr. Pixel's Programming Paint Set ..... \$23	<b>SUBLOGIC</b> Flight Simulator II ..... \$32
<b>ELECTRONIC ARTS</b> Archon II ..... \$27 Cut & Paste WP ..... \$29 Financial Cookbook ..... \$35 Financial Cookbook (MAC) ..... Call Music Construction Set ..... \$27 One-on-One ..... \$27 Pinball Construction Set ..... \$23 Seven Cities of Gold ..... \$27 Skyfox ..... \$27	<b>MONOGRAM</b> Dollars & Sense ..... \$59 Dollars & Sense (Ilc) ..... \$74 Dollars & Sense (MAC) \$95	<b>TELARIUM</b> Amazon ..... \$25 Fahrenheit 451 ..... \$25 Rendezvous w/Rama ..... \$25
	<b>MUSE</b> Beyond Wolfenstein ..... \$23 Castle Wolfenstein ..... \$19	<b>TIMEWORKS</b> Evelyn Wood Dynamic Reader ..... \$44
	<b>ORIGIN</b> Ultima III ..... \$39	<b>ACCESSORIES</b> BASF SS, DD ..... \$12 Bx BASF DS, DD ..... \$17 Bx Compuserve Starter kit (5hrs) ..... \$23, \$2/39 Disk Case (Holds 50) ..... \$9 Disk Drive Cleaner ..... \$9 Dow Jones Retrieval Kit (5hrs) ..... \$21 Super Serial Card ..... Call Total 300 Baud Modem W/ASCII Express ..... \$79
	<b>PRACTICORP</b> Practicalc II ..... \$35	
	<b>PROFESSIONAL SOFTWARE</b> Trivia Fever ..... \$25 Trivia Fever (MAC) ..... \$25 Trivia Fever Super Sports ..... \$19	
	<b>RANDOM HOUSE</b> Charlie Brown's ABC's ..... \$25	

P.O. BOX 278-DEPT AP-WILDWOOD, PA 15091

\*Ordering and Terms: Orders with cashier check or money order shipped immediately. Personal/company checks, allow 3 weeks clearance. No C.O.D.'s.  
Shipping: Continental U.S.A.—Orders under \$100 add \$3; free shipping on orders over \$100. PA residents add 6% sales tax. AK, HI, FPO-APO—add \$5 on all orders. Sorry—no International orders. Defective merchandise will be replaced with same merchandise. Other returns subject to a 15% restocking charge—NO CREDITS! Return must have authorization number (412) 361-5291. Prices subject to change without notice.

CIRCLE 155 ON READER SERVICE CARD

The descriptions of PBITS and PBITS+1 apply when the corresponding bit is set to 1. For example, if the command allows a pathname and A and E parameters, the handler will set PBITS to \$01 and PBITS+1 to \$A0. If a pathname is actually mandatory, bit 2 of PBITS+1 (the S and D bit) must be set to 1 as well. If BASIC.SYSTEM is not to do any parsing, PBITS must be set to 0.

After the handler sets up PBITS and PBITS+1, it stores the length of the command string minus 1 in XLEN (\$BE52), stores 0 (the code number for an external command) in XCNUM (\$BE53), and then stores at XTRNADDR (\$BE50/\$BE51) the address to which control is to pass after BASIC.SYSTEM parses the command line. The latter step must occur even if the handler has indicated that no parsing is necessary. Last, the handler must clear the carry flag before returning control to BASIC.SYSTEM.

When BASIC.SYSTEM regains control, the parameters in the command line are parsed in accordance with the encoded instructions stored in PBITS and PBITS+1. The values of the parameters that are actually parsed from the line are stored in a parameter table located at \$BE58-\$BE6F (see figure 2). If the handler does not detect a particular parameter during the parsing operation, the parameter's entry in the table stays as it was before the external command was executed. The actual parameters that were successfully parsed are indicated by the presence of "1" bits in FBITS (\$BE56) and FBITS+1 (\$BE57). The meaning of each bit in FBITS and FBITS+1 is the same as that of the corresponding bit in PBITS and PBITS+1.

After a successful parse, BASIC.SYSTEM jumps to the second half of the external-command handler, the subroutine whose address is stored at XTRNADDR (\$BE50/\$BE51). This subroutine can actually execute the command (if it wasn't already executed in the first half) and then return to BASIC.SYSTEM with the accumulator zeroed and the carry flag clear if there was no error.

If the handler detects an error, it then can be passed to BASIC.SYSTEM for handling by setting the carry flag and placing the appropriate error code in the accumulator. See Apple's *BASIC Programming with ProDOS* or my *Apple ProDOS, Advanced Features for Programmers* for a list of these error codes. Alternatively, the command handler can deal with the error itself; if it does, the handler must clear the carry flag and zero the accumulator before returning to BASIC.SYSTEM.

## A SAMPLE PROGRAM

Confused? Let's clear things up by examining the assembly-language program in figure 3. This program installs the handler for a command called DUMP# that you can use to send the contents of the 40- or 80-column video screen of the Apple IIe or IIc to a printer. (If you don't know how to deal with assembly-language programs, you can run the Applesoft program in figure 4 to install the DUMP# command.) You invoke the command by entering DUMP# snum from the Applesoft command mode (where snum represents the slot number of the printer) or by executing an Applesoft statement of this form:

```
100 PRINT CHR$(4); "DUMP#snun"
```

The first part of the program simply installs the new command handler by moving the current target address of the EXTRNCMD jump instruction to DAISY and DAISY+1 and replacing it with the address of CMDCODE. If

# APPLIED ENGINEERING

## To a World of Compromise, We Make No Contribution

### THE NEW TIMEMASTER II H.O.

- Absolutely, positively, totally PRO-DOS and DOS 3.3 compatible.
- Time in hours, minutes, seconds and milliseconds (the ONLY PRO-DOS compatible card with millisecond compatibility).
- 24 hour military format or 12 hour with AM/PM format.
- Date with year, month, day of week and leap year.
- Eight software controlled interrupts so you can run two programs at the same time (many examples are included).
- The only card recognized by both the

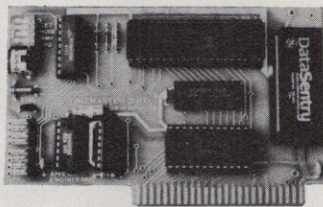

- DOS 3.3 and PRO-DOS versions of Apple Writer IIe.
- Appleworks will now time and date stamp all your data automatically.
- Compatible with ALL of Apple's languages. Many sample programs for machine code, Applesoft, CP/M and Pascal on 2 disks.
- On-board timer lets you time any interval up to 48 days long down to the nearest millisecond.
- Rechargeable nickel-cadmium battery will last over 20 years.
- Two BSR/serial ports for future expansion.

	PRO-DOS COMPATIBLE	INCLUDES DOS DATER	MILLISECOND TIME	YEAR DATA	LARGEST SAMPLE SOFTWARE	REMOTE SET PORT	BSR PORT	EMULATES ALL OTHER CLOCKS
H.O.	YES	YES	YES	YES	YES	YES	YES	YES
BRAND A	NO	NO	YES	NO	NO	NO	NO	NO
BRAND C	NO	NO	NO	NO	NO	NO	NO	NO
BRAND M	NO	NO	NO	NO	NO	NO	NO	NO
BRAND P	YES	YES	NO	YES	NO	NO	NO	NO
BRAND S	NO	NO	NO	YES	NO	NO	NO	NO
BRAND T	YES	NO	NO	NO	NO	NO	YES	NO

Full emulation of all other clocks. Yes, we emulate Brand A, Brand T, Brand P, Brand C, Brand S and Brand M too. It's easy for the H.O. to emulate other clocks, we just drop off features. That's why the H.O. can emulate others, but none of the others emulate us. The Timemaster II H.O. will automatically emulate the correct clock card for the software you're using. You can also give the H.O. a simple command to tell it which clock to emulate. This is great for writing programs for those poor unfortunates who bought some other clock card.

#### REMOTE CONTROL

Our BSR X-10 interface option for the H.O. allows you to remotely control up to 16 lights and electrical appliances through your BSR X-10 home control system in your home or office. You're already wired because a BSR system sends its signals over regular 120 volt wiring. That means you can control any electrical device in your home or office without additional wiring.

PRICE \$129.00 BSR Option (may be added later) \$49.00

### VIEWMASTER 80

There used to be about a dozen 80 column cards for the Apple. Now there is only ONE.

- TOTALLY Videx Compatible.
- 80 characters by 24 lines, with a sharp 7x9 dot matrix.
- On-board 40/80 soft video switch with manual 40 column override.
- Fully compatible with ALL Apple languages and software—there are NO exceptions.
- Low power consumption through the use of CMOS devices.
- All connections are made with standard video connectors.
- Both upper and lower characters are standard.
- All new design (using a new Microprocessor based C.R.T. controller) for a beautiful razor sharp display.
- The VIEWMASTER incorporates all the features of all other 80 column cards, plus many new improvements.

	PRICE	BUILT-IN SOFTSWITCH	SHIFT KEY SUPPORT	LOW POWER 80 COLUMN DESIGN	HOME	79 DOT MATRIX	LIGHT PEN INPUTS	40 COLUMN OVERRIDE	INVERSE CHARACTERS
VIEWMASTER	139	YES	YES	YES	YES	YES	YES	YES	YES
SLP/PTERM	MORE	NO	YES	NO	NO	NO	NO	YES	YES
WIZARD 80	MORE	NO	NO	NO	NO	YES	NO	YES	YES
VISION 80	MORE	YES	NO	NO	NO	YES	NO	NO	NO
OMNIVISION	MORE	NO	NO	NO	NO	NO	NO	YES	YES
VIEWMAX 80	MORE	YES	NO	NO	NO	YES	NO	YES	NO
SMARTERM	MORE	YES	YES	NO	NO	NO	YES	NO	NO
VIDEX	MORE	NO	YES	YES	NO	NO	YES	NO	YES

The VIEWMASTER 80 works with all 80 column applications including CP/M, Pascal, WordStar, Format II, Easywriter, Apple Writer II, VisiCalc, and all others. The VIEWMASTER 80 is THE MOST compatible 80 column card you can buy at ANY price!

PRICE \$139.00

### Z-80 PLUS

Now Includes New 4.0™ Software

Enter the CP/M world with the new Z-80 Plus card from Applied Engineering and introduce your Apple to thousands of new programs. Only the Z-80 Plus comes standard with the new 4.0 software, the most advanced system for running CP/M programs ever. Only CP/AM 4.0™ has advanced features like built-in disk emulation for popular memory expansion boards (those made by Apple and Applied Engineering and others) to give you a faster system with more storage. You also get menu driven utilities that are much easier to use than the older CP/M utilities so you can get down to all that great CP/M software faster. If you already own the Z-80 Plus, you can upgrade to the 4.0 software for only \$29. The Z-80 Plus runs older CP/M programs too, down to Version 1.6 (2.2 is the most popular). With the Z-80 Plus you can run the largest body of software in existence. Simply plug the Z-80 Plus into any slot in your Apple. You'll have two computers in one and the advantages of both, all at an unbelievably low price.

- TOTALLY compatible with ALL CP/M software.
- The only Z-80 card with a special 2K "CP/M detector" chip.
- Fully compatible with microsoft disks (no pre-boot required).
- Specifically designed for high speed operation in the Apple IIe (runs just as fast in the II+ and Franklin).
- Runs WORD STAR, dBASE II, TURBO PASCAL, FORTRAN-80, PEACHTREE and ALL other CP/M software with no pre-boot.
- A semi-custom I.C. and low parts count allows the Z-80 Plus to fly thru CP/M programs at a very low power level. (We use the Z-80A at a fast 4MHZ.)
- Does EVERYTHING the other Z-80 boards do, plus Z-80 interrupts.

PRICE \$139.00

### SUPER MUSIC SYNTHESIZER — END MOCKINGBOREDOM

- Complete 16 voice stereo music synthesizer on one card. Just plug it into your Apple, connect the audio cable (supplied) to your stereo, boot the disk supplied and you are ready to input and play songs.
- It's easy to program music with our compose software. You will start right away by inputting your favorite songs. The Hi-Res screen shows what you have entered in standard sheet music format.
- Now with new improved software for the easiest and the fastest music input system available anywhere.
- We gives you lots of software. In addition to Compose and Play

- programs, 2 disks are filled with over 30 songs ready to play.
- Easy to program in Basic to generate complex sound effects. Now your games can have explosions, phaser zaps, train whistles, death cries. You name it, this card can do it.
- Four white noise generators which are great for sound effects.
- Full control of attack, volume, decay, sustain and release.
- Our card will play notes from 30HZ to beyond human hearing.
- Automatic shutoff on power-up or if reset is pushed.
- Many many more features.
- Works in any slot of a IIe or II+ including slot 3 of a IIe.

PRICE \$159.00

Our boards are far superior to most of the consumer electronics made today. All I.C.'s are in high quality sockets with mil-spec. components used throughout. P.C. boards are glass-epoxy with gold contacts. Made in America to be the best in the world. All products work in Apple IIe, II, II+ and Franklin. Applied Engineering also manufactures a full line of data acquisition and control products for the Apple; A/D converters and digital I/O cards, etc. Please call for more information. All our products are fully tested with complete documentation and available for immediate delivery. All products are guaranteed with a no hassle **THREE YEAR WARRANTY.**



Call (214) 492-2027, 9 a.m. to 11 p.m. 7 days a week or send check or money order to P.O. Box 798, Carrollton, Texas 75006. MasterCard, Visa and C.O.D. welcome. No extra charge for credit cards. Texas residents add 5% sales tax. Add \$10.00 if outside U.S.A.

# COMPUTER NETWORK

CALL OUR TOLL FREE NUMBER

**800-621-0937**



NM RESIDENTS  
(505) 887-1492



3204 NATIONAL PARKS HWY, CARLSBAD, NM 88220

## BUSINESS

BPI G/A, A/R, A/P (//e only).....(ea)	\$267.00
ENSEMBEL (MAC).....	229.95
GRAPHWORKS.....	55.95
HABA MERGE.....	48.50
MEGAWORKS.....	85.00
PEACHTREE G/L, A/R, A/P.....	134.99
PFS FILE & REPORT.....(ea)	73.50
PFS FILE & REPORT (MAC).....	115.00
SIDEWAYS (Dos/Pro).....	35.95
QUARTET (MAC).....	CALL

## \*APPLIED ENGINEERING\*

Z80 PLUS (4.0 CP/M).....	\$125.95
Z80C (CP/M FOR //c).....	135.95
Z-RAM (//c MEMORY EXP-CP/M)	
256K...379.95	512K...549.95
RAM WORKS //E - 80 col/Memory Expansion card	
64K.....149.95	128K...189.95
256K...295.95	512K...415.95
APPLEWORKS MEMORY EXP.....	24.95
Expands Appleworks memory when used w/above cards.	

## EDUCATION

ALGEBRA 1, 2, 3, 4.....(ea)	\$ 24.50
EARLY GAMES YOUNG/CHILD.....	20.97
MASTERTYPE (IMPROVED).....	24.50
MATHBLASTER.....	30.50
SPELL-IT.....	30.50
STORY MAKER.....	21.50
TYPING TUTOR III.....	30.50
WORDATTACK.....	30.50

## WORD PROCESSING

BANK STREET FILER.....	\$ 42.50
BANK STREET SPELLER.....	42.50
BANK STREET WRITER.....	42.59
PFS WRITE (//e, //c).....	73.50
SENSIBLE SPELLER (Dos/Pro).....(ea)	73.50

## HOMEHOBBY

COPY II (//, MAC).....	\$ 25.95
BEYOND CASTLE WOLFENSTEIN.....	26.95
CHAMPIONSHIP LODERUNNER.....	21.95
CUTTHROATS.....	24.95
DAZZLE DRAW.....	36.95
DEADLINE.....	31.00
DR. J & LARRY BIRD 1-ON-1.....	26.95
EXODUS:ULTIMA III.....	36.50
FLIGHT SIMULATOR II.....	31.95
HITCHHIKERS GUIDE.....	24.50
HOME ACCOUNTANT (//+, //e/c).....	45.50
KARATEKA.....	26.95
MILLIONAIRE.....	30.50
NEWSROOM.....	34.95
PRINT SHOP.....	30.50
PRINT SHOP GRAPHICS LIB #1.....	16.50
SARGON III (//, MAC).....	30.50
SKYFOX.....	26.95
SUPER ZAXXON.....	25.95
ZORK I.....	24.90
ZORK II/III.....(ea)	27.50

## HARDWARE

AMDEK 600 RGB.....	\$420.00
AMDEK COLOR 300.....	240.00
CORVUS HARD DISK.....	CALL
DUMPLING GX INTERFACE.....	75.00
MCT SPEEDEMON.....	220.00
RGB INTERFACE DVM II/III.....	127.00
QUARK HARD DISK (//e, //c, Mac)	CALL

## PRINTERS

C.ITOH A10-20 L/Q.....	\$549.00
C.ITOH F10-40 L/Q.....	869.00
C.ITOH 8510 AP+.....(NEW)	349.00
EPSON LQ 1500.....	960.00
EPSON RX80 F/T.....	275.00
EPSON FX100.....	560.00
EPSON FX80.....	370.00
EPSON JX80.....	615.00

## DISKETTES

ELEPHANT DISKS DDDS.....	\$ 19.95
ELEPHANT DISKS SDSS.....	14.00
VERBATIM DISKS DDDS.....	24.00
VERBATIM DISKS DDSS.....	17.95
VERBATIM HEAD CLEANER.....	8.00
VERBATIM 3 1/2 DISK.....	28.95

\*\*\*\*\*

For fast delivery send cashier's check, certified check or money order. Personal and company checks allow 3 weeks to clear. Shipping - Software (\$2.50 min.) C.O.D. add an additional \$1.75. Shipping - Hardware (please call). Mastercard & Visa - 3% (include card # and expiration date). NM residents add 4.75% sales tax. Prices & availability subject to change without notice. Not Responsible for typographical errors. Apple is a registered trademark of Apple Computer.

Figure 3: The assembly-language program that defines and installs the DUMP# command.

```

1 *****
2 * BASIC.SYSTEM "DUMP#" command *
3 *
4 * DUMP# snum
5 *
6 * snum = printer slot # (0..7)
7 *
8 * Copyright 1985 Gary B. Little
9 *****
10
11 BASL EQU $28 ;Line base address pointer
12
13 CSW EQU $36 ;Output link
14 IN EQU $200 ;Command input buffer
15
16 EXTRNCMD EQU $BE06 ;External command JMP instr
17 XTRNADDR EQU $BE50 ;Start of external cmd handler
18 XLEN EQU $BE52 ;External cmd name length (-1)
19 XCNUM EQU $BE53 ;Command # (0 for external)
20 PBITS EQU $BE54 ;Command parameter bits
21 SLPARM EQU $BE6B ;"snum" parameter value
22
23 COL80 EQU $C01F ;bit 7=1 if 80-columns on
24 MAINRAM EQU $C054 ;Select main video page
25 AUXRAM EQU $C055 ;Select auxiliary video page
26
27 IDBYTE EQU $FBB3 ;ID: 6=Apple //e, //c
28 BASCALC EQU $FBC1 ;Calculate screen base address
29 CROUT EQU $FD8E ;Print a CR
30 COUT EQU $FDED ;Std. character output sub.
31 OUTPORT EQU $FE95 ;Monitor "PR#" command
32
33 ORG $2E9
34
35 * Install the new command handler:
36
37 02E9: AD 07 BE LDA EXTRNCMD+1 ;Set up daisy chain to
38 02EC: 8D B1 03 STA DAISY ; existing external command.
39 02EF: AD 08 BE LDA EXTRNCMD+2
40 02F2: 8D B2 03 STA DAISY+1
41
42 02F5: A9 00 LDA #<CMDCODE ;Install the external command
43 02F7: 8D 07 BE STA EXTRNCMD+1 ; handler by storing its addr
44 02FA: A9 03 LDA #>CMDCODE ; after the JMP at EXTRNCMD.
45 02FC: 8D 08 BE STA EXTRNCMD+2
46
47 02FF: 60 RTS
48
49 *****
50 * Check for presence of command. *
51 *****
52 CMDCODE CLD ;Identification byte
53 LDY #0
54 LDX #0
55 CHKCMD LDA IN,X ;Get command character
56 INX
57 CMP #SA0 ;Is it a blank?
58 BEQ CHKCMD ;If it is, ignore it
59 CMP CMDNAME,Y ;Same as our command?
60 BEQ CHKCMD1 ;Yes, so branch
61 CMP #SE0 ;Lower case?
62 BCC NOTFOUND ;No, so branch
63 AND #SDF ;Convert to uppercase
64 CMP CMDNAME,Y ;OK now?
65 BNE NOTFOUND ;No, so branch
66 CHKCMD1 INY
67 CPY #CMDLEN-CMDNAME ;At end?
68 BNE CHKCMD ;No, so branch
69 BEQ SETRULES ;Yes, so branch
70
71 NOTFOUND SEC ;Set carry to indicate failure
72 JMP (DAISY) ;Try next user command
73
74 SETRULES DEY
75 STY XLEN ;Store command length-1
76
77 LDA #<EXECUTE ;Put address of command handler
78 STA XTRNADDR ; into XTRNADDR.
79 LDA #>EXECUTE
80 STA XTRNADDR+1
81
82 LDA #0
83 STA XCNUM ;External cmd number = 0
84
85 LDA #S40 ;"snum" mandatory
86 STA PBITS
87 LDA #0
88 STA PBITS+1
89

```



```

0345: 18      90      CLC          ;Clear carry to indicate success
0346: 60      91      RTS
          92
          93 * BASIC.SYSTEM comes here after it has
          94 * successfully parsed the command line:
          95
0347: 08      96      EXECUTE PHP      ;Save interrupt status
0348: 78      97      SEI          ;Disable interrupts for this
          98
0349: A5 36   99      LDA CSW      ;Save current output hook
034B: 48      100     PHA          ; on the stack.
034C: A5 37   101     LDA CSW+1
034E: 48      102     PHA
034F: A5 28   103     LDA BASL     ;Save current base address
0351: 48      104     PHA
0352: A5 29   105     LDA BASL+1
0354: 48      106     PHA
          107
0355: AD 6B BE 108     LDA SLPARM   ;Get printer slot #
0358: 20 95 FE 109     JSR OUTPORT  ;Do a "PR# snum"
          110
          111 * Turn off screen echo:
          112
035B: A2 00   113     LDX #0
035D: BD B3 03 114     INITPRT LDA NOECHO,X ;Get printer byte
0360: F0 06   115     BEQ DUMPSCR ;Branch if done
0362: 20 ED FD 116     JSR COUT     ;..else send to printer
0365: E8      117     INX          ;On to the next one
0366: D0 F5   118     BNE INITPRT ;(Always taken)
          119
0368: A9 00   120     DUMPSCR LDA #0
036A: 8D B8 03 121     STA LINENUM ;Start with line 0
          122
036D: 20 C1 FB 123     GETBASE JSR BASCALC ;Get base address for line
          124
0370: A0 00   125     LDY #0
0372: 2C 1F C0 126     PRTLINE BIT COL80   ;80-columns on?
0375: 10 12   127     BPL PL1     ;No, so branch
0377: AD B3 FB 128     LDA IDBYTE   ;Apple //e or //c?
037A: C9 06   129     CMP #6
037C: D0 0B   130     BNE PL1     ;No, so branch
037E: 8D 55 C0 131     STA AUXRAM   ;Read even column
0381: B1 28   132     LDA (BASL),Y ;Get byte
0383: 8D 54 C0 133     STA MAINRAM  ;Get ready for odd column
0386: 20 ED FD 134     JSR COUT     ;Print even column
0389: B1 28   135     PL1 LDA (BASL),Y
038B: 20 ED FD 136     JSR COUT
038E: C8      137     INY
038F: C0 28   138     CPY #40     ;At end of line?
0391: D0 DF   139     BNE PRTLINE ;No, so branch
          140
0393: 20 8E FD 141     JSR CROUT
          142
0396: EE B8 03 143     INC LINENUM  ;Move to next line
0399: AD B8 03 144     LDA LINENUM
039C: C9 18   145     CMP #24     ;Past the bottom?
039E: D0 CD   146     BNE GETBASE ;No, so branch
          147
03A0: 68      148     PLA          ;Restore base address
03A1: 85 29   149     STA BASL+1
03A3: 68      150     PLA
03A4: 85 28   151     STA BASL
          152
03A6: 68      153     PLA          ;Restore output hook
03A7: 85 37   154     STA CSW+1   ; from the stack.
03A9: 68      155     PLA
03AA: 85 36   156     STA CSW
          157
03AC: 28      158     PLP          ;Restore interrupt status
          159
03AD: 18      160     CLC          ;Clear error flag
03AE: A9 00   161     LDA #0      ;Clear error code
03B0: 60      162     RTS
          163
03B1: 00 00   164     DAISY DA $0000 ;Address of next cmd handler
          165
          166 *****
          167 * Command to turn off screen echo. *
          168 *****
03B3: 89      169     NOECHO DFB $89   ;CTRL-I
03B4: B8 B0 CE 170     ASC "80N"
03B7: 00      171     DFB 0       ;(terminator)
          172
03B8: 00      173     LINENUM DS 1
          174
03B9: C4 D5 CD 175     CMDNAME ASC "DUMP#" ;External command name
03BC: D0 A3   176     CMDLEN EQU *

```

**REMEMBER!**  
**Always**  
**be**  
**prepared**  
**whenever**  
**you**  
**enter the**  
**adventure-**  
**filled world**  
**of...**

**EAMON**



**Six different text-adventures  
for the Apple.  
All for only \$20.00!**

Please send me the EAMON Introductory Offer. I have enclosed \$20.00 plus applicable sales tax, shipping & handling. I understand that Public Domain Software is not commercial quality and is supplied as-is and that orders are filled on double-sided disks.

Name \_\_\_\_\_ \$-2 \_\_\_\_\_  
Address \_\_\_\_\_  
City \_\_\_\_\_ State \_\_\_\_\_ Zip \_\_\_\_\_  
Country \_\_\_\_\_ Phone \_\_\_\_\_  
VISA/MC \_\_\_\_\_ Exp \_\_\_\_\_

Signature \_\_\_\_\_  
Send check or money order (US funds drawn on US bank) to: Computer Learning Center, PO Box 110876-A, Tacoma, WA 98411. Washington residents add 7.8% sales tax. Foreign orders add 20% shipping and handling.

# DIGITAL VISION

## COMPUTEREYES™

### VIDEO IMAGES ON YOUR COMPUTER!

Finally—an inexpensive way to capture real-world images on your computer's graphics display! COMPUTEREYES™ is an innovative slow-scan device that connects between any standard video source (video tape recorder, video camera, videodisk, etc.) and your computer. Under simple software control, a b/w image is acquired in less than six seconds. Unique multi-scan modes also provide realistic grey-scale images. Hundreds of applications!

Package includes interface module, complete easy-to-use software support on disk, owner's manual, and one year warranty all for \$129.95 plus \$4.00 S&H (USA).

Also available as a complete package including:

- COMPUTEREYES™
- Quality b/w video camera
- Connecting cable

for only \$399.95 plus \$9.00 S&H.

Demo disk available for \$10.00 postpaid (refundable).

See your dealer or order direct. Mass. residents add 5% sales tax. Mastercard, Visa accepted. To order, or for more information, write or call:



**ONLY \$129.95**

Available for:

- Apple II series
- Commodore 64/128
- Atari 800/800XL/65XE/130XE

**DIGITAL VISION, INC.**  
14 Oak Street — Suite 2  
Needham, MA 02192  
(617) 444-9040, 449-7160

CIRCLE 172 ON READER SERVICE CARD

## Professional Handicapping Systems



by Professor Jones

### GLD. Thoroughbred "Gold" Edition™

A "Full" featured Thoroughbred analysis designed for the professional and serious novice. **\$159.95** complete

### EGLD. Enhanced "Gold" Edition™

"Gold" Edition with complete Master Bettor™ system integrated onto the same disk. This powerful program will transfer all horses and scores to the bet analysis with a "single keystroke." (Master Bettor™ included) **\$199.95** complete

### GLTD. Limited "Gold"™

Enables Professional Handicappers to assign specific values to the racing variables "they" feel are important. Create program weight based on a particular track and fine tune it for maximum win percentage. This program is designed for "ease of use." The user needs no programming experience. (contains Integrated Bettor™) **\$299.95** complete

### GD. Gold Dog Analysis™

The only professional dog handicapper on the market, includes:

- 1) Speed
- 2) Post Today
- 3) Kennel
- 4) Post Last
- 5) Distance
- 6) Condition
- 7) Running Style
- 8) Weight
- 9) All new internal weighting
- 10) NEW class indicator

If you are near a greyhound track, you can't afford not to use this program. **\$149.95** complete (with integrated Master Bettor™) **\$199.95** Limited Dog™ **\$299.95**

### PPX. Professor Jones' Football Predictor, Prof. Pix™

Complete Football Analysis with Data-Base.

- 1) Overlays
- 2) Point Spreads
- 3) "Super Plays"
- 4) "Over/Under" bets
- 5) Data Base Stats
- 6) Holds "100" teams

Highest percentage of winners 1984  
**\$49.95** complete **\$99.95** with Data Base Management

### MHH. Master Harness Handicapper™

Professional software designed to provide a thorough analysis of all trotter and pacer races in North America and Canada. **\$159.95** complete with integrated Master Bettor™ **\$199.95**

### NBA. Basketball™

This data base managed analysis will provide the user with "ALL" betting situations while storing relevant information on the disk. **\$99.95** complete w/Manual **\$129.95** NBA/College Version

### LOT. LOTTERY ANALYSIS™

Statistical comparison program designed to detect subtle patterns in winning lottery number. **\$79.95** complete w/Manual **\$99.95** with Lotto

**BROCHURE AVAILABLE**

CIRCLE 148 ON READER SERVICE CARD

```

0 REM "DUMP#" INSTALLER
100 FOR I = 745 TO 957: READ X: POKE I,X: NEXT
200 CALL 745
300 END
1000 DATA 173,7,190,141,177,3,173,8,190,141,178,3,169,0,141,7,190,169,3,
141,8,190,96,216,160,0,162,0,189,0
1001 DATA 2,232,201,160,240,248,217,185,3,240,11,201,224,144,14,41,223,
217,185,3,208,7,200,192,5,208,227,240,4,56
1002 DATA 108,177,3,136,140,82,190,169,71,141,80,190,169,3,141,81,190,
169,0,141,83,190,169,64,141,84,190,169,0,141
1003 DATA 85,190,24,96,8,120,165,54,72,165,55,72,165,40,72,165,41,72,173,
107,190,32,149,254,162,0,189,179,3,240
1004 DATA 6,32,237,253,232,208,245,169,0,141,184,3,32,193,251,160,0,44,
31,192,16,18,173,179,251,201,6,208,11,141
1005 DATA 85,192,177,40,141,84,192,32,237,253,177,40,32,237,253,200,192,
40,208,223,32,142,253,238,184,3,173,184,3,201
1006 DATA 24,208,205,104,133,41,104,133,40,104,133,55,104,133,54,40,24,
169,0,96,0,0,137,184,176,206,0,0,196,213
1007 DATA 205,208,163
    
```

Figure 4: The Applesoft program that installs the DUMP# command

it's not our handler's command, things have been arranged so that control will always daisy-chain down to the previously installed command handler.

When BASIC.SYSTEM comes across an unrecognized command, it passes control to CMDCODE. The first thing CMDCODE does is check if the DUMP# character string is in the input buffer at \$200. If it isn't, the carry flag is set to indicate that the command was not handled, and control passes through to the subroutine whose address is stored at DAISY.

If CMDCODE does detect DUMP#, control passes to SETRULES, where the value of the length (minus 1) of the command string is stored at XLEN (\$BE52), the external-command number (0) is stored in XCNUM (\$BE53), and the address of the part of the handler that is to be called after parsing (EXECUTE) is stored at XTRNADDR and XTRNADDR+1 (\$BE50/\$BE51). The command handler then stores the parsing rule ("snum is required") in PBITS and PBITS+1 (\$BE54/\$BE55) by setting bit 6 of PBITS to 1. Finally, the carry flag clears to indicate that the command was successfully detected and parsing should begin. When the BASIC.SYSTEM parser takes over, it checks to see whether "snum" was specified. If it wasn't, or if any other parameter was detected, an error will occur. Otherwise, the value of "snum" is stored at SLPARM (\$BE6B), and the address of the subroutine stored at XTRNADDR (EXECUTE) is called.

EXECUTE contains the specific code necessary to send the characters on the screen to the printer, line by line. We won't get into the details of how it does this, since it really has nothing to do with ProDOS or BASIC.SYSTEM. The comments in the listing in figure 3 should clarify what is happening, however. You may also want to refer to books such as *Inside the Apple IIe*, *Inside the Apple IIc*, or Apple's reference manuals for descriptions of how the 40- and 80-column video screens are stored in memory.

After the screen has printed, the carry flag clears and the accumulator is zeroed to indicate that no error has occurred. Control then returns to BASIC.SYSTEM, and we're done!

Well, that does it for this month. Next time we'll take a close look at two system programs called FILER and CONVERT that you can use to perform various useful chores such as formatting disks, copying files, and transferring files between DOS 3.3 and ProDOS disks. +

Gary B. Little is a lawyer and author in Vancouver, British Columbia. He has written three books for programmers of the Apple II series: *Inside the Apple IIe*, *Inside the Apple IIc*, and *Apple ProDOS, Advanced Features for Programmers (1985, Brady Communications)*.

# 100% APPLE COMPATIBLE



**You've made your choice. Now you need an Apple magazine.  
A+ The #1 Apple Magazine.**

Every software package and peripheral...every professional, educational and recreational application...  
every article and tutorial...every book review and excerpt...in every monthly issue of A+ ...  
is completely compatible with Apple II Series and Macintosh computers.

To subscribe, call toll-free 800-852-5200 or use the attached order card  
and tell us how much you want to save on A+

Save 20% — 1 year only \$19.97

Save 26% — 2 years only \$36.97

Savings based on full one-year (12 issues) subscription price of \$24.97.

**A+** It's the right choice for every Apple user.

4Z155

# Big Game Hunting? Try Baggin' Our Dragon.

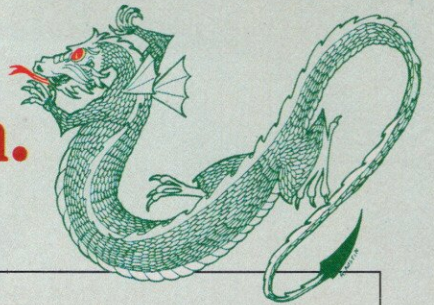

It's the biggest game in town

**O**ur dragon, of course, is Wizardry—that unique series of computer recreation programs designed for Apple users who are seeking the ultimate “big game” challenge.

Since its debut, Wizardry has been the best-selling computer game of its kind.

For a very good reason:

Because Wizardry is more than just a game, more than a diabolically clever maze.

Wizardry is a complex world of variety and depth. A world of richness and pleasure.

Packed with suspense, full of surprises, Wizardry is enchanting—a compelling

diversion that turns your leisure time into prime time.

Wizardry is powerful and sophisticated. A simple command system, 3D maze displays and superb programming provide you with month after month of involvement and satisfaction.

Four years old and still growing, the game is already recognized by critics and game lovers as a classic.

Simply stated, Wizardry is the finest fantasy role-playing computer game you can buy.

Set your sights on the best. Track down Wizardry—the biggest game in town.

## Enter the World of Wizardry®

A Classic Encounter

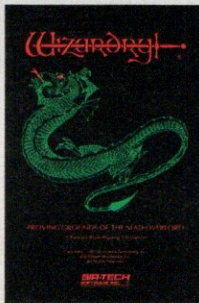

### Proving Grounds of the Mad Overlord

*The First Scenario*

Unlike any other game you have ever played. A fascinating 10-level maze full of monsters, sorcery, traps and treasures. As you gain skills, the characters you create grow stronger, richer, wiser and better able to survive. The final goal is elusive. Your experience... unforgettable.

Twice voted “All Time Most Popular Computer Program”  
—Softalk Readers

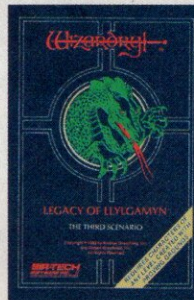

### Legacy of Llylgamyn

*The Third Scenario*

A spellbinder that advances the classic traditions of Wizardry. Find the great dragon Lkbreth and save the people of Llylgamyn. Includes full screen maze display and Windo-Wizardry, the revolutionary pop-up window graphics system. Requires brave adventurers of any level developed in PROVING GROUNDS.

“... A Landmark in Graphics Advancement” and “The Best Yet”  
—Softalk

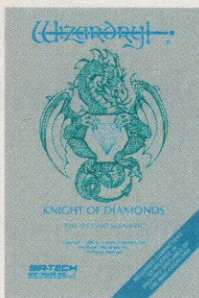

### Knight of Diamonds

*The Second Scenario*

This classic journey should only be attempted with those Wizardry heroes who have attained the 13th level of ability in PROVING GROUNDS. Their challenge—and yours—to adventure through a six-level maze and become the Knight of Diamonds. First-rate fantasy!

Awarded “Best Adventure Game for the Home Computer”  
—Game Mfrs. Association of America

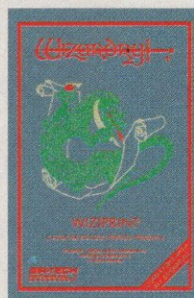

### Wiziprint

*Character Statistics Printout*

A helpful utility program that prints the possessions, attributes and known spells of all your Wizardry characters. Quick, neat and easy-to-read. For use with 80-column printers. Compatible with all Wizardry scenarios. A real timesaver!

“Wiziprint is a very handy utility disk for ardent Wizardry players”  
—Roe R. Adams III, Softalk

LOOK FOR THE DRAGON—  
SYMBOL OF WIZARDRY.  
PROMISE OF EXCELLENCE.

All software available for Apple II series computer 48k  
Coming soon for the Macintosh  
Proving Grounds also available for IBM PC and PCjr 64k

**SIR-TECH**  
SOFTWARE INC.

6 MAIN STREET • OGDENSBURG, N.Y. 13369 • (315) 393-6633

LEADERS IN COMPUTER FANTASY ROLE-PLAYING

CYBORG FOR THE MAC  
KARATEKA  
SOLO FLIGHT  
USADVENTURE

# THAT'S entertainment

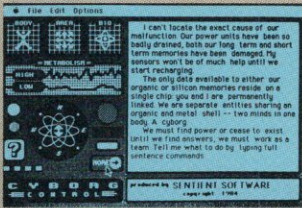

You are at a T in the road. There is a tiny lizard in a spacesuit leaning on an even tinier crutch. He is crying 'Truth for food.'

## SPLIT PERSONALITY

You awaken. The world around you is weird, surreal, sublime. You feel strange, changed, there is a murmuring in your head. You are not alone.

You start to remember. You volunteered . . . The surgeons have changed you. You are now a Cyborg, a creature of metal and muscle, steel and sinew. You don't know where you are or what you're supposed to be doing, but curiosity and hunger dictate that you must move.

You are at a T in the road. There is a tiny lizard in a spacesuit leaning on an even tinier crutch. He is crying, "Truth for food."

You have neither food nor truth. You are on your own, in a way, but now you have a constant companion. Your new partner, the metal half of yourself, which has damaged memory chips. It is about as comfortable with you as you are with it. You will have to come to terms and a mutually acceptable vocabulary.

I don't know about you, but I've had Mondays like that.

Welcome to the world of Cyborg, the adventure game by Sentient Software, published by Brøderbund Software. This is a true sci-fi/fantasy addict's game. Getting yourself dressed, armed, and permanently

powered are only a few of the goals you must meet. There are worlds within worlds, intelligent two-headed snakes with three arms, and doors that defy Newtonian physics.

That's the first level.

Believe it or not, it's fun, and the internal logic of Cyborg invites its own form of madness. Or addiction. You must discover what your purpose is in order to figure out what you must accomplish to complete the adventure.

I haven't beaten the game yet, and have not actually met anyone (including the folks at Brøderbund) who has. Cyborg gets

under your skin—when you're away from your machine, you find yourself discussing the finer points of laser power settings and lizard feeding. Strange, perhaps, but it beats soap operas by a wide margin.

The Macintosh version of Cyborg is easy to get around in. The screen is divided in half, the right portion dedicated to interactive dialogue with the environment and your Cyborg self. The left half of the screen is a hi-res control panel, a feature peculiar to the Brøderbund Mac edition of Cyborg. (Sentient Software, the creator of Cyborg, has released versions for

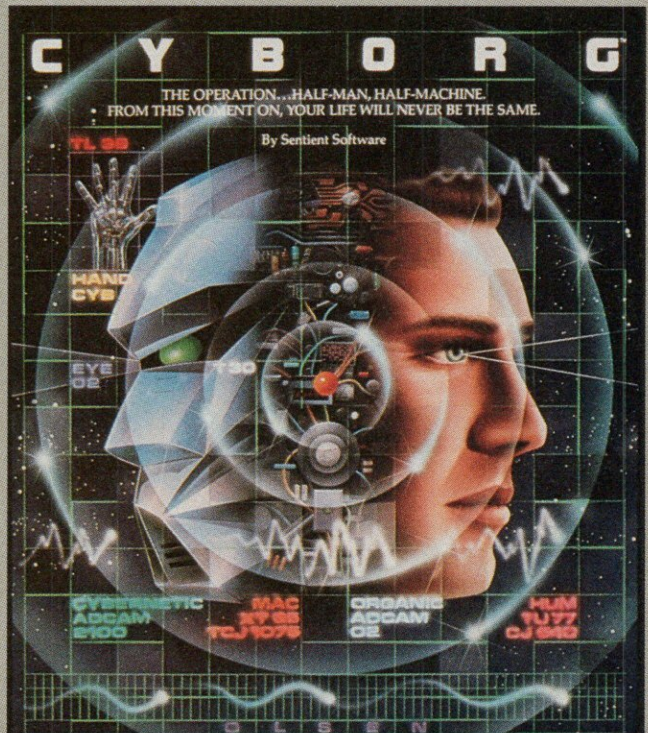



**It's easy to make a copy.  
It's quick.  
It's illegal.  
It's wrong.**

It's hard to believe.

People who wouldn't think of shoplifting a software product on their lunch hour don't think twice about going back to the office and making several illegal copies of the same software.

Making unauthorized copies of software is a violation of U.S. Copyright Law. Yet, the problem has reached epidemic proportions because many people are unaware, or simply choose to ignore the law. The software industry is urging decision-makers and software users to take steps to stop software piracy in their organizations. In the meantime, the industry has been forced to prosecute willful copyright violators.

There are legal, moral and economic imperatives forbidding theft of copyrighted software.

There is a free pamphlet on the subject. Call or write for a copy. A copy. A copy. A copy for everyone you know. Please ask for Priscilla.



ADAPSO  
1300 North Seventeenth Street  
Arlington, Virginia 22209  
(703) 522-5055

Commodore, Atari, and the Apple II series under its own name. Because of the limitations of these machines, these versions are entirely text games.)

The control panel relieves you from the drudge typing that plagues most adventure games—it has a compass rose, for instance, that you can click on to move in any direction, including up and down. Icon-driven Scan functions allow you to survey your personal inventory, environment, and metabolism. You use a question mark to find out your computerized half's opinions on the area and objects you are holding or encounter.

A word to the wise: Your Cyborg self has a sense of humor, and though it won't lie to you, it does make mistakes. It also has a nasty

habit of shutting itself off when you feel you need it most.

The control panel lets you save your key-pressing energy for more advanced activities such as taking and wearing stuff, shooting things, breaking down doors, and talking to trees (the trees do not answer, but in the world of Cyborg you can not ignore the possibility that they might).

The parser (the portion of the program that interprets English and drives the command structure of the game) is a little on the dim side. It recognizes about 800 words and has very strong feelings about what they mean. For example, it regards the difference between BREAK, OPEN, and CUT as large, and employing the wrong verb in the right place can lead you

to a premature demise.

The game has no dictionary. According to the Brøderbund people, finding out the Cyborg's vocabulary is half the fun. I tend to agree, although I got clobbered several times trying to talk to myself.

I really like this game. In a way, I dread the day when I actually master it. With any luck, Sentient will have come out with a new game by then.

*Ken Goehner*

**Cyborg for the Mac**  
Sentient Software  
Published by:  
Brøderbund Software  
17 Paul Drive  
San Rafael, CA  
94903-2101  
(415) 479-1170

**List Price:** \$39.95

**Requires:** Macintosh

**CIRCLE READER SERVICE NO. 362**

## THE KARATEKA KID

Welcome home, kid. While you were away studying karate, the evil warlord Akuma burned your village to the ground, stole your fiancée, and retired to his castle fortress. Now you must infiltrate the fortress,

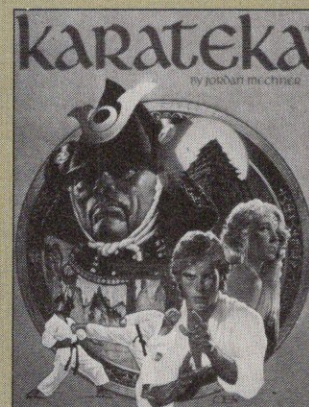

battle past the palace warriors, and KO Akuma to rescue your beloved.

# WARNING!

Some of Applied Engineering's Products are being sold by non-authorized dealers.

To insure your warranty, to receive upgrades and to obtain technical support, please buy direct from Applied Engineering or an authorized dealer.

Be suspicious if:

- 1) The dealer is mail order.
- 2) You don't know the dealer.
- 3) The product is not in stock.

If you're not sure about a dealer, please call us.

(214) 241-6060



APPLIED ENGINEERING  
"We Set the Standard"

Mindshadow. A Unique Challenge In Home Computer Software:

# You're One In 4,762,300,000. The Question Is Which One?

Amnesia. Complete and total. And very, very dangerous.

Who are you and why were you left on this isolated beach to perish? The search for your identity begins here, but before it ends you will travel the globe seeking clues.

You'll have to deal with intrigue, deceptions, reversals and unsavory characters to unravel the mystery of this "living novel."



Phil Wiswell, the respected syndicated columnist, in his review of our new illustrated text adventure said: "Mindshadow is... frightening, frustrating and completely absorbing. Brilliant!"

Look at it this way: There are only four billion seven hundred sixty-two million three hundred thousand possibilities.



*This challenging computer software is available for Apple II, Atari, Commodore 64, IBM PC and PCjr home computers.*

**ACTIVISION**  
HOME COMPUTER SOFTWARE



Such is the story behind Karateka, a game of martial-arts action for the Bruce Lee in all of us. Broderbund touts this game as a "suspenseful, movie-like story" with "realistic karate fighting" and

**Your beloved languishes in a dimly lit cell.**

"smoothly animated characters." I can agree with the advertising, but only on a two-dimensional plane.

The screen shows a side view of you and your opponent. In battle, you can move only left or right. You cannot circle around the warrior or perform somersaults or flips. Hence, your maneuvering is pretty much restricted to slugging it out

toe to toe in unarmed combat—perhaps a strategy for a heavyweight boxer, but not for a black belt.

Your offensive firepower consists of three kicks and three punches. Each warrior takes a certain number of hits before being pounded into unconsciousness. The challenge of Karateka lies in figuring out the fighting style of each warrior and then choosing the right combination of kicks and punches to send him into samurai slumberland.

The graphics are as smooth as the packaging promises. Your black-belted avenger, dressed in good-guy white, kicks and punches with grace, if not accuracy. Your beloved languishes in a dimly lit cell, waiting for her hero to rescue her. The enemy warriors, clad in bad-guy blue

and orange and sporting fearsome masks, advance with purpose. Each hit results in an orange or blue explosion, similar to the effect of comic-book blows.

The best sound effect is a resounding battle cry before and after each engagement. Your adrenalin really starts pumping when you defeat a particularly crafty opponent, strike a dramatic

pose, and then unleash a primeval yell.

You can rescue the princess without too much trouble, once you take the time to puzzle out the repetitious fighting style of each opposing warrior. Your most formidable foe is a savage blue falcon that is anything but the proverbial bluebird of happiness. Start kicking at the appropriate height

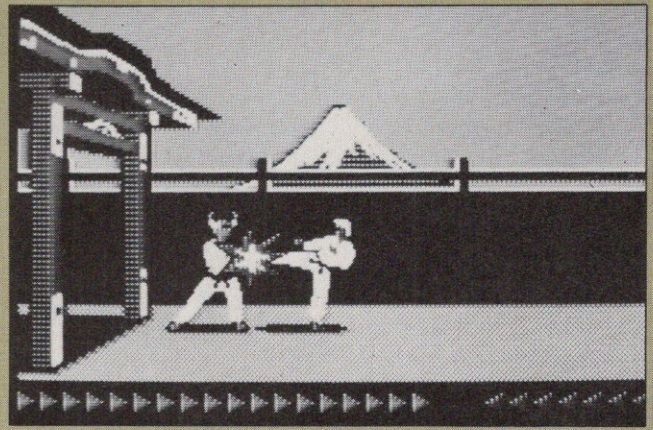

Now you can monitor and control the world (or at least your part of it) with a little help from  
**APPLIED ENGINEERING**

**12 BIT, 16 CHANNEL, PROGRAMMABLE GAIN A/D**

- All new 1984 design incorporates the latest in state-of-art I.C. technologies.
- Complete 12 bit A/D converter, with an accuracy of 0.02%!
- 16 single ended channels (single ended means that your signals are measured against the Apple's GND.) or 8 differential channels. Most all the signals you will measure are single ended.
- 9 software programmable full scale ranges, any of the 16 channels can have any range at any time. Under program control, you can select any of the following ranges:  $\pm 10$  volts,  $\pm 5V$ ,  $\pm 2.5V$ ,  $\pm 1.0V$ ,  $\pm 500MV$ ,  $\pm 250MV$ ,  $\pm 100MV$ ,  $\pm 50MV$ , or  $\pm 25MV$ .
- Very fast conversion (25 micro seconds).
- Analog input resistance greater than 1,000,000 ohms.
- Laser-trimmed scaling resistors.
- Low power consumption through the use of CMOS devices.
- The user connector has +12 and -12 volts on it so you can power your sensors.
- Only elementary programming is required to use the A/D.
- The entire system is in one standard size plug in card that fits neatly inside the Apple.
- System includes sample programs on disk.

**PRICE \$319**

A few applications may include the monitoring of ● flow ● temperature ● humidity ● wind speed ● wind direction ● light intensity ● pressure ● RPM ● soil moisture and many more.

**A/D & D/A**

**A/D & D/A Features:**

- Single PC card
- 8 channels A/D
- 8 channels D/A
- Superfast conversion time
- Very easy programming
- Many analog ranges
- Manual contains sample applications

**A/D SPECIFICATIONS**

- 0.3% accuracy
- On-board memory
- Fast conversion (.078 MS per channel)
- A/D process totally transparent to Apple (looks like memory)
- User programmable input ranges are 0 to 10 volts, 0 to 5, -5 to +5, -2.5 to +2.5, -5 to 0, -10 to 0.

The A/D process takes place on a continuous, channel sequencing basis. Data is automatically transferred to its proper location in the on-board RAM. No A/D converter could be easier to use.

**D/A SPECIFICATIONS**

- 0.3% accuracy
- On-board memory
- On-board output buffer amps can drive 5 MA
- D/A process is totally transparent to the Apple (just poke the data)
- Fast conversion (.003 MS per channel)
- User programmable output ranges are 0 to 5 volts and 0 to 10 volts

The D/A section contains 8 digital to analog converters, with output buffer amplifiers and all interface logic on a single card. On-card latches are provided for each of the eight D/A converters. No D/A converter could be easier to use. The on-board amplifiers are laser-trimmed during manufacture, thereby eliminating any requirement for off-set nulling.

**PRICE \$199**

**SIGNAL CONDITIONER**

Our 8 channel signal conditioner is designed for use with both our A/D converters. This board incorporates 8 F.E.T. op-amps, which allow almost any gain or offset. For example, an input signal that varies from 2.00 to 2.15 volts or a signal that varies from 0 to 50 mV can easily be converted to 0-10V output for the A/D.

The signal conditioner's outputs are on a high quality 16 pin gold I.C. socket that matches the one on the A/D's so a simple ribbon cable connects the two. The signal conditioner can be powered by your Apple or from an external supply.

**FEATURES**

- 4.5" square for standard card cage and 4 mounting holes for standard mounting. The signal conditioner does not plug into the Apple, it can be located up to 1/2 mile away from the A/D.
- 22 pin .156 spacing edge card input connector (extra connectors are easily available i.e. Radio Shack).
- Large bread board area.
- Full detailed schematic included.

**PRICE \$79**

**I/O 32**

- Provides 4, 8-Bit programmable I/O Ports
- Any of the 4 ports can be programmed as an input or an output port
- All I/O lines are TTL (0-5 volt) compatible

- Your inputs can be anything from high speed logic to simple switches
  - Programming is made very easy by powerful on-board firmware
  - The I/O 32 is your best choice for any control application
- The I/O manual includes many programs for inputs and outputs.

**Some applications include:**

Burglar alarm, direction sensing, use with relays to turn on lights, sound buzzers, start motors, control tape recorders and printers, use with digital joystick.

**PRICE \$89**

Please see our other full page ad in this magazine for information on Applied Engineering's Timemaster Clock Card and other products for the Apple. Our boards are far superior to most of the consumer electronics made today. All I.C.'s are in high quality sockets with mil-spec. components used throughout. P.C. boards are glass-epoxy with gold contacts. Made in America to be the best in the world. All products compatible with Apple II and IIe.

Applied Engineering's products are fully tested with complete documentation and available for immediate delivery. All products are guaranteed with a no hassle three year warranty.

Texas Residents Add 5% Sales Tax  
Add \$10.00 If Outside U.S.A.

Send Check or Money Order to:  
**APPLIED ENGINEERING**  
P.O. Box 798  
Carrollton, TX 75006

Call (214) 492-2027  
7 a.m. to 11 p.m. 7 days a week  
MasterCard, Visa & C.O.D. Welcome  
No extra charge for credit cards

when you see it appear on the screen.

The other fatal obstacle is a falling gate, underneath which you must never move. To pass by, stop just in front of the gate and kick. The gate falls and then starts to

**Your most formidable foe is a savage blue falcon.**

rise. As it reaches the top, run underneath before it crashes down again.

Karateka is a good adaptation of one-on-one karate, but I wish it included more offensive and defensive options and the ability to fight more than one opponent at a time. You can play the game either from the keyboard or with a joystick. Although the joystick is easier

to use, the keyboard gives you more control over your player. I do find the game intriguing, and it certainly holds enough action, graphics, and sound to please video-game black belts everywhere. Simulating the human form on screen is hard enough, much less duplicating fluid fighting movements. Give Brøderbund and programmer Jordan Mechner credit for producing a quality game.

*Russ Lockwood*

**Karateka**

Brøderbund Software  
17 Paul Drive  
San Rafael, CA 94903  
(415) 479-1170

**List Price:** \$34.95

**Requires:** Apple II Plus, IIe, or IIc; 48K RAM; one disk drive (two-button joystick recommended)

CIRCLE READER SERVICE NO. 363

**WILD BLUE YONDER**

Microprocessor engine! Check.

Joystick yoke? Check.

Flying goggles? You've got to be kidding. Real pilots don't wear goggles. No check.

Power on? Check.

All checked out? Check and double-check—take off!

Solo Flight takes you and your Apple into the wild blue yonder, even if you've never flown an airplane. This flight simulator is so easy to use that first-time fliers will be swooping low over Kansas cornfields and soaring past Mount St. Helens in no time.

You may choose to fly in one of three areas: Kansas, Washington, or Colorado. Each area retains the geo-

graphical features of the state. Thus, Kansas is generally flat, and Washington and Colorado are mountainous.

A replica of an instrument panel appears on the screen. Instruments include a throttle; altimeter; and

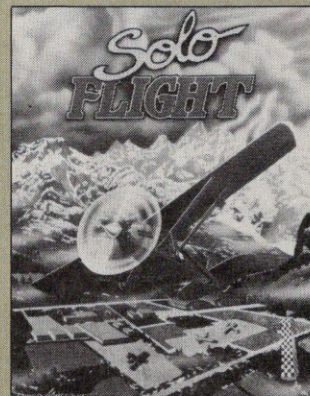

heading, bank, navigation, and pitch indicators. As with a real aircraft, the results are faithfully reproduced on your instrument

**The ADALAB™**  
Data Acquisition System For Laboratories

**Costs Less Than \$2300\***

• **ADALAB™** data acquisition system interfaces with virtually any lab instrument using a recorder or meter, including GC and HPLC systems, spectrophotometers, pH meters, process control apparatus, thermocouples, etc. Thousands of scientists use IMI products worldwide!

• **Lab Data Manager™** software (\$250) facilitates single or multi-channel acquisition, storage, display and chart recorder style output of lab instrument data.

\*\$2290 price includes 64K APPLE IIe, disk drive with controller, 12" monitor; dot matrix printer with interface; IMI ADALAB™ interface card.

**\$495 ADALAB™ INTERFACE CARD (available separately)**

includes 12-bit A/D, 12-bit D/A, 8 digital sense inputs, 8 digital control outputs, 32 bit real-time clock, two 16-bit timers plus QUICK I/O data acquisition software that works within easy-to-use BASIC.

Call, write or telex IMI for complete details!

†Trademark of Apple Computer, Inc.



**INTERACTIVE MICROWARE, INC.**  
P.O. Box 139, Dept. 209 Telex: 705250  
State College, PA 16804 (814) 238-8294

CIRCLE 324 ON READER SERVICE CARD

**DISK COPYING**

Whether you need 50 disks or thousands, we have years of experience in creating the highest quality copies. Reasonable prices—fast turnaround. Call today for our free booklet on software duplication and packaging.

**BLANK DISKS**

Can you tell a good disk from a great one? We can, because we copy thousands each day. We'll tell you which brand is best for your system. Call today—and get great prices, too!

Call ALF first

1-800-321-4668

in Colorado (303) 234-0871

**ALF**

ALF Products • Denver, CO

panel as you perform maneuvers and alter the control settings. The only missing equipment is a radio.

The graphics are not as sophisticated as those of Microsoft's Flight Simulator or other MicroProse flight simulators, but the program provides fairly smooth animation and enough graphics to give novice pilots an appreciation of real flying.

The one sticking point is the airplane itself. In Solo Flight, you see an out-of-cockpit view, except that the tail of your airplane appears in front of the windshield. I keep wishing for a machine gun to shoot myself out of the way. Furthermore, when you bank, the program tilts the plane rather than the horizon.

After performing barrel

rolls and corkscrew dives on other simulators and seeing the horizon sway drunkenly in front of me, I felt a bit disappointed after taking Solo Flight for a spin. It has no horizon rollover, and the plane interferes with the view of the runways.

Although the program does not include a "flight simulator," it does include a fun game called Mail Pilot. Neither rain, sleet, hail, nor snow must keep you from delivering mail to the airports in the area. Deteriorating weather conditions, mechanical failures, and several skill levels make this an interesting and challenging aerial odyssey.

Solo Flight is a good introduction to flight simulators. The more bloodthirsty pilots among you will find the lack of dogfights somewhat dull—you should try

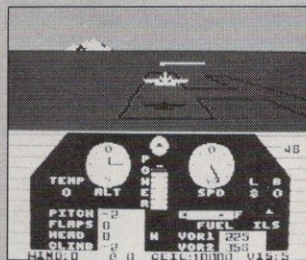

F-15 Strike Eagle by MicroProse. If you are looking for a calm afternoon of flying pleasure, however, Solo Flight may be right up your runway.

*Russ Lockwood*

#### Solo Flight

MicroProse Software  
10616 Beaver Dam Road  
Hunt Valley, MD 21030  
(301) 667-1151

List Price: \$34.95

Requires: Apple II, II Plus, IIe, or IIc; 64K RAM; one disk drive (joystick recommended)

CIRCLE READER SERVICE NO. 364

## TORTUOUS TIME TRAVEL

USAAdventure starts with a good idea—combine an adventure-game format with trivia questions about United States history, and then add some surefire graphics. The result should be an interesting, fascinating, and educational game. Alas, somewhere between the initial idea and the final result, a creeping boredom filters into the fun and robs USAAdventure of its educational value.

The whole idea is to travel throughout the U.S. and figure out the order in which the states came into the union. You start in Delaware, which happens to be the first state, and you then pick a compass direction from which to move around the country.

# BACK UP YOUR DISKS

NOW  
AVAILABLE  
AT YOUR LOCAL  
COMPUTER STORE

## ESSENTIAL DATA DUPLICATOR III™

EDD runs on Apple II, II plus, IIe, IIc and Apple III (in emulation mode) using one or two disk drives.

EDD allows you to easily and quickly make back up copies of your "uncopyable" Apple disks. ■ Since EDD has been preset to copy the widest range of copy-protections possible, you just simply boot up EDD, put the disk you want to copy in one disk drive and a blank disk in the other (EDD will work using one drive also) and in about 2 ½ minutes a copy is made. ■ Unlike the "copy-cards" which only copy "single load" programs, EDD copies the entire disk. This would be similar to hooking up two cassette recorders, playing from one, and recording to the other. ■ We have even included an option so you can check the speed of your disk drives because drive speeds running fast or slow can damage disks and cause other problems.

■ We publish EDD program lists (information about copy-protected disks) every couple of months, which EDD owners can receive. The current list is included with the purchase of EDD. ■ The bottom line is this; if EDD can't copy it, chances are nothing will.

**\$79.95**

Ask for EDD at your local computer store, or, to order direct; send \$79.95 plus \$2 shipping (\$5 foreign). Mastercard/Visa accepted. Prepayment required.

**UTILICO MICROWARE**  
3377 Solano Ave., Suite #352  
Napa, CA 94558 (707) 257-2420

**Warning:** EDD is sold for the sole purpose of making archival copies ONLY.

# PKASO/U®

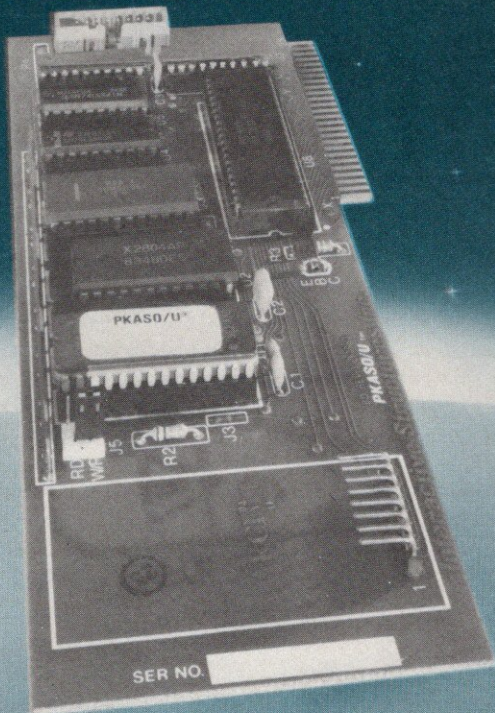

## The Universal Printer Interface

Apple II, IIe, III and Apple compatible.

- Universal for virtually all standard parallel printers.
- Famous for Graphics (LoRes, HiRes, SuperRes) (Logo Compatible)
- Terrific for text (even rotates spreadsheets to print sideways)

One set of commands for all printers. One command changes character sizes. Create your own printing fonts, alphabets and symbols... bold face, underline, italics, subscript and superscript, HiRes Zooming.



### PLUS:

FREE Utility and Demonstration Software Disk. CLEAR, comprehensive user documentation. PKASO/U... for all the reasons you need an interface.

Contact us for a list of Authorized Dealers near you.



Interactive Structures, Inc.  
146 Montgomery Avenue  
Bala Cynwyd, PA 19004  
Telephone: (215) 667-1713

CIRCLE 274 ON READER SERVICE CARD

## THAT'S entertainment

If you already know that Pennsylvania was the second state to come into the union, you head there immediately. If you don't know this fact, you are doomed to roam the map until you stumble across the right state.

Herein lies the game's major problem. It is boring to travel blindly around and through the states. Wandering through the country is akin to being lost in a maze. Scotty, beam me out of here!

### Test Your Knowledge of History

Once you do reach the appropriate state, if you have not reached a state of frustration first, the program presents you with several events associated with that state.

For example, in Pennsylvania, the available events include Lincoln's Gettysburg Address, the Declaration of Independence, and the Three Mile Island nuclear reactor mishap.

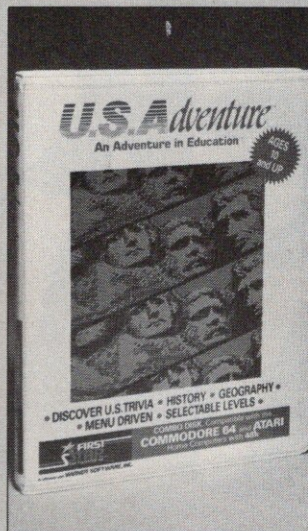

You then enter a time tunnel to guess the year in which the event occurred. To continue the example above, you time-travel to 1863, 1776, and 1979 for the correct answers about the events in Pennsylvania. If you do not find the cor-

rect date on the first try, the program tells you if the

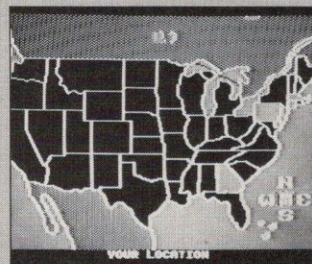

event falls before or after the year you selected.

The time tunnel sports colorful, almost hypnotic graphics. With the changing years in the center of the screen, the colors rush toward you or away from you, depending on whether you are traveling forward or backward in time. The map of the U.S. generally reproduces each state faithfully.

USAdventure holds many interesting facts, but moving around to get to the facts presents new adventures in tedium. Finding the order in which states were admitted into the Union seems to take forever. It would be better if the program allowed you to locate an event in history as you passed through a state.

If you need an educational program to help children memorize a sequence of events in U.S. history, USAdventure may be for you. Or you could pick up a couple of history books—you get a chronological listing of events as well as photos, maps, and the significance of each event in U.S. history.

*Russ Lockwood*

### USAdventure

First Star Software  
18 East 41st Street  
New York, NY 10017  
(212) 532-4666

**List Price:** \$34.95

**Requires:** Apple II, II Plus, IIe, or IIc; one disk drive; joystick optional

CIRCLE READER SERVICE NO. 365

# EMCO

**FREE PEN WATCH FOR  
ORDERS OVER \$50.00**

# (805) 499-6871

## FACTORY GUARANTEED QUALITY

### DETACHED KEYBOARD

**\$95.00**

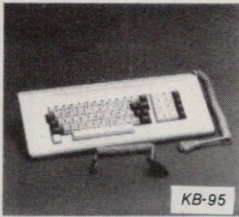

- Apple-Franklin compatible
- Programmer keyboard
- Enhance over 40% of keyboard functions
- Microprocessor control with Upper/Lower case
- 42 function keys
- 3 user-programmable keys
- Standard numeric key pad
- Power "ON" light
- Curly-cord connector and connector mate included

S & H \$5.00

### 5 1/4" DISKETTES

**\$1.00**

by ULTRA MAGNETICS ONLY \$1 EACH  
SS/DD G-Neric diskettes  
w/hub rings, sleeves & write  
protect tab (pkg. of 20) **\$20**

**FREE DISK DOUBLER**  
with purchase of 100 pcs Diskettes

S & H \$3.00

(Note: \$3.00 Shipping & Handling required on all diskette orders)

### FLIP 'N' SORT

**\$14.95**

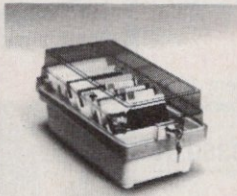

- Elegant appearance
- Key lock for file integrity
- Smoke top w/beige base
- Protect up to 100 5 1/4" diskettes
- Ten movable dividers
- Non-slip guides keep disks upright and flat

DX-85A

S & H \$4.50

### ADJUSTABLE MONITOR STAND

**\$12.95**

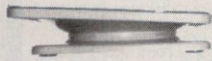

- Tilts and swivels display
- Rotates 360°
- Tilt-angle adjustable and lockable
- Rubber pads on top and bottom guarantee no slipping
- Holds all size monitors

S & H \$4.50

### JOY STICKS

**\$17.95**

HAND HELD



- Apple II + , Iie, Iic, or IBM pc compatible
- Self-centering w/metal handle
- Adjustable verticle and horizontal
- Hand-held model with AutoFire
- Please specify II + , Iie , Iic or IBM pc on order

S & H \$4.00

### FLIP 'N' CARRY

**\$11.95**

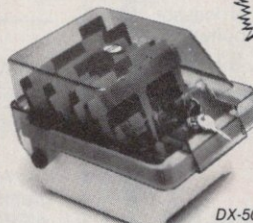

- Built-in carrying handle
- Elegant appearance
- Key lock for file integrity
- Smoke top w/white base
- Protect up to 50 5 1/4" diskettes
- Four movable dividers
- Non-slip guides keep disks upright and flat
- 6 1/2" H, 8 3/4" L, 7" W

DX-50A

S & H \$4.50

### IBM COMPATIBLE

TEAC 55B - 1/2 Height, DS/DD Drive . . . \$130

I<sup>2</sup> INTERFACE - 10.6 MB, Low Power Internal Winchester Disk System . . . \$645

I<sup>2</sup> INTERFACE - 10.3 MB Backup Tape for IBM/pc with one free tape . . . \$625  
Tape only . . . \$35

I<sup>2</sup> INTERFACE - 21.1 MB, 1/2 Height Winchester for IBM pc/AT Upgrade Kit \$799

### DISK DOUBLER

**\$9.95**



- Accurate position guide
- Hand-held compact design
- Square notch-cut
- Sturdy, all-metal construction

S & H \$4.00

### COOLING FAN

**\$29.95**



- New super-thin design
- Adjustable: fits all cases
- Dual outlets for monitor and printer
- Heavy duty switch w/power on pilot light
- Built-in power surge protection
- Also fits Commodore model 1541 drive

AP92

S & H \$4.00

### RF MODULATOR SET

**\$9.95**

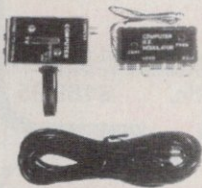

- RF Modulator
- TV Interface
- Coaxial Cable

S & H \$4.00

### EXTERNAL PORT

ONE PORT **\$4.95**  
FOUR PORT **\$12.95**



- Apple II + I/O extender
- Easy access to I/O
- One-port or four-port available
- Control by individual switch

S & H \$4.00

### VIDEO 'FLIPPER'

**\$9.95**

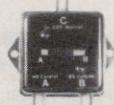

- Easily flips from 40 to 80 column mode and back
- One computer to two monitors connection and select
- Two computers to one monitor connection and select

S & H \$4.50

### ANTI-GLARE PANEL

**\$29.95**

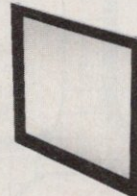

- Fit 12" to 14" Video Display Terminals
- Reduce Glare from VDTs on color and monochrome screens
- Enhance the contrast between image and background
- Easy mounting

S & H \$4.00

### FLOPPY DISK DRIVE HALF-HEIGHT

**\$145**

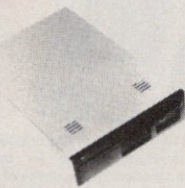

- Apple compatible 5 1/4"
- 250 KB disk capacity (unformatted)
- High-speed (6 ms) access time
- 149 x 45 x 230 mm
- Made in Japan

S & H \$6.00

### MONITORS

**\$100**

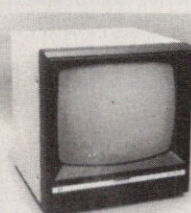

#### AMBER :

- Amber HI-RES monitor
- 12" display
- Non-glare screen finish
- 20 MHz
- 1000 lines @ center

**\$225**

#### COLOR :

- Color/Green selectable
- 14" display
- Audio/video input
- Audio/video output
- Volume control

S & H \$13.00

### APPLE™ COMPATIBLE

**\$199.00**

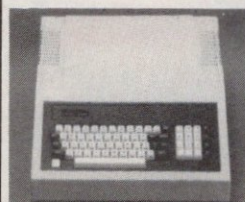

CK 199

- INCLUDES (as shown):
- **CASE:** ABS case in light beige, w/spacer for easy motherboard mounting
  - **KEYBOARD:** Same features as KB-95 (above) exc. assembled in case for easy mother BD connection
  - **SWITCHING P.S.:** 110/220 select. 5V/5A, 12V /2.5A, -12V/5A, -5V/5A; in case w/power cord and connector.
  - **RF MOD. SET:** RF modulator, coaxial cable, TV interface.
  - **SPEAKER:** Mounted w/cable and plug.

S & H \$12.00

• WANTED • DEALERS • DISTRIBUTORS •

## EMCO (805) 499-6871

3541 OLD CONEJO ROAD, SUITE 111  
NEWBURY PARK, CA 91320

PRICES AND AVAILABILITY SUBJECT TO CHANGE WITHOUT NOTICE

**VISA  
MASTERCARD  
ACCEPTED**

Please add on 4%  
for VISA or MasterCard  
orders.

#### TERMS:

- Cashier's check or money order only
- **FREE S & H charges for prepaid orders**
- C.O.D. orders please add on S & H charges
- California residents please add 6% sales tax
- 10% restocking charge for orders returned or refused
- Extra S & H charges for outside U.S.A.

**GUARANTEE: 90 days DELIVERY: UPS, stock to 4 weeks**

**\* SUMMER SALE \***

**APPLE\* MODEMS**

by Prometheus

New 300/1200 Baud 212A Telephone Modem for your Apple II, II+ and IIe. Just plug in - Hayes compatible!

PM1200A... \$299.95

**MAC PAC**

for your Macintosh

Includes: ProModem 1200 external modem, cable and software.

MAC PAC... \$369.95

**OPTION SPECIAL!**

**Lowest Price!**

Includes options processor, display and 64K buffer.

PM-Special.. \$169.95

**Additional Apple Products**

**Apple Cooling Fan**

for Apple II, II+ and IIe

APF-1..... \$39.95

**Switching Power Supply**

for Apple II, II+ and IIe

KHP4007... \$59.95

**SALE!**

**12" Monochrome Green Monitor for APPLE II, II+, IIe & IIc**

- Excellent resolution
- 80 character x 24 line display format
- Complete with tilt/swivel monitor stand!

MON-12G \$79.95

**80-Column plus 64K RAM for your APPLE IIe\***



**AppleWorks\* Compatible!**

Now you can double the memory capacity and get an 80-column display format for your APPLE IIe\* computer at an affordable price. Just plug the JE864 card into your APPLE\* and expand your display to 80 characters per line. Perfect for word processing. The JE864 also features 64K bytes of additional memory to allow programming not possible with standard APPLE IIe\* computers. Complete documentation included.

**Board:** High density board design squeezes 64K bytes of RAM onto a 2 1/2" x 4 1/2" board • Fully tested to assure proper operation.

**Uses:** Word processing - displays 1000 more characters per screen • Extra memory allows running of extremely large programs • Ultra High Resolution Graphics capability.

JE864..... \$79.95



Serving the Computer Enthusiast Since 1974

**QUALITY COMPUTER PRODUCTS FOR APPLE II, II+, IIe, IIc and Macintosh\***

**APPLE\* Compatible CARDS**

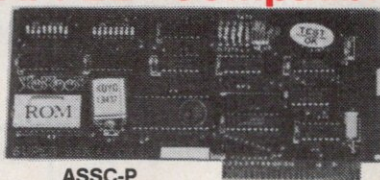

Key:

- a = Apple II or II+
- b = Apple IIe

ASSC-P

**16K RAM Card (Language Card)**

The ARC-16K RAM Card allows the Apple\* II and II+ computers to expand from 48K to 64K. Complete with instructions. Key: (a)

ARC-16K..... \$39.95

**Z-80 CP/M Card**

The AZ80-1 is Soft-card compatible. Used with CP/M related programs. Key: (a,b)

AZ80-1..... \$49.95

**EPROM Burner Card**

The AEB-2 allows user to program and work with standard EPROMs (2716, 2732 & 2764). Easy to use, on-board firmware. Menu contains the following options: Write, Read, Copy, Compare, Blank-Check and Monitor. Complete with instructions. Key: (a,b)

AEB-2..... \$69.95

**80-Column Card w/Soft Switch**

The A80-C is an 80-column card designed for the Apple\* II and II+ computers. The card is equipped with a soft switch which allows easy hookup for any monitor. The A80-C also features inverse video capabilities. This card is similar to the Videx\*\*\* 80 column card. Complete with instructions. Key: (a)

A80-C..... \$74.95

**Super Serial Card**

The ASSC-P is a serial card with a printer mode. It generates standard RS-232C signals and is similar to the Apple\* Super Serial Card. Complete with instructions. Key: (a,b)

ASSC-P..... \$99.95

**APPLE™ Compatible 5 1/4" Disk Drive and Controller Card**



- Uses Shugart SA390 mechanics
- 143K formatted storage • Color matches Apple Computer • Works with Apple Controller or other Apple-compatible controllers (ACC-1)
- Complete with connector - just plug into your disk controller card
- 35 tracks • Size: 6" W x 3 1/2" H x 8-9/16" D • Wt.: 4 1/4 lbs. (Disk Drive)

ADD-514 (Drive) \$149.95

ACC-1 (Controller Card) \$49.95

**APPLE™ Compatible 5 1/4" Half-Ht. Disk Drive**



- Uses Chicon Pinch-type mechanics
- 163K unformatted • 35 tracks • Super quiet • Works with Apple Controller or other compatibles (ACC-1) above
- Complete with connector - just plug into your controller • Size: 5 3/4" W x 1 1/2" H x 8" D • Wt.: 4 lbs.

ADD-12... \$159.95

**APPLE™ IIc Compatible 5 1/4" Half-Ht. Disk Drive**

- Same specs as ADD-12 (above) except no controller necessary.

ADD-IIc. \$169.95

**NEW!**

**APPLE Keyboard and Case for Apple II and II+\***



**KEYBOARD (KB-A68):**

- 68 Keys • 15-Key Keypad • Direct connection with 16-pin ribbon connector • Special functions on number keys, including cursor controls, color demo, and one-touch disk catalog • Metal baseplate for durability (with 6 mounting holes) • Color (keys): white/grey • Size: 14 1/2" L x 5 1/2" W x 1 1/2" H

**CASE (EAEC-1):**

- Accommodates KB-A68 • Pop-up lid for easy access • Fits power supply and motherboard too • Size: 15 1/2" W x 18" D x 4 1/4" H

Part No.	Description	Price
KB-EA1	Apple Keyboard and Case.....	\$134.95
KB-A68	68-Key Apple Keyboard only.....	\$ 79.95
EAEC-1	Expanded Apple Enclosure Case only.....	\$ 59.95

\$10.00 Min. Order - U.S. Funds Only  
Calif. Residents Add 6 1/2% Sales Tax  
Shipping - Add 5% plus \$1.50 Ins.  
Send S.A.S.E. for Monthly Sales Flyer!

Send \$1.00 Postage for your  
FREE 1985 JAMECO CATALOG  
Prices Subject to Change



1355 SHOREWAY ROAD  
BELMONT, CALIFORNIA 94002

Phone Orders Welcome (415) 592-8097

Telex No. 176043

7/85

**Numeric/Auxiliary Keypad for your APPLE IIe\* Visi Calc\*\* Users!**



The JE614 is a newly introduced numeric/auxiliary keypad for the APPLE IIe.\* It offers the flexibility of a 10-key pad and the convenience of 23 directly accessible functions. Screen manipulating functions make word processing a snap and cursor controls make the keypad ideal for VisiCalc\*\* users. The JE614 Keypad is housed in a durable metal enclosure and is color-coordinated with your APPLE IIe computer. Operation of the keypad can begin within minutes from unpacking. Special functions include: Home, Clear, Clear to End of Screen, Scroll-Up, Scroll-Down, Tab, Delete, Left, Right, Up and Down. Each key has auto-repeat. Size: 5 7/8" L x 4-3/16" W x 1 1/4" to 2 1/8" Slope.

JE614..... \$49.95

**SPEAKING OF GRAPHICS  
BY ROBERTA SCHWARTZ  
AND MICHAEL CALLERY**

New books and new products for the Apple II and the Macintosh

# READING, WRITING, AND DRAWING

Your letters are arriving, and so far we've answered about half of them. Please be patient while we get to the rest.

## Books on Apple Graphics

One question that pops up frequently is: Are there any good books on Apple graphics? Here are a few titles we recommend to our students.

For a good overview of Apple computers—from soup to nuts—we like Lon Poole's *Apple II User's Guide* (Osborne/McGraw-Hill).

*Microcomputer Graphics* by Roy Meyers (Addison-Wesley) has many Applesoft BASIC programs that illustrate concepts such as high-resolution text generation, 3-D transformations, hidden-line removal, clipping, and so on. Some mathematical background is helpful if you use this book.

*Apple II Computer Graphics* by Ken Williams and R. and L. Kernaghan (Brady Publishers) is a comprehensive graphics book with an emphasis on animation and game design. The book covers low-resolution, high-resolution, block shapes, Applesoft shapes, and more.

*Art and Graphics on the Apple II/IIe* by W.H. DeWitt (Wiley Press) has many Applesoft BASIC programs that produce interesting graphic designs.

If you'd like a more complete computer-graphics bibliography, send us your request with a stamped, self-addressed envelope. We'd like to be immodest and mention our book, but it won't be available until the fall.

We've received a copy of a new product that gives the Apple II superhigh resolution in black and white. The Graphics Tool Kit consists of an interface card and software. It appears to be an excellent utility for specialized graphics applications such as CAD/CAM, music composition, and so on. We want to spend a little more time

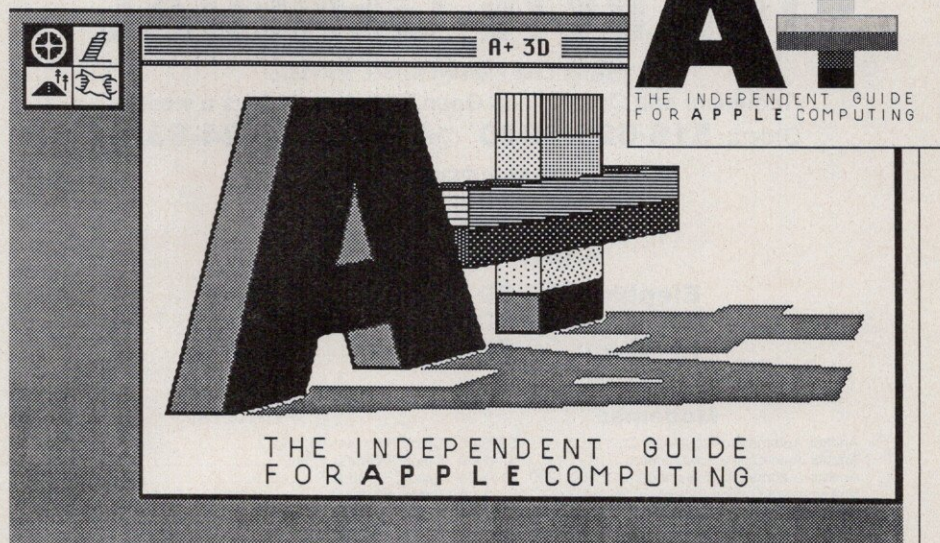

Using MacPaint and the perspective and stretch features of Click Art Effects, we created this three-dimensional logo with a cast shadow.

with it, so we'll tell you more in our next column.

We're happy to say that Penguin Software has released a double-hi-res version of its classic program The Complete Graphics System. The package comes with a two-sided disk: one side has the standard hi-res version, and the other side has the double-hi-res version. In addition, Penguin has released a new program, Magic Paintbrush. Described as a computer drawing program for beginners, this program is essentially a watered-down version of the Draw and Paint modules in CGS. Magic Paintbrush comes with the Apple standard and double-hi-res version on one side of the disk and a Commodore version on the other side. Both programs are a welcome addition to the company's fine line of graphics software.

## Double-Hi-Res Blues

If you've been exploring double hi-res with the commercially available utilities, you're probably a bit frustrated. Some of these programs work under ProDOS, and some work under

DOS. If you're like us, you've made more than your share of conversions from DOS to ProDOS and back. Getting the picture onto the correctly formatted disk is only half the problem, however. Unfortunately, there's little standardization in the way a double-hi-res picture is stored. The result is that pictures you create with one program won't be accepted by another.

A double-hi-res image occupies two discontinuous areas of memory; half the image is in main memory and half in auxiliary memory (see "Seeing Double," *A+*, December 1984). The image, then, is obviously saved in two files, one holding the main image and the other the auxiliary image—or is it?

According to Peter Joselow, the coauthor of DoubleStuff, Apple requested that developers save double-hi-res images to one file, with the auxiliary portion of the picture stored first and the main portion following. There's rhyme to the reason—this format is identical to the format on the Apple III (which has had double hi-res all along).

Of the currently popular packages, however, only Dazzle Draw saves each picture to one file. Beagle Graphics and the double-hi-res Complete Graphics System use a two-file format.

Like us, you may want to use all three packages to produce one finished graphic. We use Dazzle Draw for its ease of drawing and its editing options, Complete Graphics System for its exotic brushes and "tricks," and Beagle Graphics for its programming capabilities and its packed-picture slide-show utility.

### How to Get from There to Here

If you have a drawing you made with Dazzle Draw that you want to work on with either of the other double-hi-res packages, you'll have to convert the picture file to DOS 3.3 and then split the file in half. To do this, exit from Dazzle Draw and use the File Convert program on the ProDOS User's Disk or the Apple IIc (or IIe) System Utilities Disk to convert the Dazzle Draw picture file to DOS 3.3. Next, BLOAD the file to address 8192 (\$2000) with the command

BLOAD filename,A8192 (Return)

Your next step depends on whether you want to use your picture with Beagle Graphics or Complete Graphics System; the two programs require different filename suffixes.

If you're using Beagle Graphics, type

BSAVE filename.AUX,A8192,L8188 (Return)

BSAVE filename,A16384,L8188 (Return)

If you're using Complete Graphics System, type

BSAVE filename.DPA,A8192,L8188 (Return)

BSAVE filename.DPM,A16384,L8188 (Return)

You can now use your Dazzle Draw double-hi-res picture in either of the other two double-hi-res programs.

If you're using the ProDOS version of Beagle Graphics, you can skip the DOS 3.3 conversion, but you still must split the Dazzle Draw picture file into main and auxiliary portions, using the above commands.

To go in the opposite direction (from Beagle Graphics or CGS to Dazzle Draw), you must save your two-file picture as a one-file picture. To do so, BLOAD the picture onto the screen (both the main and the auxiliary). Type

BLOAD filename.AUX,A8192 (Return)

BLOAD filename,A16384 (Return)

This is the main portion of the picture. Then type

BSAVE filename,A8192,L16384

You now have your double-hi-res image saved as one file. Convert this DOS 3.3 file to ProDOS, and you're all set.

### More for the Mac

We recently had the opportunity to see some of the latest graphics software and hardware for the Macintosh. One of the most notable programs is ClickArt Effects. With this desktop utility you can capture an image (or a part of it) and rotate it, slant it, stretch

# THE BYTE GENERAL

3 Sierks Lane • Roslyn Harbor, NY 11576

Technical and Order Lines Open 24 hours, 7 days a week!!!

Orders: **516-625-0920** Technical: **516-484-6391**

**FREE AIR SHIPPING!** on prepaid orders

**WE BEAT PRICES!!**

PLEASE REFER TO: **AD # 35**

**Elephant SS/SD ..... \$12.95**  
**Elephant SS/DD ..... \$13.95**  
**Elephant DS/DD ..... \$15.95**

### Modems:

Anchor Automation Signalman 300/1200.....	\$229.00
Anchor Automation Volksmodem.....	\$ 49.00
Anchor Automation Volksmodem 12 300/1200.....	\$189.00
Volksmodem Cables (Specify Computer).....	\$ 15.00
Hayes Smartmodem 300.....	\$199.00
Hayes Smartmodem 1200 Ext. (Standalone).....	\$399.00
Hayes Smartmodem 1200B IBM Internal w/Smartcom.....	\$380.00
Hayes Smartmodem 1200B IBM Hardware Only.....	\$350.00
Hayes Smartmodem 2400.....	\$699.00
Hayes Smartmodem 300 IIc w/Smartcom and Cable.....	\$239.00
Hayes Micromodem IIe w/Smartcom II.....	\$215.00
Novation Apple Cat II.....	\$205.00
Novation Apple Cat 212 System.....	\$375.00
Novation Apple Cat 212 Upgrade.....	\$225.00
Novation Smartcat Plus Macintosh.....	\$349.00
Prometheus Pro-Modem 1200 Ext.....	\$325.00
Prometheus Pro-Modem 1200A Apple Int.....	\$335.00

### Monitors:

Amdek Color 300 Composite.....	\$249.00
Amdek Color 600 RGB Hi-Res.....	\$425.00
Amdek 300 Amber.....	\$149.00
Amdek 300 Green.....	\$129.00
Princeton HX-12 RGB Color Hi-Res.....	\$475.00
Princeton MAX-12 Monochrome.....	\$175.00
Sakata Amber SA-1000.....	\$125.00
Sakata Green SG-1000.....	\$110.00
Sakata Color SC-100 Composite.....	\$230.00
Sakata Color SC-200 RGB Hi-Res.....	\$425.00

### Disk Drives:

Apple Brand Disk Controller.....	\$ 55.00
Shugart Apple Disk Drive.....	\$149.00
Rana Elite I.....	\$215.00
Tandon Tm-100-2 DS/DD Disk Drive (IBM).....	\$149.00

### Diskettes:

Elephant SS/SD 5 1/4 Diskettes.....	\$ 12.95
Elephant SS/DD 5 1/4 Diskettes.....	\$ 13.95
Elephant DS/DD 5 1/4 Diskettes.....	\$ 15.95
Elephant Macintosh Diskettes.....	Call
Elephant Bulk SS/DD Diskettes (50 Disks).....	\$ 60.00

### Printers:

C.Itoh Prowriter 8510ap.....	\$310.00
C.Itoh Prowriter 1550P.....	\$520.00
Epson RX-80 F/T.....	\$290.00
Epson RX-80.....	\$239.00
Epson FX-80.....	\$415.00
Epson FX-100.....	\$599.00
Star Gemni SG-10.....	\$240.00
Star Gemni SG-15.....	\$379.00
Juki 6100 Daisy Wheel Printer.....	\$410.00
Okidata 92ml.....	\$359.00
Okidata 92ml IBM Plug & Play.....	\$359.00
Okidata 92S Macintosh/IIc Version.....	\$420.00
Okidata 93ml.....	\$625.00
Cables For Above Printer.....	\$ 26.00
Okidata 92 Ribbons.....	\$ 2.00
C.Itoh Prowriter Ribbons.....	\$ 6.00
Epson MX/FX/RX80 Ribbons.....	\$ 5.00
Silver Reed EXP-400.....	\$279.00
Silver Reed EXP-500.....	\$350.00
Silver Reed EXP-550.....	\$415.00

### Apple Accessories:

Gibson Light Pen.....	\$165.00
Koala Pad Apple II/IIe Version.....	\$ 69.00
Koala Pad Apple IIc Version.....	\$ 69.00
Kraft Apple II/IIe Joystick.....	\$ 34.95
Kraft Apple II/II Joystick.....	\$ 34.95
Generic Kraft Joystick IIe/IIc/II.....	\$ 28.00
Thunderclock.....	\$109.00
ALS Z Engine Hardware w/CPM 2.2.....	\$125.00
ALS Smarterm II 80 Column Card.....	\$129.00
Advanced Logic Systems Dispatcher Serial Card.....	\$ 89.00
MPC 64k Extended 80 Column Card IIe.....	\$ 99.00
MPC Parallel Printer Card.....	\$ 55.00
Echo Speech Synthesizer.....	\$ 99.00
Grappler Plus.....	\$110.00
Buffered Grappler Plus.....	\$170.00
MA Systems Omnigraph (Same As Grappler Plus).....	\$ 69.00
16k Ram Card.....	\$ 55.00
Z80 CPM Card.....	\$ 69.00
6 Outlet Surge Protector.....	\$ 29.00
Kensington System Saver Fan.....	\$ 65.00
Super Cooling Fan (2 Outlet w/Surge Protector).....	\$ 35.00
Videx 80 Column Card w/Inverse/Soft Switch.....	\$209.00
Videx Ultraterm 160 Column Card.....	\$229.00

### DEALER INQUIRIES INVITED

**Terms:** Please use item numbers when ordering. NYS Residents add 8.25% sales tax. Personal/corporate checks — allow 2 weeks to clear. Prices do not include shipping and handling charges unless prepaid orders. Prices are subject to change without notice. We are not responsible for typographic errors. There is a 30 day time limit on all returns. After 30 days, all sales are final, and defective material must be sent directly to the manufacturer. All orders returned, refused, or ordered in error are subject to a 10% restocking fee. Prices reflect a 3% cash discount.

CIRCLE 306 ON READER SERVICE CARD



# don't shop in the dark for apple products!

A+ BUYERS GUIDE is the master directory of hardware, software, peripherals and services available for the Apple II, II+ , IIc, IIe, III, Lisa and Macintosh! Because A+BUYERS GUIDE is published every six months, it is the most up-to-date sourcebook available to help you with your purchasing decisions!

You'll turn on the light to over 3,500 product listings covering:

- SOFTWARE:** Business, Professional, Educational, Personal, Recreational, Programming and other System Software.
- HARDWARE:** Compatible Computers, Cards, Monitors, Printers, Plotters, Disk Drives, Mass Storage and Expansion Units, Modems, Game Devices, Light Pens, Voice and Sound-Related Hardware and more!
- SERVICES AND ACCESSORIES:** Furniture, Storage Media, Dust Covers, Carrying Cases, Display and Printer Accessories, Stationery, Keyboards and Software Overlays, Security Devices, Literature, On-Line Bulletin Boards, Professional Societies, User Groups and Maintenance, Marketing, Rental, Duplication and Insurance Services, and more!

THIS IS THE ENCYCLOPEDIA OF EVERY SIGNIFICANT PRODUCT AND SERVICE AVAILABLE FOR YOUR APPLE!

Each description provides you with the essential information you need to evaluate what each product does *and* what you need to use it!

Don't shop in the dark again...order your copy of A+BUYERS GUIDE *today!*

**ALSO AVAILABLE AT YOUR  
LOCAL NEWSSTAND, BOOKSTORE  
AND COMPUTER STORE**

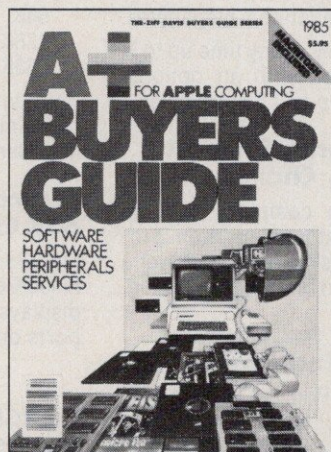

## A+ BUYERS GUIDE

AN17

CN 1914, Morristown, NJ 07960

Please send me A+ BUYERS GUIDE. Enclosed is \$7.50 (\$5.95\* per copy plus \$1.55 postage and handling). (Outside USA \$9.00 US funds only.) \* Residents of CA, CO, CT, DC, FL, IL, MA, MI, MO, NJ and NY add applicable sales tax.

**Charge My:**  AMEX  Visa  MC

Card No. \_\_\_\_\_ Exp. Date \_\_\_\_\_

Mr./Mrs./Ms. \_\_\_\_\_  
print full name

Address \_\_\_\_\_

City/State/Zip \_\_\_\_\_

FROM THE PUBLISHERS OF  
A+, THE INDEPENDENT GUIDE FOR APPLE COMPUTING

it, and/or distort it. If you work with MacPaint, this utility is a must!

Hayden's Video Works is an exciting musical-animation package for the Mac. Watch for a complete review in an upcoming issue of *A+*.

Magic Slate is an interesting program that lets you create fast, bold, abstract images. The program gives you a variety of pens and patterns to work with. Pen sizes range from small to huge. This program is not for detailed drawing and painting, but rather for "creative expression."

ColorPrint lets you print MacPaint documents in color. We will take a look at ColorPrint, colored ribbons, and iron-on ribbons next month. Hint: If you can't wait for the review and you have the patience to swap Imagewriter ribbons, do get ColorPrint. The results are excellent. The process is tedious, but it'll have to do until we get a color Macintosh.

#### Keep Drawing

That's it for now. Keep reading, keep writing, and—most important—keep drawing. **+**

## ▶ PRODUCT INFORMATION

### Beagle Graphics

Beagle Bros. Micro Software, Inc.  
4315 Sierra Vista  
San Diego, CA 92103  
(800) 227-3800

**List Price:** \$59.95

CIRCLE 351 ON READER SERVICE CARD

### ClickArt Effects

T/Maker Graphics  
2115 Landings Drive  
Mountain View, CA 94043  
(415) 962-0195

**List Price:** \$49.95

CIRCLE 352 ON READER SERVICE CARD

### ColorPrint

Esoft Enterprises  
P.O. Box 179  
Owasso, OK 74055  
(918) 272-7616

**List Price:** \$49.95

CIRCLE 353 ON READER SERVICE CARD

### The Complete Graphics System and Magic Paintbrush

Penguin Software  
830 4th Avenue  
P.O. Box 311  
Geneva, IL 60134

**List Price:** CGS, \$79.95; Magic Paintbrush, \$34.95

CIRCLE 354 ON READER SERVICE CARD

### Dazzle Draw

Brøderbund Software  
17 Paul Drive  
San Rafael, CA 94903  
(415) 479-1170

**List Price:** \$49.95

CIRCLE 355 ON READER SERVICE CARD

### The Graphics Tool Kit

Demco Electronics  
10516 Grevillea Avenue  
Inglewood, CA 90304  
(213) 677-0801

**List Price:** \$595

CIRCLE 356 ON READER SERVICE CARD

### Magic Slate

Devionics  
P.O. Box 2126  
Covina, CA 91722  
(714) 779-7193

**List Price:** \$99

CIRCLE 357 ON READER SERVICE CARD

### Video Works

Hayden Software  
600 Suffolk Street  
Lowell, MA 01853  
(800) 343-1218

**List Price:** \$99.95

CIRCLE 358 ON READER SERVICE CARD

Expand the Apple //e from 64K to 1.5 megabytes with

## MAXIRAM //e™

Has AppleWorks warned "Desktop Full" too often? Then you've outgrown your old 64K extended memory card.

### Add Memory When You Need It

MaxiRam solves memory shortages with a whopping 1.5 megabyte capacity that you can grow into.

Buy MaxiRam from your dealer with as little as 64K or as much as ¾ megabytes.

Easily add memory at any time up to ¾ of a megabyte or, with an optional extension card, up to 1.5 megabytes.

### AppleWorks Support At No Charge

MaxiRam comes complete with an Appleworks desktop expansion program allowing desktop space of over a megabyte and ram fast program speed.

### Designed for Greater Processing Power

Exclusive to MaxiRam is a built-in CPU port permitting direct linear memory addressing, up to 1.5 megabytes, by 16 bit microprocessors from the 8086, 68000, and 65816 processor families.

### Ask your dealer for:

MaxiRam //e, the expandable memory card for the //e, or MaxiRam C, 256K or 512K add-on memory for the //c

Five year warranty on all cards.

Apple, AppleWorks and ProDOS are registered trademarks of Apple Computer, Inc.



## Checkmate Technology, Inc.

509 South Rockford Drive  
Tempe, Arizona 85281  
(602) 966-5802 (800) 325-7347

CIRCLE 128 ON READER SERVICE CARD

# WIN THE CREATIVE COMPUTING EDITOR'S CHOICE SWEEPSTAKES!

Here's your chance to win your dream system selected by the experts!

Simply return the official entry card today and you're eligible  
to win either a Macintosh or IBM PC system worth up to \$5,000!

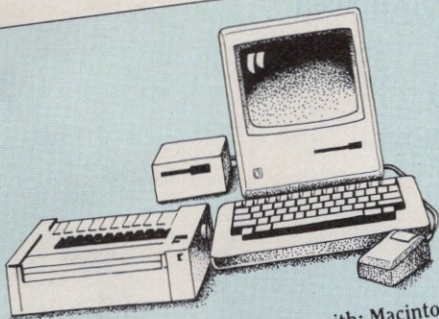

Apple Macintosh system complete with: Macintosh 512K computer / external disk drive, Imagewriter printer and General Computer Hyperdisk drive. Manufacturer's suggested price: \$4,900.

OR

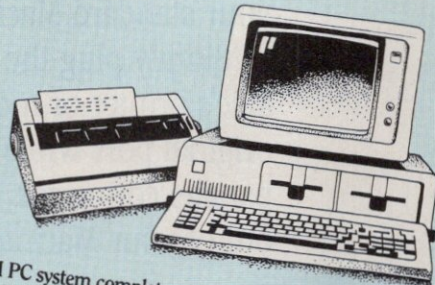

IBM PC system complete with: IBM PC (256K), IBM Graphics Printer, Graphics adapter, IBM Color Monitor, PC DOS 2.1 Operating System and AST SixPak Plus multifunction board (384K). Manufacturer's suggested price: \$4,600.

## Make your system—any system—a winner every month!

Check the YES box on the official entry card and guarantee the latest facts and applications for your system with CREATIVE COMPUTING, the magazine that's 100% compatible with all systems! Every month you'll receive new applications, in-depth product reviews and tested innovative ways to use your micro in your office or at home!

Now is the time to subscribe to the magazine that helps you grow with your system—and you'll save 50% off the regular annual subscription price!

**ENTER TODAY!**

### OFFICIAL RULES

Enter as many times as you wish—No purchase necessary!

1. On an official entry form or a 3" x 5" piece of paper, hand-print your name, address and zip code. Enter as often as you wish, but mail each entry separately to CREATIVE COMPUTING, EDITOR'S CHOICE SWEEPSTAKES, P.O. BOX 5215, Boulder, Colorado 80322. Entries must be received no later than August 30, 1985 and the drawing will be held by September 30, 1985. All entries become the property of CREATIVE COMPUTING, which reserves the right to reprint the name and address of winner.

2. The winner will be selected in a random drawing from among all entries received, under the supervision of the publishers of CREATIVE COMPUTING, whose decision will be final. Only one prize will be awarded in this Sweepstakes. Winner will be notified by mail and may be required to execute affidavit of eligibility and release. Odds of winning depend on the number of entries received. CREATIVE COMPUTING will arrange delivery of prize. Taxes are the responsibility of the winner. Any manufacturer's claims and warranties will apply, but CREATIVE COMPUTING makes no claims or warranties with regard to any prizes. Prize is not transferable. No substitutions for prizes.

3. Sweepstakes is open to all residents of the U.S., its territories and possessions, except employees (and their families) of CREATIVE COMPUTING, its affiliates, and its advertising and promotion agencies. Void wherever prohibited or restricted by law.

4. For the winner's name, send a stamped, self-addressed envelope to CREATIVE COMPUTING EDITOR'S CHOICE SWEEPSTAKES, Circulation Dept., One Park Avenue, New York, NY 10016.

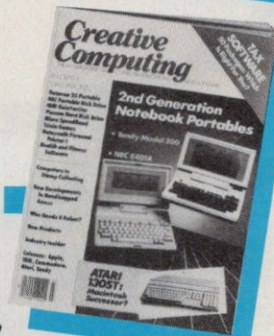

CREATIVE COMPUTING  
EDITOR'S CHOICE  
SWEEPSTAKES  
P.O. Box 5215  
Boulder, Colorado 80322

8Z292

**YES**, Enter my name in the Creative Computing Editor's Choice Sweepstakes and begin my subscription to Creative Computing for one year (12 information packed issues) for only \$12.49—a savings of 50% off the regular one-year subscription price of \$24.97!

If I win, I want the  Macintosh System  IBM PC System

No, I don't want to subscribe now, but tell me if I've won.

Mr./Mrs./Ms. \_\_\_\_\_ please print full name

Company \_\_\_\_\_

Address \_\_\_\_\_

City \_\_\_\_\_ State \_\_\_\_\_ Zip \_\_\_\_\_

Check one:  Payment enclosed  Bill me later

Charge my:  American Express  Visa  MasterCard

Card No. \_\_\_\_\_ Exp. Date \_\_\_\_\_

Offer valid in US and its possessions only. Void where prohibited. Please allow 30 to 60 days for delivery of first issue.

# Port Power

Introducing the Mac-Port-Adapter. Your Macintosh connection to the world of IBM-compatible peripherals. Designed to expand the capabilities of your Macintosh, the Mac-Port-Adapter allows you to team your Mac with top-of-the-line parallel peripherals. *And* keep your standard Macintosh serial port.

Simply plug the Mac-Port-Adapter into Mac's printer or modem port. You keep your original port while adding an IBM-type parallel connector. So, you get more out of your Macintosh, for very little.

List Price \$79.

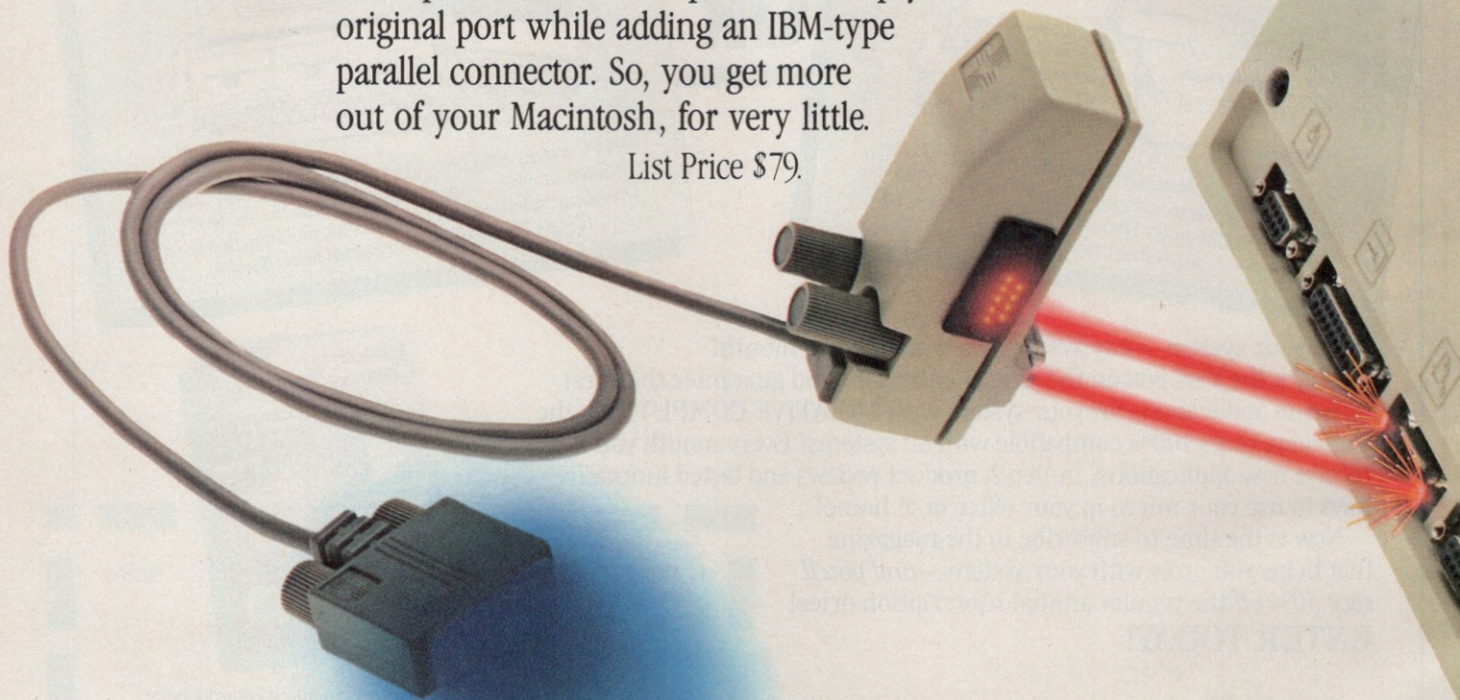

Mac-Port-Adapter includes a five-foot-long parallel cable with a 36-pin Centronics connector.



**Assimilation™**

1 (800) MAC-5464 • In California 1 (800) 421-0243

Macintosh is a trademark licensed to Apple Computer. Mac-Port-Adapter is a trademark of Assimilation, Inc. © Assimilation, Inc. 1985.

CIRCLE 212 ON READER SERVICE CARD

▶ A+ / JULY 1985

# Macintosh

FEATURING THE APPLE 32 LINE

## Public-Domain Software

Microsoft BASIC 2.1 Tutorial

Hogan Looks at the New Finder and MacForth



A32  
P.O. BOX 634  
SANTA CLARA, CA 95062

MS  
SS  
5.25  
Single Side  
144TP

A32  
P.O. BOX 634  
SANTA CLARA, CA 95062

Mac  
Library  
Disk  
No. 6



Public-domain  
software  
for the  
Macintosh

# PENNY-WISE PROGRAMS

Did you know that many interesting Macintosh programs are available for little or no cost? If not, then you haven't heard about public-domain software. *Public-domain software* refers to programs that you can copy freely without having to worry about violating copyrights. The authors of public-domain programs are generous souls who are willing to share the fruits of their labor with the computer-using public.

**T**he number of public-domain programs for the Mac is increasing continuously. *A+* already knows of more than 30 diskettes filled with public-domain software for the Macintosh that users' groups and other organizations are distributing. If you like the idea of building a large software library at a low cost, then public-domain software is the way to go.

Earlier this year, *A+* covered public-domain software for the Apple II series (see "Software on a Shoestring," January 1985, pages 71-78).

In this first part of a two-part article, I take a look at some of the most interesting and useful Macintosh application and utility programs in the public domain. Next month, I'll cover many of the other types of programs available. But first, the answers to two

questions: What is public-domain software, and where do you find it? **Methods to Their Madness**

The term *public-domain software* seems to imply that all public-domain programs have the same basic characteristics. They do, in fact, share one very important quality: You can copy all of them freely and legally for personal use. Otherwise, the differences are usually greater than the similarities—software writers seem to create new ways of sharing their programs every day. The most common of these variations is also the simplest: The software is uncopyrighted, with no strings attached. You should assume that one string is, in fact, implied (if not explicitly attached): that the software is provided for personal use only. (If you want to use it in any other way, you should obtain permission from the author.)

Most of the other major approaches to public-domain software involve a copyright, but the authors give their permission for personal use to anyone possessing a copy. Some authors stop right there, but others request a small fee (usually \$5 to \$10) in recognition of their efforts, or they may ask that you donate a similar amount to their favorite charity. A somewhat larger fee (anywhere from \$15 to \$50) is requested by some authors, in return for which they usually provide some sort of support—nothing as fancy as a toll-free hot line, mind you, but frequently such

things as notification of new versions and a willingness to answer cries for help. These minimal-charge methods of distributing software are sometimes called shareware or freeware.

The most important thing to remember, however, is that even if the author requests a fee, if you decide that you don't like or need the program after having experimented with it, you don't have to send a check. While I am on the subject of money, I should mention one other hidden expense of public-domain software that you should be aware of. Many programs are not self-running applications, but instead require that you use a language such as Microsoft BASIC (MS-BASIC) in order to run them. Since languages such as MS-BASIC are copyrighted, software authors cannot provide them along with the program in question. Thus, you must buy a copy of MS-BASIC, even if you don't know a thing about programming, to be able to run the programs that require it.

**S**ources of public-domain software abound, and you can obtain it in many different ways. Probably the most enjoyable method is simply to swap programs with friends and colleagues who have programs of interest to you. One of the

## BUY HARDWARE AND SOFTWARE AT WHOLESALE + 8% AND GET 14-30 DAY SOFTWARE RENTALS!..

In just the last few months, *The NETWORK* has saved its members more than \$24,000,000 and processed over 100,000 orders.

### The nation's largest corporations depend on PC NETWORK!

On our corporate roster are some of the nation's largest financial industrial and professional concerns *including some of the most important names in the computer industry:*

<b>AT&amp;T</b>	General Motors
Barclays Bank	Gillette
Bell & Howell	Hewlett Packard
Citibank	Hughes Aircraft
Columbia University	IBM
Data General	ITT
Exxon	Kodak
Farm Bureau Insurance	Multimate
Frontier Airlines	United Nations
General Mills	Yale University
General Electric	Veteran's Administration

plus thousands of satisfied consulting firms, small businesses, user groups, municipalities, government agencies and value-wise individuals ACROSS THE NATION! Their buyers know that purchasing or renting from PC NETWORK saves them time, money and trouble. They also count on us for product evaluation, professional consultation and the broadest spectrum of products and brands around.

**CALL TOLL FREE  
1-800-621-S-A-V-E**

In Illinois call (312) 280-0002  
Your Membership Validation Number: M575

You can validate your membership number and, if you wish, place your first money-saving order over the phone by using your VISA, MASTERCARD or AMERICAN EXPRESS. Our knowledgeable service consultants are on duty Mon-Fri 8 AM to 7 PM, SAT 9 AM to 5 PM CST.

**PERSONAL COMPUTER NETWORK**  
320 West Ohio  
Chicago, Illinois 60610

Call now...Join the PC NETWORK and start saving today!

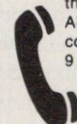

### PC NETWORK • MEMBERSHIP APPLICATION

**YES!** Please enroll me as a member in the PC NETWORK™ and rush my catalog featuring thousands of computer products, all at just 8% above DEALER WHOLESALE PRICES. I will also periodically receive "THE PRINTOUT", a special up-date on merchandise at prices BELOW even those in my wholesale catalog, and all the other exclusive, money-saving services available to Members.

575

I am under no obligation to buy anything. My complete satisfaction is guaranteed. Please check (✓) all boxes that apply:

**Basic Membership** With 14 Days Rental

- One-year membership for \$8
- Two-year membership for \$15 (SAVE \$1)
- Business Software Rental Library for \$25 add'l. per year—with 14 day rentals
- Games Software Rental Library for \$10 add'l. per year

**Special V.I.P. Membership\*** With 30 Days Rental.

- One-year membership for \$15
  - Two-year membership for \$25 (SAVE \$5)
  - BOTH Business and Game Software Rental Libraries for \$30 add'l. per year—with 30 day rentals
- \*VIP members receive advance notice on limited quantity merchandise specials

Bill my credit card:  VISA  MasterCard  American Express

Account Number:

Exp. Date \_\_\_\_\_ mo. \_\_\_\_\_ year

Check or money order enclosed for \$ \_\_\_\_\_

Name \_\_\_\_\_

Address \_\_\_\_\_ Apt. No. \_\_\_\_\_

City \_\_\_\_\_ State \_\_\_\_\_ Zip \_\_\_\_\_

Telephone (\_\_\_\_) \_\_\_\_\_

**Please provide the following information to insure compatibility with your system (check all boxes that apply):**

- APPLE //e  APPLE //c  APPLE //+  IBM-AT
- MACINTOSH  LISA  APPLE III  IBM PC

Other: \_\_\_\_\_

Signature \_\_\_\_\_

(Signature required to validate membership)

## FEATURED PRODUCTS

- BRAND NAME SSDD DISKETTES FOR APPLE II and III**  
Box of 10 Guaranteed for Life..... \$ 9.00\*
- CENTRAL POINT COPY II+ COPY II-MAC** ..... 20.00\*
- EPSON PRINTERS Unbelievable Low Prices!!!**
- LX-80 80COL/100CPS ..... 217.00\*
- FX-80 80COL/160CPS ..... 316.00\*
- FX-100 132COL/160CPS ..... 449.00\*
- MONOGRAM DOLLARS & SENSE for Apple II+ /E and Mac** ..... 57.00\*
- LIVING VIDEOTEXT Think-Tank + /E/MAC** ..... 75.00\*
- HAYES MICROMODEM IIe** ..... 125.00\*  
With Smartcom I
- AMDEK MONITORS**
- V300G Composite Green ..... 110.00\*
- V300A Composite Amber ..... 120.00\*
- IBM PC 256K HARD DISK SYSTEM** ..... 1,886.62\*
- 1-320K Drive/1-10MB Hard Disk/256K CPU
- COMPAQ PORTABLE HARD DISK SYSTEM** ..... 2,375.00\*
- 10MB/1 Floppy/256K
- HAYDEN ENSEMBLE** ..... 155.00\*  
1st integrated package for the MAC
- BRAND NAME MACINTOSH DISKETTES** ..... 24.95\*  
Box of 10 Guaranteed for Life. Includes free Flip & File Case

\*NETWORK Members pay just 8% above these wholesale prices plus shipping.

## Complete Apple Systems

The NETWORK offers fantastic discounts on these three complete Apple packages.

### ▶ APPLE //c

- 128K System
- Modem Port
- Serial Printer Port
- Mouse/Game Port
- Composite/RGB/TV
- 40/80 Column
- Monitor Port
- QWERTY/DVORAK
- Keyboard
- Built in Drive
- Software

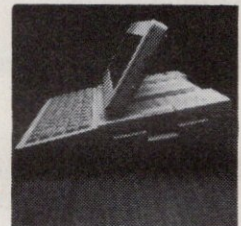

TOO LOW TO PRINT!

### ▶ APPLE //e PROFESSIONAL SYSTEM

- 128K //e CPU
- 80 Column Card
- 2 Disk Drives
- Software



TOO LOW TO PRINT!

### ▶ MACINTOSH BASE SYSTEM

- 192K Memory
- 400K Diskette
- Keyboard
- Mouse
- Software



TOO LOW TO PRINT!

Wholesale Prices Change Rapidly... if you ever see a lower price advertised anywhere please call! You will find the Network's Price will always be the best!



## ...AS A PC NETWORK MEMBER ONLY!

Listed below are just a few of the over 20,000 products available at our EVERYDAY LOW PRICES!

### GAMES & EDUCATIONAL SOFTWARE

(Please add \$1 shipping and handling for each title ordered from below.)

	Wholesale	Wholesale
Bluechip Barron, <i>Milionsaire or Tycoon</i>	\$ 28.25*	\$ 28.97*
Broderbund Loadrunner	19.75*	20.97*
Broderbund Chopflifer	19.00*	39.88*
Broderbund Print Shop	28.75*	21.00*
CBS Goren-Bridg	45.00*	18.00*
CBS Mastering the SAT	81.00*	28.25*
CBS Wizard By The Dozen	20.97*	28.50*
Davidson & Associates Speed Reader II	37.97*	20.00*
Davidson & Associates Math Blaster	29.97*	15.97*
Davidson & Associates Word Attack	29.97*	24.97*
Epy Temple of Apschal	21.97*	15.97*
Hayden DaVinci—Houses/Interiors or Landscapes— <i>Mac Only</i>	29.97*	15.97*
Hayden Sargon III	28.47*	15.97*
Hayden-SAT Sampler Test	11.97*	15.97*
Infocom Deadline	28.00*	20.77*
Infocom Enchanter, Planet Fall, Seastaker, Zork I	22.00*	29.40*
Infocom Sorcerer, Zork II	25.00*	31.00*
Infocom Suspended	28.00*	21.00*

### BUSINESS SOFTWARE

(Please add \$2.50 shipping and handling for each title ordered from below.)

	Wholesale	Wholesale
ATI How to Use Multiplan	\$ 42.00*	\$102.25*
Borland International Turbo Pascal	30.00*	102.25*
BPI GL, AP, AR, FR, or HW Each Only	211.50*	85.00*
Broderbund Bank Street Writer	40.00*	66.25*
Central Point Copy II Plus	20.00*	105.00*
Dow Jones Software Market Analyzer	198.00*	52.00*
Dow Jones Software Math Manager	171.00*	85.00*
Funk Software Sidways	35.00*	237.00*
Howardsoft Tax Preparer 1985	150.00*	67.50*
Living Videotext Think-Tank Mac-Too!	75.00*	125.00*
Human Edge Mind Prober	28.50*	69.00*
Human Edge Management of Sales Edge	138.00*	89.00*
Human Edge Communication Edge	98.00*	69.00*
Mark of the Unicorn Mouse Stampede	23.97*	199.00*
Microsoft Multiplan (DOS or CP/M)	105.00*	29.97*
Microsoft Word for Macintosh	102.25*	71.50*
Microsoft File for Macintosh		
Microsoft Multiplan for Macintosh		
Microsoft Basic for Macintosh		
Microsoft Chart for Macintosh		
Microsoft Crosstalk		
Monogram Dollars & Sense		
Monogram Dollars & Sense for Macintosh Version Only		
Odesta Helix for Macintosh Reg's 512K		
Sensible Software Sensible Speller IV		
Softcraft Fancy Fonts		
Software Publishing PFS File		
Software Publishing PFS Write		
Software Publishing PFS Graph		
Stonerware DB Master Version—Mac-Too!		
TMaker Click Art for Macintosh Version Only		
United Software Ind. Ascii Express Pro		

### HARDWARE

(Please add shipping and handling charges found in italics next to price.)

COMPLETE SYSTEMS		BOARDS AND BUFFERS	
Apple Macintosh Base System	CALL	ALS Z-Engine	\$ 129.00* (2/50)
Apple Apple IIe	CALL	AST Research Multi I/O-2 Serial/Clock	165.00* (2/50)
Apple Apple IIc	CALL	Microsoft Premium Software Kit	243.67* (2/50)
Columbia Desktop & Portable Systems	CALL	Microtek Dumping I/O	55.00* (2/50)
Compaq 4 Models	CALL	Microtek Magnum 80 Col + 64K	93.00* (2/50)
COMPAAQ Hard Disk Portable	\$2,375.00* (51 00)	Orange Micro Grappler +	96.90* (2/50)
10MB Hard Disk I Floppy/256K		Orange Micro Serial Grappler	78.00* (2/50)
DATA General DG ONE	1,999.00* (43 20)	PC Network 280 Card	35.00* (2/50)
128K I Drive The Real Portable*		Personal Comp Prod 64M Appli-Card	552.00* (2/50)
IBM PC Base System 256K/PC/256K	1,495.92* (32 55)	Quadram MP-8K Microdotz Buffer (expandable)	110.00* (2/50)
IBM PC Professional Hard Disk	1,886.62* (40 75)	Quadram APIC Parallel Interface	57.00* (2/50)
1 (256K/PC/10MB Hard Disk/256K)		Quadram APIC/G Graphics Interface	82.00* (2/50)
IBM PC/AT All Configs	CALL	Quadram 68-AM-80-80 Col with 64 Memory	88.00* (2/50)
Seyno 486™ Local Memory Cost Compatible*	620.00* (13 39)	Street Electronics CPHO II Speech Synthesizer	100.00* (2/50)
Seyno MBC 775 Color Portable IBM Clone	1,775.00* (38 00)	Thunderware Thunderclock	104.00* (2/50)
2 Drive/Color Monitor/256K			
Tava PC Complete IBM Compatible	1,200.00* (25 92)		
(256K/2 Drives)			

### PRINTERS

Texas Instruments Professional	CALL	Apple 15" Imagewriter Requires Kit	\$ 530.00* (11 45)
		Apple 8 5" Imagewriter Requires Kit	446.00* (9 34)
		C. Itoh Starwriter F10 40 CPS LQ	875.00* (18 90)
		Epson 100 CPS 80 COL LQ Mode— New Model!	517.00* (14 75)
		Epson FX-80 160CPS 80 COL	318.00* (6 90)
		Epson FX-100 160CPS 80 Col Printer	449.99* (9 35)
		Epson LQ1500 NEW LQ/DP Printer	875.00* (18 90)
		Epson Apple-to-Epson Parallel Cable	21.00* (1 00)
		NEC 2030 20CPS Letter Quality Printer	605.00* (13 74)
		NEC 3530 33CPS Letter Quality Printer	960.00* (20 70)
		Okidata 486 Serial & Parallel	290.00* (7 00)
		Okidata ML 152 New 140CPS/LQ Model/FRICT	200.00* (4 34)
		Epson Graphics	55.00* (2 50)
		Okidata NEW Color 30 90CPS/100 + Colors	109.00* (4 34)
		Okidata Micro/Epson Graphics + More Requires Interf	69.00* (1 40)
		Okidata NEW Epson Interface	34.00* (7 35)
		Okidata ML 152 New Steek Design/160CPS/	60.00* (7 35)
		Q Micro/Print/IBM Graphics	20.75* (1 00)
		Okidata Apple-to-Epson Parallel Cable	396.00* (8 55)
		Quadram Quadlet Multicolor Ink-Jet with Kit	1,155.00* (24 40)
		Queme Sprint 11445 45 CPS Letter Quality	72.00* (2 00)
		Queme IBM Cable and Interface (required)	290.00* (6 35)
		Silver Speed 510P 520 120PS Letter Quality	540.00* (12 00)
		Talley MT-160L 160CPS DPLQ Printer	679.00* (14 70)
		Texas Instruments 855 DPLQ w/Tractor	530.00* (11 50)
		Toshiba P-1340 80 Col version of P-1351	

### ACCESSORIES AND SUPPLIES

Brand Name Macintosh Diskettes	\$ 24.95* (1 00)
Box of 10 Guaranteed for Life Includes Free Flip & File Case	
PC Network SSD Diskettes (Box of 10)	9.00* (1 00)
Chalkboard Powerpad	62.00* (1 50)
Kensington Microwave System Saver Fan	56.97* (1 50)
Koala KoalaPad Touch Tablet	78.00* (1 40)
Hayes Mach II Joystick for file	25.00* (1 50)
Hayes Mach III Joystick w/Free Button for file	31.00* (1 50)
M & R Sup-R-Mod RF Modulator	44.00* (1 50)
Apple Macintosh Carrying Case	74.00* (1 60)
Micron Micron Eye	275.00* (5 94)
PC Network Cooling Fan with Surge Protector & Dual Outlets	25.00* (2 50)
Thunderware Thundercam Optical Digitizer No Expensive Camera Equipment Needed!	165.00* (2 50)
WP Printer Paper 2600 Sheets Microline Perfs Mac-Too! Indicates the Mac version is available at the same price.	17.00* (1 00)
*PC Network Members pay just 8% above the wholesale price, plus shipping. All prices reflect a 3% cash discount. Wholesale prices fluctuate rapidly—all prices in this issue have been prepared 60 days in advance. Please call for latest prices. Minimum shipping \$2.50 per order. International orders call for shipping & handling charges. Personal checks please allow 10 working days to clear.	

### MEMORY CHIPS

All chips guaranteed for life.

64K Memory Upgrade Kits (9 chips)	\$ 8.55* (1 00)
64K Dynamic Ram Chips (Each)	.95* (1 00)
Anchor Volkmodelm	\$ 47.00* (2 50)
Anchor Mark XII LOWEST PRICE 1200BPS HAYES COMPATIBLE EXTERNAL MODEM!	230.00* (5 00)
Hayes Micromodem IIe w/Smartmod	125.98* (2 53)
Hayes Smartmodem 300	129.00* (5 00)
Hayes Smartmodem 1200BPS with new Smartcom II, VT 100 Emulator	320.00* (2 50)
Novation Apple Call II	174.45* (2 50)
Prometheus ProModem 1200	279.90* (6 00)
Prentice Pop Com MAC Pack	322.00* (2 50)
1200 Baud Modem, Cable, Straighttalk	102.00* (2 20)
U.S. Robotics Password	195.00* (4 00)

### MONITORS

Amdel Video 300G Composite Monitor	\$ 110.00* (3 00)
Amdel Video 300A Composite Monitor	120.00* (3 00)
Amdel Video 310A IBM Type Monochrome Monitor	130.00* (3 00)
Amdel Color 300 Composite Color	215.00* (6 00)
Amdel Color 500 RGB Color	320.00* (6 00)
Princeton FX-12 RGB Monitor	CALL
Taxan 210 Combination RGB/ Composite Display	230.00* (6 00)
Zenith ZVM-123 High Res Green (Consumer Reports Rated Best Buy!)	78.00* (2 50)

## ...WITH THESE 15 UNIQUE BENEFITS

**1 COST + 8% PRICING**—The NETWORK purchases millions of dollars in merchandise each month. You benefit in receiving the lowest price available and all at just 8% above published dealer wholesale price.

**2 OUR 600 PAGE WHOLESALE CATALOG**—Members receive our 600 page wholesale catalog containing over 20,000 hardware and software products for the IBM PC, APPLE and over 50 other popular computer systems. THE NETWORK'S CATALOG IS THE LARGEST SINGLE COMPILATION OF PERSONAL COMPUTER PRODUCTS AVAILABLE TODAY. NOW UPDATED QUARTERLY!

**3 IN-STOCK INSURED FAST HOME DELIVERY**—The NETWORK maintains a giant multi-million dollar inventory of most popular products, allowing us to ship many orders from stock. Non-stock items are typically maintained in local warehouses just days away from THE NETWORK and YOU. We pay all insurance expenses on your shipment. EMERGENCY OVER-NIGHT SERVICE IS AVAILABLE ON REQUEST.

**4 10 DAY RETURN POLICY**—If you are not satisfied, for any reason with any hardware component purchased from THE NETWORK within 10 days of receipt, we will refund your entire purchase (less shipping) with no questions asked.

**5 MEMBERSHIP SATISFACTION GUARANTEE**—If for any reason you are not satisfied with your membership within 30 days, we will refund your dues IN FULL.

**6 EXPERIENCED CONSULTANTS**—The NETWORK hires consultants, not order takers, to aid you in product selection. Our consulting staff possesses in excess of 150 man years of personal computer product experience. We back our consultants with our money back guarantee: IF ANY PRODUCT RECOMMENDED BY OUR CONSULTING STAFF FAILS TO PERFORM AS PROMISED—WE WILL TAKE IT BACK AT OUR EXPENSE FOR A 100% REFUND.

**7 FREE TECHNICAL SUPPORT**—The NETWORK supports every product it sells. Our qualified TECH-SUPPORT staff will help you assemble your system, interpret vendor documentation and get your software and hardware to work. WE WILL GIVE YOU ALL THE HELP YOU NEED, WHEN YOU NEED IT—FREE!

**8 OPTIONAL BUSINESS RENTAL LIBRARY**—All members can join our BUSINESS RENTAL LIBRARY featuring over 1000 available titles for just \$25 PER YEAR above the base membership fee. This entitles you to rent business software AT JUST 20% of the DISCOUNT PRICE FOR A 14 DAY PERIOD. If you decide to keep the software, the entire rental fee is deducted from the purchase price. VIP MEMBERS GET A FULL 30 DAYS for just \$30 above the V.I.P. base fee. This also includes the game library privileges for a \$5 combination savings.

**9 OPTIONAL GAME SOFTWARE RENTAL LIBRARY**—The Game Rental library is available to members for just \$10 PER YEAR and permits evaluation (or just enjoyment) of any game or educational software product as above.

**10 SPECIAL SAVINGS BULLETINS—THE PRINTOUT**—Issued Quarterly at no charge to Network members only! The Printout contains all the New Product listings and price changes you need to keep your Catalog up to date. Also, we buy excess dealer inventories, and store bankruptcy closeouts, which we turn around and make available to our members at fantastic savings via THE PRINTOUT.

**11 DISCOUNT BOOK LIBRARY**—Working with numerous publishers and distributors, THE NETWORK has assembled a library of over 1000 computer related books and manuals at savings of up to 75% from the normal store price.

**12 MEMBERSHIP REFERRAL BONUS**—Our most valuable source of new members is you! To date almost 40% of our members have been referred by word of mouth from other satisfied members. For those of you who refer new members, THE NETWORK will credit a cash bonus to your account applicable to any future purchase.

**13 CORPORATE ACCOUNT PROGRAM**—Almost 50% of The NETWORK's members are corporate buyers and users (see opposite page left). The NETWORK can establish open account status and assign designated account managers to expedite orders, and coordinate multiple location shipments.

**14 QUANTITY DISCOUNTS**—For large corporations, clubs, and repeat or quantity buyers THE NETWORK can extend additional single order discounts, when available to us from our manufacturers and distributors.

**15 PRICE PROTECTION**—The PC Industry is crazy!! Prices change not yearly or monthly or even weekly but often day by day! These changes are sometimes up but are mostly down!!! THE NETWORK GUARANTEES THAT IN THE EVENT OF A PRODUCT PRICE REDUCTION, BETWEEN THE TIME YOU PLACE YOUR ORDER AND THE TIME THE PRODUCT SHIPS YOU WILL ONLY PAY THE LOWER AMOUNT!!

CALL TOLL FREE 1-800-621-S-A-V-E (orders and membership only)

In Illinois call (312) 280-0002 validation M575

CIRCLE 315 ON READER SERVICE CARD

benefits of this approach is that your associates have probably already tried the software and may have some advice or warnings to offer. Not everyone has such valuable friends, however, and for those of us who don't, there are many other sources of public-domain software.

Users' groups often maintain a library of public-domain software for their members. The programs are usually available on a series of disks. You decide which programs you want and then purchase the disks that contain them, either at a group meeting or through the mail. NYMUG (New York MacUsers' Group), for example, has seven disks of programs available (as of this writing). As with most software from such libraries, the programs on the NYMUG disks are not organized in any coherent fashion. Usually users' groups charge for these disks (NYMUG asks \$8) to cover the cost of the disk, duplication, and order processing. Since such software libraries expand constantly, it pays to check every month or two to see if new disks are available.

Some public-domain software is available from the author through the mail, usually for a small fee (\$5 or so).

The advantage of acquiring a program this way is that you can be sure of getting the most recent update, a complete documentation file, and possibly some goodies that are missing from freely circulating copies. The disadvantage is that it takes time.

Speed demons who can't wait for

their friends or the mail can acquire public-domain software electronically. Some electronic bulletin-board systems (BBSs for short) are run by generous individuals, others by clubs for the benefit of their members. In addition to files of news, gossip, and help, many BBSs have a section de-

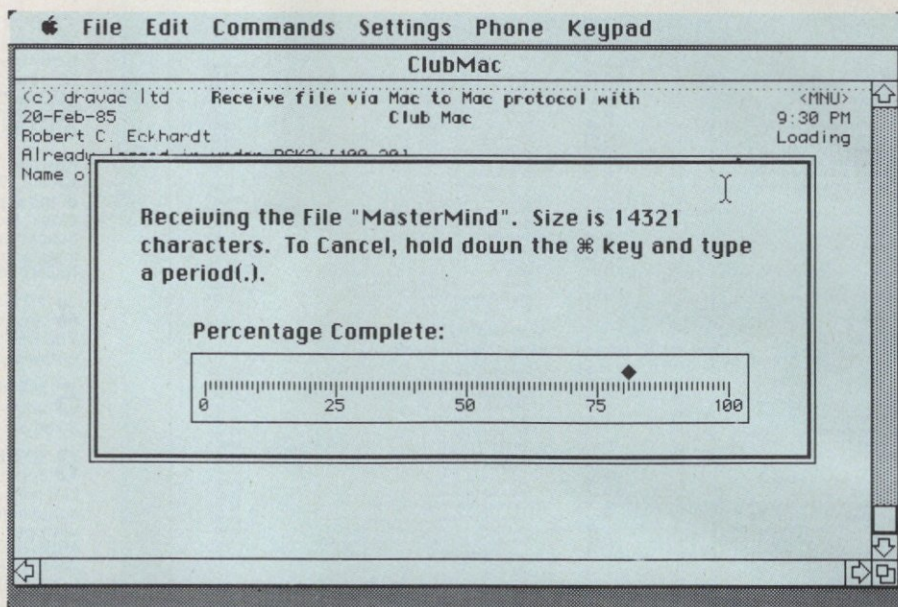
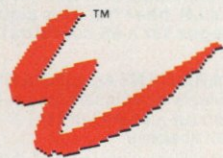

Figure 1: When you download files from the Club Mac BBS using MacTerminal and VT-100 emulation, a ruler-like meter shows you how the transfer is progressing.



+



=

AI

**ExperTelligence™** has the "tools" to transform your Macintosh™ into a powerful Artificial Intelligence workstation. **ExperLisp™** is the first complete implementation of LISP on a microcomputer. Developed on a Symbolics 3600,™ the compiler generates efficient MC68000 code providing speed and function ideal for the development and delivery of sophisticated AI applications. **ExperOPS5™**, by Science Applications International Corporation, is a complete implementation of the well-known OPS5 expert systems building tool. It provides a fast and efficient method for constructing complex Expert Systems.

**ExperLogo™** features 3-D and spherical graphics, English-like commands and shares the speed and function of ExperLisp. In the classroom or in the lab, ExperLogo provides an environment for discovery and exploration for children and developers alike.

Call today for more information about these and other innovative AI products.



ExperTelligence, Inc.  
559 San Ysidro Road  
Santa Barbara, CA 93108  
Tel: 805/969-7871.

Macintosh is a trademark licensed to Apple Computer, Inc.  
Symbolics 3600 is a registered trademark of Symbolics, Inc.

voted to public-domain software, which you can download (transfer) from the BBS to your disk drive via a modem, the phone lines, and the appropriate software. If you already own a modem and the software to use with it, and if your area has a BBS, you can acquire public-domain software quickly for no more than the cost of a local phone call.

One of the best BBSs for people interested in public-domain software is run by Club Mac, a national users' group located in Houston, Texas. Although Houston is not a local call for most people, this BBS is well worth exploring for those who have the necessary communications software. Club Mac is in the process of converting to a Uninet hookup with an hourly charge, so by the time you read this, the call may in fact be free—and the hourly rate will probably be lower than that of most long-distance calls. (See figure 1, a sample Club Mac screen that shows a file transmission in progress.)

Many public-domain programs that are available on BBSs were originally copied (or are also available) from a single important source: the section of CompuServe called the Micronet Apple User's Group. CompuServe has many sections, of course, of which MAUG is just one, but MAUG is one of the most active areas of CompuServe, and it contains perhaps the largest and most fascinating library of public-domain software anywhere.

**Y**

ou have to pay a membership fee to join CompuServe, and you must pay an additional hourly rate for the time you spend on-line. Unless you live out in the sticks, however, you can reach CompuServe through a local telephone number that connects to one of several possible nationwide access networks. Thus, for most people, the call itself is not a major expense, and once you learn your way around CompuServe, the cost of exploring for and downloading public-domain software is not unreasonable.

Although many public-domain application programs are available for the Mac, they vary widely in quality. Some of these programs do perform functions currently unavailable in

commercial form, though.

Take Screen Maker 1.0 by Bill Atkinson, for example. This small (6K) and simple program converts the upper-left portion of a MacPaint document into a new opening screen that you can place on any start-up disk. Thus, if you are tired of Welcome to Macintosh, you can replace it very easily with, say, Beam me up, Scotty. You can also convert an existing start-up screen to a MacPaint document in order to alter it according to your taste and then convert it back again.

The program has no documentation, but its operation is essentially self-explanatory. All you need to do is convert any existing start-up screen back to MacPaint to determine exactly which part of a MacPaint document the program uses.

Another public-domain program is important if you download programs from MAUG or a BBS. Many files are converted to a special format for transmission via modem and the phone lines. If you download such a converted file (they usually have a



# Mac COVER UP

Your Macintosh is not just a computer. It's a part of your business and a part of your life. It's just like family, and it deserves the *best* of care. So put on a 'COVER UP' and see how great your Mac will look while being protected from dust and spilled liquids. 'COVER UPS' are custom designed to fit like a glove, and yet allow very easy access to your Mac. With our 'COVER UPS', you can arrange your hardware any way you like. An individual 'COVER UP' is available for each component in your system. So after a long day with Mac, you won't have to rearrange your hardware when you shut down. Just 'COVER UP'. Save time, and save your Mac, in one of seven beautiful colors, from tan to blue to bone (same as the color of the Macintosh).

Set #	Contents	Sug. Retail*	Set #	Contents	Sug. Retail*
<b>MACINTOSH SETS</b>			<b>APPLE IIc SETS</b>		
#M1	Macintosh, KYBD, Mouse, Imagerwriter	\$29.95	#C1	Apple IIc KYBD and Monitor	\$18.95
#M2	Macintosh, KYBD, Mouse, Imagerwriter, and Ext. Disk Drive	\$31.95	#C2	Apple IIc KYBD, Monitor, and Ext. Disk Drive	\$24.95
#M4	Macintosh, KYBD, Mouse, Imagerwriter, Ext. Disk Drive, and Numeric Ten Key	\$32.95	<b>APPLE IIe SET</b>		
<b>MACINTOSH XL SETS</b>			#E1	Apple IIe KYBD, Monitor, and Ext. Disk Drive	\$25.95
#L1	Macintosh XL with Profile Piggyback	\$25.95	#E2	Pro Model with Duodisk	\$25.95
#L2	Macintosh XL 2/5, 2/10	\$23.95	*Shipping and Handling UPS ground add \$3.00		
			*Shipping and Handling UPS 2nd day air add \$4.00		
			*We accept Visa and MasterCard		

These are just a few of the 'COVER UPS' available. For a complete product list circle reader number below, or call in order and receive special A+ readers discount.



## Computer Cover Co.

P.O. Box 3080, Laguna Hills, CA 92654  
CA (714) 380-0085 Others (800) 235-5330

Dealer Inquiries  
Invited

Macintosh, Apple IIe, IIc, Mac XL are all registered trademarks of Apple computer.

**NEW PRODUCT** Now you can take it with you, your diskettes that is. New 'SOFT PAK' makes it possible. Attractive pocket size (3 1/2") diskette carriers. Two sizes available now. 4 or 6 Pak.

CIRCLE 163 ON READER SERVICE CARD

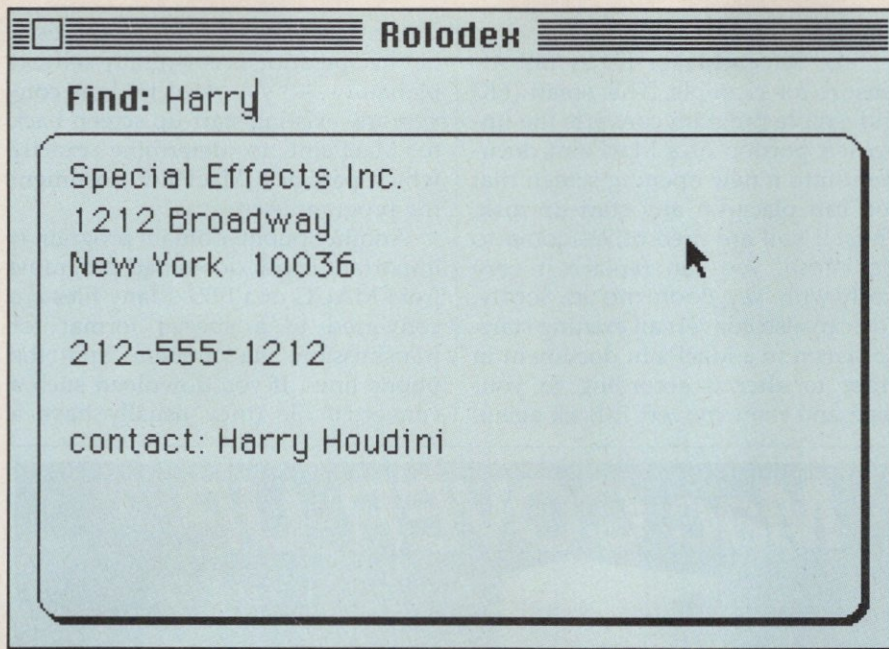
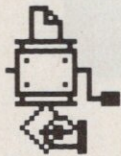

Figure 2: When you use the Find command, Rolodex will locate all cards with the requested search string (name, number, and so on), no matter where the string is located on the card.

three-letter code—either hex, hcx, or hqx—after the filename), you must then reconvert it in order to use it. BinHex 4.0 by Yves Lempereur takes care of this conversion amazingly quickly and efficiently. For example, a file that takes 20 minutes or more to download, once you choose it by selecting Upload Application from BinHex's File menu and then double-clicking on its name in the resulting dialog box, is converted and ready to go in seconds.



BinHex

Banner by John Gregory prints long linear signs on the Imagewriter. Because the program simply blows up individual pixels into large squares or circles (your choice), the results look best from a distance. Fonts that come in 36-point sizes work best if you want your letters to fill the width of the paper (which is, of course, the height of the banner). The Cairo font also works well at 36 points (since that is an even multiple of Cairo's true size, 18 points).



Banner

Mixing pictures and text into one long masterpiece requires a little sleight of hand, since each individual banner can handle only one font. All you need to do, however, is print several single-font segments in sequence, taking care to override the form feed (by rolling back the print-out), should any segment end in the

middle of the page.

If you have difficulty controlling the buildup of notes you take on odd scraps of paper, then Rolodex by Bill Atkinson may be the answer to your problems. It acts almost like a real Rolodex, except that it can flip through cards far faster than any human can. It also can search the cards for any word or group of words, regardless of where on the card they might appear (see figure 2). It doesn't do anything fancy such as dial the phone number it just found, but you can use it to keep track of all kinds of notes, not just addresses and phone numbers.



File

File 1.0 by Cary Clark is a simple text editor that permits only one predefined font in a single size and style. What you lose in looks, however, you gain in speed, and by being able to open more than one window at a time. All of these attributes make File especially appropriate for use in conjunction with programs such as the Red Ryder terminal program (see page 111) that require that you write dialing procedures and macro definitions with a separate editor and then save them as text only (see figure 3).

Another version of Clark's File, called 1.UTAH, allows for three fonts in two point sizes, as well as a few format options. This version makes for a nice demonstration of multiple windows, but the simpler version is more useful as a stripped-down text editor.

If the sluggishness with which MacWrite reformats or searches large documents is a source of irritation (it certainly is for me), then Edit by Bill Duvall may be an appropriate cure. After what seems like hours of wait-



Edit

ing for MacWrite to convert a large document from 9-point Monaco to 12-point New York, the speed with which Edit performs the same tasks is difficult to believe. Like File, it also lets you use multiple windows (al-

*(continued on page 113)*

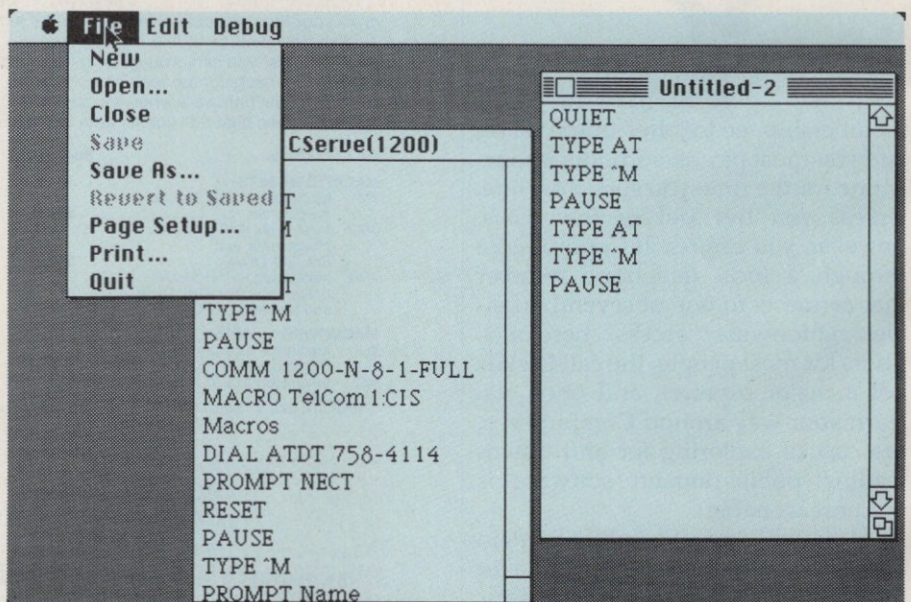

Figure 3: File 1.0 allows you to open several windows at once, so you can use one window as inspiration for what you are writing in the other. You can also copy and paste directly from one window to another.

# JUST ARRIVED!

## The first complete desk management program for the Mac.

It's here! A powerful software program featuring dynamic storage/retrieval capabilities for your Mac. It's called THE DESK ORGANIZER®. And it's ready to help you organize yourself, your work, you name it.

At the core of THE DESK ORGANIZER is a *free-form filing system* that files anything you want, just by typing it. Notes. Letters. Reports. Phone numbers. Names and addresses. And you can retrieve or update at any time.

Surrounding this system are easy-to-use tools that add a new dimension to your Mac:

THE DESK ORGANIZER's *extensive correspondence facility* replaces Mac's limited notepad. Its *calculator* adds an electronic paper tape—and a powerful formula calculator (the Mac has neither). And THE DESK ORGANIZER offers *unlimited alarms* that chime gently to remind you of meetings. Plus a *telephone dialer* that automatically searches files, locates the proper number and connects you.

What's more, THE DESK ORGANIZER increases the filing capacity of the Mac—by storing hundreds of Mac notes and letters on a single diskette.

Born to run on the Mac, THE DESK ORGANIZER can *co-reside with other Mac programs*—to keep you completely organized no matter what you're working on.

To get this infallible electronic secretary for **only \$99**, see your Mac software dealer.

**OR CALL WARNER SOFTWARE (212) 484-3070.**



Warner Software, Inc., 666 Fifth Ave., New York, NY 10103  
A Warner Communications Company

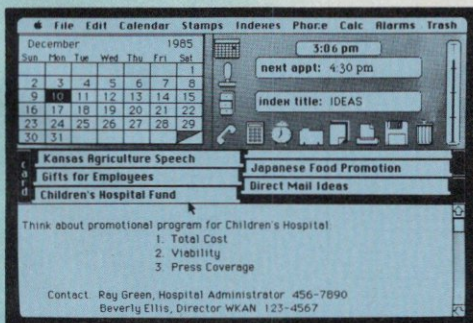

**INCLUDED FREE:** 25 business form letters and a library of useful formulas. Runs on 128K and 512K Macs.

### Truly a major software breakthrough!

Macintosh® is a registered trademark of Apple Computer, Inc. The Desk Organizer® is a registered trademark of Conceptual Instruments Company. Come see us in booth 522 at the Mac World Expo in Boston, August 21st–23rd.

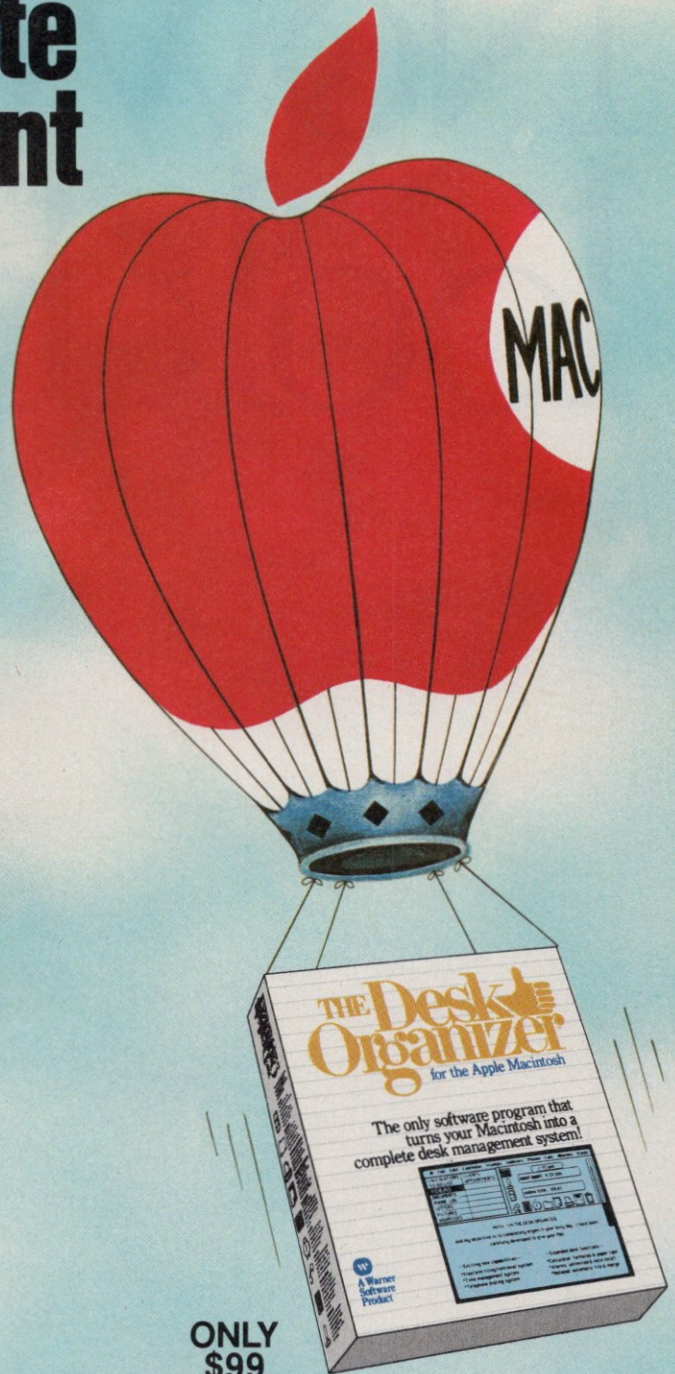

**ONLY \$99**



CIRCLE 193 ON READER SERVICE CARD

# Now data de look base.

 The Spokesman

PRICE LIST  
Effective January, 1985

Number	Product Description	Price
45	Water Bottle	15.00
L	Ladies 26" Breeze 10 Speed	179.00
0	Bicycle Built For Two	249.00
00		69.00

 The Spokesman STOCK BOOK

Description: Handlebar Tape  
Item Number: HT100  
Closing Stock: 10  
Current Inventory Date: March 31, 1985  
Understocked by: -2  
Comments: Available in brown, red

Last Inventory Date: January 10, 1985  
Reorder Point: 8  
Vendor: MiracleTape Inc.  
Address: 66 Tacky Drive, Stickyville, MA 01701

To: Acme Water Bottle Sales  
2389 E. Salem Drive, Kiokuck, Iowa 23668

To: American Bicycle  
234 Main Street, Philadelphia, PA 03456

To: MiracleTape Inc.



The Spokesman

12 Bearing Street Wheeling, W.VA 26055

March 6, 1985

Jeremy Williamson, Jr.  
1456 East Raybourne Road  
Farmville VA 23944

Dear Jeremy:

Thank you for your recent order from the Spokesman Company. We are currently processing your order for immediate shipment. The following list represents the totals we have received in our shipping department.

2	27" alloy wheel	# 27AW	at	\$62.00	\$124.00
1	Seat Post	# 5792	at	\$22.78	\$22.78
4	Brake Shoes	# BBS200	at	\$3.00	\$12.00
2	Saddle Bags	# SB 231	at	\$38.00	\$76.00
<b>Total Order:</b>				<b>\$234.78</b>	

I am confident products for you free number if modify the or telephone price adequate notice

Thank you again in the

Sincerely,

John L. Sp

 The Spokesman PURCHASE ORDER

To: Weinmann, USA  
88 Skid Row  
New York, NY, 01103

Description	Item Number	Units	Unit Price	Extended Price
Brake shoes	BBS200	2	\$0.50	\$1.00
Brake lever, right front tire	BBA101	1	\$5.45	\$5.45
Brake lever, left front	BBA102	2	\$5.45	\$10.90

Amount of Purchase order: \$17.35  
Sales Tax: \$1.12  
Total Amount of Purchase order: \$18.47

**Totals for Acme Water Bottle Sales**

Description	Item Number	Unique Items	Units in Stock	Reorder units	Under Stocked
Water Bottle	AC 2345	1	8	4	
American Bicycle	Ladies 26" Breeze	AB26L	3	-1	\$9
American Bicycle	Bicycle Built For Two	AB200	4	8	\$135
American Bicycle	Solo Unicycle	AB100	5	1	\$49
American Bicycle	Mens 27" Blazer	AB27M	3	1	\$99.0

**Totals for American Bicycle**

Description	Item Number	Unique Items	Units in Stock	Reorder units
Handlebar Tape	HT100	4	15	9
Chrome forks for 27"	FCA911	1	10	-2
Red Flyer Bike	FCA901	2	1	-2

**Totals for Miyaka Bicycle**

Description	Item Number	Unique Items	Units in Stock	Reorder units	Total Restock Cost
Shim		2	6	2	\$5.95
		5	1	1	\$78.85
		3	3	3	\$84
		3	3	3	\$15.95
		10	3	3	\$1.75
		49	7	7	\$14.65
					\$5.25
					\$43.95
					\$65.15
					\$1,330.81

# esn't have to

## Introducing FileMaker.

Because just *having* information isn't enough. You have to be able to do whatever you want with it. Arrange it. Rearrange it. Massage it.

Embellish it. Make it into something you can use. Easily.

FileMaker™ lets you not only store and organize your business information, but manipulate it in limitless ways, to create literally any kind of form or report you want.

First of all, FileMaker lets you change direction, any time, without redoing everything. It even lets you start out without a direction.

And in addition to doing all the meat-and-potatoes things a database is supposed to do—calculations, summary reports, sorting of all kinds—FileMaker does everything you bought your Macintosh™ for. Text editing. Graphics. Pull-down menus. Keyboard commands. Windows. Different fonts, styles and graphic design tools. Your information not only makes more sense, it makes an impression. Any kind you want.

With FileMaker, you can even design your own data entry forms, so

you can put information *in* any way you want, without arbitrary limitations. And of course, it does all the tricky little things automatically... like indexing every word, number and date for speed searches.

Because you design your output right on the screen, you can see exactly what you (and your customers) are going to get. And you can create any number of forms for your information to take.

So what might have been a dreary order acknowledgement can now be a clear, friendly letter. Or it can be a meaningful comparison of inventory by vendor. Or parts lists, receiving verifications, purchase orders, labels, name badges, rosters and hit lists.

With FileMaker, you can pick up from other programs, like MacWrite™, MacPaint™, MicroSoft Plan™, Jazz™ and share the applications you've created with other members of your team. You get all the tools you need to easily consolidate group efforts into one database.

And FileMaker takes full advantage of the Macintosh family, including the Macintosh XL™, Macintosh Office™ and LaserWriter™.

So for \$195 (suggested retail), things could look considerably better for your entire division, department,

professional practice, retail operation, club, organization, or principality.

Contact your Macintosh software dealer for a demonstration, or call 1 800 MACWARE to find out where you can get FileMaker in your area. From Forethought, Inc.

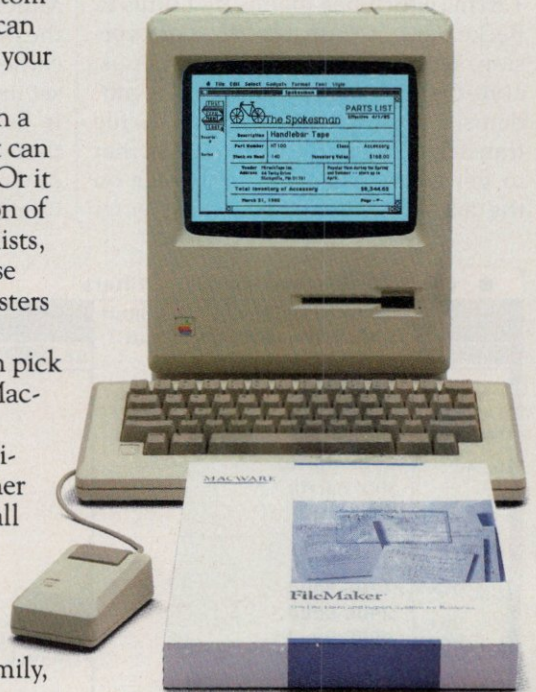

## MACWARE™

# PUBLIC-DOMAIN COMMUNICATIONS PROGRAMS

The list of public-domain communications programs and their origins reads like a biblical genealogy (so-and-so begat such and such, and they had ten children, and so on). Just as in the Bible, though, the family tree may contain a lot of names, but only a few play an important role. Thus, if you are in the market for a communications program, I suggest you look at one or more of the following better-known relatives first.

MacTEP by Dennis Brothers is one of the truly venerable public-domain communications programs for the Macintosh. For good reason, too—in its many versions, it remains fairly simple, predictable, and reliable. MacTEP was first published in the May 1984 issue of *A+*, and an improved and corrected version appeared in "MacTEP Revisited" (*A+*, July 1984, pages 93–97). For people who are new to telecommunications and have MS-BASIC 1.01, MacTEP 1.81m (which has menus by Loftus E. Becker, Jr.) is probably the best version, with its straightforward menus, auto-dial for Hayes-compatible modems, and simple (straight ASCII) file transfers. The only tricky part is that to get phone numbers to appear on the auto-dial menu, you must enter

them into the program listing (between lines 5030 and 5100) before running the program. Entering these numbers isn't particularly difficult; the trick is not to attempt to enter them directly onto the auto-dial menu.

## B

ASIC 1.01 owners who want a few more features than are offered in MacTEP should try one of the following variations on Brothers' and Becker's original handiwork: AutoTEP.vs2, with third coauthor Michael McKay; Auto MacTEP Mouse 1.87, which adds a fourth coauthor, Jim Aliff to the list; and TEP Plus, by Brothers and Gary R. Voth.

For those who have MS-BASIC 2.0, RLMTEP 3.0, a rather extensive modification of MacTEP by Ralph L. Miller, is the one to try first. Because the documentation was written for an earlier version of RLMTEP, getting it set up properly can be a bit confusing. It is definitely worth the effort, though. RLMTEP has its own pull-down menus and thus looks and acts more like a stand-alone application

than a BASIC program. Another major enhancement over MacTEP is that it not only dials but also logs automatically onto services such as CompuServe. As with MacTEP, however, only ASCII file transfers are possible.

Getting RLMTEP set up is not really difficult—it's mostly a matter of giving proper names to the program's two parts. If you received a copy from a friend or a users' group, it's likely that the parts are already correctly named. If you downloaded them from MAUG (it is in DL8), then you need to rename them as follows: RLMTEP.302 should be changed to RLMTEP, and RLMTEP.303 must be renamed RLMTEP II. Hide RLMTEP II in a folder, and always start the program by double-clicking on RLMTEP.

Data for auto-dial, auto-log-on, and macros is entered near the beginning of the listing of RLMTEP (not RLMTEP II)—you'll see the DATA statements right after line 10. Follow the instructions from the old documentation (called RLMTEP.111 in DL8) to enter this information properly. Don't forget: If you enter only a phone number and no log-on sequence, you must include a set of empty angle brackets (<>) after the number, or the auto-dial will not work.

On its newest member disk, Club Mac includes a new stand-alone communications program called Pretty

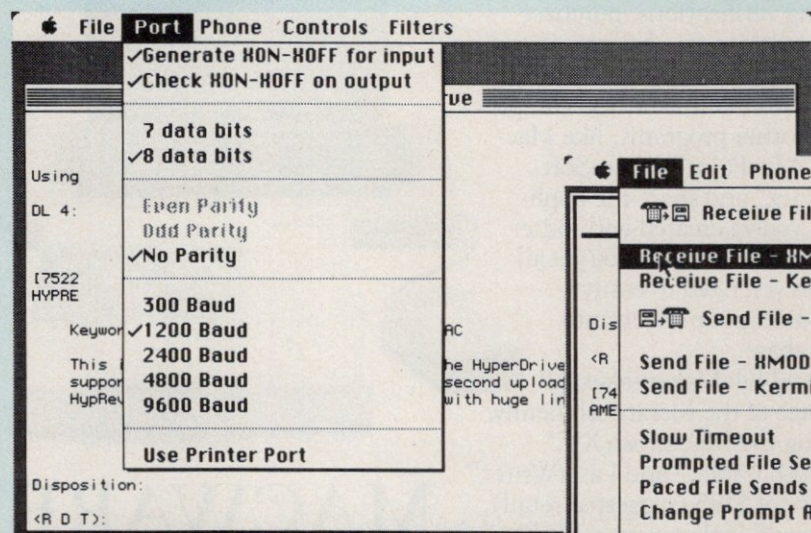
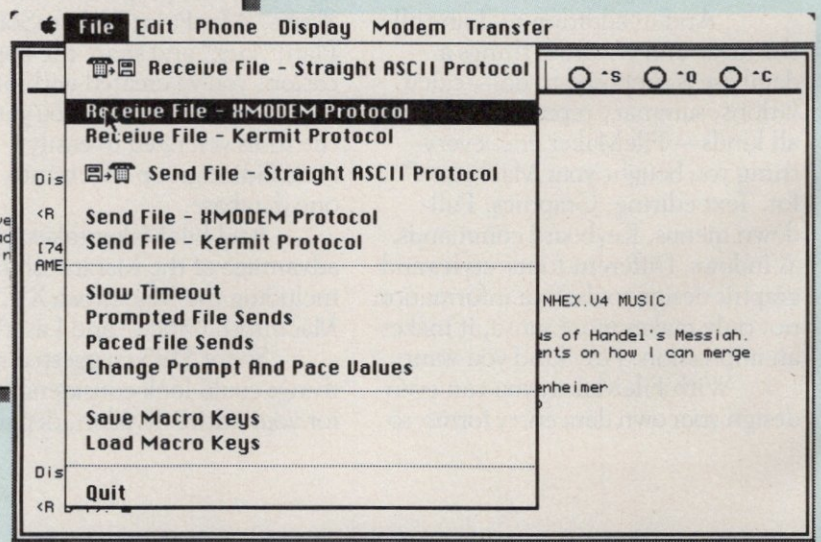
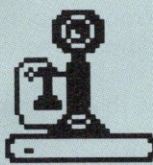

Figure 6: Pretty Good Terminal provides immediate access to the common telecommunications parameters through its Port menu.

Figure 7: With its Slow Timeout feature and the XMODEM protocol, you can use Red Ryder to download files from CompuServe without encountering time-out errors.







PGTerm

Good Terminal by Philip Zimmerman. This program has a lot of nice features, including auto-dial, XMODEM error correction for file transfers, and easy menu access to telecommunications parameters (see figure 6). All in all, this program is pretty good. It does have a significant drawback for the serious telecommunicator, however: It doesn't support automatic log-on or the creation of macros. Also, oddly enough, despite the fact that Club Mac distributes it, it does not offer VT-100 emulation and thus cannot be used to access the Club Mac bulletin board.

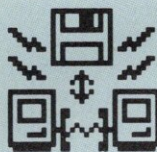

Red Ryder 4.0

Probably the most exciting public-domain telecommunications program to appear for some time is Red Ryder 4.0 by Scott Watson. This stand-alone telecommunications program fulfills just about everyone's dreams (except for that of VT-100 emulation). It has an on-screen clock and an on-screen telecommunications parameter bar that can be changed simply by clicking on it (the choices change in rotation). It supports auto-dial, auto-redial (if the number is busy), automatic log-on, and macro keys. It has a row of buttons you can click on to transmit commonly used control characters. Best of all, it has a special file-transfer choice called Slow Time-out, which, when used in conjunction with XMODEM, prevents time-out errors when you download from CompuServe—a common and exasperating problem (see figure 7).

Red Ryder is not for the faint of heart. For example, automatic log-on sequences (here called Remote Service Procedures) must first be written in a text editor and then transferred to Red Ryder. The documentation, however, as in previous versions of Red Ryder, is quite good, rather humorous, and filled with plenty of useful examples. All in all, in fact, Red Ryder 4.0 gets my vote for the best public-domain telecommunications program so far.



## The C

# for the Macintosh and Apple II

### FOR THE MACINTOSH

AZTEC C68k is the most powerful, portable, and professional C compiler and software development system for the Apple Macintosh. It is available in three configurations.

**AZTEC C68k-c (Commercial System) . . . . . \$499**

For serious Macintosh developers who want to program in C there is no parallel to AZTEC C68k-c. AZTEC C68k-c produces smaller and faster code in less time than any system benchmarked. The supporting utilities and commands of AZTEC C68k-c create a Macintosh development environment with the power and flexibility needed for producing professional results.

All C features are faithfully supported providing portability with UNIX C and AZTEC C compilers available for the APPLE II, MS DOS, PC DOS, CP/M-86, CP/M-80, TRSDOS, and C64.

Features include: C compiler, 68000 Macro Assembler, modular programming, overlay linker, debuggers, mouse based editor, Z(Vi) editor, SHELL development environment (UNIX was developed to support software development - this environment incorporates the best of UNIX), comprehensive support of the Macintosh including the toolbox to provide straight forward development of Macintosh programs and desk accessories, make, diff, grep, terminal emulator (source), grow (source), desk accessory (source), ramdisk (source), UNIX I/O, MATH, UTILITY, and MACINTOSH run time libraries (source), full support for 512k Mac and Lisa Macworks, 600+ page manual, resource maker, calling C routines from PASCAL, PASCAL from C, and assembler subroutines, no-royalty license.

Manx support includes one year of computer tracked updates and technical telephone support.

**AZTEC C68k-d (Developer's System) . . . . . \$299**

AZTEC C68k-d provides a less expensive development system for programmers on limited budgets. AZTEC C68k-d includes C compiler, 68000 Macro Assembler, Linker, debuggers, editor, toolbox support, run time libraries (object), sample programs (source), and a 600 page manual.

**AZTEC C68k-p (Personal System) . . . . . \$199**

For students and professionals doing serious non-commercial work. Includes C compiler, Linker, run time libraries, sample programs (source), debugger, and editor. Restricted license.

**C-TREE Database (Aztec object format) . . . . . \$149**

**C-TREE Database (Object + Source) . . . . . \$390**

### FOR THE APPLE II

**AZTEC C65/DEV (Developer's System) . . . . . \$299**

This C compiler and software development system comes with C compiler, 6502 assembler, SHELL, overlay linker, UNIX I/O, Screen, and Graphics libraries, editor, utilities, and support for ProDos.

**AZTEC C65 . . . . . \$199**

C compiler, 6502 assembler, Linker, libraries, Apple DOS 3.3 support.

**AZTEC C65 Personal . . . . . \$ 99**

C compiler and development system. Restricted license.

# MANX

TO ORDER OR FOR INFORMATION  
CALL OR WRITE:

MANX SOFTWARE SYSTEMS  
Box 55 • Shrewsbury, NJ 07701  
TX 4995812



**CALL:  
800-221-0440  
201-530-7997 (NJ)**

**TECH SUPPORT - 201-530-6557**

CP/M-80 and CP/M-86 are trademarks of DRI Macintosh and PRO DOS are trademarks of Apple  
TRS DOS is a trademark of Tandy UNIX is a trademark of ATT

CIRCLE 189 ON READER SERVICE CARD

**YOUR  
SOURCE**  
For

**Macintosh™  
SOFTWARE AND  
ACCESSORIES**

**BRAND NAME  
MAC products at  
DISCOUNTED  
PRICES.**

**SOFTWARE  
HARD DRIVES  
MODEMS  
DISKETTES  
DISKETTE CASES  
PRINTERS  
CARRYING BAGS  
...AND MORE!**

**New products are being added to  
our inventory weekly. Call today  
for our latest list and prices.**

**(404) 446-2295**

or

**MAIL THE COUPON BELOW**

Please send me your latest list of products for the "MAC", along with your discounted prices.

NAME \_\_\_\_\_  
STREET \_\_\_\_\_  
CITY \_\_\_\_\_  
STATE \_\_\_\_\_ ZIP \_\_\_\_\_  
PHONE \_\_\_\_\_

**DESKTOP**  
  
**software center**

DESKTOP SOFTWARE CENTER  
4115 FRANK NEELY RD., NW  
NORCROSS, GA. 30071

Macintosh is a trademark of Apple Computer, Inc.

# FINDING MAC SOFTWARE ON COMPUERVE

CompuServe's Micronet Apple User's Group (MAUG), which covers both 8-bit and 32-bit Apple computers, has sections for bulletins, on-line conferences, public-domain-software exchange, and member-to-member. To get to MAUG from anywhere in the Consumer Information Service (CIS) part of CompuServe, type GO PCS-51 at any prompt (!). If you have never entered MAUG before, you will be asked to join simply by giving your name. Your membership should be processed within 24 hours (without charge).

Once you have entered MAUG, you are greeted by the Function menu. Select number 4 (Data Library) at the prompt; a new menu appears, listing the nine different data libraries in MAUG, and you are asked to choose one of them.

The important choices for Mac owners are the following: DL3 (for Data Library, subtopic 3) is primarily for programmers, although it is worth scanning from time to time by the rest of us; DL5 is for developers—most of the programs here are pretty hair-raising and largely unfathomable; DL8 is dedicated to communications programs and is definitely worthy of your attention, especially if you are using public-domain communications software; DL4 is the section of greatest interest, however, and is

without doubt the single most important source of public-domain software for the Macintosh.

Since its creation more than a year ago, DL4 has grown to such a size that it is now almost impossible for a newcomer to survey its contents completely without ringing up a small fortune in on-line charges. If you are new to MAUG, the most sensible thing for you to do (until you are a little more familiar with DL4) is to first browse through 10 or 20 of the latest additions. To do this, simply type BRO at the DL4 prompt, and the library will give you brief descriptions of the software it contains—one at a time, starting with the most recent addition.

When you've seen enough, return to the top menu (by typing T) and try browsing according to a topic that interests you, by using the Key option. Type BRO/KEY: at the DL4 prompt, and follow the colon with a single word, such as GAME, that reflects an interest of yours. This procedure doesn't always work very well and sometimes yields unexpected results, since many of the people who contribute software to MAUG are not very careful about the keywords they choose. But unless you know the exact name of a program, this is probably the best way to start your search for interesting software.

## FURTHER INFORMATION

Microsoft Corp. (Microsoft BASIC)  
10700 Northup Way  
Bellevue, WA 98009  
(206) 828-8080

CIRCLE 389 ON READER SERVICE CARD

CompuServe  
5000 Arlington Centre Blvd.  
P.O. Box 20212  
Columbus, OH 43220  
(800) 848-8990 (contiguous U.S.)  
(614) 457-8650 (Ohio)

CIRCLE 393 ON READER SERVICE CARD

Club Mac  
735 Walnut  
Boulder, CO 80302  
(303) 449-5533  
Annual Membership: \$35

CIRCLE 391 ON READER SERVICE CARD

Apple Computer, Inc. (MacTerminal)  
20525 Mariani Avenue  
Cupertino, CA 95014  
(408) 966-1010

CIRCLE 392 ON READER SERVICE CARD

New York MacUser's Group  
P.O. Box 6686  
Yorkville Station  
New York, NY 10128  
Annual Membership: \$32

CIRCLE 390 ON READER SERVICE CARD

Berkeley Macintosh Users' Group  
1442A Walnut Street  
Suite 153  
Berkeley, CA 94709  
(415) 849-9114  
Semester Membership: \$15

CIRCLE 394 ON READER SERVICE CARD

(continued from page 106)

though, unlike with File, text does not reformat automatically to fit a resized window). Although Edit is not likely to replace MacWrite or Microsoft Word as anyone's basic writing tool, it is now my only choice when it comes to large-scale searches and formatting.

Because good commercial communications programs were a long time coming for the Mac (some say they still are), communications software has been, from the beginning, a fertile field in the public domain. For newcomers to telecommunications, some of the simpler public-domain programs are a logical place to start, because they offer few of the many options likely to confuse beginners. (See "Public-Domain Communications Programs" on page 110 for descriptions of some of these programs.)

If you've been using a Mac for any length of time, you have probably thought about ways you'd like to tailor its operation to fit your own style and special needs. So far, very little commercial software allows you to tinker with the way the computer works. The public domain, however, is full of little gems, called utilities,

that let you customize the way your Mac works and accomplish a lot of other things as well.

One of the most useful utilities for customizing your Mac is Menu Editor 1.0 by Andy Herzfeld. If you've ever lamented that an often-used menu item does not have a keyboard equivalent, this program is for you. Say, for

example, you frequently toggle the grid on and off when using MacPaint, but the lack of a ⌘-key equivalent forces you to pull down the Goodies menu every time you want to switch it on or off. With Menu Editor, you can add a Grid keyboard command (see figure 4).

Menu Editor is not totally bug-

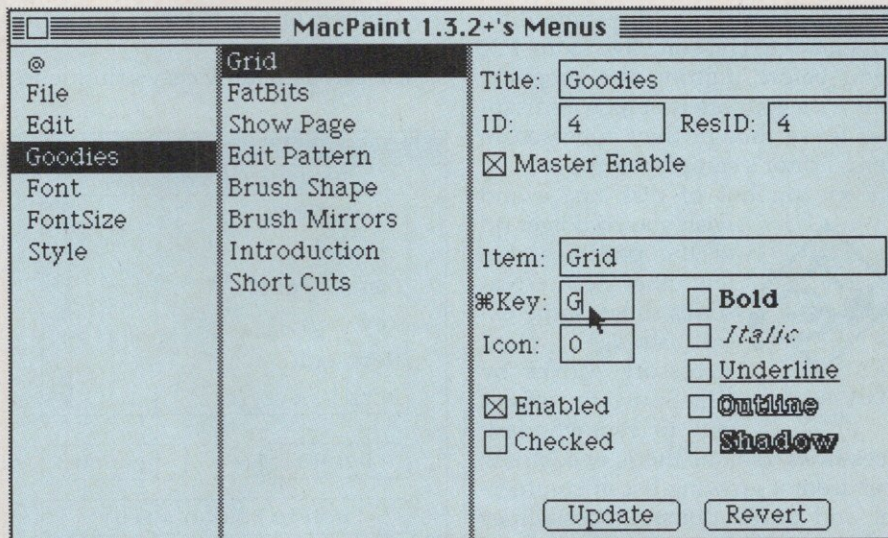
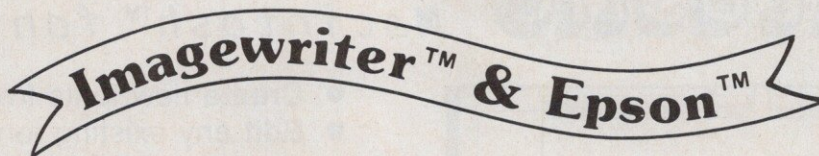

Figure 4: Menu Editor allows you to add a ⌘-key equivalent for a menu item that doesn't have one, or change one that does. Here Grid in the Goodies menu is being assigned ⌘-G in the small box, middle right. Note that the menu being worked on appears in the menu bar, so you can open it and confirm what you have done before quitting the program.

# Ribbon Land



Color Ribbons • Black Ribbons • Heat Transfer Ribbons

Plus

4 New Color Print® Software Packages For the Mac & Imagewriter

- Color Ribbons (Red, Blue, Green, Brown, Yellow & Purple) ..... Each \$ 6.00
- Black Ribbons ..... Each \$4.50 Box of 6 - \$24.00
- Heat Transfer Ribbons (Black, Red, Blue & Yellow) ..... Each \$9.00 Box of 4 - \$32.00
- T-Shirt Factory™ (Includes 1 Each Color Heat Transfer Ribbon & Instructions) ..... \$32.00
- Color 6 Pack (Includes 1 Each Color Ribbon & Instructions) ..... \$32.00
- Color Print® 3 (Includes Color Print Software, Manual, & 1 Each Red, Blue & Yellow Ribbon) ..... \$55.00
- Color Print® 6 (Includes Color Print Software, Manual, & 1 Each Color Ribbon) ..... \$69.00
- Color Print® Transfer (Includes Color Print Software, Manual, & 1 Each Color Heat Transfer) ..... \$69.00
- Color Print® System (Includes Color Print Software, Manual, & 1 Each Color Ribbon & Heat Transfer) \$99.00

\*Guaranteed - Lowest Prices, First Quality, and Customer Satisfaction!!!

\*Imagewriter is a trademark of Apple Computer, Inc.

\*T-Shirt Factory is a trademark of I/O Design, Inc.

\*Color Print is a registered trademark of Esoft Enterprises, Inc.

\*Add \$3.00 Shipping and Handling for orders under \$100.

\*MC, Visa, Check and C.O.D. Orders Accepted.

**Ribbon Land • P.O. Box 8634 • Red Bank • NJ • 07701 • 201-842-1437**

CIRCLE 162 ON READER SERVICE CARD

free, so a little care is in order when you use it. (This caution applies to many public-domain programs, actually.) In particular, make sure that the command you are adding is not already provided by another menu item. Also, even though a selection box allows you to choose programs from any disk drive, it is best to place both Menu Editor and the program you wish to alter on the same disk. Remember to click on Save in the File menu before quitting the program; otherwise your alterations will disappear (even though they appeared in Menu Editor's sample menu).



Desk Accessory Mover

Ever run out of disk space and wish you could get rid of the puzzle and a few other desk accessories to get some extra storage? Desk Accessory Mover by CE Software allows you to remove desk accessories, rename them, or add new ones from a growing list of commercial and public-domain possibilities (see figure 5). It is easy to use and comes with a short but clear documentation file, as well as several amusing (but not very useful) desk

accessories for experimentation.

The only drawback to the Desk Accessory Mover is its incredible slowness. The first time I used it, I was convinced that the program had crashed and my disk drive had gone berserk. I was wrong. It is just unbelievably slow. Sad to say, because the program permits you to install or delete only one desk accessory at a time, the problem of sluggishness is magnified even further.

You can try a fairly easy solution to

the Desk Accessory Mover's slowness, however, if you have a 512K Mac. If you copy the System file and the Desk Accessory Mover to a RAM-disk and make the RAMdisk the start-up disk, the program will operate at a much more acceptable speed. A RAMdisk is a section of the computer's random-access memory that looks to you and acts to the computer just like a floppy-disk drive. Because it is actually a segment of RAM, however, it runs at electrical, rather than

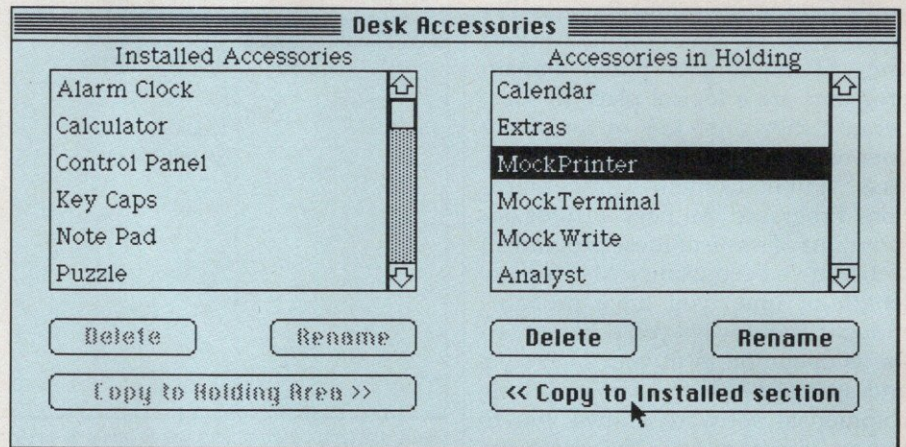
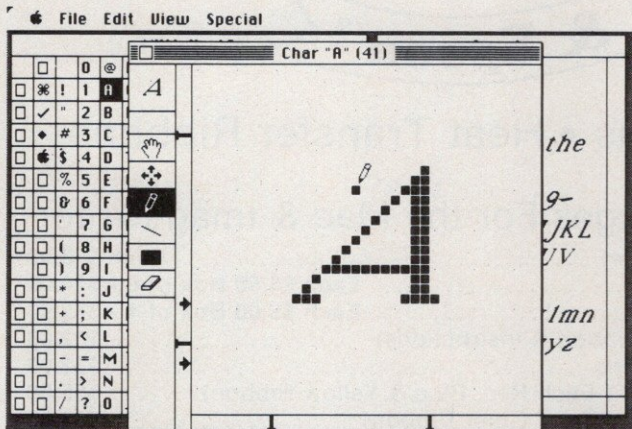

Figure 5: You can use the Desk Accessory Mover to add new accessories, to delete (or put in special storage files) the ones you no longer need, or to rename them. In this illustration, MockPrinter is about to be installed in the System.

# Fontastic™

Macintosh™ font editor



**Altsys**  
corp.

P.O. Box 865410  
Plano, TX 75086  
(214) 596-4970

Now shipping  
version 2.0  
with bit-level  
cut & paste

- Create new fonts from scratch
- Edit any existing fonts
- Style characters automatically  
Bold, italic, underline, shadow, invert
- Scale fonts automatically
- Cut and paste characters
- Full undo and revert capabilities
- Define large fonts up to 120 points
- Use labor-saving editing tools  
Line, box, pencil, eraser, scrolling hand
- Move fonts with built-in mover

**\$49.95—includes shipping**

MasterCard, Visa, or personal checks accepted—  
Texas residents add sales tax

CIRCLE 235 ON READER SERVICE CARD

mechanical, speed. For the same reason, if you turn off the computer without saving the RAMdisk's contents to a real floppy, you will lose all the files on the RAMdisk.

If the idea of using a RAMdisk with the Desk Accessory Mover (or any other copyable program) appeals to you, then you should try a simple program called Ramdisk. It creates a

## PUBLIC-DOMAIN SOFTWARE A SELECTED LIST

### Screen Maker

- MAUG's DL5 (SCRMAK.HEX)
- Club Mac BBS (SCRNMK.APL)

### BinHex 4.0

- MAUG's DL4 (BNHX4.HCX)
- Berkeley MUG (Disk #10)
- Club Mac BBS (BHEXV4.APL)

### Banner

- MAUG's DL4 (BANNER.HEX)
- Berkeley MUG (Disk #3)
- Club Mac BBS (BANNER.APL)

### Rolodex

- Berkeley MUG (Disk #1)
- NYMUG (Disk #3)
- Club Mac BBS (ROLODX.APL)

### File 1.0

- Friends

### File 1.UTAH

- MAUG's DL4 (UTAHF1.HEX)
- NYMUG (Disk #7)
- Club Mac BBS (UTAH.APL)

### Edit

- MAUG's DL5 (EDITOR.HCX)
- Berkeley MUG (Disk #10: MDS Edit)
- Club Mac BBS (NEWEDT.APL)

### MacTEP 1.81m

- Friends

### AutoTEP.vs2

- MAUG's DL8 (MAUGTE, MAUGTE.NOT)

### Auto MacTEP Mouse 1.87

- MAUG's DL8 (AUTOTE.187)

### TEP Plus

- MAUG's DL8 (TEP, TEPFIX.TXT, TEPHLP.BAS)

### RLMTEP 3.0

- MAUG's DL8 (RLMTEP.302, RLMTEP.303, RLMTEP.111)

### Pretty Good Terminal

- Club Mac Member Disk
- Club Mac BBS (PGTERM.APL and PGTERM.DOC)

### Red Ryder 4.0

- MAUG's DL8 (RYDER.HQX, RRDOC1.HQX, RR1DOC.HQX, RR2DOC.HQX, RR3DOC.HQX)

### Menu Editor

- MAUG's DL5 (MENUED.HCX)
- Berkeley MUG (Disk #10)

### Font Editor

- MAUG's DL5 (FONTEH.HEX)
- Berkeley MUG (Disk #6)
- NYMUG (Disk #5)

### SetFile

- Berkeley MUG (Disk #6)

### RMover

- MAUG's DL5 (RMOVER.HEX)
- Berkeley MUG (Disk #6)

### Resource Editor

- MAUG's DL5 (REDIT.HCX)
- Berkeley MUG (Disk #10)
- Club Mac BBS (name not assigned at press time)

### Desk Accessory Mover

Send a disk and a self-addressed mailer to:

C.E. Software  
801 73rd Street  
Des Moines, IA 50312  
(515) 224-1995; or:

- MAUG's DL4 (DAM.V14)
- Berkeley MUG (Disk #10)
- NYMUG (Disk #6)
- Club Mac BBS (DAMV14.UTL)

### Ramdisk

- MAUG's DL4 (RAMDISK.HCX and RAMDIS.DOC)
- Berkeley MUG (Disk #3)

*Note: The sources mentioned are provided to help you locate the software—they are not by any means the only places you can find these programs.*

# HIPPO-C™

## The C compilers for the Macintosh™

### LEVEL 1

**Powerful, expandable, yet affordable:**

- A friendly, integrated environment complete with a screen editor, full K&R C compiler, linker, source-level debugger, tutorial, standard C library, and structure definition files.
- Access to over 400 Toolbox routines.
- Convenient access to serial ports and sound channels.
- Over 200 pages of documentation and many sample programs.
- Upgradable to Hippo-C Level 2 for \$250.00.
- New version 1.2.
- **\$149.95**

### LEVEL 2

**Professional C development system:**

- Allows for the creation of large, stand-alone commercial applications.
- Comes with a screen editor, optimizing K&R C compiler, 68000 assembler, linker, C library, stdio package, full floating-point support (including math and trig functions), and structure definition files.
- "Glue" routines which allow easy access to Macintosh features.
- UNIX™-like shell which includes many powerful commands and utilities.
- Convenient access to over 500 Toolbox routines.
- Documentation, many sample programs, and sources.
- No royalties or license fees.
- You may obtain a non-copy protected disk by signing and returning a form along with \$25.00 to Hippopotamus.
- **\$399.95**

# HIPPO-LOCK™

## The Hippo Business Data Security System

- Encrypts all of your important Macintosh files to protect them from curious eyes. Encrypts Mac-Write documents, MacPaint pictures, data bases, spreadsheets, data files, application programs, etc.
- Useful for protecting confidential information such as business plans, payroll information, sales projections, employee reviews, management proposals, grades, etc....
- Choose between three levels of security.
- Uses the NBS DES Data Encryption Standard, used widely by major corporations and the U.S. Government.
- **\$119.95**

# HIPPOTAMUS™

SOFTWARE, INC.

985 University Avenue Suite 12 Los Gatos, CA 95030

408 395-3190

Dealer inquiries welcome. We accept credit cards, checks, and money orders. California residents add local sales tax. Please include \$10 for shipping and handling. Export of Hippo-Lock may be limited by law and subject to license. Macintosh is a trademark of Apple Computer, Inc. UNIX is a trademark of AT&T Bell Labs. Hippo-C and Hippo-Lock are trademarks of Hippopotamus Software, Inc. Please allow 1-2 weeks for delivery. Price, availability, and specifications subject to change without notice.

CIRCLE 197 ON READER SERVICE CARD

# GATO™



## WW II GATO-Class Submarine Simulation 3-D Graphics with Sound

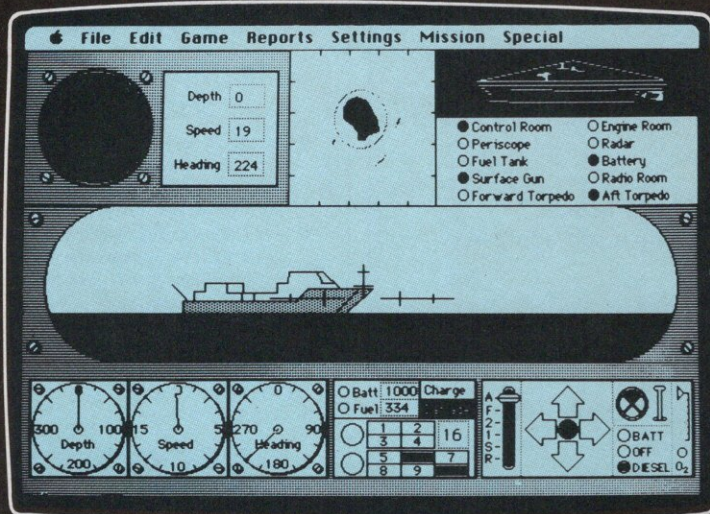

**Macintosh Version**  
**Also Available for Apple® IIe/c or**  
**IBM® PC Series (includes PCjr.)**  
**Minimum 128K**

SPECTRUM HOLOBYTE, INC., 1050 Walnut, Suite 325, Boulder, CO 80302 (303) 443-0191. Check your local computer store or wherever software products are sold. Dealer Inquiries call: (800) 621-8385 x 262. Written by Paul Arlton and Ed Dawson. IBM and Apple are registered trademarks of International Business Machines Corp. and Apple Computer, Inc. respectively.

RAMdisk of only one size (320K), and you must alter your System file with RMOVER (or the new Resource Editor) in order to run it, so it is considerably less versatile than Mac Memory Disk from Assimilation Process, which is a well-designed commercial RAMdisk program.

If you are unsure about whether or not RAMdisks are for you, though, experimenting with Ramdisk for a while may resolve your uncertainty—at which point you can go out and buy Mac Memory Disk. (For more information about Mac Memory Disk see “Mac Memory Disk Makes a Fat Mac Fast” in the March 1985 issue of *A+*, pages 86–91.)

Desk accessories you can install with Desk Accessory Mover, fonts, games, graphics for use with MacPaint, files for commercial programs such as Multiplan and Filevision, public-domain versions of Forth and Lisp, and more are in store for you in the second part of this article. +

*Robert Eckhardt recently resigned as Vice President of Simon & Schuster's Electronic Publishing Group to devote more time to reading, writing, and being outdoors.*

## Macintosh Aficionados

*A+ would appreciate receiving any tips, hints, shortcuts, or suggestions that you have for using the Macintosh computer. We would like to publish these pearls in our MacTips feature in our Macintosh section.*

*You'll receive credit in the magazine, and we'll pay \$50 for each MacTip that we use.*

*Send your tips to:*

MacTips  
 A+ Magazine  
 ATTN: Fred Davis  
 11 Davis Drive  
 Belmont, CA 94002

# The most BASIC.

Microsoft® BASIC is the language spoken by nine out of ten microcomputers worldwide. It's the language with the most programs written for it.

So if you want to access the power of your Macintosh™, only one language makes the most sense. Mac's first language, Microsoft BASIC.

Not only is it the industry standard, it's the most advanced BASIC for Macintosh. It lets you add mouse commands. Graphics. Windows. Change type fonts and styles. Customize menus. Incorporate music and sound effects. Write your own dialog boxes. Basically, it lets you take advantage of everything that makes Mac 'Mac'.

It makes editing programs as easy as cutting and pasting and pointing and clicking. Debugging is easier

than ever with the advanced trace command.

It's no wonder Microsoft is the most logical choice for the Macintosh.

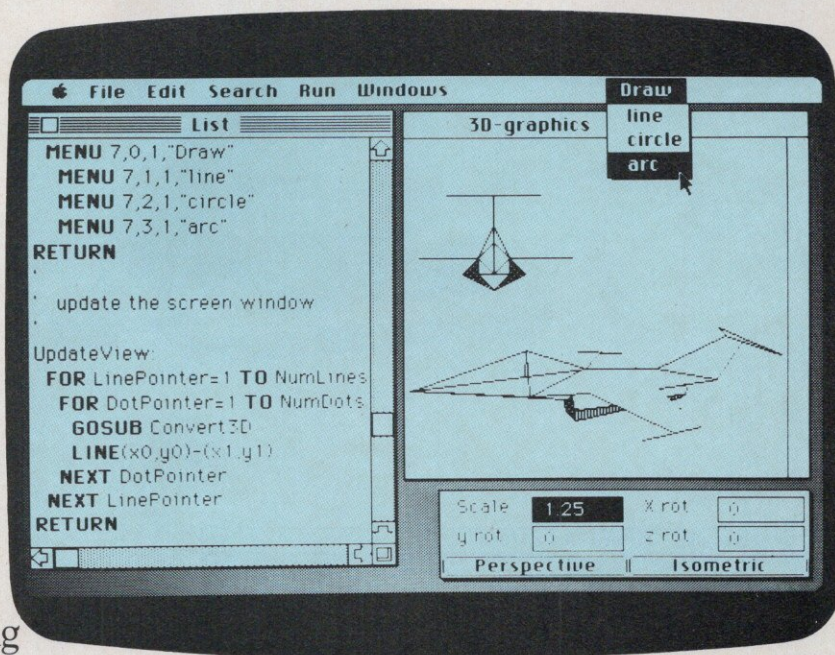

**MICRO  
SOFT**

**MICROSOFT**® We've  
The High Performance Software written more  
Macintosh programs than any other  
software company. Including Mac's  
spreadsheet, Multiplan.®

So if you want to get the most out of your Macintosh, call (800) 426-9400 for the name of your nearest Microsoft dealer. In Washington State, Alaska, Hawaii and Canada, call (206) 828-8088.

Microsoft and Multiplan are registered trademarks of Microsoft Corporation.  
Macintosh is a trademark licensed to Apple Computer, Inc.  
CIRCLE 175 ON READER SERVICE CARD

# Mail Center™ Delivers!

## Electronic Mail for the Macintosh™ Office.

Need to send a memo to everyone in your department? **Mail Center** will deliver. Even if they are working furiously with other programs on their computer. Designed to be used with the AppleTalk Personal Network™, **Mail Center** offers every office an easy and efficient means of improving communications. Meeting notices, reports, memos, letters, spreadsheets, charts and graphics can all be sent quickly and easily to everyone who needs to know. In fact, practically any Macintosh document can be sent from one Macintosh to another in record time. **Mail Center** software for Macintosh. No wait delivery for the Macintosh office.

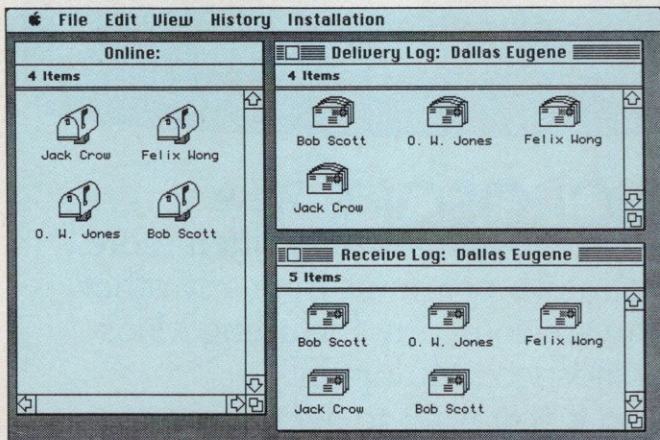
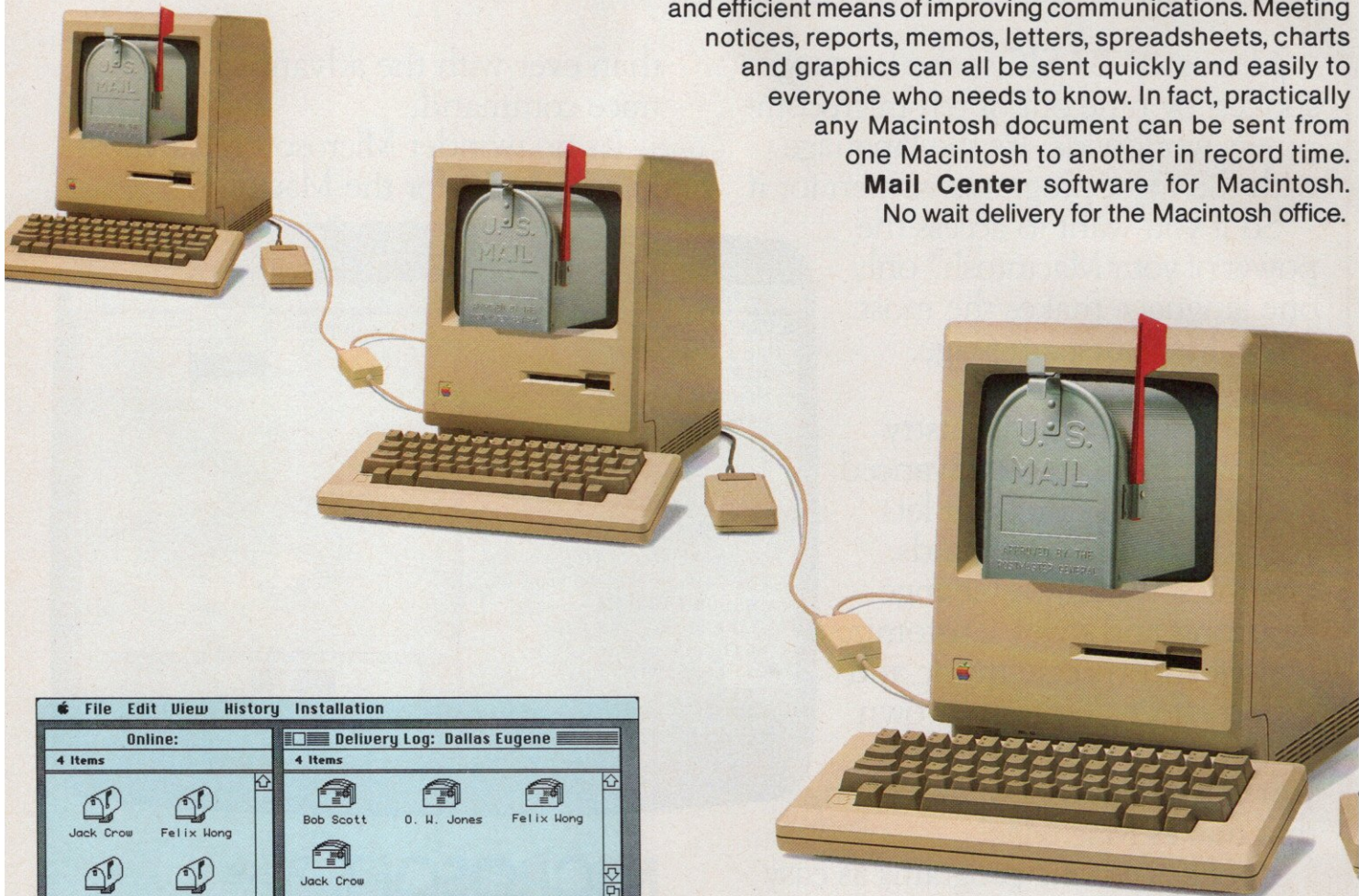

**Suggested Retail Prices**  
**Twin Pack \$299**  
**Six Pack \$499**

SEE US AT BOOTH #4171 AT  NCC '85



Mail Center is a trademark of Videx, Inc. AppleTalk Personal Network is a trademark of Apple Computer, Inc. Macintosh is a trademark licensed to Apple Computer, Inc.

CIRCLE 146 ON READER SERVICE CARD

1105 N.E. CIRCLE BLVD., CORVALLIS, OR 97330  
503-758-0521



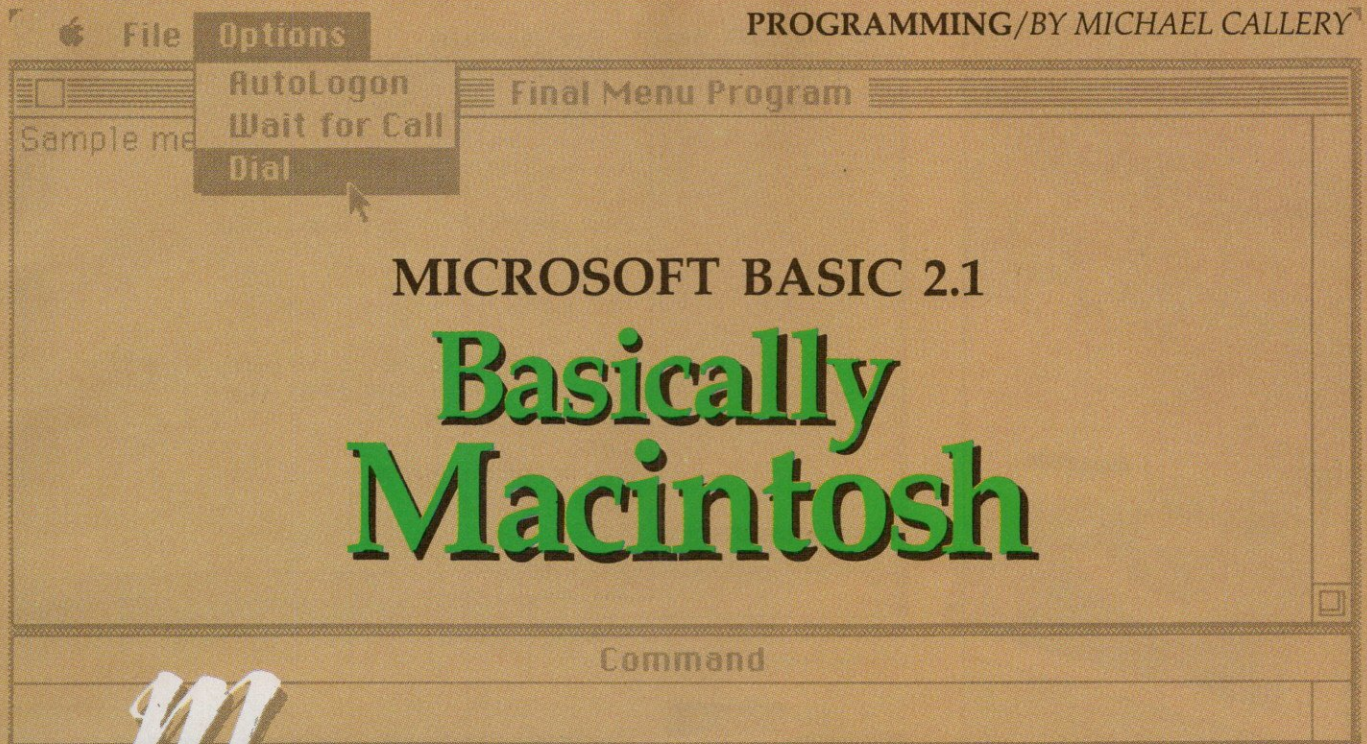

## MICROSOFT BASIC 2.1

# Basically Macintosh

**M**any people used to believe that if you owned a personal computer, you had to know how to program it, but that belief is no longer valid. The multitude of off-the-shelf software allows you to use computers without having knowledge of programming languages.

The Apple II, the IBM Personal Computer, and most other popular microcomputers have a version of the BASIC programming language built into the computer's permanent memory. Thus, industry observers were surprised when Apple released the Mac without a built-in language. Apple had designed the Mac for non-technical users.

So why would anyone want to program "the computer for the rest of us"? For one, programming is an unparalleled intellectual pursuit. The process of writing a program is a good, solid problem-solving exercise. When the bugs have been squashed and the program runs, the sense of achievement is real. Your program may also help you solve a problem or increase your productivity. Whether you program for intellectual stimulation or to create useful tools, you'll also learn a lot about the Mac.

Microsoft BASIC 2.1 for the Macintosh (MS-BASIC), which is an identical but speedier version of MS-BASIC 2.0, does allow you to use programs created with the more-primitive version 1.0. It includes a rich set of instructions to let you tap

*Programming is an unparalleled intellectual pursuit. When the bugs have been squashed and the program runs, the sense of achievement is real.*

the power of Apple's custom software contained in the Macintosh ROM toolbox. It enables you to produce BASIC programs that take advantage of menu bars, alert boxes, edit boxes, and so on—all from your programs, all in BASIC. MS-BASIC 1.0 or 2.0 owners who want to upgrade to version 2.1 can do so for \$50.

The Macintosh screen in Microsoft BASIC is divided into several windows, each with a different function. You write and view programs in the List window, look at output in the Output window or windows, and enter commands or individual program lines in the Command window. You can size, move, and close the windows with the mouse. (Figure 1 shows a typical screen during programming.)

You enter program lines in the List window. Unlike Microsoft BASIC on

other computers, Mac MS-BASIC 2.1 allows, but does not require, line numbers. It executes program lines in order of their occurrence in the List window. To move a line to another location, you can use the Mac's Cut and Paste functions. The clipboard is fully functional and allows you to move blocks of code from one program to another or to move pictures into MS-BASIC.

MS-BASIC creates a primary Output window for text and graphics. The window bears the title of the program or is labeled "Untitled" if you haven't saved the program yet. Output is displayed only temporarily within the window. That is, if you open the List window and then close it, the text or graphics beneath the List window will be erased. You can open up to four output windows, but only one can be active at a time.

**T**he primary use of the Command window is as a place to type a quick TRON (TRace ON) or to print the value of a variable. You can issue most commands—Save, Load, List, Find, Stop, Run, and so on—most efficiently by using a ⌘-key sequence or the menu bar. The MS-BASIC 2.1 menu bar also includes options that display the Command, List, or Output window.

**SEE  
what you're  
printing!**

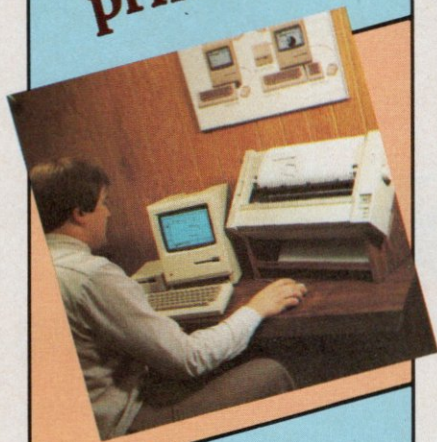

The Printer Stand lets you see the paper as it's being printed

- Tilts Your Printer to a 45° Angle
- Space-Saving Convenience - paper feeds from underneath - fanfolds in front or behind.
- Solid Wood Construction
- Naturally hand-finished solid oak or walnut hardwoods
- Non-slip padded grips insure a solid foundation and protection for the printer
- The Printer Stand 80 fits 80 column printers **Only \$49.95**
- The Printer Stand 132 fits 132 column printers **Only \$59.95**

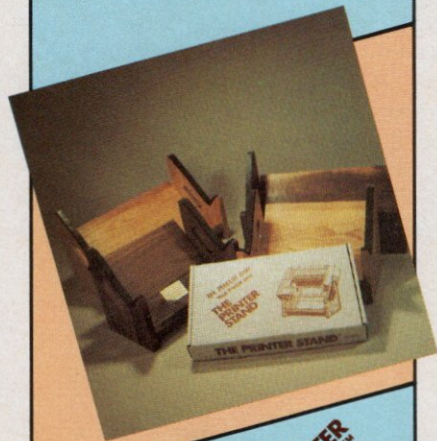

**THE  
PRINTER  
STAND™**

For more information, see your local computer dealer or call collect.

Synergy Products  
809 E. Chestnut St.  
Boonville, IN 47601  
(812) 897-5351

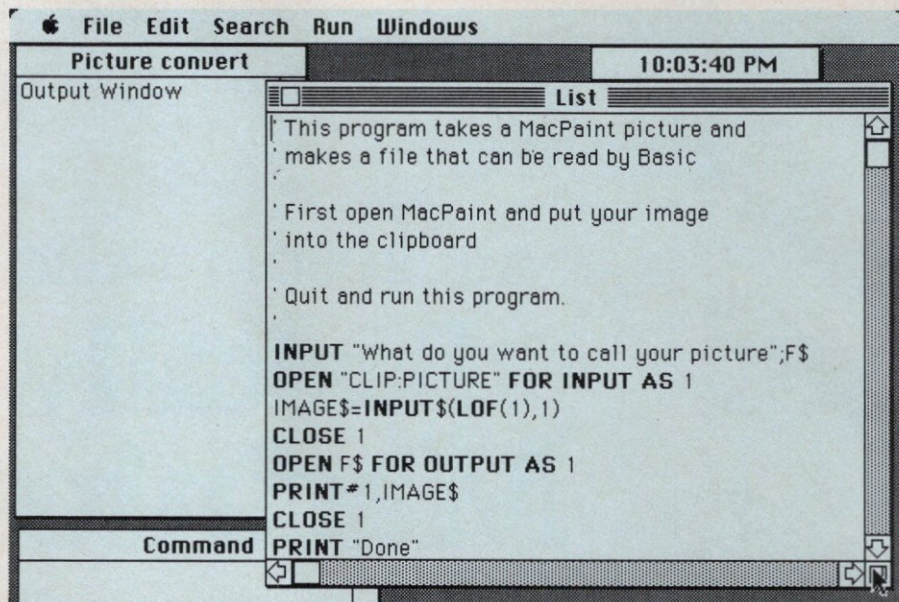

Figure 1: The MS-BASIC 2.1 programming screen. The List window is currently active, and the clock is the usual desktop accessory.

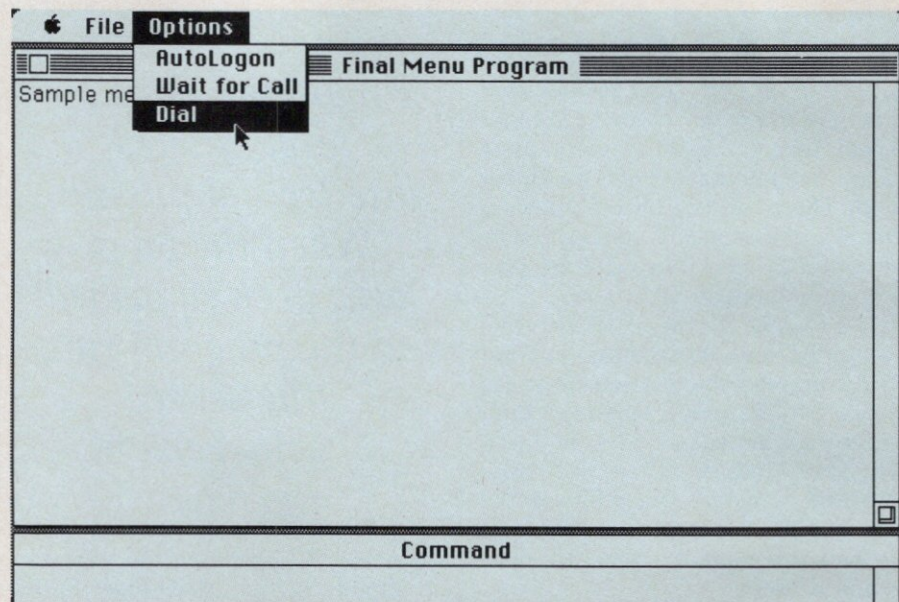

Figure 2: The output of the menu program with the Options menu pulled down. A dialing function has not been provided in the program.

MS-BASIC is a much-evolved version of the original Microsoft BASIC, distantly related to Applesoft BASIC. MS-BASIC for the Mac has improved control structures with IF/THEN/ELSE and WHILE/WEND, input with LINE INPUT, and output with PRINT USING. I/O is "device-independent," which simplifies programming for devices other than the screen or disk drive. PSET, PRESET, LINE, CIRCLE, PUT, and GET instructions all support graphics.

If you have never programmed or if the preceding language features are only so much jargon, suffice it to say that these features make MS-BASIC for the Mac simpler than Applesoft to

learn. The most exciting part of this MS-BASIC, however, is the wide selection of instructions that enable you to tap into the Macintosh-toolbox software resources such as menus, dialog boxes, mouse functions, and QuickDraw graphics routines.

The following sample programs might be useful as subroutines in a simple terminal program, but they would need revision if you were to incorporate them into an actual terminal program. The first example shows you how to create a custom menu bar.

#### Making Menus

Most Macintosh applications should use a menu bar for the primary program commands. You pull

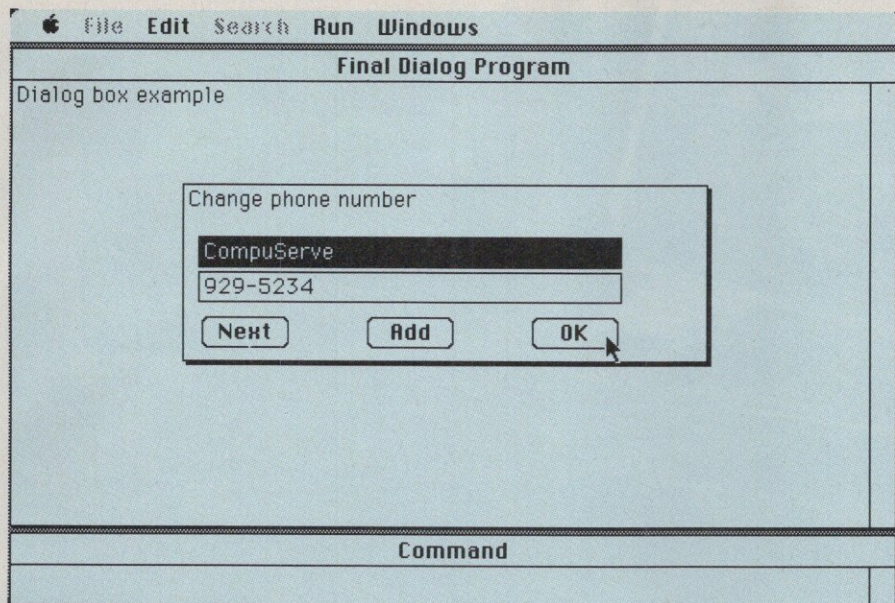

Figure 3: The output of the button program. The edit boxes with the information-service name and number can be edited in the normal Mac manner.

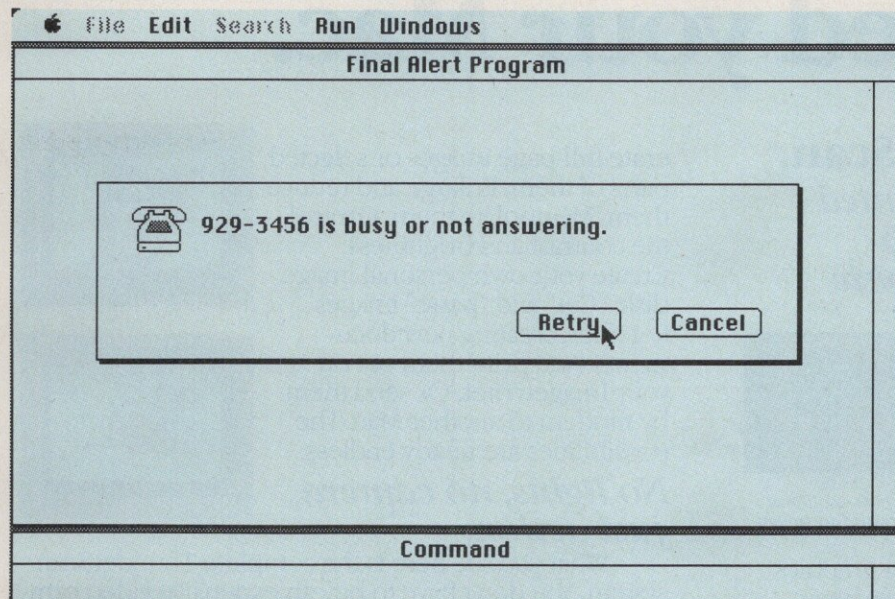

Figure 4: The output of the alert-box program. Note the phone icon. An alert box in a terminal program will tell you if the number you just called is not answering or is busy.

down the menu and select the command.

In MS-BASIC 2.1, you can create custom menu bars with the MENU statement, and you use the MENU function to specify items to be listed in each menu bar.

Here's a program that puts a sample menu on the screen for an imaginary terminal program (see figure 2 for output).

Program 1

```
' menu example
CLS
PRINT "Sample menu"
' erase normal menu
```

```
FOR i = 3 TO 5: MENU i,0,0,"": NEXT i
' put up new menus
' in locations 1 and 2 on menu bar
MENU 1,0,1,"File"
MENU 1,1,1,"Send"
MENU 1,2,1,"Save"
MENU 1,3,1,"Quit"
MENU 2,0,1,"Options"
MENU 2,1,1,"AutoLogon"
MENU 2,2,1,"Wait for Call"
MENU 2,3,1,"Dial"
```

```
' setup event queue notification
ON MENU GOSUB Menucheck:MENU ON
' do nothing until menu is selected
idle: GOTO idle
```

## The MacSOURCE<sup>©</sup>

Infotek, Inc. (516) 289-9682

56 Camille Ln. E. Patchogue, NY 11772

512K Macintosh w/10 MB internal

harddisk, special software.....\$3999.

Internal 10 MByte harddisk.....\$2100.

Piggyback 10 MB 5.25" harddisk.\$1695.

512K Ram Upgrade: board swap ...\$399.

MacMegRam: Add 1MB RAM .....\$1195.

MacNetwork File Server+hd.....\$1800 up

PortableMac: Runs w/o AC power

..Add-on kit:\$299; complete:\$2295.

MacUPS+AC despike-runs your Mac for

30 min. w/o AC power.....\$199.

Public Domain Software (over 60 vols in

library) .....\$8.50/disk.

MacHardware- for removing the Mac's

cover.....casual:\$19.95; prof.:\$40.

MacTest-be sure your Mac works...\$39.

Imagewriter ribbons: bl \$5.50,col.\$7.50

Diskette, 3.5" SSDD micro.....\$2.99 up

MacSpeaker: 3 Watts, in cabinet.....\$20.

Composite Video Adapter.....\$189.

MacFan-Kit to keep your Mac cool..\$49.

CAD, CAM, CIM software.....CALL

Image Digitizing systems.....CALL

DBMS: Mainframe class application gener-

ator,post-relational database\$349

Mac Plotters(Apple,HI,HP).....\$600 up

Plotter driver software.....\$190 up

Plotter interface cables.....\$30.

Laser Printer-300 Pixels / inch, stand-

alone:\$3300.; networked:\$6800.....

Complete MultiUser System: Network up

to 4000 Macs to a UNIX Micro Main-

frame "host". This host becomes an

information & communication server;

supports printer spooling; allows Mac

applications to be loaded from host;

allows Macs to become terminals to

host UNIX applications such as Unify,

Informix, RealWorld. Mac's friendly

user interface is retained.....CALL

Surge protected multiple outlet box.\$49.

Desktop Work Station stand.....\$49.

MacEnhancer: Adds 4 more ports..\$194.

MacReinker: reinks printer ribbons.\$30.

AppleTalk Network box & 30' cable \$39.

Electronic Office publishing & composing

system (HW+SW+laser printer)\$6495

## The Apple// SOURCE<sup>©</sup>

Apple//c,IIe compatible system. RGB or

composite video, 80 col screen, RS-

232 and Parallel ports, disk inter-

face, software (spreadsheet, word

processor, file manager).....\$479.

Apple//c,IIe compatible disk drive\$179.

## The LisaSOURCE<sup>©</sup>

XL Serve-software that turns a MacXL

into a networked file server ....\$189.

We still support the MacXL/Lisa "Edsel".

**CALL for our free catalog!** We

have more products than are listed here.

Prices exclude shipping, handling, taxes.

We also do consulting and development

of special HW, SW and business systems.

CIRCLE 286 ON READER SERVICE CARD



# Feed your Mac.

## Introducing ThunderScan.™

*Now you can turn any printed image into a detailed, high-resolution Macintosh graphic.*



*Just roll your original into your Imagewriter.*



*ThunderScan scans and digitizes the image.*



*Presto! A high-resolution MacPaint document.*

No doubt about it, Macintosh is one great graphics machine. But until now, Mac graphics have been limited to what you can draw with a mouse and what someone else has put on a disk. Consequently, taking full advantage of Mac's graphics capabilities has been tough. But now there's ThunderScan. The new optical scanning device that lets you feed your Mac a steady diet of graphics that are useful to you.

ThunderScan turns Mac's Imagewriter printer into an image reader. So you can digitize any printed image and turn it into a detailed, high-resolution MacPaint document. Anything, including forms, half-tones, photos, mechanical drawings, maps, floorplans, logos, signatures and more. From black and white and color originals. ThunderScan reproduces them at over 200 dots per inch and in 32 shades of gray.

ThunderScan's application software, written by Mac-team-member, Andy Hertzfeld, makes it an extremely versatile and useful tool. You can gen-

erate full-page images or selected parts of them. Enlarge and reduce them. Manipulate them. Control the contrast and brightness. Create your own personal image disk. "Cut" and "paste" images together, creating new documents. And print them out on your Imagewriter. Or send them by modem to another Mac. The possibilities are nearly endless.

***No lights, no camera, just action.***

What you see here is the complete ThunderScan system. You don't have to buy an expensive video camera. Just pop out your Imagewriter's ribbon cartridge, snap in ThunderScan and you're set. It can even work in the dark (maybe you can think of an application for that).

If you bought a Mac at least partly for its graphics, only to find you couldn't take full advantage of them, now you can. With ThunderScan.

At an introductory price of just \$229, it's a small price to pay for a whole new graphics capability.

For more information or a ThunderScan of your own, see your dealer or call us today.

(415) 254-6581

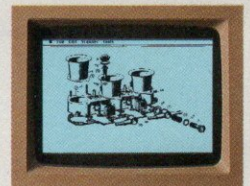

**ThunderScan**

Thunderware Inc., 21 Orinda Way, Orinda, CA 94563

Menucheck:

```
IF MENU(0)=1 THEN ON MENU(1) GOSUB
    sendfile,savefile,done
IF MENU(0)=2 THEN ON MENU(1) GOSUB
    autolog,callwait,dial
RETURN
```

```
' subroutines to handle menu selections
sendfile: F$=FILES$(1,"TEXT"): RETURN
savefile: F$=FILES$(0,"Name to save?"):
RETURN
done: MENU RESET: END
autolog: RETURN
callwait: RETURN
dial: RETURN
```

Note that I've named the subroutines with labels such as `sendfile` and `autolog`, rather than using line numbers. We don't have the space to detail the syntax of the instructions in this listing, but you can see how simply the `MENU` statement creates new menus. The arguments of the `MENU` statement specify where the menu will be located, its activity state, and the commands that should appear. The `MENU` function is equally easy to use to determine which item was selected.

**T**he program will do nothing (i.e., it will idle) until you've made a selection. The `MENU ON` statement turns on "menu event trapping." When you've made a menu selection, the `MENU` function, `MENU(0)` returns the menu that you selected (0 through 20), and `MENU(1)` returns the item within that menu.

Mac-toolbox ROM routines take care of displaying the menu and handling all the menu functions. You have to include the activity that is supposed to occur after a menu selection in your program code, however.

#### Sendfile and Savefile

I've included two other Mac-toolbox routines in this program. The `Sendfile` and `Savefile` subroutines use the `FILES$` function. These subroutines, as I have used them here, store a filename in the variable `F$`.

The `FILES$` function in the `Sendfile` subroutine displays the filenames in a window, with all of the usual accoutrements: a Cancel button, an Eject button, working scroll bars, and even the ability to double-click on a selected file. The `FILES$` function in the `Savefile` subroutine puts an edit

EPSON

## Marry an Epson to your Mac.

**With EPSTART.™ The completely compatible printer driver.**

The perfect couple. Your Macintosh linked to an Epson—Epson reliability, Epson quality reproduction of Apple's ingenuity—all the text, all the timesteps, all the graphics. Even take advantage of Epson's letter quality printing on the LQ-1500 and single-color printing on the JX-80. All you need is EPSTART software for an Epson marriage made in paradise.

\$45 at your Epson dealer. Requires a standard Macintosh printer cable and an Epson MX, RX, LX, FX, JX, or LQ printer with a serial interface. (MX III Graftrax Plus.)



SoftStyle, Inc. • 7192 Kalanianaʻole Hwy. • Suite 205  
Honolulu, Hawaii 96825 • Toll free (800) 367-5600

CIRCLE 313 ON READER SERVICE CARD

## inTOUCH

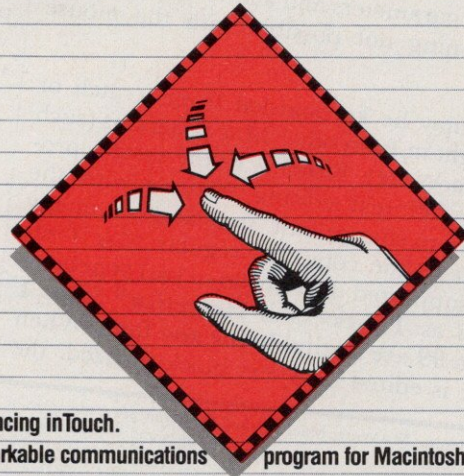

**Announcing inTouch.**

**A remarkable communications program for Macintosh.**

Impressive power. Point and Click simplicity.

*inTouch* transfers information between Macintosh and most other computers with three industry-standard protocols and baud rates to 19,200. Programmable function keys and CCL (Communications Command Language) let you tailor *inTouch* to your situation and automate repetitive tasks. Plus, *inTouch* emulates most popular terminals, including Televideo and VT-100. Get *inTouch*. And you will be.

*inTouch* communications program for Macintosh. \$149.95.

Software Masters, 3330 Hillcroft, Suite BB, Houston, Texas 77057  
(713) 266-5771.

**Software Masters™**

CIRCLE 196 ON READER SERVICE CARD

ReadySetGo™  
ReadySetGo™  
ReadySetGo™

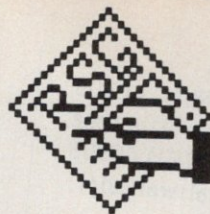

## Interactive page makeup for the Macintosh™

ReadySetGo™ automates the page design and pasteup process, turning the Mac environment into a professional graphic arts publishing system. The system overcomes limitations of current Mac programs (such as MacWrite™, MacPaint™ and MacDraw™) encountered when trying to use those packages for sophisticated page makeup. ReadySetGo is ideal for projects requiring a considerable artistic design component on a page-by-page basis, such as newsletters, reports, forms, flyers, brochures, ads, resumes, letters, papers, presentations and all page proofing and layout design work.

Pages are built dynamically from component blocks which may contain text or graphics. The blocks can be dragged around the page and/or re-sized using the mouse. A ruler shows page dimensions for visual positioning of the blocks but a unique specification sheet gives each block's exact design parameters and allows very accurate positioning not possible with the mouse alone.

Text may be keyboarded from scratch or brought in from other Mac programs (such as MacWrite). Either way, the system provides full text editing features with the ability to change font, style and size at any point in the copy. All regular Mac fonts are supported in addition to real typefaces such as Times™ and Helvetica®. Sizes 1 thru 99 are available for any font! When text is edited or a text block re-sized, the



display instantly updates to reflect changes and text automatically re-fits the block. Graphics blocks can contain rules, borders, solids or pictures. Pictures can be brought in from other programs (such as MacPaint). All graphics automatically scale as their block is re-sized.

Most standard page sizes are supported and a powerful show page facility provides a scaled view of the entire page. The show page display can be kept active concurrently with the actual page and is continually updated as work on the page progresses.

Pages may be stored on disk as full documents (layout plus contents) or as "shells" (layout only). The latter facility allows the reuse of page designs or the building of an inventory of layouts for future projects.

ReadySetGo pages can be printed on the Imagewriter or on the Laser Printer for superb publication quality output.

Macintosh, MacWrite, MacPaint and MacDraw are trademarks of Apple Computer. ReadySetGo is a trademark of Manhattan Graphics. Times and Helvetica are trademarks of Allied Corporation.

Available Now! \$125 from your local  
dealer or order direct from  
**Manhattan Graphics**  
163 Varick Street, New York, NY 10013  
212-924-2778

MasterCard & Visa Accepted

Requires 512K Mac

CIRCLE 288 ON READER SERVICE CARD

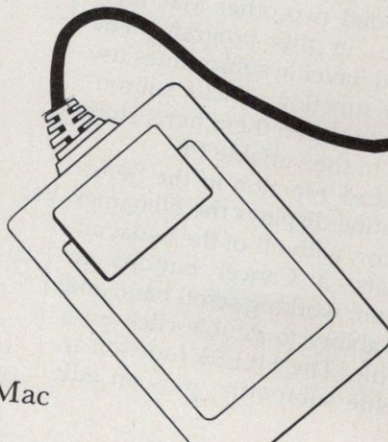

box on the screen along with the usual Macintosh editing features. The first argument determines the action, a 0 produces the dialog box that lets you select and open files, and a 1 produces an edit box.

### Having a Dialog

Dialog boxes are another commonly used Mac feature. The sample terminal program that follows might include them in order to provide phone numbers for different information services (see figure 3 for output).

#### Program 2

```
' dialog box example
PRINT "Dialog box example"
' read stored names
' a real program would probably use a file
nnum=4
FOR j = 1 TO nnum
  READ Na$(j),Nu$(j)
NEXT:j=1
DATA CompuServe,929-5234
DATA The Source,925-8434
DATA Dow Jones,342-4534
DATA Delphi,834-2233

' create dialog window with buttons
WINDOW 2,,(100,100)-(400,200),-4
PRINT "Change phone number"
BUTTON 1,1,"Next",(10,75)-(60,93)
BUTTON 2,1,"Add",(105,75)-(155,93)
BUTTON 3,1,"OK",(200,75)-(250,93)

' idle loop using polling
start:
EDIT FIELD 2,Nu$(j),(10,50)-(250,65)
EDIT FIELD 1,Na$(j),(10,30)-(250,45)
i=1
idle:
  d = DIALOG(0)
  IF d=1 THEN GOTO handlebuttons
  IF d=2 THEN i=DIALOG(2):EDIT FIELD i
  IF d=6 THEN IF j=nnum THEN GOTO done
                    ELSE nextnumber
  IF d=7 THEN i = (1 MOD 2)+1:EDIT FIELD i
  IF i=1 THEN Na$(j)=EDIT$(1)
                    ELSE Nu$(j)=EDIT$(2)
  GOTO idle
' subroutines to handle button selections
handlebuttons:
  ON DIALOG(1) GOTO
nextnumber,newnumber,quit
RETURN
newnumber: nnum=nnum+1: j=nnum:
  GOTO start
nextnumber: j=j+1: IF j>nnum THEN j=1
  GOTO start
quit: WINDOW CLOSE 2:WINDOW 1: END
```



HEWLETT  
PACKARD

ThinkJet

# Marry a ThinkJet to your Mac.

With JETSTART™ The completely compatible printer driver.

Your Macintosh side by side with Hewlett-Packard's 7-lb. portable, ThinkJet. Think of it. Every Macintosh printing capability and Macintosh quality as you jet through the text and graphics at less than a whisper. All you need is JETSTART software for a ThinkJet marriage made in paradise.

\$45 at your Hewlett-Packard dealer. Requires a standard Macintosh printer cable and a ThinkJet serial printer.



SoftStyle®

SoftStyle, Inc. • 7192 Kalaniana'ole Hwy. • Suite 205  
Honolulu, Hawaii 96825 • Toll free (800) 367-5600

CIRCLE 312 ON READER SERVICE CARD

## COPY II MAC™

### • BACKS UP PROTECTED SOFTWARE!

Copy II Mac does more than just sector copy. Its bit copy program has the built-in power and flexibility to handle most protection schemes\* *automatically!*

### • INCLUDES THESE POWERFUL UTILITIES:

- Sector Copy
- Make Files Visible/Invisible
- Sector/File Editor
- Format/Verify Disks
- Repair Damaged Disks
- Copy Protect/Unprotect
- Undelete Files
- Copy Files/Disk

System Requirements: 128K Macintosh, 1 drive.

(Two drives and 512K fully supported!)

\*We update Copy II Mac as often as needed to handle new protections; you as a registered owner may update at any time for ½ price! (To update, just send your original disk and \$20.)

Increase the power of your  
MACINTOSH . . . use **COPY II MAC** ONLY

**CENTRAL POINT**  
Software, Inc.

**\$39.95**

PLUS \$3.00 SHIPPING/HANDLING

9700 SW Capitol Hwy., #100 / Portland, OR 97219

(503) 244-5782  
M-F 8-5:30 (W. Coast Time)



CHECK, COD WELCOME  
(Prepayment Required)

Versions also available for IBM, Apple and Commodore 64!

*These products are provided for the purpose of enabling you to make archival copies only.*

CIRCLE 184 ON READER SERVICE CARD

# CORVUS INTRODUCES SHARED STORAGE. FOR THE REST OF THE OFFICE.

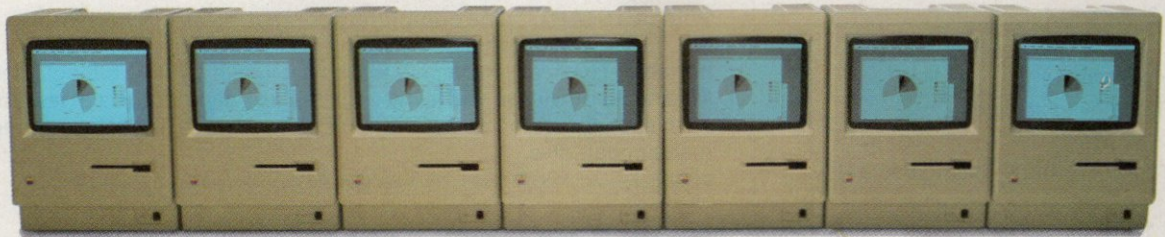

**W**ithout mass storage that every Macintosh can access, your networked office won't have a prayer.

Because you'll still have to share data by swapping floppies.

And just consider

how fast a floppy disk fills up with an entire workgroup compiling data.

To share information, you have to get those floppies neatly stacked, sorted and cataloged.

Something your computer should do for you.

Which is why we've introduced OmniTalk software. It lets you network your Macintosh Office and LaserWriter printer with an OmniDrive hard disk. So you can store all your files in one place. And share information whenever you want, with whomever you want.

Without turning your floppies into little frisbees. Several people can even access the same information at once—something

a floppy could never do. With OmniDrive and OmniTalk, your Macintosh Office has faster access to software and data, greater storage capacity, even easier back-up

capability. Plus, you get three levels of protection to keep your files safe. And with the Corvus 126MB hard disk, it all costs less per megabyte than any other system. You see, Corvus has more experience networking than anyone else. No one offers more, because no one can.

So take it from us. If you're going to add people to your new Macintosh Office, add the mass storage system that everyone can use. OmniDrive from Corvus. Then your Macintoshes can really start talkin' business.

For more information, call (800) 4-CORVUS.



Macintosh is a trademark licensed to Apple Computer, Inc.  
LaserWriter is a trademark of Apple Computer, Inc. OmniDrive and OmniTalk are trademarks of Corvus Inc.

**CORVUS**

CIRCLE 276 ON READER SERVICE CARD



Unlike in the previous example, this program actively checks the status of the buttons with the idle loop, using a technique called polling. Like the menu program, this example uses the EDIT\$ function. It displays the names and phone numbers stored in Na\$( ) and Nu\$( ) and lets you add a new name and phone number.

The BUTTON statements prior to the idle loop create three buttons in the dialog window. Arguments to the Button statement give the buttons' numbers, activity states, titles, size, and location.

The DIALOG(0) function informs the program of the type of dialog event that occurred—button, edit field, go-away box, and so on—and has the purpose here of handling the edit fields as well as the buttons. If someone clicks on a button, the program carries out the selected action. The DIALOG(1) function returns the number of the button that was pressed. Although MS-BASIC (and the Macintosh) take care of flashing the buttons, your program must make the buttons work. Thus, each button has an associated subroutine to effect the action of the button.

The WINDOW statement creates a new window, window 2, in which the dialog occurs. If you press the Cancel button, the program branches to the Quit subroutine, which closes the dialog window—releasing the memory required to maintain it—and reverts to the normal Output window (window 1) before ending. If you don't close windows that you've made, the Mac will resolutely maintain them, even though you are no longer running the program.

### On the Alert

The final example I'll present is an alert box (see figure 4 for output). Alert boxes warn you about certain conditions. For example, you need an alert box in a terminal program to tell you that the number you have just called is not answering or is busy.

### Program 3

' Alert Box Example

' dummy phone number  
Nu\$(i)="929-3456"

' get icon from file  
OPEN "phoneicon" FOR INPUT AS 1  
Icon\$=INPUT\$(LOF(1),1)  
CLOSE 1

' create window with icon, text,

 **HEWLETT  
PACKARD LaserJet**

# Marry a LaserJet to your Mac.

With **LASERSTART™** The completely compatible printer driver.

Your Macintosh teamed with Hewlett-Packard's LaserJet. A combination designed to deliver—super speed, ultra quiet—spectacular graphics and laser quality text, perfect to the letter. All you need is LASERSTART software for a LaserJet marriage made in paradise.

\$95 at your Hewlett-Packard dealer. Package comes complete with software and printer cable.

 **SoftStyle®**

SoftStyle, Inc. • 7192 Kalaniana'ole Hwy. • Suite 205  
Honolulu, Hawaii 96825 • Toll free (800) 367-5600

CIRCLE 221 ON READER SERVICE CARD

## The Color Professionals

### Color Laser-Cut Continuous Feed Paper

*A Cut So Neat they'll think it's Sheet!!*

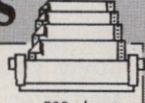
We can make your package any color or size combination you want!  300 sheets 500 sheets  
20 lb. Plain  White  Pink  Green  Blue — In any combination  \$13.00  \$18.00  
22 lb. - 24 lb. Correspondence Quality  12 Shades - White thru Blue  \$15.00  \$20.00

Envelopes to Match Color and Grades of Paper — Call for Prices

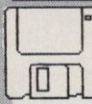

### Diskettes

3½" Diskettes  
Box of 10—in  
Flip-Pak Case! **\$27**

3½" Diskettes avail. at Quantity Discount Prices

10 each - 5¼" SS/SD in Flip Box **\$14**

10 each - 5¼" DS/DD in Flip Box **\$17**

With Labels and Jackets; Color available too!



### Diskette Desk Cases

**NEW!!** Micro Disk Minder 36™  
Holds 36 3½" Diskettes **\$11.00**

### Colored Labels

Keep Your Disks Straight with Colored Labels—Red, Blue, Green, Yellow, Orange, in both 3½" & 5¼" Formats. **CALL!**

**Disk Jackets** MacJackets™ - **NEW!!** Colored Disk Jackets for 3½" Diskettes — Anti-Static, Tough as Nails Tyvek™ Paper for safe transport, and to keep out dust, dirty fingers and spills. — Red, Blue, Green, Yellow, Orange — **CALL!**

• 5¼" Tyvek Jackets — Red, Blue, Green, Yellow, Orange — **CALL!** — We can imprint your logo!

**Imagewriter™ Ribbons** — Black  \$4.50 each • Discounts on Quantities!

We'll ink Ribbons in any Color, or Pack in any Combination:  Red  Blue  Green  Purple \$6.50 each

**MacBag™** — Navy - Black - Grey - Wine - Tan: **\$69.00**

Custom made to hold your Mac and accessories!

**Imagewriter™ Bags** — Also! (10" or 15") **CALL!**

**Mouse Pads** — Keep your Mouse off your

furniture, clean, and with good traction:

Red - Blue - Green - Brown - Grey — **\$8.00 each**

**NEW!** Head Cleaners - Print Head Cleaners - Keep your Computer Creative and Running — We have a full line of computer maintenance products — Is there a product you would like to see us carry? — **CALL!**

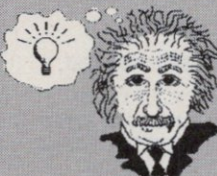



The  
**CREATIVE  
COMPUTER**  
Company

NO SALES TAX!

**CALL TOLL FREE: (800) 325-1529**

OR CALL (800) 555-1212 FOR NEW 800 NUMBER

**HOT LINE: (503) 362-5147**

 **ORDER NOW** 

Shipping, Insurance, Handling at Cost — \$3.00 Minimum

Creative Computer  
620 Elm Street  
Albany, Oregon 97321

All Prices and Information correct to the best of our ability — Prices or availability subject to change without notice

CIRCLE 131 ON READER SERVICE CARD

```

' and buttons
WINDOW 2,,(50,100)-(450,200),4
PICTURE (10,10),Icon$
LOCATE 2,8:TEXTFONT(0)
PRINT Nu$(i);"is busy or not answering."
BUTTON 1,1,"Retry",(240,70)-(300,87)
BUTTON 2,1,"Cancel",(320,70)-(380,87)

' set up dialog event trapping
DIALOG ON
ON DIALOG GOSUB checkbutton
idle: GOTO idle

' handle dialog events
' can be buttons only

```

```

checkbutton:
IF DIALOG(0)<>1 THEN RETURN
ON DIALOG(1) GOSUB redial,quit
RETURN

' subroutines to handle buttons
redial:
LOCATE 2,8:TEXTFONT(0)
PRINT "Dialing ... ";Nu$(i);"
GOSUB dial
RETURN

dial:
' substitute dial code here

```

```

FOR t= 1 TO 1000:NEXT t
LOCATE 2,8:TEXTFONT(0)
PRINT Nu$(i);"is busy or not answering."
RETURN

quit: WINDOW CLOSE 2: WINDOW 1: END

```

This program uses event trapping, as the menu example does, but it acts only on button events, when `DIALOG(0)=1`. Although MS-BASIC does not directly support icons, this program displays one. I created it in MacPaint and transferred it to BASIC by using a file and the `PICTURE$` instruction.

`PICTURE$` converts a MacPaint image into a form that a BASIC program can use. A fully functional program for taking an image from the clipboard, translating it to a string, and writing it to a file appears in the List window of figure 1.

For the alert box, I borrowed the phone icon from MacTerminal. First, I captured the MacTerminal icon in the Finder with `⌘Shift-3`; opened MacPaint; read in `SCREEN0`; captured the phone icon on the clipboard; quit MacPaint; and, finally, ran the program in figure 1.

To use the icon in the alert box, this program first reads the phone-icon file, assigning the contents of the "phone-icon" file to the variable `Icon$`. Once the program has defined `Icon$`, you can use the `PICTURE` command to create the icon.

These few examples should give you some notion of how powerful Microsoft MS-BASIC version 2.1 for the Mac is. MS-BASIC also includes many other features that enable BASIC programmers to create programs that not only are useful or fun but also fully utilize the Macintosh's many unique features. **+**

*Michael Callery teaches computer graphics at the New School in New York and creates instructional software. He is the author of Commodore Magic (E.F. Dutton) and the coauthor of a book on Apple graphics coming soon from Prentice-Hall.*

**PRODUCT INFORMATION**  
**Microsoft BASIC for the Macintosh**  
Microsoft Corporation  
10700 Northup Way  
Bellevue, WA 98009  
(800) 426-9400  
**List Price: \$150; upgrade from version 1.0 or version 2.0, \$50**  
**CIRCLE 359 ON READER SERVICE CARD**

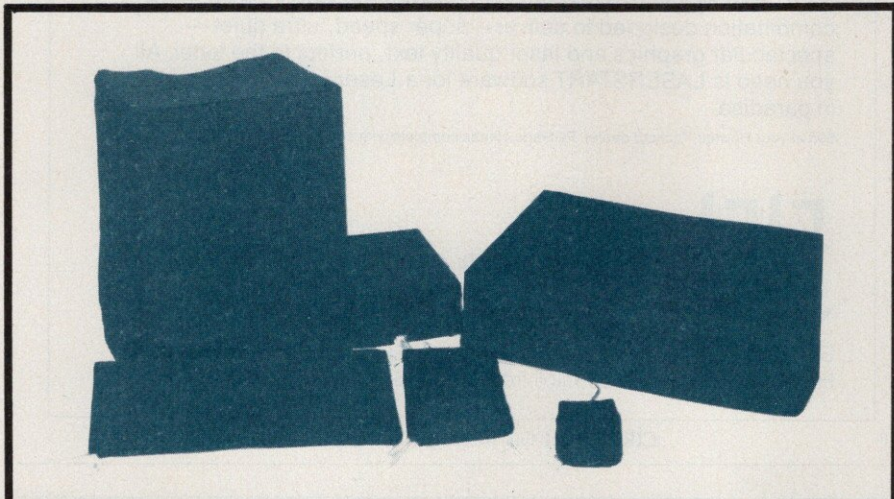

## Mec Enterprises Inc.

Cover your computer in the style it deserves. Introducing the MecCover From Mec Enterprises. Comes in a variety of colors, made of a durable, carefree material. Available in sets or separately. 65% Polyester 35% Cotton, Machine washable.

- |                          |                                       |  |
|--------------------------|---------------------------------------|--|
| Macintosh                | <input type="checkbox"/> Grey         | <input type="checkbox"/> The Macintosh set includes:                               |
| Macintosh XL             | <input type="checkbox"/> Maroon       | <input type="checkbox"/> computer, keyboard, mouse,                                |
| Apple IIE                | <input type="checkbox"/> Khaki        | <input type="checkbox"/> & printer. All sets are. <input type="checkbox"/> \$28.00 |
| Apple IIC                | <input type="checkbox"/> Forest Green | <input type="checkbox"/> Computer cover <input type="checkbox"/> \$10.95           |
| IBM PC                   | <input type="checkbox"/> Navy         | <input type="checkbox"/> Keyboard cover <input type="checkbox"/> \$8.95            |
| IBM PC jr                | <input type="checkbox"/> Brown        | <input type="checkbox"/> Mouse cover <input type="checkbox"/> \$4.50               |
| AT&T PCX                 | <input type="checkbox"/> Rust         | <input type="checkbox"/> External disk drive <input type="checkbox"/> \$6.50       |
| AT&T                     | <input type="checkbox"/> Bluestone    | <input type="checkbox"/> Printer <input type="checkbox"/> \$10.95                  |
| Dealer Inquiries Welcome |                                       | Numeric keypad Mac <input type="checkbox"/> \$6.50                                 |
|                          |                                       | The Bernoulli box <input type="checkbox"/> \$7.50                                  |

Treat your computer with the care it deserves!!!!  
FOR MORE INFORMATION OR TO PLACE AN ORDER,  
CHECK BOXES AND MAIL IN WITH CHECK OR MONEY ORDER  
OR CONTACT: PLEASE ADD STATE SALES TAX

Mec Enterprises Inc.  
P.O. Box 9206 Ogden, Ut. 84409  
(801)392-6663  
PLEASE ALLOW 4 TO 6 WEEKS FOR DELIVERY

NO C.O.D.'S PLEASE  
MACINTOSH, MACINTOSH XL, APPLE IIE, APPLE IIC, ARE ALL REGISTERED TRADEMARKS OF APPLE COMPUTER INC. IBM PC IS A REGISTERED TRADEMARK OF IBM. AT&T IS A REGISTERED TRADEMARK OF AT&T. DIGITAL IS A REGISTERED TRADEMARK OF DIGITAL COMPUTER INC. THE BERNOULLI BOX IS A REGISTERED TRADEMARK OF OMEGA.

CIRCLE 147 ON READER SERVICE CARD

# NORTHEASTERN SOFTWARE

88 Ryders Lane, Stratford, Connecticut 06497

- Up to 50% off/software purchases over \$300 an additional 2% off
- New larger facilities to serve you better
- School & corporate purchase orders accepted
- No additional charges for credit card orders

## Entertainment

Spy Hunter or Buck Rogers	27.00
Tapper or Star Trek	27.00
Congo Bongo or Up 'n' Down	27.00
Sorcerer	27.00
Cutthroats or Zork I	24.00
Zork II, III	27.00
Suspect	27.00
Deadline	29.00
Planetfall	24.00
Enchanter	24.00
Infidel	27.00
Hitchhiker's Guide	23.00
Ultima III	34.50
Lode Runner or Karateka	21.50
Choplifter	22.00
Reforger 88	26.00
50 Mission Crush	24.00
Objective Kursk	24.00
President Elect	24.00
Questron	30.00
Rails West	24.00
Battle for Normandy	24.00
Imperium Galacticum	25.00
Pro Tour Golf	25.00
Ring Side Seat	25.00
Cosmic Balance II	25.00
Computer Baseball	25.00
Geopolitique 1990	24.00
Baltic 85	21.00
North Atlantic 86	21.00
Germany 1985 or Carrier Force	36.00
War in Russia	36.00
Flight Simulator II	32.00
Night Mission Pinball	22.00
Wizardry I	30.00
Wizardry II	21.00
Wizardry III	24.00
Wizardry IV	24.00
Wizprint	16.00
Rendezvous with Rama	25.00
F15 Strike Eagle	22.00
Dragon World or Shadow Keep	25.00
Zaxxon	20.00
Fahrenheit 451 or Amazon	22.00
Expedition Amazon	22.00
The Quest	21.50
Coveted Mirror	21.00
Xyphus	21.50
Transylvania	21.50
Frogger	22.00
BC's Quest for Tires	22.00
Kings Quest	30.00
Wizard of Id Touch Type	19.00
Fax	19.00
Summer Games	27.00
Stellar 7	23.00
Ken Usion's Blackjack	45.00
Caverns of Frietag	20.00
Castle Wolfenstein	20.00
Beyond Castle Wolfenstein	20.00
Millionaire	30.00
Baron	30.00
Tycoon	37.00
Spiritfire Simulator	25.00
Air Sim III	28.00
Bruce Lee	24.00
Sargon III	31.00
Miner 2049er	24.00
Death in the Caribbean	21.00
The Heist	24.00
How about a nice game of Chess 21	21.00
Mask of the Sun	27.00
Hard Hat Mack	24.00
Pinball Const. Set	26.50
Music Const. Set	26.50
The Standing Stone	26.50
One-on-One	26.50
Archon	26.50
Skyfox	26.50
Seven Cities of Gold	26.50
Murder on the Zinderneuf	26.50
Sundog	31.00
Pitfall II	25.00
Gato	24.00
Fantasy	28.00

## Blank Media

Elephant SS/DD	12.50
Elephant DS/DD	21.00
Verbatim SS/DD	17.00
Verbatim DS/DD	24.00
Memorex SS/DD	18.00
Memorex (Mac 3 1/2")	34.00
BASF SS/DD	15.00
Maxell SS/DD	16.00

## Educational

APPLE Logo II	82.00
BARRONS Computer SAT	53.00
CBS	
Mastering the SAT	92.00
Murder by the Dozen	21.90
DAVIDSON AND ASSOCIATES	
Speed Reader II	41.00
Word Attack	29.50
Math Blaster	29.50
DESIGNWARE	
Spellcopier	24.00
Crypto Cube	24.00
Spellikazam	18.00
DLM	
Alison Addition	20.50
Medior Multiplication	20.50
Demolition Division	20.50
Alligator Mix	20.50
Dragon Mix	20.50
EDUWARE (PEACHTREE)	
Compu-Read	17.00
Comp Math	29.00
SAT Word Attack Skills	28.00
PSAT Word Attack Skills	28.00
Spelling B w/Reading Primer	23.00
Algebra 1 2 3 or 4	22.50
Algebra 5 & 6	27.50
Hands on Basic	47.00
Fractions	31.90
Decimals	31.90
HARCOURT BRACE JOVANOVIICH	
SAT	47.00
GRE Test	59.90
HAYDEN SOFTWARE	
Micro Math (Add-Sub)	20.90
Micro Math (Multi-Div)	20.90
LEARNING COMPANY	
Rocky's Boots	30.00
Number Stumper	25.00
Robot Odyssey	30.00
Reader Rabbit	24.00
Magic Spell	22.00
Juggle's Rainbow	16.00
Bumble Games	24.00
Bumble Plot	24.00
Gertrude's Puzzles	27.00
Gertrude's Secrets	27.00
MAGNUM	
Super Speed Reading	65.00
MECA	
Basic Building Blocks	49.00
MICROLAB SAT Programs	20.00
PROGRAM DESIGN	
The New Step by Step	73.00
Step by Step II	73.00
Step by Step III	73.00
SCARBOROUGH SYSTEMS	
Songwriter or Picturewriter	24.00
Phi Beta Philier	24.00
Master Type	24.00
SCHOLASTIC WIZWARE	
Fact & Fiction Tool Kit IIc	24.00
Microzine (1-6)	ea. 24.00
Turtle Tracks	24.00
SPRINKAKER SOFTWARE	
Fraction Fever	19.00
Trains	21.90
Facemaker	19.00
Snooper Troops 1 & 2	27.25
Story Machine	21.90
Kindergarten	18.00
Delta Drawing	31.00
Kids on Keys	24.00
Alphabet Zoo	19.00
Hey Diddle Diddle	17.00
In Search of	25.00
Aerobics	27.00
Grandma's House	19.00
Kidwriter	19.00
SPRINGBOARD	
Early Games For Young Children	21.00
Matchmaker	19.00
Piece of Cake	21.00
Fraction Factory	19.00
SUNBURST	
The Factory	30.00
Teasers by Tobbs	30.00
TERRAPIN Logo	60.00
XEROX	
Sticky Bear ABC	24.00
Sticky Bear Numbers	24.00
Sticky Bear Pop	24.00
Sticky Bear Opposites	24.00
Sticky Bear Shapes	24.00

## Business

APPLE	
Appleworks	Call
Apple Writer IIc	124.90
ARTSCL	
Magic Office Systems	184.50
Magic Calc	93.50
Magic Window II	93.50
ASHTON-TATE DB II	278.00
BPI	
General Accounting	235.00
GL AR AP PR or INV	234.00
CONTINENTAL	
Home Accountant	42.00
Tax Advantage	41.50
FCM/FL	60.50
G/L, A/R, A/P	144.00
DOW JONES SOFTWARE	
The Market Analyzer	208.00
Market Manager	148.00
HAYDEN	
The Writer	34.00
Pie Writer V2.2	93.00
HOWARD SOFTWARE SERVICES	
Real Estate Analyzer II	145.00
KENSINGTON	
Format II Enhanced	91.50
LIVING VIDEO Think Tank II/Ic	86.00
MEGAHAUS	
MegaFinder	98.00
MegaSpell	38.00
MegaWorks	Call
MegaWriter	64.00
MICROPRO	
Wordstar	217.00
Calcastar	48.50
MICROSOFT Multiplan	60.00
MICROSTUFF Crosstalk	115.00
PEACHTREE Peach Calc	91.90
QUARK	
Lexicheck/Word Juggler IIc	118.00
SENSIBLE SOFTWARE	
Sensible Speller	72.00
Bookends	72.00
Report Card	36.50
SIERRA ON-LINE	
The General Manager II	131.00
Homework	43.00
ScreenWriter IIc	78.00
SILICON VALLEY	
The Handlers Package	102.50
List Handler	46.90
The Word Handler II	46.90
SOFTWARE ARTS	
Visicalc Package	114.00
SOFTWARE PUBLISHING	
PFS: Best Sellers	155.00
PFS: Write	72.00
PFS: File	72.00
PFS: Graph	72.00
PFS: Report	72.00
STONEWARE	
DB Master 4 Plus	180.00
Macintosh	
PFS: File	70.00
PFS: Report	70.00
PFS: File/Report	110.00
Typing Tutor III	31.00
Millionaire	24.00
Transylvania	24.00
Coveted Mirror	24.00
The Quest	24.00
Main Street Filer	114.00
Helix	240.00
Sargon III	30.00
MacFiel	30.50
Cart Art	30.00
Home Accountant	57.00
Microsoft Multiplan	115.00
Microsoft Basic	89.00
Microsoft Chart	74.00
Microsoft Word	115.00
Mac the Knife	23.00
Zork I or II	25.00
Zork III	28.00
Master Type	29.00
1st Base	108.00
DB Master (Mac)	115.00
DeVinci (series)	ea. 30.00
Habadox	50.00
TK Solver	145.00

We fully support the Macintosh — call toll free  
Apple Computers — call toll free

## Printers

APPLE	
Imagewriter (10 & 15")	Call
BROTHER	
HR-25	655.00
HR-35	830.00
DAISY WRITER 2000	Call
DIABLO	
620 (RS-232C)	850.00
630 (PC)	1,785.00
DYNAX DX-15	375.00
EPSON	
FX-80	Call
FX-100	Call
RX-80F/T	Call
RX-100	Call
LO-1500	Call
LX-80	230.00
JX-80	Call
Homewriter 10	Call
JUKI 5100	389.00
MANNESMANN TALLY	
MT-160L	605.00
MT-180L	795.00
MT-Spirit	295.00
NEC INFO SYSTEMS	
N2030	680.00
N3530	1,255.00
P2T	665.00
OKIDATA	
Microline 82A	305.00
Microline 83A	535.00
Microline 92P	355.00
Microline 93P	595.00
PANASONIC	
KXP 1090	208.00
KXP 1091	285.00
KXP 1092	388.00
KXP 1093	615.00
PROWRITER	
8510AP	295.00
1550AP	445.00
8510SP	395.00
QUIME Printers	Call
SILVER REED	
EXP400	240.00
EXP500P	275.00
EXP550P	395.00
EXP770P	700.00
STAR MICRONICS	
SG 10	234.00
SG 15	394.00
SG 20	485.00
SR 15	585.00
SD 10	345.00
SD 15	468.00
TOSHIBA Printers	Call
TRANSTAR	
120P	425.00
130P	550.00
315	455.00
Pics Card	95.00

## Disk Drives

APPLE	
Disk II Drive	295.00
Duo Disk w/acc. kit	Call
Pro File Disk Drive	Call
IIc Add-On	Call
Mac Add-On	Call
INFAX	
101 10 Meg	2,145.00
102 20 Meg	3,350.00
INDUS GT Slimline	250.00
MICRO SCI	
A2 143K	188.00
Slimline IIc	184.00
Slimline IIIc	188.00
Micro SCI Controller	57.00
QUENTIN	
AP 100A Full Height	198.00
AP 105 Slimline	209.00
AP 110A Twin Pack	410.00
RANA	
Elite I	195.00
Elite II	355.00
Elite III	428.00

## Monitors

AMDEK	
Color 300	235.00
Color 500	395.00
Color 600	415.00
Video 300G Green	128.00
Video 300A Amber	138.00
DVM II or III	130.00
BMC	
Color Plus Monitor	239.00
BM12 AOW Green	95.00
PANASONIC	
TR 120 Green	145.00
TR 120 Amber	150.00
DTD 1300 RGB	400.00
PRINCETON	
HV-12	469.00
RGB Interface	155.00
SAKATA	
SC-100 Color	244.00
SC-200 RGB Color	454.00
SG-1000 Green	94.00
TAXAN	
Green (Hi-Res)	119.00
Amber (Hi-Res)	125.00
210 "3" Color (Lo-Res)	283.00
RGB Vision III	398.00
410-64 RGB-2 Interface	184.00

## Specials

EDD III	45.00
Locksmith 5.0	66.00
CIA Files	47.00
Back Up III	52.00
Copy II+	21.00
Wildcard II	98.00
Dollars & Sense/Mac	87.00
Copy Master II	Call
Copy Mac	24.00
Megaworks	Call
Network Wiretree	46.00
Apple Joystick	Call
Apple Mouse	Call
Apple Super Serial Card	115.00

## Home/Accessories

Pixit	30.50
Take One	36.50
Apple Mechanic	17.00
Beagle Basic	20.00
Beagle Graphics	33.00
Disk Quick	18.00
Doss Boss	14.00
Double Take	20.00
D-Code	23.00
Fat Cat	17.00
Flex Type	17.00
Frame Up	17.00
GPLE	28.00
I/O Silver	17.00
Pronto Doss	17.00
Silicon Salad	13.00
Triple Dump	24.00
Type Trax	11.00
Utility City	17.00
Zoom Graphics	31.00
Visible 6502	32.00
Crossword Magic	31.00
Turbo Pascal	33.00
Net Worth	49.00
Bank Street Writer	41.00
Bank Street Speller	41.00
Bank Street Filer	Call
Print Shop	28.00
Graphics Library	15.00
Digital Paint Brush	198.00
Forecast	38.00
Time Trax	37.00
DATA TRANSFORMS Fontrix 1.5	58.00
Font Paks 1-11	ea. 11.50
The Accountant	60.90
Cut & Paste	34.00
Financial Cookbook	34.00
FUNK Sideways	63.00
Orca II	54.00
LAZERWARE Lisa V 2.6	54.00
Applesoft Compiler	110.00
Typing Tutor I	15.00
Typing Tutor III	31.00
Dollars & Sense	59.00
Dollars & Sense IIc	70.00
The Graphics Magician	48.00
New Complete Graphics System	48.00
Paper Graphics	31.00
Cat Graphics	22.00
QUALITY Bag of Tricks	25.00
Merlin	37.00
Merlin Pro	44.00
Merlin Combo	66.00
SOFTRONICS Softerm II	123.00
TURNING POINT Time is Money	51.50
ASCII Pro	78.00
Micro Cookbook II/Ic	29.00
Hayes Mach II	34.00
Hayes Mach III	29.00
Kraft Joystick	32.00
TG Joystick	9.00
TG Select-A-Port	28.00
Micromodem IIe/w SC I	130.00
1200 Baud Modem	398.00
KENSINGTON System Saver	63.00
KEYTRONICS Keyboards	245.00
Koala Pad	75.00
Nuggie Learning Keys	44.00
The Gibson Light Pen	158.00
MCT Speed Demon	218.00
Ram Card	68.00
SoftCard II	26.00
Apple Cat II	193.00
212 Apple Cat II	373.00
ORANGE MICRO Grappler plus	Call
Buffered Grappler	119.00
PICASSO w/interface	31.00
PROMETHIUS Pro Modem 1200	358.00
PROMETHIUS Internal IIe/IIc	305.00
SATURN 128K Ram Card	215.00
Accelerator IIc	Call
Poppom Modem (1200)	Call
Nice Print	125.00
The Cricket	125.00
Echo II+	94.00
Mockingboard "A"	74.00
Mockingboard "B"	76.00
Mockingboard "C"	128.00

You  
already  
own  
the  
ultimate  
computer

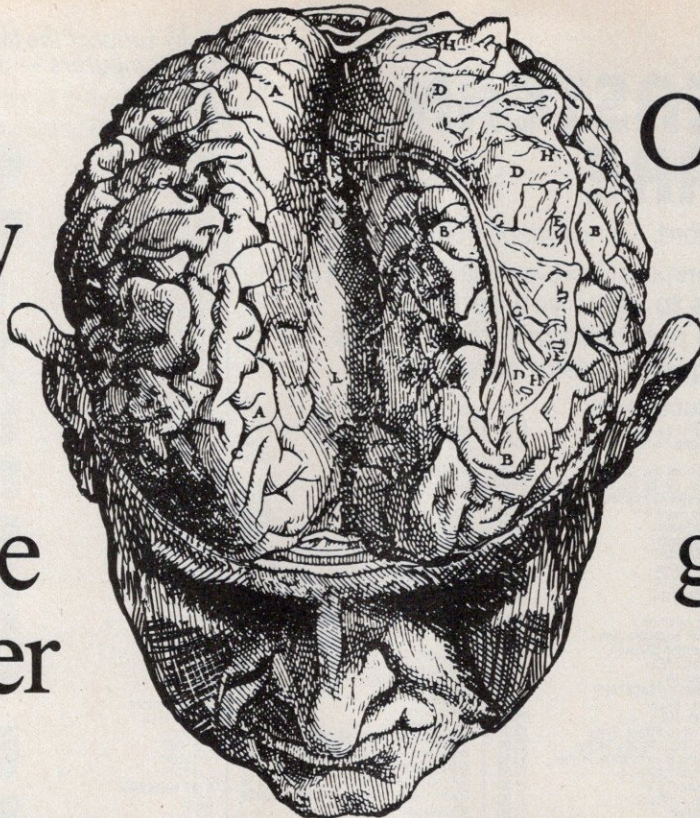

Operate  
it  
like  
a  
genius  
with...

# CONSULTANT™

*helps you use your whole brain to think and work more productively.*

... a new concept software program for the Apple® Macintosh™ 128 or 512.

YOU ARE NOT ALONE. Your CONSULTANT™ is always ready to stimulate and supplement your own magnificent mind. CONSULTANT™ helps: detectives solve mysteries, scientists discover principles, engineers create products, generals plan strategies, salespeople develop proposals, executives make decisions, managers supervise, auditors generate reports, lawyers persuade juries, doctors diagnose symptoms, teachers grade exams, writers develop concepts, missionaries make converts, homemakers plan their day and students learn to think. CONSULTANT™ is for any knowledge worker who must solve problems, plan projects, develop expert systems, get results, report their progress and continually grow in their profession.

*ALL FOR A SUGGESTED RETAIL PRICE OF \$200  
THE COST OF A FEW HOURS OF A  
HUMAN CONSULTANT'S TIME*

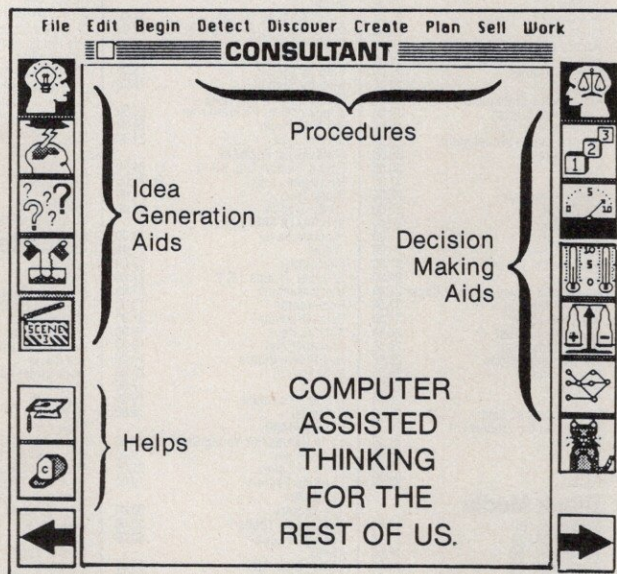

See your local software dealer or contact us for a free brochure.

**ODS, Inc.** — Organization Development Software  
1605 S. Garden St., Palatine, Illinois 60067  
**(312) 397-1684**

Macintosh is a trademark licensed to Apple Computer, Inc. CONSULTANT is a trademark of ODS, Inc. Copyright 1985, ODS, Inc. All rights reserved.

CIRCLE 327 ON READER SERVICE CARD

## A LOOK AT THE NEW

# Finder and MacForth

**W**ith much regret, I must announce that this is the last of my "Mac According to Hogan" columns.

Simply put, I find I don't have enough time to research and write the kind of quality material I think Macintosh users need. To all the readers who have written to me to thank me for things I've said in my column, thank you, and may your further Macintosh journeys be rewarding.

For this final column, we have two programs I think you should know more about, the new version of the Mac Finder and MacForth Level 2.

### Finder's Keepers

This summer looks like a busy one for Apple, at least as far as software is concerned. At long last, we'll see MacDraw, MacBASIC, and the development system, and new versions of the Finder and MacWrite will also be available. For good measure, there's Andy Hertzfeld's Switcher program, which allows multiple programs in memory simultaneously (if you've got the memory—512K or more). From what I've seen in each of these programs and updates as they near final release, I can come up with only

### And an annotated chart of Macintosh programming languages

one comment: It's about time.

The new Finder we've seen is version 4.1, and it is significantly improved in several respects. You can now shut down the system (i.e. save all folders and eject all diskettes) in less time by choosing the new Shut Down command from the Special menu (see figure 1). It takes only three seconds, by my count.

Loading files and moving from application to application is also faster. Hard-disk support has been improved, and the Finder can now work better with many files in a single directory.

Included in the version of the new

Finder I saw was something called the miniFinder. It is a simplified program-selection system that can move you around more quickly but still makes use of some of the Macintosh graphic abilities (see figure 2 for a typical miniFinder display that I set up on one of my utility disks). Getting to the miniFinder is faster when you're booting than waiting for the whole Finder to take charge. The miniFinder looks like a nice enhancement that I'll make use of on my development-tool disks.

Also new in the Finder are some additional items in the File menu. You'll find that New Folder, Page Setup, and Print Catalog have been added to this menu. New Folder creates a new, empty folder; the new Finder no longer requires that an empty folder be on every disk even if you'll never use it (just one more thing to clutter



Figure 1: The Finder's new Shut Down command

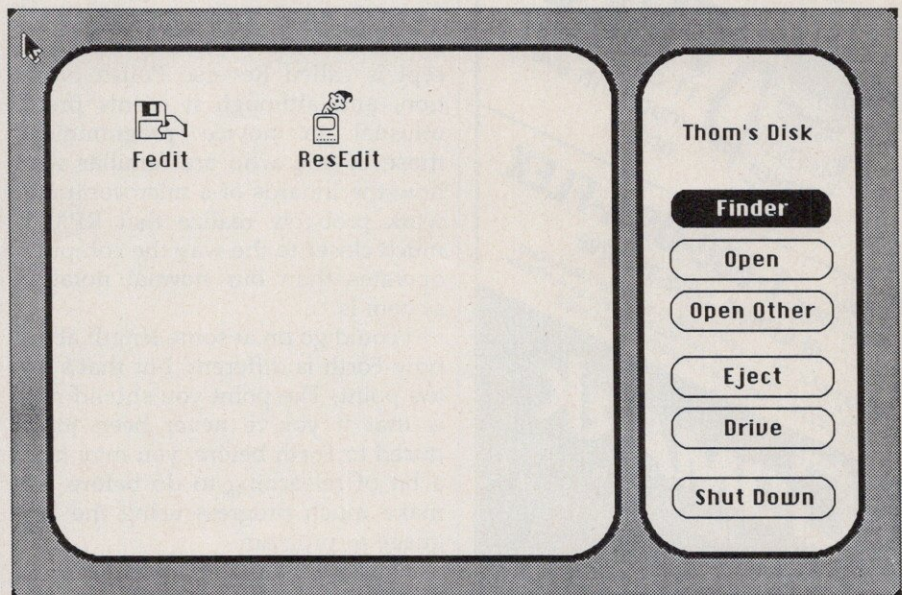

Figure 2: A typical miniFinder display

**LOOK**  
AT THESE PRICES!



**maxell**

Get 100% error-free certification and a lifetime warranty from Maxell. In tests simulating 20 to 30 years of use Maxell diskettes showed no sign of wear or data loss. You're assured of reliability with Maxell's lifetime diskette warranty.

3 1/2" Single Sided/  
Double Density  
Minimum Order 50 Diskettes.

50 +	100 +
\$3.24	\$3.15



**FREE**  
11 oz. porcelain  
mug with every  
order!

CALL  
TOLL FREE **1-800-USA-FLEX**  
IN ILLINOIS 1-312-351-9700

Please mention this ad when calling in your order. MasterCard, Visa, C.O.D. or net 30 days with approved credit on purchases over \$200.00. Prices subject to change without notice.

**COMARK**  
COMARK, INC. 135 N. Brandon  
Glendale Heights, Illinois 60139

up the display). Page Setup does the usual printer-driver-setup things, and Print Catalog does in the Finder what Print Catalog does in MacPaint: It prints a catalog of the indicated disk, complete with icons and filenames.

One thing that does not show on the display but certainly shows when you're using the new Finder is that on a 512K Macintosh, all those resources that the Finder used to swap in and out of memory are now stuck into memory automatically by the Finder. No more waiting patiently for some of those dialog boxes, controls, or font changes, at least for us 512K owners.

All in all, even though the changes in the Finder don't seem major, Apple has done a good bit of reworking, and the subtle changes will make life more bearable on the desktop.

**A**

s they once said on British television: "And now for something completely different." Forth is about as different a computer language as you'll find.

In Forth, you can program interactively by typing commands and getting immediate response (interpreted languages work this way), or you can type lines of program code, using an editor, and then have the language prepare and execute your code all at once (a process that is similar to compiling).

To perform math functions in Forth, you don't tell it things like 2 + 2 (which equals 4) but instead tell it 2 2 + (which still equals 4). This concept is called Reverse Polish Notation, and although it seems pretty unusual to novice programmers, those of you who are familiar with how the innards of a microcomputer work probably realize that RPN is much closer to the way the computer operates than our normal notation system is.

I could go on at some length about how Forth is different, but that's not the point. The point you should note is that if you've never been introduced to Forth before, you may have a bit of relearning to do before you make much progress using the language to program.

Creative Solutions, the maker of MacForth, was one of the first companies to provide any programming

tools for the Mac, let alone high-quality ones. At the 1984 West Coast Computer Faire (about two months after the Mac's introduction), the firm introduced Level 1 MacForth.

Level 1 MacForth is a complete version of Forth that, Creative Solutions says, is suited for hobbyists as well as people who are just beginning to learn to program the Macintosh. Besides the usual things you expect to find in Forth, Level 1 includes some rudimentary graphics routines (rectangles, ovals, arcs, wedges, and rounded rectangles, among others) and access to the most useful toolbox routines. Level 2, which was released a month or two later, is geared toward professionals and includes some advanced graphics routines (polygons, regions, pictures), some floating-point-number routines (not usually available in basic versions of Forth) support for in-line assembly language, and the rest of the toolbox routines necessary to program the Macintosh's every bell and whistle.

A third level is available for those who want to turn their MacForth programs into commercial applications that hide Forth (other than including a message that the programming language was MacForth). You don't have to pay royalties to Creative Solutions if you use Level 3 Forth to create a product, although you will have to include some information about MacForth in your product in return for the no-royalty policy.

You can buy any level of MacForth and upgrade later to a higher level for the difference in price (Level 1 is \$149, Level 2 \$249, and Level 3 \$499). Personally, I think that Level 2 is almost a necessity for doing any serious programming, since you won't be able to do some basic things such as using TextEdit or any controls with Level 1. Nevertheless, Creative Solutions' upgrade policy makes it easy to test the waters, so to speak.

And nice waters they are. MacForth comes with a simple tutorial, Going Forth, that will get you past that first, shy, stage most of us have when we're trying to learn something new on our computers. I found the tutorial good but wished there had been more to it. Also included are a few sample programs, mostly in the form of simple graphics demonstrations. Listing (and editing) them will show you just how easy it is to program the Macintosh.

Here's the code you use to create a

# IT WAS HER EYES...



... that tipped me off. They looked out through the fancy fur and perfume and told me something was wrong, dead wrong. I'd seen those eyes somewhere, in some long forgotten place, some dingy nightclub on the south side of Chicago. But here she was, strictly East Side Manhattan, if you catch my drift.

She was askin' me to stick my neck out for the long green, but a nasty feeling made me think twice before I made my move. I had to put those eyes to a face, and fast. The solution was on my desk: MAC PRIVATE EYE™. One quick call to my inside man at headquarters was all it took. Within seconds he copied the mug shot with his MAC PRIVATE EYE video digitizer, modemed it straight to my Macintosh™ and put the I.D. on this dame. The \$595.00 I spent on that MAC PRIVATE EYE probably saved this flatfoot from some serious trouble. One thing WAS clear, my

MAC PRIVATE EYE would never leave me short for important information like maps, graphs, blueprints, photos, security I.D.'s, and a thousand other things I hadn't thought of yet. There was only one question; how did I ever get along without it?

For more information:  
I/O Video Inc., 225 Third St.  
Cambridge, MA 02142 (617) 547-4141  
Dealer and Distributor inquiries welcome.

**Mac  
Private eye**™

From I/O Video,  
for computer owners with vision.

Macintosh is a trademark of Apple Computer Inc.  
Mac Private Eye is a trademark of I/O Video Inc.  
CIRCLE 141 ON READER SERVICE CARD

new window, for instance:

(New Window Setup)

NEW WINDOW SHEET

```
"My Window "      SHEET W. TITLE
10 10 200 200    SHEET W. BOUNDS
SIZE BOX CLOSE BOX +
                SHEET W. ATTRIBUTES
SYS WINDOW      SHEET W. BEHIND
SHEET ADD WINDOW
```

SHEET in the above example is simply a pointer to our window definition. Most of the rest of this simple example should be self-explanatory if you've read *Inside Macintosh*.

Other Macintosh-toolkit goodies

are just as easy to use. Indeed, one of the aspects I like about Forth as a learning language for potential Macintosh programmers is that you can try things out interactively, watching what happens at each step.

The editor that comes with MacForth works pretty much like MacWrite does, except that it scrolls one Forth block (16 lines of code) at a time. Forth programmers are used to working in blocks, so they won't be put off by not having continuously-scrolling text entry, but I, having been raised primarily in the Pascal realm of languages, would have appreciated

not always having to think in blocks of 16 lines.

The editor includes the ability to date-stamp the file you're editing and manipulate whole blocks at a time (as in erasing a block for reuse). Invoking the editor from Forth is as simple as typing the block number you want to edit and the word EDIT—10 EDIT, for instance.

Again, note that Forth wants you to specify the numbers it is to work with before you tell it what to do with those numbers (more RPN).

Two things distinguish MacForth from many of the other languages

## AN APPRAISAL OF

COMPANY	PRODUCT	COMMENT	RS NO.
Absoft Corporation 4268 North Woodward Royal Oak, MI 48072 (313) 549-7111	MacFORTRAN	<i>Full ANSI FORTRAN 77 compiler with debugger. Full toolbox interface.</i>	395
Apple Computer, Inc. 20525 Mariani Avenue Cupertino, CA 95014 (408) 996-1010	Macintosh Pascal Mac BASIC Development System Assembler	<i>Good learning language. Not very BASIClike, but almost a pseudo-Pascal; I'd recommend MacPascal instead. <b>The assembler system.</b></i>	396
Consulair Corporation 140 Campo Drive Portola Valley, CA 94025 (415) 851-3849	Mac C Compiler	<i>Very good, as far as it goes; integrates well with MDS assembler.</i>	397
Creative Solutions 4801 Randolph Road Rockville, MD 20852 (301) 984-0262	MacForth Level 1 MacForth Level 2 MacForth Level 3	<i>Excellent all-around.</i>	398
ExperTelligence 559 San Ysidro Santa Barbara, CA 93108 (805) 969-7874	ExperLogo ExperLisp ExperOPS5	<i>A powerful extension of the Logo computer language. The first complete implementation of LISP on a microcomputer. Complete implementation of OP5 expert-systems building tool.</i>	399
Hippopotamus Software 985 University Avenue Los Gatos, CA 95030 (408) 730-2601	Hippo-C Level 1 Hippo-C Level 2	<i>Good for newcomers to C.</i>	400
Kriya Systems, Inc. 505 N. Lake Shore Drive Chicago, IL 60611 (312) 822-0624	Neon	<i>A Smalltalk-like environment that offers an object-oriented language, with execution speed of Forth.</i>	401
MainStay Software 28611B Canwood Street Agoura Hills, CA 91301 (818) 991-6546	MacASM (assembler)	<i>First assembler available for Mac, but I haven't tested.</i>	402



available for the Macintosh. First, the manuals, both for Level 1 and Level 2, are clear, explain Macintosh programming rules much better than any others I've seen, and are well indexed and cross-referenced. Even though the MacForth manuals do not try to teach you Forth, the Level 2 manuals total more than 500 pages. I could not find any undocumented (or even poorly documented) commands, and, again, the indexing is complete and accurate.

Second, MacForth is supported by a special users' network on CompuServe (GO PS64 is the command to

get to it). You use a supplied program, Terminal, written in MacForth, to call CompuServe. Once you've joined the special-interest group serving MacForth, you'll have access to lots (and I mean lots) of sample source code, discussions of problems encountered and how to get around them, plus general chitchat with other MacForth users. In addition, you can pose questions to Creative Solutions personnel who monitor the bulletin board.

I know of no other language for the Macintosh computer that is as fully developed and well explained and comes with such complete support. If

you're serious about programming the Mac, you owe it to yourself to look at MacForth.

#### Roundup Time

Since this is the last column, I thought it appropriate to include a roundup of the languages that are available for the Macintosh, which you'll find in the accompanying annotated chart. **+**

*Thom Hogan is the editor-in-chief of Business Software and is the author of numerous computer books, including InfoWorld's Essential Guide to the Apple II.*

## MACINTOSH LANGUAGES

COMPANY	PRODUCT	COMMENT	RS NO.
Manx Software Systems P.O. Box 55 Shrewsbury, NJ 07701 (800) 221-0440	Aztec C68K	<i>Reportedly fast, but doesn't use Mac interface when compiling.</i>	403
Megamax, Inc. Box 851521 Richardson, TX 75085 (214) 987-4931	C Compiler	<i>Just received. Appears to be faster than all but Manx, and includes some things that Consulair does not.</i>	404
Microsoft Box 97200 Bellevue, WA 98009 (206) 828-8080	Microsoft BASIC 2.1	<i>Good standard BASIC with decent access to many Mac features.</i>	405
Modula Corporation 1673 West 820 North Provo, UT 84601 (800) 545-4842	Modula 2	<i>For serious Pascal programmers, here's a language that will take you beyond what MacPascal or Lisa Pascal can do.</i>	406
Pterodactyl Software 200 Bolinas Road #27 Fairfax, CA 94930 (415) 485-0714	PC BASIC Compiler	<i>A BASIC compiler for the LISA (Mac XL), under the Pascal workshop, compatible with IBM PC BASIC.</i>	407
Softtech Microsystems 16875 West Bernardo Drive San Diego, CA 92127 (619) 451-1230	MacAdvantage UCSD Pascal	<i>Entry-level Pascal with development tools and utilities.</i>	408
	UCSD Pascal	<i>Full-scale development system.</i>	
	FORTTRAN 77	<i>A complete implementation of the 1977 ANSI version of FORTRAN.</i>	
Softworks Ltd. 2944 North Broadway Chicago, IL 60657 (312) 975-4030	SW Professional C Compiler	<i>Whitesmith's C for the Mac. I like it a little less than the Consulair version, but it's still worth looking at.</i>	409

# CRYSTALWARE

**"TAKE YOUR MAC TO THE LIMIT...AND BEYOND!"**

Crystal has been a leading producer and certified developer of Apple software since 1979. They produced the first graphic adventure for the Apple...House of Usher and the grandfather of all adventure games, the six-disk Fantasyland 2049 A.D. In 1981 John and Patty Bell and Mike Potter produced Protector which was a major hit in the arcade software market. Crystal currently has more than 65 titles available which run on a dozen micros.

The Mac has incredible graphics and memory. Some of our games take up as much as 1 million bytes, include dazzling graphics and sound, and will give your Macintosh a run for it's money. We also produce a fine line of business packages and graphics utilities.

## WIZARD OF ZEN

A children's anthology with Tic-Tac-Toe, Hangman and Grumpus. It's a series of Fantasy Tales for bedtime reading and an educational graphic adventure called the Wizard of Zen where you go inside a computer to the Land of Zen. Also includes Mr. Key to help young users learn about the keyboard and how to use it.

Now Available! \$29.95/disk

## GHOST MANSION

Enter the creepy old Ludwig estate with its hundreds of rooms, forests, garden path, a vast cemetery and crypt, and a host of vampires, werewolves and secret passages. Even compiled, this game takes up more than 320,000 bytes on disk. A challenge for even the most seasoned adventurer with a "save game" feature so that you may play this game in more than one sitting. In the development of this game, it took our Macintosh more than an hour to display all the castle and grounds, with each display generated in only a few seconds. We are offering a prize of \$100 for the first person to solve the mystery and send in their solution by certified mail! Now Available, also available for the Apple IIe & IIc!

\$49.95/disk

## ZARDON- JOURNEY TO THE CRYSTAL PLANET

Somewhere in another galaxy far, far away is the legendary Crystal Planet. It is a voyage of many centuries through the uncharted regions beyond the Galactic Frontier. Besides a clever captain you must also be a shrewd trader for it is impossible to take enough supplies for your quest so you must acquire goods and additional gold and silver along the way. This game is the forerunner of the later to be released Galactic Expedition. It contains incredible high speed graphics, a great deal of animation, and is unlike anything currently on the software market. Now Available!

\$49.95/disk

## CRYELL - THE PATHFINDER

Imagine a fantastic voyage through the human body in a miniature submarine the size of a pin-head. Imagine being able to travel through the human circulatory system and battling amoebic antibodies with your onboard laser while piloting your ship through a fascinating 3-D animated color simulation. Picture if you will, another dimension of adventure in sight and sound and color. You have just begun to experience Cryell-the-Pathfinder. Now Available!

\$39.95/disk

## GOPHER

Deep in the earth, lurking in a labyrinth of tunnels beneath Uncle John's garden, lives Henry the Gopher. As you tunnel through earth you must avoid falling rocks and set traps for the Veggie Bandit.

Now Available! \$29.95/disk

## POOR JOHN'S ALMANAC

This is the first of our series of practical business application programs, inspired by requests of our Midwest users. It includes a wealth of information on agriculture, animal husbandry, and farming. It also has an inventory control package and more information on AGRINET, our online information service on current meat and grain prices. We have received enormous support already for this package but still could use a lot more information. If you are currently involved in this industry and would care to share your knowledge, we would be pleased to hear from you in writing or by phone.

Now Available! \$49.95/disk

All products come with a lifetime guarantee / use the finest media / and are thoroughly tested. There are now more than 38 programmers working for Crystalware and we are always looking for more talented hackers. We pay royalty fees from 15% to 25% of the gross sales price.

- \* To place an order send check or money order to:  
Bell Digital / Crystalware Corporation  
5647 So. 6th St., Klamath Falls, Oregon 97603

Call toll-free in the US (800)-848-8088 or in Oregon call (503) 882-0024

- \* If you are interested in more information, send \$3.00 and we will send you a copy of Crystal Vision, which includes detailed descriptions of our 65 products.
- \* If you would like a demo with your catalog, send \$20.00 and you will receive a years subscription to Crystal Vision, a lifetime membership in the International Crystal Users Group, and of course a demo disk.

Our order lines are now open 24 hours/day, 7 days/week  
(We now also accept VISA, MASTERCARD, and AMERICAN EXPRESS)

CIRCLE 213 ON READER SERVICE CARD



# Straight Talk.™

## The information software that keeps you on course.

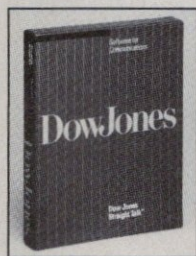

You don't go sailing without the right navigational instruments. And you don't make business decisions without the right information. Straight Talk and your Macintosh™ give you access to a world of timely information. Fast. So you have the information you need to make informed business decisions.

### Here's what it gives you:

- Automatic log-on and log-off to major information services like, Dow Jones News/Retrieval,® The Source<sub>SM</sub>, and CompuServe.
- The latest business information and financial news, plus airline schedules and fares, an encyclopedia, electronic mail and much more.
- Ability to review, save, edit and copy data received online *after* you hang up.
- Communication with other Macintosh computers via modem or networking.

And at \$95, Straight Talk is the least expensive, most diligent electronic know-it-all you'll ever come across.

Straight Talk is the precision instrument designed to make sure your ship comes in.

### Special Offer!

For a limited time, order Straight Talk at \$95 and get 5 hours of **free time** on Dow Jones News/Retrieval (approximately \$100 value). To order, see your local computer dealer\* or call:

**1-800-257-5114**, ask for John Austin.

(In New Jersey, Alaska, Hawaii and Canada, call 1-609-452-1511)

Please have your credit card information ready, including expiration dates. VISA, MasterCard, and American Express accepted.

**Act now** — Offer expires July 31, 1985.

\*To redeem offer send proof of purchase to Dow Jones & Company, Inc., John Austin, P.O. Box 300, Princeton, N.J. 08540.

Straight Talk works with Apple® Macintosh.™

**Dow Jones**™  
**Software**  
For Informed Decisions

*"I think we turn left here."*



## APRICORD IIc PRINTER INTERFACE

Apricorn has introduced a line of ApriCord products that includes the ApriCord IIc, a parallel printer interface that enables you to connect many Centronics-compatible parallel-interface printers to the serial-interfaced Apple IIc. The interface requires no external power supply and is housed within an injection-molded case. It comprises a DIN-5 serial connector and a six-foot cable with connector and Centronics-type printer connector. (List Price: \$79.95)

**Requires:** Apple IIc  
Apricorn  
7050 Convoy Court  
San Diego, CA 92111  
(619) 569-9483

CIRCLE READER SERVICE NO. 550



## ADVANCED BUSINESS ACCOUNTANT

A business-accounting system for Apple II computers. The Advanced Business Accountant can perform book-keeping functions for up to 50 companies. The double-

entry system can convert data to AppleWorks files for use with the AppleWorks database and spreadsheet programs.

Systems now available are General Ledger, Accounts Payable, Accounts Receivable, Inventory Control, and the System Manager. Each system can be used alone or can be integrated with the General Ledger. The only required system is the System Manager, which includes a mailing-labels program.

The General Ledger can maintain up to 1000 user-defined accounts and 20,000 monthly journal entries. Accounts Payable can handle 10,000 vendors and an unlimited number of transactions each month. The Accounts Receivable system tracks information for up to 10,000 customers and tracks and reports on sales for each sales representative. Inventory Control can handle information on up to 10,000 items, including year-to-date issues, receipts, and adjustments. (List Price: System Manager, \$95; all other systems, \$395 each)

**Requires:** Apple IIe or IIc,



The Smart Switch Box, SSB1000, enables users to connect a modem and two peripherals to a single computer.

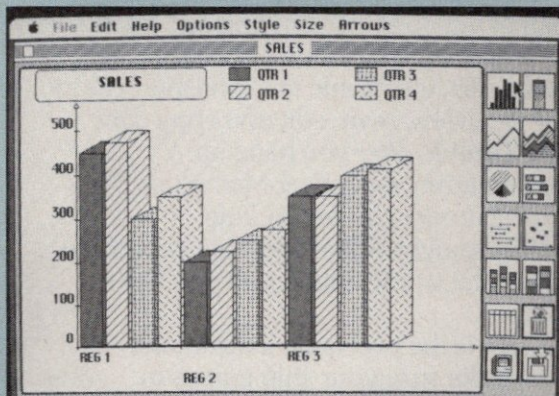

Ensemble, a business-software package for the Macintosh, includes a Charting feature with ten standard charts.

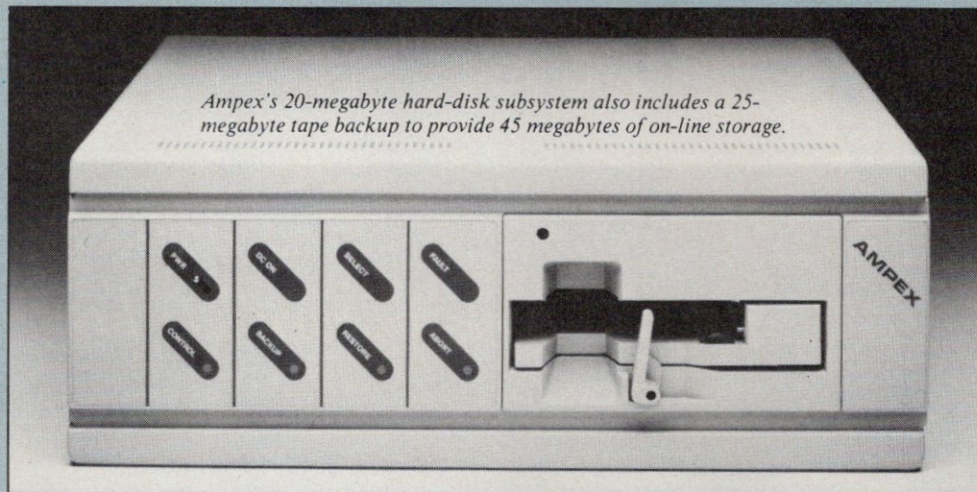

AmpeX's 20-megabyte hard-disk subsystem also includes a 25-megabyte tape backup to provide 45 megabytes of on-line storage.

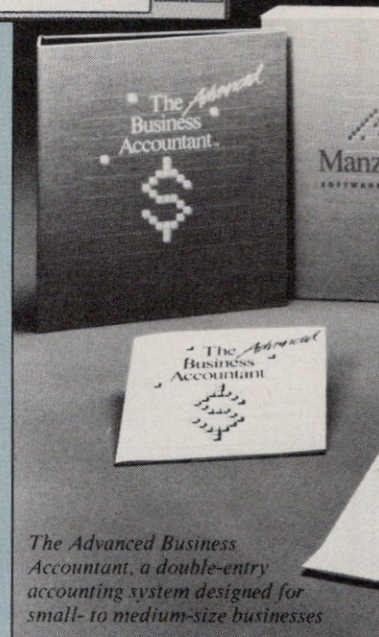

The Advanced Business Accountant, a double-entry accounting system designed for small- to medium-size businesses

ProDOS, hard-disk drive  
Manzanita Software  
Systems

One Sierra Gate Plaza  
Suite 200-A  
Roseville, CA 95678  
(916) 781-3880

CIRCLE READER SERVICE NO. 551



### ▶ SMART SWITCH BOX, SSB1000

The Smart Switch Box is a new and easy way to connect a modem and two peripherals to a single computer. The box has one

The ApriCord IIc Parallel Printer Interface, from Apricorn

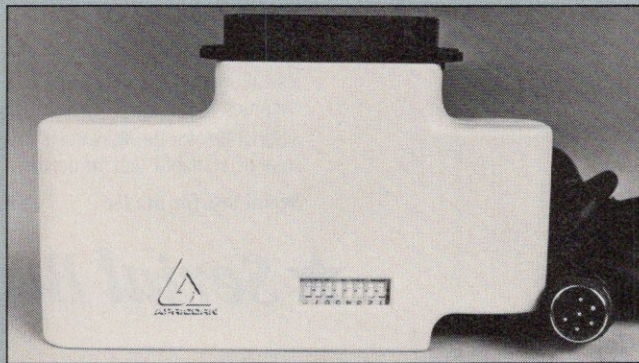

computer port and three peripheral ports—one dedicated to modems and the other two for printers, plotters, and terminals. Logic circuitry makes the correct RS-232 interconnection between virtually all computers and peripherals, and the box also indicates which piece of equipment is disabling data transfer when this problem occurs. The package includes two 6-foot ribbon cables with both male and female DB25 connectors. (List Price: \$159.95)

IQ Technologies, Inc.  
11811 N.E. First Street  
Suite 308  
Bellevue, WA 98005  
(206) 451-0232

CIRCLE READER SERVICE NO. 552

tion management, report generation, calculations, decision analysis, 2-D or 3-D graphing, and mail and list management to produce attractively finished business documents. (List Price: \$299.95)

**Requires:** Macintosh  
Hayden Software  
Company, Inc.  
600 Suffolk Street  
Lowell, MA 01854  
(617) 937-0200

CIRCLE READER SERVICE NO. 553



### ▶ PC MEGASTORE HARD-DISK SYSTEMS

Ampex has introduced the PC Megastore system, a self-contained 10- or 20-megabyte Winchester hard disk.

A 25-megabyte tape backup is also available, either separately or in a unit subsystem with a 20-megabyte hard disk to provide a total of 45 megabytes of on-line storage. The tape has its own 64K buffered memory and is directly addressable so that you can use it as primary storage, as well as for accessing and updating



### ▶ ENSEMBLE FOR THE MAC

A fully integrated software package designed specifically for the Macintosh, Ensemble is an easy-to-use productivity tool for business applications. Users can coordinate such tasks as word processing, informa-

Maccessories A-B Box lets you use three peripherals with the Mac.



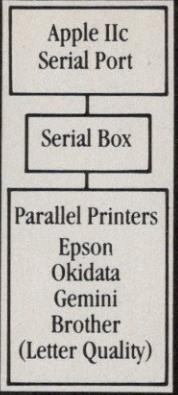

**The game for the Macintosh™**

Feathers & Space is a Macintosh™ arcade game that takes full advantage of the graphics and sounds of the Mac. Attacking birds stress the defense capabilities of your mother ship and the space outpost. Protect the space outpost or get eaten alive. Mouse ship movements, click activated firing power and keyboard smart bombs. This game also offers defense from discovery; one mouse movement and your boss can't walk in and smart bomb you if you're defending your outpost at work.

**Feathers & Space for Macintosh \$34.95**

# ★ *Feathers & Space*

**Add a parallel printer to your IIc**

Here's a low cost serial to parallel adapter that comes complete with everything you need to connect your Apple's serial printer port to a standard parallel printer. This unit also allows you to print Epson Graphics. Please specify printer type. A Serial Box for the Macintosh™ will soon be available. Call for details.

**Serial Box for the IIc \$89.95**

# ★ *Serial Box*

**Personalize Your Macintosh™ icons!**

Set your icons apart! The icon switcher allows anyone to quickly and easily customize their icons for a more personal, identifiable desktop.

**Simple to use:**

1. Take any MacPaint™ picture, place it into the Scrapbook and switch it to the icon of your choice.
2. You can also switch an existing icon from one file to another.

If you don't have the time to create your own icons, see about our Icon Libraries; we have both Business and Fun & Games sets available.

**Icon Switcher for Macintosh \$19.99**

# ★ *Icon Switcher*

CIRCLE 140 ON READER SERVICE CARD

Apple IIc, IIe, AppleWorks and MacPaint are trademarks of Apple Computer, Inc. GraphWorks and Feathers & Space are trademarks of PBI Software. Macintosh is a trademark licensed to Apple Computer, Inc.

**Business Icons**

Ready to use! Business icons such as office equipment, paper sheets, books, large block letters and numbers, custom folders and many shapes to help you design your own icons. Over 100 to choose from.

**Fun & Games Icons**

Creative, non-traditional icons for your desktop. For example, a wine glass, garbage can, joker, a lovely lady, an airplane and more! Choose from over a 100 fun icons.

**Icon Libraries for Macintosh \$19.99 each**

# ★ *Icon Libraries*

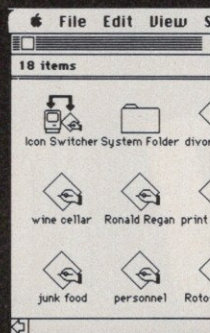
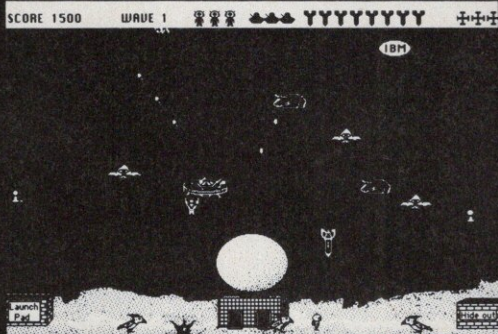

for the **IIe/IIc**™

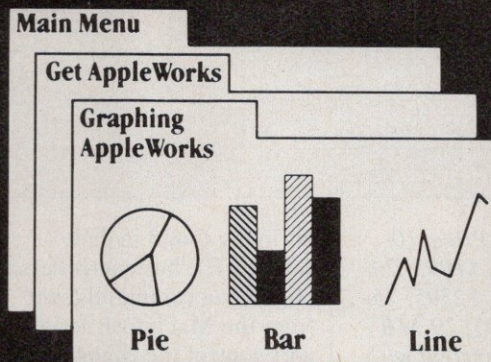

**GraphWorks adds graphics to AppleWorks™**

Visualize data. Print it. Present it. Now you can plot spreadsheet data files as line, bar, stack-bar or pie charts. The program is menu-driven and folder-oriented, so it's as easy to use as AppleWorks!

GraphWorks for the IIe/IIc

\$79.95

★ *GraphWorks*

# Five stars for your Apple.

Introducing a selection of new product stars for your Apple Computer from PBI Software.

Add a star and watch your Apple shine!

CIRCLE 143 ON READER SERVICE CARD

## To Order:

Call Toll Free: 800-843-5722

In California: 800-572-2746

VISA, MasterCard and American Express accepted.

Monday thru Friday 9AM-5PM PST

Information & Dealer inquiries, call: 415-349-8765

**PBI Software**  
A SUBSIDIARY OF ITAT, INC.

1155B-H Chess Drive • Foster City, CA 94404

for the **Macintosh**™

archives. (List Price: 10-MB hard disk, \$1995; 20-MB hard disk, \$2395; 25-MB tape, \$1995; 20-MB hard-disk subsystem with 25-MB tape, \$4295)

**Requires:** Apple II Plus or IIe

Ampex Corporation  
10435 North Tantau  
Avenue  
Cupertino, CA 95014  
(800) 421-6863  
in CA (213) 640-0150

CIRCLE READER SERVICE NO. 554

## ► HARDWARE

MAC

### ► MACCESSORIES A-B BOX

The Maccessories A-B Box lets you use three peripherals with the Macintosh by connecting two peripherals to one serial port on the computer. To do so, you plug the A-B Box into one serial port and then plug two peripherals into the box. You can then divert data output to the peripheral of your choice. The box also enables two computers to share one peripheral—you plug both computers into the A-B Box along with the single peripheral. (List Price: \$99.95)

**Requires:** Macintosh  
Kensington Microwave Ltd.  
251 Park Avenue South  
New York, NY 10010  
(212) 475-5200

CIRCLE READER SERVICE NO. 555

MAC

### ► MAC488A BUS CONTROLLER

The Mac488A Bus Controller takes advantage of the high-speed serial abilities of the Macintosh to communicate at speeds of up to 57,600 bps. The interface includes all features

normally found in dedicated IEEE bus controllers. High-level commands sent from the Macintosh serial port control the Mac488A, which contains a microprocessor that interprets the commands. The controller is compatible with all languages that can access the computer's serial port.

Mac488A comes with power supply, manual, and a 12-foot cable. (List price: \$595)

**Requires:** Macintosh

IOtech, Inc.  
P.O. Box 21204  
Cleveland, OH 44121  
(216) 831-8646

CIRCLE READER SERVICE NO. 556

II SERIES

### ► FORTIS DM20 DOT-MATRIX PRINTER

The Fortis DM20 dot-matrix printer, which produces high-quality graphics and letter-quality correspondence and can accommodate spreadsheets of up to 220 columns, is available from Dynax. The DM20 has rear-mounted switches that enable you to install it for either parallel or serial interfaces. It offers a choice of 10, 12, or 16.7 characters per inch or proportional print spacing in either word- or data-processing modes.

The DM20's high-resolution mode produces the equivalent of 17 × 16 dots per character, using a 0.30 mm 9-wire printhead. In pica draft mode, it operates at 160 characters per second (cps) and in letter-quality mode at 30 cps. (List Price: \$888)

**Requires:** Apple II or III  
Dynax, Inc.  
6070 Rickenbacker Road  
Commerce, CA 90040  
(213) 727-1227

CIRCLE READER SERVICE NO. 557

The Mac488A bus controller for the Macintosh, from IOtech, takes advantage of the Mac's high-speed serial abilities to communicate at speeds of up to 57,600 bpm.

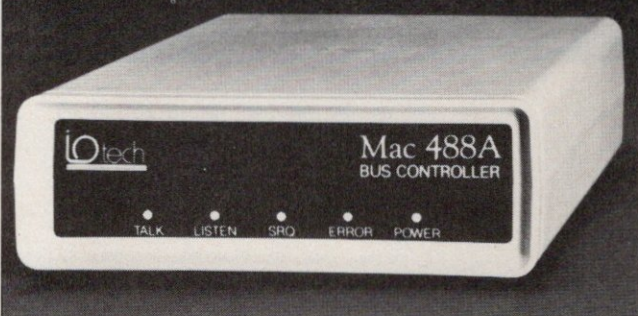

II SERIES

### ► QC20 MASS-STORAGE SYSTEM

A 20-megabyte mass-storage system, the QC20 hard disk, is now available from Quark Peripherals. Users can segment the hard disk into separate volumes, each password-protected to limit or prevent access to its data. On the Macintosh, the QC20 plugs directly into the computer's floppy-disk port, leaving other ports free so that users can connect both a printer and a modem at the same time. (List Price: \$2595)

**Requires:** Apple IIc, IIe, III, or Macintosh  
Quark, Inc.  
2525 West Evans  
Suite 220  
Denver, CO 80219  
(303) 934-2211

CIRCLE READER SERVICE NO. 599

II SERIES

### ► C-PRINT PRINTER INTERFACE

The MW-100 C-Print parallel printer interface has a standard 36-pin connector that plugs into a printer and a 5-pin DIN connector that plugs into the Apple IIc's serial port. To use the interface, you need only plug it in—no special text software or configuration of the serial port is necessary. Data is output to the printer at 9600 baud with standard DTR handshaking, so no information is lost. (List Price: \$99)

**Requires:** Apple IIc  
Micro R&D, Inc.  
3333 S. Wadsworth Blvd.  
Suite A-104  
Lakewood, CO 80227  
(303) 985-1473  
(303) 985-4077

CIRCLE READER SERVICE NO. 598

The Fortis DM20 dot-matrix printer has a 15½-inch-wide carriage.

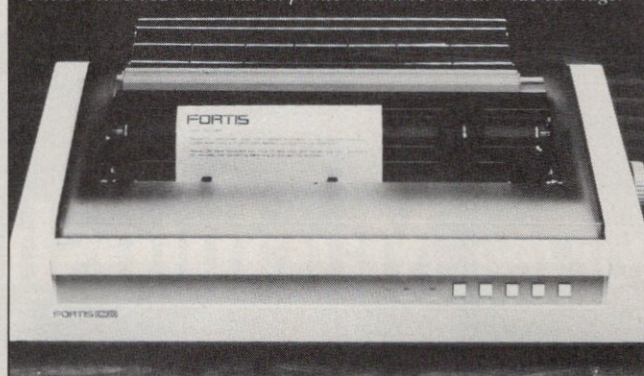



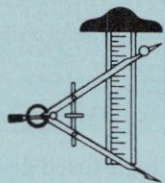

# Introducing **idd**'s **MacDraft™**

The Ultimate Drawing Package for the Macintosh™

MacDraft™ is the most powerful object oriented drawing tool available for the Macintosh™ today. Its ease of use, combined with its powerful capabilities, allows even the most casual user to produce professional looking drawings. The versatility of MacDraft™ makes it ideal for the beginner, as well as the professional.

Although MacDraft™ is powerful enough to create scaled drawings, schematic diagrams, organizational charts and business illustrations, it is also ideally suited for creating general sketches, greeting cards, and almost any other picture that you might want to draw.

## Features

- Continuous drawing mode.
- 16 Different scales.
- Zoom In and Zoom Out.
- Automatic dimension lines.
- Circles by radius or diameter.
- Arcs by radius or 3-points.
- Distribute objects along a line.
- Rotate objects in 1 degree increments.
- Create objects by inside or outside diameter.
- 4 Separate documents on the screen at the same time.
- Paste illustrations to and from other documents.
- Paste pictures from MacPaint™.
- 64 Patterns for Fill & Ink.
- Flip objects.

MacDraft™ offers 16 different scales to suit your needs.

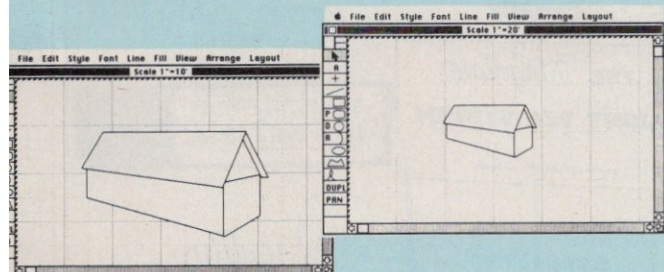

Objects created at one scale, can be pasted into a drawing at a different scale. The objects will reduce or enlarge to conform to the new scale. You may also change the scale of the entire drawing.

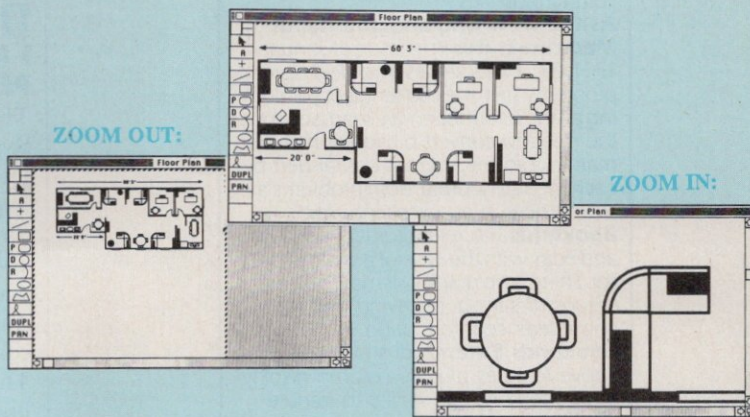

The Zoom functions allow you to see either a reduced or enlarged view of the drawing. Regardless of the view, you still have full access to all of the drawing capabilities of MacDraft™.

**ZOOM OUT:** to see your entire drawing, and also add large objects that may stretch beyond a normal view.

**ZOOM IN:** to add fine details to your drawing that may not be convenient to create at a normal view.

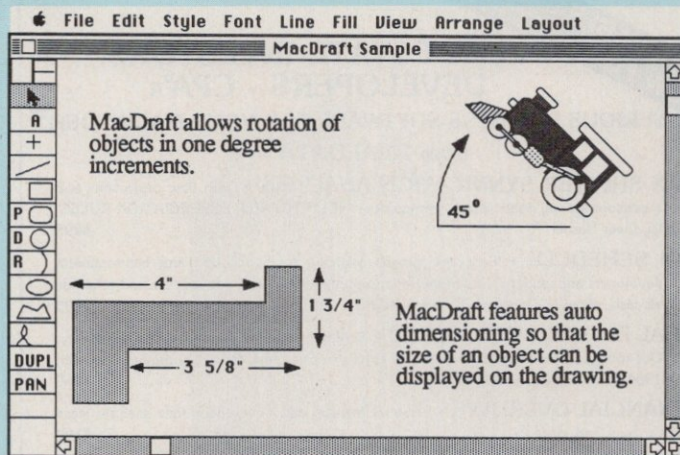

Draw your own conclusions, with MacDraft™. For more information, see your dealer or call us today.

**idd** inc.

**Innovative Data Design, Inc.**

1975 Willow Pass Road, Suite 8, Concord, California 94520 (415) 680-6818

MacDraft is a trademark of Innovative Data Design, Inc. Macintosh and MacPaint are trademarks licensed to Apple Computer, Inc.

CIRCLE 112 ON READER SERVICE CARD

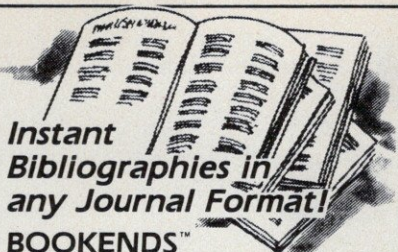

## Instant Bibliographies in any Journal Format!

### BOOKENDS™

allows you to quickly put your finger on any journal, any paper, any book, any specific information contained in your voluminous files.

**As the New England Journal of Medicine states** in its issue of January 12, 1984, it "addresses two widespread problems: first, the challenge of cataloging all the information we read; second... the need to convert bibliographic information into the...format demanded by each medical journal. Both problems are solved here in an excellent way."

**Bookends** has extraordinary versatility and edits with the ease of a word processor. There is no quicker or more efficient means of saving, retrieving and formatting reference information.

**Bookends Extended** is available with above features plus 80-column display, more memory, and ability to handle unlimited references.

**BOOKENDS™**, the reference management software system is available for Apple computers for \$124.95. Bookends Extended \$149.95.

Apple is a trademark of Apple Computer, Inc.



**Sensible Software, Inc.®**

210 S. Woodward, Suite 229,  
Birmingham, MI 48011 (313) 258-5566

CIRCLE 103 ON READER SERVICE CARD

AVAILABLE  
NOW FOR JAZZ™

## REAL ESTATE INVESTORS DEVELOPERS - CPA's

SERIOUS BUSINESS SOFTWARE FOR YOUR MACINTOSH™  
from REALDATA

**TAX SHELTER SYNDICATION ANALYSIS** - Cash flow projections and allocations for real estate limited partnerships. INCLUDES NEW DEPRECIATION RULES.  
By Irwin Nestler **\$295**

**ON SCHEDULE** - Economic project planning for subdivision and condominium developers and lenders. This month-by-month timetable helps you analyze and schedule all cash inflow and outflow. By Irwin Nestler **\$195**

**REAL ESTATE OVERLAYS '84** - Sophisticated analysis of investment property. Our most popular program includes an extensive cash flow/sensitivity model, now with 1984 TAX REFORM ACT RULES. **\$150**

**FINANCIAL OVERLAYS** - Personal financial statement, critical ratio analysis, lease vs. buy, and more. **\$100**

**COMMERCIAL/INDUSTRIAL APPLICATIONS** - Detailed project cost analysis, multi-unit-income-and-expense schedule, and lease-tracking model. **\$100**

**RESIDENTIAL MODELS** - Market analysis by linear regression, mortgage qualifier, and rent vs. buy analysis. **\$100**

Minimum shipping charge \$5 - CT residents add 7.5% sales tax

READY TO RUN - EASY TO USE

Requires Multiplan™ or Jazz™

**REALDATA**

Software for Real Estate and Financial Professionals  
78 North Main St., South Norwalk, CT 06854

TO ORDER, CALL OR WRITE TODAY **203-255-2732**

MC/VISA/COD Accepted

Multiplan is a trademark of Microsoft Corp. Jazz is a trademark of Lotus Development Corp.

CIRCLE 342 ON READER SERVICE CARD

A+ pipeline

## ► HARDWARE/ SOFTWARE



### ► MAGELLAN LIGHT PEN SYSTEM II

The Magellan Light Pen System II has a high-resolution light pen with a built-in pushbutton that interacts directly with a monitor or TV screen. The pen allows you to create drawings with single-dot accuracy on the computer's graphic display. The system also includes a high-performance interface card that plugs into any expansion slot. The card includes 4K ROM containing light-pen and high-speed graphics routines.

The system comes with Quick-Draw and Amber-Pen software packages. The Quick-Draw program enables you to create and edit commercial-quality graphics designs. Its features include freehand drawing, color/pattern fill, a pattern editor, a Zoom mode, window operations, symbol tables, high-resolution text,

high-speed disk commands, and more. (List Price: \$189.95)

**Requires:** Apple II, II Plus, or IIe

Magellan Computer, Inc.  
4371 East 82nd Street  
Suite D

Indianapolis, IN 46250  
(317) 842-9138

CIRCLE READER SERVICE NO. 5



### ► SYNTAURI COMPUTER MUSIC SYSTEM

Market Interface has acquired the exclusive license to manufacture and market the Syntauri Computer Music System, which has not been manufactured since September 1984. The company will produce both software and hardware products for educators, reformers, and composer. Software currently available includes Simply Music and alphaPlus, which was developed by Syntauri Corporation, and Versatrac developed by Market Interface.

The Syntauri Simp

The Magellan Light Pen System II includes a light pen, interface card, software, and complete documentation.





**Apple and Macintosh Owners...  
Triple the Usefulness of Your Software with  
COMMAND-EZE GUIDES. Just \$12.95!**

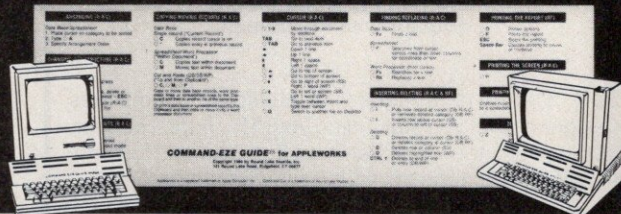

Now, eliminate the need to constantly look up software commands. Plus discover all those "special" commands buried in the manuals. **COMMAND-EZE™ GUIDES** save time—and increase the value of software. Get the guides used by businesses, schools, professionals!

- Puts all the software commands at your fingertips
- Rests above keyboard for perfect viewing
- Primary commands on front, special-purpose commands on back
- Organized alphabetically for instant use
- Uncluttered design enhances readability
- Compare—the easiest guides to understand
- Stores easily, only 4" x 13"
- Highest quality non-glare laminated vinyl

**Order Today!  
No Risk  
15-day  
Money Back  
Guarantee!**

**For the Apple**

- APPLEWORKS IIe/IIc
- APPLE WRITER II
- QUICK FILE IIe
- APPLE WRITER IIe/IIc
- VISICALC

**For the Macintosh**

- MULTIPLAN
- WORD

To order, send your name, address, check or money order for \$12.95 for each **COMMAND-EZE GUIDE**, plus \$1.95 shipping per order. Or charge to your VISA/MC by sending complete card number and expiration date.



**Round Lake Studios, Inc. Dept. ST7**  
131 Round Lake Road, Ridgefield, CT 06877  
(203) 431-9696

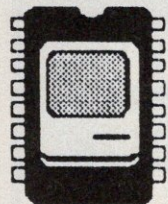

**512K!**

MacMemory Electronics is pleased to announce an easy-to-install 512K upgrade kit for Macintosh. Our kits are the "Electronic Twin™" of the factory 512K machine. Compatibility is guaranteed.

The MacMemory Upgrade is also available fully assembled and tested with a 90-day warranty.

Why pay more for the same thing?

Order your MacMemory Upgrade today!

- \$249.00 MacMemory Upgrade Installed**
- \$175.00 MacMemory Upgrade Kit**
- \$ 9.50 Case Removal Tool**

Installed Orders: Send \$12.50 for case removal tool, instructions, and shipping container for your old 128K board. We ship an assembled 512K board via UPS Air the same day we receive your 128K board and payment for the upgrade.

Kit Orders: Add \$4.50 Shipping. Removal tool required to open case.

Payment is by VISA, MASTERCARD, check, or C.O.D.  
CA Residents add 6% Sales Tax.

**MacMemory Electronics**

500 W. Middlefield Rd., Suite 28  
Mountain View, CA 94043 (415) 964-4176



CIRCLE 132 ON READER SERVICE CARD



driver software, and other software such as a built-in word processor. Other features include a transparent electronic ruler; a scissor pointer that lets you clip columns of text into fragments or carryovers; separate Format, Layout, and Print menus; and dummy pages with miniatures of page-makeup layouts. (List Price: \$6495)

Infotek, Inc.  
56 Camille  
E. Patchogue, NY 11772  
(516) 289-9682

CIRCLE READER SERVICE NO. 562

**SOFTWARE**



**WHERE IS CARMEN SANDIEGO?**

The second release in Brøderbund's Explorations series of educational games, Where in the World is Carmen Sandiego? enables players to sharpen their mystery-solving skills while they learn about world ge-

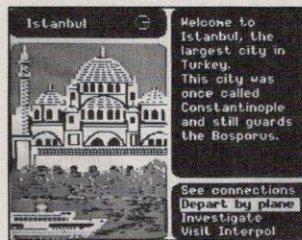

A sample screen from *Where in the World is Carmen Sandiego?*, an educational game from Brøderbund Software

ography. The game comes with a copy of the 1985 *World Almanac and Book of Facts* to help players find clues as to the whereabouts of international thieves such as Sandiego. Every game is different—the mystery scenarios involve 10 different villains and 30 countries. (List Price: \$39.95)

**Requires:** Apple II Plus, IIe,

or IIc; 64K RAM; one disk drive

Brøderbund Software  
17 Paul Drive  
San Rafael, CA  
94903-2101  
(415) 479-1170

CIRCLE READER SERVICE NO. 563



**DATAPAK MAC SOFTWARE**

DataPak Software has released two new software products—Mac-Poker, a gambling game, and the Printer Interface—for the Macintosh.

Mac-Poker is a five-card-draw game that you can play against the Macintosh, using the mouse. Play starts with the ante being placed in the pot and the "dealer" dealing five cards. You bet or pass, the dealer sees your bet or passes, and you then discard unwanted cards and draw up to five new ones. You bet or pass again, and the dealer matches, passes, or folds.

As well as clear graphics, the game has humorous editorial comments from the dealer regarding your skills.

Printer Interface allows you to interface the Macintosh with virtually any serial-interface letter-quality printer and several dot-matrix printers. The software works with all programs available for the Mac and can add features, such as boldface or underlining, if your program or printer does not have them. (List Price: Mac-Poker, \$39.95; Printer Interface, \$59.95) **Requires:** Macintosh DataPak Software, Inc. 14011 Ventura Blvd. Suite 401 Sherman Oaks, CA 91403 (818) 905-6419

CIRCLE READER SERVICE NO. 564



## ► ASCII EXPRESS PRO-DOS

A new updated telecommunications package designed to work with Apple IIe or IIc computers running under ProDOS is now available. ASCII Express Pro-DOS is compatible with all popular modems and direct-connect applications and allows users to dial up any public-information databases or to communicate with other computers. The program includes on-line help menus, support for baud rates up to 9600, error-free file-transfer protocols, macros, unattended operation, a data buffer, and an easy-to-use Install program that lets you customize the package.

(List Price: \$129.95)  
**Requires:** Apple IIe or IIc  
 United Software Industries, Inc.  
 1880 Century Park East  
 Suite 311  
 Los Angeles, CA 90067  
 (213) 556-2211  
 CIRCLE READER SERVICE NO. 565



## ► KRELL SOFTWARE PROGRAMS

Two new programs are now available from Krell Software. Reading Assessment Program: Individual Diagnostic enables you to evaluate and analyze children's reading skills. The program not only identifies the student's specific reading problem areas but also provides reading practice,

helps build vocabulary, and prepares students for state-mandated tests. Other features include a choice of difficulty levels and the ability to generate hard copy and disk records.

Study Money incorporates a large database of financial-aid sources that students can use to assist them in their search for aid. Students provide information about their career goals, personal background, academic training, and so on, and the program uses this information to identify those awards for which the student is qualified. The program then offers guidance in writing to the appropriate award sources. (List Price: Reading Assessment Program,

\$199.95; Study Money, \$49.95)

**Requires:** Apple II, II Plus, or IIe  
 Krell Software Corporation  
 1320 Stony Brook Road  
 Stony Brook, NY 11790  
 (516) 751-5139  
 CIRCLE READER SERVICE NO. 521



## ► GRAPHWORKS ProDOS PROGRAM

Offering business-graphics capabilities to users of AppleWorks, GraphWorks is a stand-alone ProDOS program that directly utilizes AppleWorks' spreadsheet data files and plots them as four graph types—bar, stacked bar, line, and pie. The program is menu-driven and folder-oriented.

# RENT SOFTWARE

Over 1400 titles for the Apple family of computers . . .  
 Now featuring Macintosh software!

If you can't afford to waste money on software that is seldom used, you should consider our unique rental program. All too often, software fails to perform as anticipated or advertised. Or it quickly becomes boring. Unfortunately, this discovery is made **after** it's too late. Because unlike an ill-fitting garment, you cannot return or exchange ill-fitting software.

Renting software before you make a commitment to buy it, helps you choose the right software for your applications. You can rent software for 3 weeks at a **fraction** of the retail price. All rental fees are applied to our ultra-low prices...if you decide to buy! And our expanding, diversified collection of over 1400 titles provides you with the widest range of software available for the Apple.

There are of course, many applications where renting software is simply more practical than buying it. 3 weeks may be all the time you'll **need** with many of our entertainment and educational selections. If you belong to a video club or library, you already know about the advantages this arrangement provides.

Renting software is not the only way we can save you money. Chances are, you already have some dust-collectors on your shelves. Selling or swapping is a good way to recover some of the money that's tied up in little used software. But you'll need our catalog for more information on these flexible options.

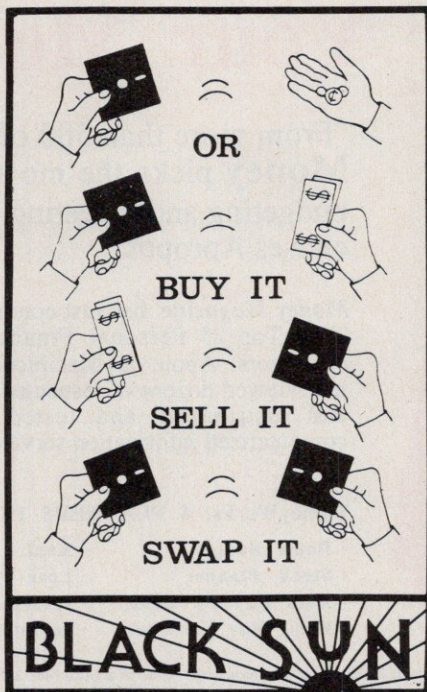

### RENTAL CATEGORIES

Adventure/Fantasy • Business Communications • Education • Games Home/Hobby/Utility • Strategy Word Processing • Hardware • Books plus hundreds of Rare & ½ price items!

### INTRODUCTORY OFFER

Join now and save \$5.00 off the normal \$25.00 membership fee. There are no annual dues, upkeep fees, or hidden costs. Send check or Visa/MC info for \$20.00 along with your name, address & phone #. Please specify type of computer and memory (II, II+, //e, //c, etc.). We will rush you our latest catalog, forms, and membership #. If you are not completely satisfied with our service and/or selections (try us out at no risk!), let us know within 30 days and we will refund your membership fee!

For more information

**Call**  
**(215) 967-3300**

or write  
**Black Sun**  
 411-A State Road  
 Emmaus, PA 18049

Apple is a registered trademark of Apple Computer, Inc.  
 Macintosh is a registered trademark of Apple Computer, Inc.

Other features include a title editor, a pop-up Option window, and a choice of two sizes of printouts. (List Price: \$79.95)

**Requires:** Apple IIe or IIc, one disk drive, AppleWorks, optional printer  
PBI Software  
1155B-H Chess Drive  
Foster City, CA 94404  
(800) 843-5722  
in CA (800) 572-2746  
CIRCLE READER SERVICE NO. 547



► **FONT SETS FOR THE MAC**

Two new font collections for the Mac are available from 21st Century Software.

The UltraFonts Technical & Business Set features a font that includes more

than 100 commonly used medical, legal, mathematical, and engineering symbols that come in every standard Macintosh size, from 9 to 36 point. The set also contains two Greek fonts—serif and sans serif—and a mathematics font that enables users to create complex formulas in MacWrite.

The second product, UltraFonts Extended Character Set, includes 21 fonts, ranging from 6 to 36 points in size, that are equipped with all the special accents users need to type in languages such as Czech, Polish, Hungarian, Esperanto, and many more. The collection also includes a 6-point font for small lettering, a correspondence-quality

font for letters and reports, a borders font that allows users to type in boxes and borders, and a symbols font that includes many of the standard icons that the Macintosh uses. (List Price: \$29.95 each; \$49.95 together)

**Requires:** Macintosh  
21st Century Software  
Malon Products, Inc.  
2306 Cotner Avenue  
Los Angeles, CA 90064  
(213) 829-4436  
CIRCLE READER SERVICE NO. 566



► **MACLINE NETWORKING**

The third product in TouchStone Software's The Connectables series, MacLine is a networking software

package for the Macintosh. Using the MacLine terminal emulator, users can connect their Macintosh computers to a variety of other computers and information services. When you use MacLine in conjunction with the other Connectables products—PCworks and UniHost—the Macintosh can transfer all types of files to and from UNIX systems or IBM PCs, exchange mail with other system users, and access a remote printer or disk. (List Price: \$145)

**Requires:** Macintosh  
TouchStone Software Corporation  
909 Electric Avenue  
Suite 207  
Seal Beach, CA 90704  
(213) 598-7746  
CIRCLE READER SERVICE NO. 567

Introducing MoneyWorks for Your Apple II

# Now Your AppleWorks® for Your Money!

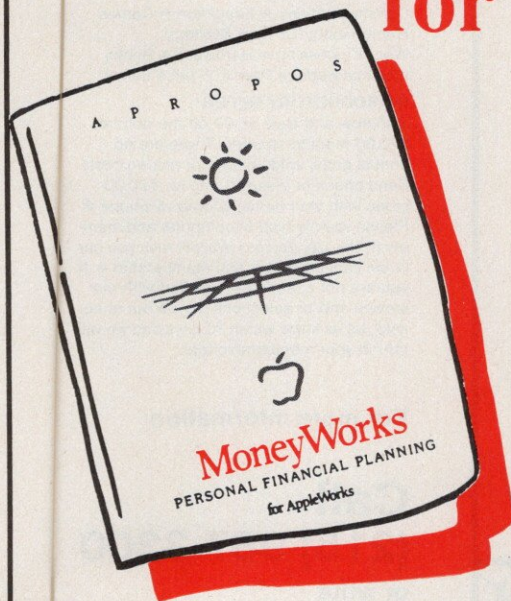

"From more than 500 offerings on the market **Money** picks the most useful software for budgeting and investing." **Money Magazine** chooses Apropos!

*Money Magazine* has just conducted an extensive search for "The Top 25 Personal Finance Programs" for personal computers. About our Macintosh version, *Money* wrote, "we interviewed dozens of respected financial software reviewers and distributors and tested scores of products and computerized information services....Apropos has succeeded!"

**MoneyWorks: 8 PLANNERS IN 1 PACKAGE \$95.**

- Home Budget
- Stock Planner
- Auto Buy Vs. Lease
- Home Buy Vs. Rent
- Real Estate
- Loan Planner
- Insurance Planner
- Investing for College

Sug. Retail Price

This product requires AppleWorks® and is available now. Contact your local dealer or call us at (415) 948-7227. Mail orders should include \$3.00 for shipping and handling. California residents include 7% sales tax. Money Magazine quotes were taken from the November, 1984 issue referencing our Macintosh version of MoneyWorks called The Financial Planning Series.

APROPOS SOFTWARE • 64 HILLVIEW AVE • LOS ALTOS, CALIFORNIA. 94022

CIRCLE 200 ON READER SERVICE CARD

MAC

### ► MASTERFORTH

An implementation of the Forth programming language for the Macintosh, MasterForth includes a 68000 macro-assembler and support for the mouse, the Finder, menus, and the graphics toolbox. Standard features include a string package and resident debugger, and relocatable utilities and transient definitions enable users to run substantial software packages. MasterForth exactly matches the Forth-83 standard dialect described in *Mastering Forth* (Brady, 1984), which is also included in the package. (List Price: \$125)

**Requires:** Macintosh  
MicroMotion

12077 Wilshire Blvd. Suite 506  
Los Angeles, CA 90025  
(213) 821-4340

CIRCLE READER SERVICE NO. 568

MAC

### ► HEARTS CARD GAME

A card game designed for the Macintosh, Hearts offers realistic card and playing-table graphics; automatic shuffling, dealing, and point tabulation; variations of your opponent's skill level, passing, and first-trick discards; and more. The program makes use of the computer's mouse, and pull-down menus provide a tutorial and rules for play. (List Price: \$29.95)

**Requires:** Macintosh  
Artsci, Inc.

5547 Satsuma Avenue  
North Hollywood, CA 91601  
(818) 985-5763

CIRCLE READER SERVICE NO. 518

II  
SERIES

### ► NEW PIXELWERKS SOFTWARE

A new program is available in Mindscape's Pixelwerks line of educational software, which is designed to teach children eight years and older to use computers as creative tools and to develop programming skills. The program forms part of a series of six programs that can be used in conjunction with one another.

The new program, Mr. Pixel's Cartoon Kit, lets children select or build colorful cartoon characters and then

# Brainy Buffer.

Do you press print and wait?  
And wait?  
And wait?

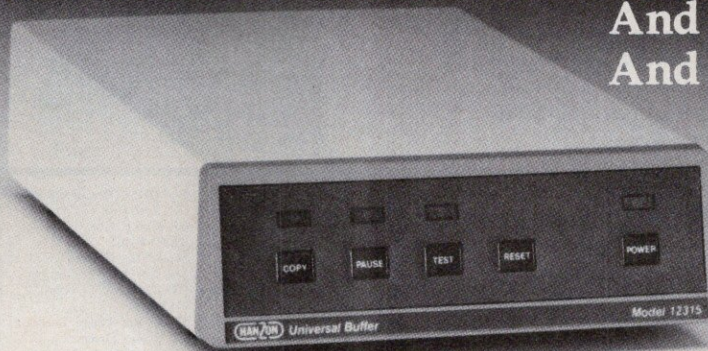

Your waiting is over with the Universal Data Buffer—it frees your computer in seconds while it handles the printing of your file.

And the Universal Data Buffer from HanZon is smarter than the average buffer. For one thing it has two inputs — one serial and one parallel, and two outputs— one serial and one parallel. Since all the ports are active, it means the Universal Data Buffer can interface between serial and parallel devices—even at different speeds and protocols. All that is a bonus to its standard function—as a 64K buffer expandable to 256K. The buffer also has operator controls for selecting additional copies, and pausing.

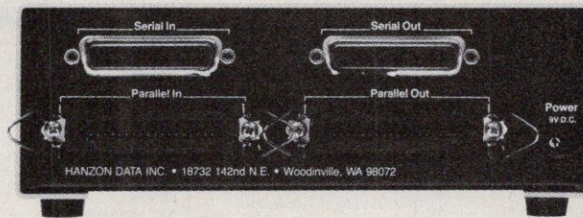

In this HanZon application we are interfacing an IBM-PC and an Apple IIc to an

Epson printer. The Universal Data Buffer automatically handles the serial-to-parallel interfacing and also manages a first-in, first-out file priority for the two computers. A

file that comes into the buffer from the IIc will begin printing immediately, but a file that subsequently comes in from the IBM will be stored until the first file is finished.

Call HanZon today for your nearest dealer:  
206-487-1717.

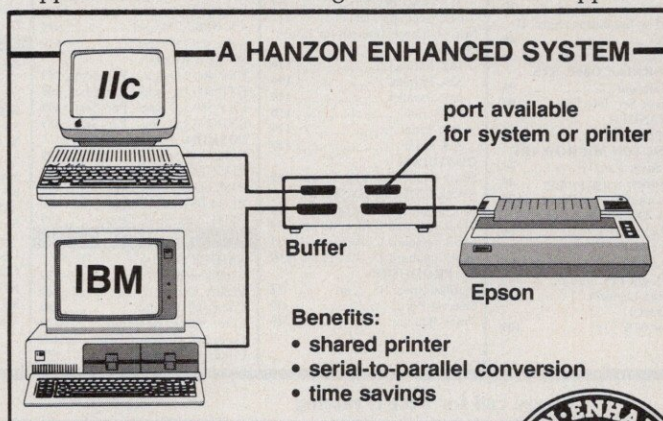

Suggested Retail Price: \$385—64K Buffer  
\$59—64K Expansion module

HANZON DATA INC. • 18732 142nd Ave NE • Woodinville, WA 98072

IBM is a registered trademark of IBM Corporation. Apple is a registered trademark of Apple Computer, Inc. Epson is a registered trademark of Epson America Corporation.

CIRCLE 216 ON READER SERVICE CARD

# A computer store's service at mail-order prices.

Because we're both.

Our commitment to service is why so many private individuals, schools and Fortune 1000 companies choose Micro City. If in the Chicago area, please visit us at 24W500 Maple Ave., Naperville.



## HARDWARE FOR APPLE

### DISK DRIVES FOR APPLE

Super 5 Direct Slim Drive	
II+, //e.....	\$169
Super 5 Dir. Slim Drive //c.....	175
PACE AP-50 Full Height. II+, //c.....	159
PACE AP-50 Full Hgt. //c.....	165
Remington Rand Floppy Drive. Mac.....	299
<b>GENERIC HARDWARE</b>	
16K Ram. II+.....	42
Z-80 Card. II+, //c.....	42
Cooling Fan. 2 outlets, Surge Protect. II+, //c.....	35
Joystick, fire button, (Spec. II+ //c).....	29
Computer Case. II+.....	59
Replacement Keyboard. II+.....	69
Case w/ built-in Numeric Keypad.....	119
RF Modulator.....	19
Power Strip, Surge Protect. 6 Outlets.....	19
<b>ADVANCED LOGIC SYSTEMS</b>	
CPM Card. II+, //c.....	269
Business Card T-Maker. w/ II+, //c.....	299
Z Engine II+, //c.....	139
Smarterm II. II+, //c.....	129
Dispatcher II+, //c.....	109
Printer Mate. II+, //c.....	69
<b>ALPENLITE</b>	
Mac Pro Carrying Case.....	59
//c Pro Carrying Case.....	59
<b>APPLIED ENGINEERING</b>	
.....	CALL
<b>CH PRODUCTS</b>	
Mach II Joystick (Spec. II+, //c, //e).....	38
Mach III w/ fire button (Spec. II+, //c, //e).....	45
Paddlestick Spec. II+, //c, //e.....	38
<b>CALIFORNIA COMP. SYS.</b>	
Clock Calendar.....	95
7711 Async Ser. Interface.....	99
<b>DISCWASHER</b>	
Printer Port Adaptor, //c.....	99
<b>KENSINGTON MICROWARE</b>	
System Saver Fan. II+, //c.....	65
Accessories: Surge protect.....	45
Accessories: Starter Pack.....	79
<b>KOALA TECHNOLOGIES</b>	
Koala Pad w/ SFT, //c, //e.....	69
Muppet Learning Keys w/ SFT, //c, //e.....	55
Gibson Light Pen.....	149
MacVision Digitizer.....	219
<b>MICO SCI</b>	
80 Col w/ 64K, //e.....	109

## MICROSOFT

SoftCard II.....	\$249
Premium SoftCard //e.....	269
<b>MICROTEK</b>	
Dumpling-GX.....	79
Dumpling Interface w/ 16K.....	159
64K Ram Card. II+, //e.....	159
128K Ram Card II+, //e.....	219
Magnum 80me 80 Col w/ 64K, //e.....	119
<b>MITSUBA</b>	
80 Col w/ 64K, //e.....	99
<b>MOUSE SYSTEMS</b>	
A+ Mouse, //c, Mac.....	89
<b>ORANGE MICRO</b>	
Grapppler +, II+, //c.....	89
Buffered Grapppler +, II+, //c.....	159
Bufferboard II+, //e (Spec. your Interface).....	89
Serial Grapppler +, II+, //c.....	99
Orange Interface. II+, //c.....	59
<b>PERSONAL COMP. PROD.</b>	
Appli-Card 6 MHz/64K memory II+, //e.....	249
Appli-Card 6 MHz/64K RAM Extender II+, //e.....	359
<b>PRACTICAL PERIPHERALS</b>	
GraphiCard (Graphics int.).....	79
SenALL (RS 232).....	109
Switchport for //c.....	89
Pro Clock.....	109
<b>Microbuffer II, spec. printer</b>	
16K spec. par/ser.....	109
32K spec. par/ser.....	119
Microbuffer II+ (both par & ser) 16K.....	139
32K.....	149
64K.....	169
<b>Microbuffer In-Line External</b>	
32K (spec. par/ser).....	189
64K (spec. par/ser).....	219
<b>Microbuffer/E Internal for Epson Printers</b>	
16K Parallel.....	119
32K Parallel.....	139
64K Parallel.....	179
8K Serial.....	119
16K Serial.....	129
32K Serial.....	149
<b>QUADRAM</b>	
eRam 80 (80 Col. 64K, //e).....	109
<b>SWEET MICRO SYSTEMS</b>	
Mockingboard A (Music).....	89
Mockingboard B (Speech).....	79
Mockingboard C (A+B).....	139
Mockingboard D, //c.....	159
<b>TG PRODUCTS</b>	
Paddles (spec. II+, //e).....	32
Select-a-Port.....	39
Track Ball.....	49

## TITAN SYSTEMS

64K Ram Card.....	\$159
128K Ram Card.....	199
64K + 80 Col, //c.....	199
128K + 80 Col, //c.....	289
192K + 80 Col, //c.....	349
Accelerator //e, II+, //c.....	229
<b>TRACK HOUSE</b>	
Programmable 10-Key Numeric Keypad for //c.....	139
<b>VIDEX</b>	
Ultraterm (132 Col).....	249
Videoterm VT600 (80 Col).....	189
VT601 (80 Col + SS).....	209
VT602 (80 Col SS + Inv).....	219
Lower Case Chip.....	25
Visicalc Preboot.....	45
Apple Writer II Preboot.....	22
Ult. Visicalc Preboot.....	54
Ult. Appewriter Preboot.....	24
<b>PRINTERS</b>	
<b>ABATI</b>	
LQ Parallel.....	329
<b>BROTHER</b>	
HR-15XL, LQ spec. par/ser.....	369
HR-35P, Letter Quality.....	759
<b>COMREX (Div. of Epson)</b>	
CR-11e, LQ parallel.....	369
CR-11e LQ serial.....	379
Keyboard.....	169
Tractor.....	99
<b>EPSON</b> .....CALL	
<b>NEC SPINWRITER</b>	
NEC 3510, Serial.....	1199
NEC 3530, Parallel.....	1199
Bi-Dir. Tractor, 3500 Series.....	179
Cut Sheet Feed, 3500 Series.....	729
<b>OKIDATA</b> .....CALL	
<b>PANASONIC</b>	
KX-P1090, Parallel.....	219
KX-P1091, Parallel.....	299
KX-P1092, Parallel.....	389
KX-P1093 Par/ Ser.....	539
<b>SILVER REED</b>	
EXP-400 LQ (spec. Par/ Ser).....	259
EXP-500 LQ (spec. Par/ Ser).....	309
EXP-550 LQ (spec. Par/ Ser).....	409
EXP-770 LQ (spec. Par/ Ser).....	689
<b>TOSHIBA</b>	
P1340 LQ (spec. Par/ Ser).....	589
P1351 LQ (spec. Par/ Ser).....	1249
P351 LQ, Par.....	1269
P1351 Bi-Direct Tractor.....	159
P1351 Auto Sheet Feeder.....	699
<b>MONITORS</b>	
<b>AMDEK</b>	
V300 Green.....	139
V300A Amber.....	149
Color 300 (Comp).....	249
Color 500 (RGB Comp).....	329
Color 600 Hi/ Res RGB.....	419
Color 710 Super Hi. RGB.....	539

## COMREX (Div. of Epson)

CR-5650, Green or Amber.....	109
CR-6700 Hi/ Res RGB.....	399
<b>SAMSUNG</b>	
MD1251D, Hi/ Res, Green.....	115
MD1251D Hi/ Res, Amber.....	119
CD1451D Color Comp.....	229
<b>TAXAN</b>	
12" Hi/ Res Amber.....	139
12" Hi/ Res Green.....	129
210 Color (RGB/ Comp).....	259
410-08 RGB Int. II+, //c.....	79
410-8064 RGB Int. //c.....	189
<b>MODEMS</b>	
<b>HAYES</b>	
Smartmodem 300.....	159
Smartmodem 1200.....	389
Smartmodem 2400.....	619
Micromodem //c w/ SFT.....	159
Smartmodem 300 w/ SFT, //c.....	179
<b>KENSINGTON MICROWARE</b>	
Accessories: Portable Modem for Mac, //c.....	109
<b>NOVATION</b>	
Smart Cat Plus 300/1200 Baud w/ Software for Mac.....	299
J-CAT.....	89
Apple CAT II.....	189
212 Apple Cat Upgrade.....	219
212 Apple Cat System.....	349
Expansion Module.....	29.95
Touch Tone Receiver.....	79.95
Firmware ROM.....	25.95
<b>PROMETHEUS</b>	
Promodem 1200 Ext.....	309
Promodem 1200A w/ Software for II+, //c.....	309
Promodem 1200 w/ Mac Pac.....	399
Promodem 1200 w/ SFT, //c.....	359
<b>ZOOM TELEPHONICS</b>	
Zoom Modem //c Apple.....	139
<b>DISKETTES</b>	
<b>BASF</b>	
SS DD Box of 10.....	17.95
SS DD 3.5" Box of 5.....	17.95
<b>BONUS</b>	
SS DD Box of 10.....	17.95
<b>MAXELL</b>	
SS DD Box of 10.....	19.00
<b>VERBATIM</b>	
SS DD Box of 10.....	19.95
DS DD Box of 10.....	26.95
SS DD 3.5" Box of 10.....	34.95
Disk Drive Analyzer.....	29.95
Disk Drive Head Clean. Kit.....	8.95
Cleaning Diskettes - 10.....	12.00
<b>XIDEX</b>	
SS DD Box of 10.....	15.95
DS DD Box of 10.....	16.95
<b>SOFTWARE</b>	
.....	PLEASE CALL!



combine them into animated cartoon features. (List Price: \$34.95)  
**Requires:** Apple II, II Plus, or IIe; one disk drive; joystick  
 Mindscape, Inc.  
 3444 Dundee Road  
 Northbrook, IL 60062  
 (312) 480-7667

CIRCLE READER SERVICE NO. 571



## GRAPHICS COLOR PACKET

Using a Macintosh, a black-and-white printer, and the Computer Graphics Color Packet, you can now produce presentation-quality, photo-ready color graphics. The packet contains a selection of eight 6 x 9-inch self-adhesive color film sheets that allow you to see

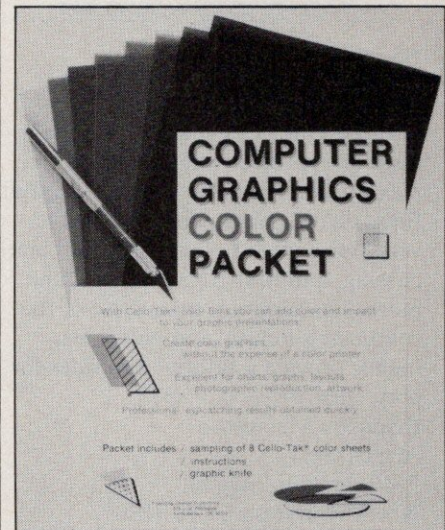

The Computer Graphics Color Packet enables you to produce photo-ready color graphics using a Macintosh and a black-and-white printer.

your graphic through the color. The durable transparent films blend with one another and with colored papers and color ribbons to produce a graphic that you can reproduce on a color Xerox or make into a slide or print. The packet also contains a knife and full instructions for use. (List Price: \$15)

**Requires:** Macintosh  
 Channel Productions  
 315 1/2 West Pedregosa Street  
 Santa Barbara, CA 93101  
 (805) 569-0034

CIRCLE READER SERVICE NO. 569

Please call for **FREE catalog** and **CURRENT LOW PRICES!**

**1-800-548-8244** (Order Line)  
**312-810-0037** (Customer Service, Product Information & Illinois Orders)

**Hours: Mon - Fri 8:30 - 5:30, Saturday 10 - 4**

Check, money order, Visa, MasterCard or American Express (include # & exp. date). \$2.50 shipping & handling in Continental U.S. (Alaska, Hawaii & foreign add 5%, min. \$5.00). Personal/company checks allow 2 weeks. Please add 2% for credit card use. Illinois residents add 6.25% sales tax. School & corporate P.O.'s welcome. Dealer inquiries invited. Prices subject to change.

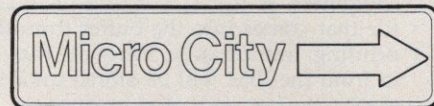

CIRCLE 115 ON READER SERVICE CARD



► **COMING UP**

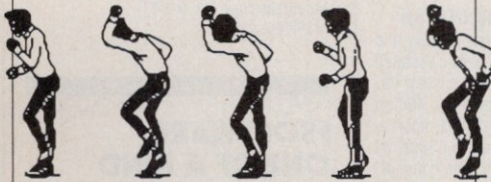

Summer Fun with Your Apple

Hardware:

Ile Enhancements  
Dot-Matrix Printers  
Projects and Tips for the  
Imagewriter

Software:

Messaging Systems

Programming:

PostScript, Part III  
ProDOS, Part IV

Entertainment:

Suspect  
MacVegas  
Typing Intrigue  
Kampfgruppe  
Felony

Macintosh Family:

Mouse Mates  
Thunderscan  
Electronic Pasteup  
Speeding Up Your Macintosh  
MacPaint Pals  
Public-Domain Software

# BACKUP PROTECTED SOFTWARE with COPY II PLUS™ ver. 5

From the team who first brought you **COPY II PLUS** in 1981 comes a completely updated disk backup utility for your Apple // computer. New features include:

- **Fully automatic bit copy\***. All parameters are stored on disk. Simply type in the name of the program you wish to backup, and **COPY II PLUS** does the rest!
- **New utilities** including Alphabetize Catalog, Fast 2-pass Disk Copy on a //c or //e, and an all-new Sector Editor.
- **Supplied on a standard DOS** diskette. Runs on the Apple //, Apple //+, Apple //e, Apple //c. Requires 64K and one or two disk drives.

Increase the power of your Apple //...  
Use **COPY II PLUS™ 5.0**

Call M-F 8-5:30 (W. Coast time) with your : **503/244-5782**.  
Or send a check (add \$3 s/h, \$8 overseas) to

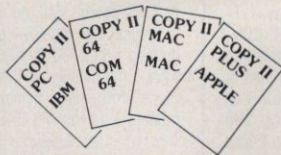

**\$39.95**

**CENTRAL POINT  
Software, Inc.**

9700 SW Capitol Hwy. #100  
Portland, OR 97219

\* We update Copy II Plus regularly to handle new protections; you as a registered owner may update at any time for 1/2 price! (To update, just send original disk and \$20.)

*This product is provided for the purpose of enabling you to make archival copies only.*

CIRCLE 185 ON READER SERVICE CARD

# GIVE YOUR PRINTER A FACELIFT.™



FACELIFT works with your APPLE II, Ile and II+ to set as many as 92 type faces, sizes and styles on the EPSON MX (with GRAFTRAX), RX and FX Printers, and their compatibles (like Star, Okidata and Smith Corona). 416 different faces, sizes and styles on the EPSON LQ-1500.

There's nothing to learn. Just call up the menu, push a typing key, and the printer is set to the face you've chosen.

From Word Processing to Spreadsheets, FACELIFT® will give you lots of the things you bought your printer for.

**GET YOUR PRINTER'S WORTH.**

**Please Send Me a FACELIFT!**

**Here's my \$29.95** Plus \$2.50 POSTAGE & HANDLING (\$32.45 TOTAL)

(California Residents add 6.5% Sales Tax)  
PHONE ORDERS (213) 696-8739

MasterCard

Visa

Check, M.O.  
(Make payable to Companion Software, Inc.)

Name \_\_\_\_\_

Address \_\_\_\_\_ Tel ( ) \_\_\_\_\_

City \_\_\_\_\_ State \_\_\_\_\_ Zip \_\_\_\_\_

Signature \_\_\_\_\_ Date \_\_\_\_\_

Acct # \_\_\_\_\_ M.C. Interbank # \_\_\_\_\_ Exp. Date \_\_\_\_\_

Specify Computer Make and Model \_\_\_\_\_

FACELIFT, P.O. BOX 4339, WHITTIER, CA 90607

A+

CIRCLE 303 ON READER SERVICE CARD

## ▶ACCESSORIES/ SUPPLIES

### COLOR AND TRANSFER RIBBONS

\$9.00 each red, blue, brown, purple, yellow, green or black for Imagewriter and Apple DMP. Transfer graphic design with electric iron to T-shirts and so forth with heat transfer ribbons \$12.00 each black. Heat transfer ribbons soon to be offered in colors. Please order in twos, any mix. Check/Visa/MC P. SHARP COLOR  
578 Lynwood La.  
Lancaster, OH 43130

### IMAGEWRITER CASES

Take your small or wide carriage Imagewriter with you in style. Computote offers weatherproof, padded cases with plenty of room for paper and supplies. Special introductory offer: Imagewriter, Now \$55.21, Wide carriage Imagewriter, now \$63.71, Macintosh, now \$84.95. Visa/MC or COD.

COMPUTOTE  
PO Box 953  
Naperville, IL 60566  
Toll Free 1-(800) 323-2748

### DISKPAC 3.5

A unique carrying case for 3 1/2 inch disks. DISKPAC 3.5 organizes and stores up to 6 disks and folds into thirds, making it small enough to fit into a suit pocket or briefcase. The case is made of nylon with velcro closure and comes in black or navy. Custom silkscreening and colors also available. List price \$14.95.

edTech  
108 N. Cassady Rd.  
Columbus, OH 43209  
(614) 885-1985

### 3 1/2" SONY DISKS FOR MAC

For awhile, SONY diskettes were not available for retail. THEY ARE NOW!! We are now introducing these diskettes at a special price of \$29 per box of ten. If desired, you can choose either blue or beige. All in stock. Please send \$29 plus \$3 for handling/shipping. (CA residents add state sales tax) send to:

PBI Software  
1155 B-H Chess Dr.  
Foster City, CA 94404  
(415) 349-8765

### CATHODE RAY TUBES

The best replacement tube on the market today is called "ORANGE DROP". Reduces eye fatigue and strain. 1 year warranty. Money back guaranteed. Available in 5", 7", 12 and 14". Fits 95% of all monitors and terminals. Used and recommended by Wyse and Televideo. Sugg. retail: 12"-\$109/14"-\$119. Dealers Welcome.

SAS ELECTRONICS, INC.  
574 Weddell Da., Suite #3  
Sunnyvale, CA. 94089  
(408) 245-5000

## MAC PRODUCTS

Mousepad—\$9.95. Mousetrap Poster—\$4.95. Mac Trap: The Better Mousepad—\$9.95. Mouse Clean Kit—\$11.95. Mac-Visor—\$9.95. Keyboard Extenders—\$46.95 clear/\$59.95 smoke. MacStand—\$39.95 clear, \$49.95 smoke. Printer Stand \$32.95. Write or phone for free brochure!  
PERK COMPANY  
150 Commercial St.  
Sunnyvale, CA 94086  
(408) 735-1807

## ▶HARDWARE/ PERIPHERALS

### MACINTOSH-APPLE IIc

MAC BUFFER eliminates printer delay. 128-256k memory. SERIAL TO PARALLEL CONVERTERS for the IIc allow interconnection of a wide variety of peripherals. Connect of centronics compatible parallel printers, plotters, or a host of other devices. Add buffering and free-up your computer! Prices start at \$79.95.

TECHNOLOGIC SYSTEMS  
PO Box 44  
Raymond, OH 43067  
(614) 890-6960

### MOUSETRACER

Use your Mac, Iie, or Iic mouse and draw like the pros! Put cartoons, pictures, maps, etc. on the drawing board. Strap your mouse to the Mousetracer and use your favorite graphics program to trace the picture of your choice. Works like a 1:1 drafting pantograph. Send \$34.95 + \$3 UPSshipping (CA res add \$2.10 sales tax) to:  
BRIMARK INNOVATIONS  
9821 Yolanda Ave.  
Northridge, CA 91324

## ▶PUBLICATIONS

### EASY MACPAINT, MACWRITE APPLEWRITER Iie 3.3, III

Learn program or refresh your memory at a glance. Save time! Reference sheets summarize, condense, explain commands. WPL, Apple DM printer codes. MacPaint made clear, hints gathered from many sources. Why pay more? MacPaint/MacWrite send \$4.95. AW Iie DOS 3.3 or AW III (final) send \$3.95 to:

Self-Help Publications  
PO Box 1293  
Ashland, OR 97520

## ▶SOFTWARE/ DENTAL

### DENTIVISION® ON MACINTOSH™

Dentists can now, thanks to modifications on the Mac's System, access detailed information including graphics on their patient's files at the press of the mouse. Files are unlimited (subject to memory available on disk). Requirement Filevision™. \$24.95 (bank check). Airmail shipping software & manual included. (Filevision™ program not included.)  
B. MULLER  
P.O. Box 32 Postkantoor Charlottalei  
Antwerp 11, Belgium

## ▶SOFTWARE/ ACCOUNTING

### MAC ACCOUNTING

The advantage of our Accounting, Tax, and Aging programs are beyond the scope of this ad to describe. At \$29.50 per program, or all for \$75.00, the businessman or the accountant will find flexible accounting at a bargain price! Please call or write for further information.

BAGEANT ACCOUNTING SERVICES  
6200 Beach Blvd.  
Jacksonville, FL 32216  
(904) 398-3003

### PAYROLL FOR THE MACINTOSH

Will calc. weekly, bi-wkly, semi-monthly and monthly payroll. Std. deductions calculated + retained for employees w/5 custom deduction acct's. 30 Empl. on 128k, 100 on 512k. Print checks, W-2/W-3, 941 report + much more. Uses 5 method for State w/holding + needs MS BASIC, free compiled vers. when avail. \$495 + ship.  
MANUFACTURING SOLUTIONS  
3885 Industrial Ave.  
Rolling Meadows, IL 60008  
(312) 392-3765

## ▶SOFTWARE/ BUSINESS

### MOUSE POUCH MAILER

Generates 20 different forms, including postcards, trans-o-grams, labels, envelopes, self-mailers, and name badges. Features help function flowchart, list merge return addresses, common messages, and 3-way autosort. Easy to read menus and screen pictorials. Single key commands. Requires 512K. \$39.95. \$2, s/h. CO+3%.  
CK/MC/VISA.  
SOFDEX INTERNATIONAL  
P.O. Box 2419  
Longmont, CO. 80501  
(303) 678-0624

## ▶SOFTWARE/ EDUCATIONAL

### GRADEBOOK MANAGEMENT

DA POMA GB GradeBook Management for microcomputers—lets a teacher or professor record & calculate grades on a micro-computer. Some of the features are: up to 8 classes per data disk, drop lowest score in a category, trend analysis, & much more! Available for Apple II's, MACINTOSH, & Radio Shack Model 4.  
DA POMA INC.  
PO Drawer H  
Hondo, TX 78861-0240  
(512) 426-5932

## ▶SOFTWARE/ GAMES

### SOLITAIRE FOR MACINTOSH

Match your skill and luck against Klondike or Canfield, the most popular versions of Solitaire. Both games feature quality graphics and fancy score keeping that allows you to play not only against the game, but against your friends too. If you're looking for fun on the Mac, discover Klondike or Canfield. Only \$19.95 ea., \$29.95 both. Add \$2.00 shipping.  
COMPUTING CAPABILITIES  
465-A Fairchild Dr. Suite 122  
Mountain View, CA. 94043  
(415) 968-7511

## ▶SOFTWARE/ ONE OF A KIND

### ENVELOPE ART™

Put a piece of your personality into your mail. MacPaint™ your envelopes & stationery. For yourself, for gifts, or as a creative business idea. Includes blank envelopes, preprinted assortment & disk with sample designs, templates & instructions. Complete kit \$29.95 (+ \$2.10 tax NY). CK/VISA/MC. Send \$3 for preprinted envelope sample only.  
ENVELOPE ART™  
2669-3 Camelot Rd., P.O. Box 129  
Endwell, NY 13760  
(607) 754-7317

## ▶SOFTWARE/ SCIENTIFIC

### SCIENTIFIC ANALYSIS PROGRAM

A scientific and numerical analysis package designed to solve linear, nonlinear, complex, real, matrix, definite integrals, polynomials, differential equations and features high-res graphics. It selects the best curve to fit data by least squares or interpolations. It includes two disks and requires BASIC. \$38.00.  
PCA SOFTWARE  
PO Box 1231  
Arlington, TX 76010  
(817) 860-5498

### DAYTON MATH FONTS

The most complete scientific character set for any word processor. Integrals, products, tensor products, sums, etc. 4 levels of subscripting + super-scripting. Tool kits for your own functions. Free updates. Complete Greek character sets, caps and lower case, old + new characters. Ideal for languages. \$31.95.  
PLUGH, INC.  
595 Royal Springs  
Springboro, OH 45066  
(513) 748-2423

## ADVERTISING RATES AND INFORMATION:

Standard listings consist of a bold lead line (23 characters maximum); 7 lines of body copy (45 characters per line); 4 lines for company name, address and telephone number. \$150 per insertion—3 issue minimum. Additional charge for extra lines and company logos. Prepayment, frequency and multi-title discounts available. American Express, MasterCard, Visa accepted. Copy subject to publishers approval. Send typewritten or printed copy, reproducible logo art (if applicable) and remittance to Kathryn Cumberland, Classified Sales Manager, Ziff-Davis Publishing Company, One Park Avenue, New York, NY 10016. For additional information, assistance, or to place an order by phone, call collect (212) 503-5115.

### ▶APPLE III

#### APPLE III IS FOR ME

We have formed a central clearing house to pool Apple III software and hardware so that you, the devoted Apple III user, can conveniently locate needed products. All items are sold at substantial discounts. To order list, send \$1.00 to cover postage and handling or pick up a copy at your local AIM dealer today.

ASSOCIATION OF INDEPENDENT  
MICRODEALERS (AIM)  
3016 N. Sterling Ave.  
Peoria, IL 61604

### ▶BUSINESS OPPORTUNITIES

Personal Computer Owners  
**CAN EARN \$1,000 TO \$5,000**  
monthly selling simple services performed by their computer. Work at home—in spare time. Get free list of 100 best services to offer. Write:  
C.I.L.B.B.  
P.O. Box 60369  
San Diego, CA 92106-8369

#### SUPPORT YOUR HABIT

Successful service-oriented distributor seeks regional sales representatives for its nationwide network. Turn your interest in computers into extra income by visiting your local computer stores once every two-three weeks. For more information write:  
Soft Rack  
2600 Keslinger  
Geneva, IL. 60134  
1-800-323-0116

### ▶HARDWARE/ COMMUNICATIONS

#### CABLE TV

Jerrold equipment including new Jerrold Tri-Mode System, Hamlin, SB-3, N-12 Mini-Code, Zenith, Z-Tac and more. All products enable you to pick-up most cable stations. Best prices around! For information, send \$1.00 plus SASE or call (312) 434-6788.

SWENSENS ELECTONICS  
6839 So. Maplewood  
Chicago, IL 60629  
NO ILLINOIS ORDERS ACCEPTED!

### ▶HARDWARE/ PERIPHERALS

#### APPLE IIc INTERFACE

Now use your Apple IIc with a parallel printer. Our SP-3 receives at BAUD rates from 300 to 19200, all switch selectable. It has a 6ft. cable and connection for another printer. \$74.95 when powered by printer. \$79.95 with wall transformer, plus \$2 shipping. Dealers inquiries invited.  
CNR ENGINEERING  
PO Box 492  
Piscataway, NJ 08854  
(201) 752-0144

#### CP/M FOR APPLE IIc

New, two CP/M packages for Apple IIc! Z80 hardware plugs inside case, can execute Z80 and 8080 codes. Compatible with all CP/M software, guaranteed for one year. \$119 Z80 package includes CP/M 2.2 RAMDRIVE disk emulation and copy software. \$230 package includes CP/M+ (3.0) operating system.

PRECISION SOFTWARE  
6514 North Fresno Street  
Milwaukee, Wisconsin 53224  
(414) 353-1666

### ▶PUBLICATIONS

#### APPLE DMP USERS IT'S HERE

Here's the book you've been waiting for. How to program your Dot Matrix printer New 100 page manual gives all printer commands in Applesoft BASIC. Great for beginners. Detailed instructions, examples, and glossary, plus 16 ready-to-run programs. \$9.95 ppd. Money-back guarantee. FREE details. For image writer, too.

TIMBERLINE PRESS  
P.O. Box 211326  
Denver, CO 80221

#### NEW! MINUTE MANUALS for

The Dot Matrix Printer	\$12.95
PDF: File/Report/Graph/Write	\$12.95
Apple Writer (all versions)	\$ 9.95

Learn quickly and easily basic and advanced procedures for your printer and software. Step by step instructions, many helpful hints. Send check, MO, Visa/MC + \$2 shipping to:

MinuteWare  
P.O. Box 2392  
Columbia, MD 21045  
(301) 995-1166

### ▶SOFTWARE/ ACCOUNTING

#### BOOKKEEPING SYSTEM

Introducing HAMS™: The One Accounts Mangr. System for the Home and Small Business. RECONCILES CR. CARD STATEMENTS & Check Books Up to 100 Accounts—Any mix of: INCOME, CHECKING, SAVINGS, CASH, CREDIT, EXPENDITURES. Default entries: HELP screens; Fully audited Det'l Rpts. + X-ref Summaries; Compl User Man Unlocked; Req. 80-col IIe; 2-drives; DM Printer \$59.95 + \$2.50 Ship; NY Res. add Sales Tax.

HILDRETH SOFTWARE, INC.  
Dept. AA  
127 Sannita  
Rochester, NY 14626

### ▶SOFTWARE/ BUSINESS

#### THE PRINT MASTER

is the COMPLETE printing disk for APPLE! Prints business (or personal) checks, mailing labels (1 or 2 across), mailing lists, addresses, envelopes and more all from file data! Has powerful sorting features, very quick set-up, menu driven throughout. Only \$34.50! Ask your dealer or write to:

SOFT-BYTE  
PO Box 5701 F. Park  
Dayton, OH 45405

### ▶SOFTWARE/ BUSINESS PROJECT MANAGEMENT

#### MOVE OVER PROJECT PLANNER

Turn sketchy ideas into actual projects & draw project graphs (in color), schedule & control projects, analyze alternatives with the powerful Critical Path Method. Uniquely visual & intuitive. Available for Apple II/II+ /IIe/IIc. DemoKit \$10. Complete product with attractive manual \$195. VISA/MC. Dealer inquiries invited.

APPLITECH SOFTWARE, INC.  
381 Harvard St.  
Cambridge, MA 02183  
(617) 497-8268

### ▶SOFTWARE/ DEV TOOLS

#### APPLE II CROSS ASSEMBLERS

Our cross assemblers permit microprocessor software development using Apple II, II+, IIe, and IIc systems. We currently have 4 cross assemblers supporting the following: 8080/85, 8048, 8051, and 68000. Each has a built-in editor and allows for complete access to DOS 3.3. Includes disk and manual. From \$60.00.

ALLEN SYSTEMS  
2151 Fairfax Rd.  
Columbus, OH 43221  
(614) 488-7122

## SOFTWARE/DEVELOPERS

### SOFTWARE DEVELOPERS

Software consultant looking for programs that run on standard Apple II and Macintosh PC's.

- Rental business management and inventory.
  - Librarian software
  - Dining room/meeting room scheduling.
- Send details and asking price to:  
**DATAMARK INFORMATION SYSTEMS**  
 Route 2, Box 31B  
 Pocahontas, IL 62275  
 (618) 654-3698

## SOFTWARE/EDUCATIONAL

### TEACHERS!

**THE ASSISTANT TEACHER** Handles almost every aspect of test preparation, administration, grading, analysis, curving, averaging and reporting. Includes word processor, optical scanner support, much more! Extremely flexible and easy to use. Satisfaction guaranteed. \$150.00: Manual \$10.00.  
**OVERDRIVE COMPUTER CORPORATION**  
 1562 Moorings Dr.  
 Reston, VA 22090  
 (703) 471-0959

### SEE THE STARS

**STAR TRACK** displays 862 stars, 8 planets, sun and moon (4 Qtrs). View the sky from any place on earth for any date of time. Locate and identify 90 constellations. A perfect accessory for a telescope. Copyrighted for use on Apple II+, Ile, Ilc (48K). Send \$34.95 (RI residents add \$2.10 sales tax) to:  
**Eskimo Software**  
 277 Turner Rd.  
 Middletown, RI 02840

### EDUCATIONAL SOFTWARE

"I thought home educational software would be dull ... but I wanted to help my child. Then I discovered your wonderful catalog with top educational software that was really fun for both of us. We really enjoy working together on our computer now. Thanks for being so knowledgeable and caring in your selections." Write or call for your own free catalog.  
**MY CHILD'S DESTINY**  
 70 Grant Avenue, Dept. 1451  
 San Francisco, CA 94120  
 (415) 861-3157

### STOP GRADING TESTS!

Let the **ASSISTANT TEACHER** handle that chore. It will prepare, print administer, & automatically grade your tests, & will record, curve, & analyze all of your course grades. Reports in any format! Includes word processor, optical scanner support, & much more. Only \$150. Manual alone \$10.  
**OVERDRIVE COMPUTER CORPORATION**  
 1562 Moorings Dr.  
 Reston, VA 22090  
 (703) 471-0959

### "MATH TRILOGY"

'ADD 'EM UP' teaches your child addition by repetition with answer correction, child's name and music. Includes graphics routines from Penguin Software's™ Cat Graphics™. 'MATH TEST' checks your child's progress in basics. Makes up grades and prints test. 'THE MATCH GAME' pits you against the computer in a game of logic. Try to win. All on one disk. Uses II+ (64K), Ile, Ilc. Ages 4 to adult. Send \$24.95 + \$1.50 P&H to:  
**D.R.C. SOFTWARE**  
 P.O. Box 152  
 Crestline, CA 92325  
 (714) 338-2936

## SOFTWARE/ENGINEERING

### BEAM ANALYSIS PROGRAM

This DOS 3.3 program rapidly and accurately calculates the reaction and shear forces, moments, slopes and deflections in beams. Perfect for engrs., students, designers etc. Program guides user through input of data. Only \$50.00: send check or MO; NY add 4%. Money back guarantee. 48k Apple II+, Ile, Ilc.  
**SYLCA CORPORATION**  
 33-47 14th Street, Dept. A  
 Long Island City, NY 11106

## SOFTWARE/GAMES

### RENT SOFTWARE FOR APPLE

WE RENT and SELL a large selection of game, educational and utility programs. Club Membership costs only \$50 (Renewal \$15/yr). Rental Period 45 Days. Most Game Rentals Only \$4. No Deposits Required as long as Rentals Don't Exceed \$8. For Full Details Send \$1 to:  
**DELSON'S COMPUCLUB**  
 19801 Vanowen St.  
 Canoga Park, Ca 91306  
 (818) 887-5260

### WIZARDRY IV AND BEYOND

Why wait for Sir-tech? Conquer the WIZIGods today! Create your very own death-dealing dungeon w/heating pools, elevators, chutes, pits, etc. Stock it with your pet-monsters, tantalizing treasure chests, & magical armor & weapons. The first COMPLETE scenario editor ever offered to the public. Why settle for just hint sheets/books? Buy **Wizards Workbench!** Introductory offer: only \$34.99!! (Send check or M.O. now.)  
**MAGICSOFT**  
 529 Farragut Place, Dept. A1  
 Danville, CA 94526  
 (415) 820-0711

### ULTIMA IV AND BEYOND

Why wait for Lord British? Conquer the EXOGods today! Create your very own perilous planet. Complete with mountains, oceans, lakes, towns, castles, & dungeons. Stock it with menacing monsters, merciful mortals, & devious demons. Probe Exodus from the INSIDE! Our popular "LAVALITE WORLD" scenario included FREE! Whether you want to conquer a new world or create one, Exodus Construction Set is for you! The ONLY complete U3 editor! Send \$28.50 check or MO today!  
**MAGICSOFT**  
 529 Farragut Place, Dept. A1  
 Danville, CA 94526  
 (415) 820-0711

### ADVENTURE HINT BOOKS

Lost in the maze? Stuck in the swamp? Help is here! We publish all the famous original **ADVENTURE HELPERS** hint books WITH MAPS—by America's top adventure game expert—for every adventure game, old & new. Send want lists (\$6 per game, postpaid) or write for free catalog—send SASE. Phone anytime.  
**ADVENTURE HELPERS—Dept. JS**  
 360 West Pleasantview Ave.  
 Hackensack, NJ 07601  
 (201) 646-9168

### PSYCHOSPHERE

Interactive space text adventure game. Truly an experience for the enthusiast. As the puzzles are solved, an exciting story of galactic evil unfolds. The mind is essential to defeat the ancient aliens. Who are the **PSYCHONIANS**, **THRALL**, and **The WATCHERS?** Apple II, Ile, Ilc, 64K and single disk drive. \$39.95 + \$2.00 S/H. (FL + 5% SALES TAX.)  
**SOFTWARE UNLIMITED**  
 PO Box 6361  
 Clearwater, FL 33518  
 (813) 797-7815

### WAR, WIZARDRY AND ULTIMA

With **Ultimore** & **Wizimore** adventures, boredom is over. Explore new places, fight new foes. Wiz fans have **SCARLET BROTH-ERHOOD**, for use w/proving grounds. OUR **ULTIMORE** adventures are famous for their creativity. Choose from **DIVIDED WORLD**, **EGYPT**, **SPACESHIP CRASH** & others. Both kinds \$20, any 3 for \$50. Free catalog!  
**BACKSTREET SOFTWARE**  
 7929 Townsend Ave., Dept. A+  
 Des Moines, IA 50322  
 (515) 278-2503

## SOFTWARE/GENERAL

### SOFTWARE EMPORIUM!

3 big reasons to buy software from **Soft Source-R Inc.**

1. Top Apple Programs, IBM Programs
2. Games, educational, small business (20-40% off)
3. Free shipping!

Write for free brochure. Specify computer.  
**THE SOFT SOURCE-R INC.**  
 P.O. Box 2931 Dept. H  
 Joliet, IL 60434

### LOW PRICES QUICK DELIVERY

**Mocking Board A \$75 Print Shop \$33 Copy II+ \$27 Newsroom \$35 Microsoft Word \$129 Helix \$265 Sargon III \$35.** We carry business, Education, Recreation, & Utility programs. Request our free Education, Business or General catalog; for all 3 send \$1 for postage. We bring prices down to Earth. Call or Write:  
**SOFTWARE SHUTTLE**  
 BOX 316  
 DAYTON, OH 45409-0316  
 (513) 293-2594

## SOFTWARE/GRAPHICS

### PASCAL PROGRAMMERS

Pascal based programs for Apple II series. Full color character set editor, \$15.00. Full color graphics editor (plus above), \$35.00. animator uses 128K add-on memory card to store and show HUNDREDS of pictures (plus above), \$50. Fully compatible with Pascal and Turtle graphics. Send for free descriptions.  
**MICRO-DATA of CHAPEL HILL**  
 PO Box 92  
 Chapel Hill, NC 27514  
 (919) 967-2764

## SOFTWARE/HOBBIES

### RUNNER'S RECORD

Records and displays races, daily runs. Automatically calculates pace; PR pace and time; average pace and time; weekly, monthly, yearly totals. Graphs race improvements, weekly distance. Prints files. Apple II+//e/c/, 64K. \$29.95.  
KNS SOFTWARE  
PO Box 9777  
Denver, CO 80209

### COIN COLLECTORS!

Unique program records entire collection and produces various reports that serve for personal investment information. Built-in market value file provides latest prices for 1600 U.S. coins. Requires 48K/1 drive/printer.  
COINS software & manual \$95 (Demo Preview-pack only \$15). VISA/MC OK. Quarterly COINS value update diskette only \$25.  
COMPU-QUOTE  
6914 Berquist Avenue Suite 101A  
Canoga Park, CA 91307  
(818) 348-3662

## SOFTWARE/ONE OF A KIND

### TEST/IMPROVE YOUR ESP

ESPWARE will test and improve your extra-sensory capabilities with numbers, colors, and shapes, rates and records your abilities in remote viewing, clairvoyance, telepathy and psychokinesis. Very easy to use. For Apple II//II+//c/e & compatibles. Send \$34.95 plus \$2 P&H. (CA res add \$2.25 sales tax) to:  
JMG ASSOCIATES  
762 Knoll Dr.  
San Carlos, CA 94070

## SOFTWARE/PERSONAL

### KITCHEN PLANNER

Create a 1-14 day Menu and Shopping List in less than 5 min. The only program available which both composes balanced meals and lets you change them! It's also the fastest and easiest to use. Compact, useable printout. To order send \$29.95 + \$1.50 (handling) or call with VISA/MC. All Apple II's. CA add 6 1/2%.  
SAV-SOFT PRODUCTS  
PO Box 24898  
San Jose, Calif. 95154  
(408) 978-1048

## FULL SERVICE CHECKING

Relax now because your checkbook is in order! G.D.S. Checking Account System makes it easy! Know where your \$ go when you categorize checks, print/display deposits, check entries and categories. Transfer to/from category, running balance, even reconciles! Easy to use Menu driven. Apple IIe, 64K, DOS/Applesoft, 1-2 disk dr., parr. printer. \$48.95. For more information or to order, write:  
GLEN DAVID SYSTEMS CO.  
PO Box 420043  
Houston, TX 77242

## SOFTWARE/REAL ESTATE

### PROPERTY MANAGEMENT

Software for rental income producing properties. Provides cash flow analysis, records expenditures on each unit, and accumulates cost for tax purposes. Prints cash flow report and Summary of Operations report. Provides depreciation and amortization schedules and print outs of each report.  
TOMAR PRODUCTIONS  
P.O. Box 740871, Dept. A  
Dallas, TX 75374  
(214) 750-1212

## SOFTWARE/SCIENTIFIC

### STATISTICAL ANALYSIS

AIDA: Apple Interactive Data Analysis. For professional survey or other statistical research. Full range of analysis, from descriptive stats through multiple regression. Handles data transformation, weighting, missing data. Up to 4,000 cases and 254 variables per file. DOS 3.3 and SOS versions. \$235.  
ACTION-RESEARCH N.W.  
11442 Marine View Dr., SW  
Seattle, WA 98148  
(206) 241-1645

## DATA ACQUISITION SYSTEM

The ISAAC 41-A and 91-A data acquisition and control systems turn your Apple II+ and IIe into a scientific or industrial workstation. Systems offer modular expansion: 4 to 512 channels of A/D, 4 to 16 channels of D/A, 16 to 128 binary I/O lines. ISAAC LabSoft makes programming easy with real time data acquisition and graphics extensions to Applesoft.

# ISAAC™

CYBORG CORPORATION DEP. P-4  
55 Chapel Street  
Newton, MA 02158  
(617) 964-9020

## SOFTWARE/SECURITY

### PROTECT YOUR PRODUCTS

SENTRY is a sophisticated easy-to-use disk duplicating system that provides both effective "in memory" protection and state-of-the-art protection against unauthorized nibble copy programs. If the end user tries to interrupt the protected program with RESET or CONTROL-C with the intention of listing, cataloging, or saving, then the protected program is automatically cleared from memory before it can be "captured." SENTRY includes a manual with programming suggestions to increase security. (List price \$250). Requires: Apple's DOS 3.3 operating system, 48K RAM, two disk drives.  
SENSIBLE SOFTWARE, INC.  
210 S. Woodward, Suite 229  
Birmingham, MI 48011  
(313) 258-5566

## SOFTWARE/UTILITIES

### DISK LABEL PRINTER

Print labels for DOS3.3, ProDOS, CP/M and Pascal disks—all files including ProDOS subdirectories. Prints 36 files/label on most Dot-Matrix printers, 52 on Epsoms. The FILE CATALOGER merges, sorts, edits and will print lists of up to 450 files from the DISK LABEL PRINTER. \$35ppd (included 100 labels, SH)  
HARDSOFT PRODUCTS  
P.O. BOX 90012  
HONOLULU, HI. 96835

## SOFTWARE/WORD PROCESSING

### FORM LETTERS; MAILING LISTS AND LABELS

generated quickly and easily with COMPANION Word Processing program: Menu-driven, simple to use. Runs on IIe or IIc. Requires Apple Writer II. \$29.95 + \$1.00 postage. Calif. residents add 6% sales tax. Specify DOS 3.3 or ProDOS version. MC-VISA.  
COMPANION SOFTWARE  
1956 McCollum Street  
San Luis Obispo, CA 93401  
(805) 544-4984-Evenings

### DON LANCASTER'S TOOLKITS

Sixteen disk sides chock full of APPLE-WRITER™ goodies: patches-source-code—microjustify—proportional space—disassembly script—answers—two columns—keyword indexing—space on disk—self-prompting glossaries—bonus book—bunches more. DOS 3.3 or ProDOS kits, \$39.50 each, \$59.50 for both.  
SYNERGETICS  
Box 809-A+  
Thatcher, AZ 85552  
VISA/MC ACCEPTED  
(602) 428-4073

## PC BUYERS GUIDE

THE INDEPENDENT GUIDE TO PRODUCTS AND SERVICES FOR IBM Personal Computers. This master directory lists, describes, rates for ease of use, and tells you about the latest in software, hardware, accessories, supplies, books, services, et al. Everything for you and your IBM PC. It even includes an Index of Computer Camps for both adults and children. From the publishers of PC. An ideal gift at only \$7.95 (+ \$1.55 shipping/handling) to U.S. destinations; and \$11.00 elsewhere. Residents of CA, CO, CT, DC, FL, IL, MA, MD, NJ, and NY add applicable sales tax. Checks or MasterCard or VISA acceptable (with number, expiration date and signature). U.S. funds only. Mail to:  
PC BUYERS GUIDE  
CN 1914  
Morristown, NJ 07960

## SUPER Z-80 CARD

- Compatible with all CPIM software.
- Executes Z-80, 8080, 8085 instruction sets and supports Z-80 interrupts.
- Runs on Apple II, II+ or IIe with or without an 80 column card.
- Low power consumption with fast clock.
- BEST OF ALL THE PRICE IS \$89.95**

## SUPER RAM CARD

- 64K upgradable to 128K
  - 80 col. built in
  - Fully apple compatible
  - Supports DOS 3.3, PASCAL, Pro Dos and CP/M
  - Can be used as an electronic disk drive
- Super Ram 64K upgradable —\$149.95  
Super Ram 128K —\$229.95

All boards are made in the USA and carry up to a 7 year warranty C.O.D. or send check or money order to

**TRICON INDUSTRIES INC.**  
3000 W. MacArthur Blvd. 6th Floor  
Santa Ana, CA 92704  
(714) 966-6711

CIRCLE 600 ON READER SERVICE CARD

## PROGRAMMERS

HAVE YOU EVER ASKED YOURSELF THESE QUESTIONS?

- How good is my software?
- How can I improve it?
- Who might be interested in it?
- How can I protect my ideas?
- Can I market my product myself?

Now there exists for the first time an opportunity for you to find out the answers to these questions

We will:

1. Critique your program on 25 key points.
2. Provide constructive comments/suggestions for improvement.
3. Provide a list of 10 possible sources that may be interested in the type of program you have developed.
4. Provide suggestions to protect your ideas from theft.
5. Provide ideas for the marketing of your product.

Submit your disc(s) and documentation together with a check or money order made payable to:

**SOFTWARE REVIEW, INC.**  
409 Dennis Drive, Absecon, NJ 08201

PER DISC \$100  
with DOCUMENTATION ADD \$50  
Please allow 4 to 6 weeks for response.

CIRCLE 601 ON READER SERVICE CARD

Introducing Wizard  
Operating System II

Imagine an operating system that...

- ..... magically expands your storage area on the disk to 139K
- ..... includes its own text editor
- ..... is so simple the program serves as its own manual
- ..... allows economical one sector file storage and does it all with one key commands

Apple II, Apple II+, Apple IIc, Apple IIe  
**Wizard Systems, RR 1, Box 246**  
Bloomfield, IN 47424  
Phone — 812 825 7802

CIRCLE 603 ON READER SERVICE CARD

## \* IIE KEYPAD \*



Our keypad features 4 programmable keys, 4 math function keys (+, -, /, \*), and 4 cursor keys, plus delete and return. **All this for only 149.00.** Non programmable models also available for only 99.00 plus 2.50 shipping.

## APPLETECH

9817 "N" Bissonnet  
Houston, Texas 77036

(713) 271-0143

CIRCLE 604 ON READER SERVICE CARD

## FREE DISKETTES

BUY ONE (1) PROGRAM  
GET (1) FREE DISKETTES

APPLE DOS 3.3 and  
IBM PC DOS PROGRAMS

DATABASE REPORTER	\$ 99
FAMILY MANAGEMENT	\$ 89
CLIENT MAIL LIST	\$ 79
CHECK BOOK REGISTER	\$ 69
STUDENT STUDY PROGRAM	\$ 59
HOME INVENTORY	\$ 49
REPORT WRITER	\$ 59
FILE WRITER	\$ 59
ADVENTURE WRITER	\$ 49
MODIFIABLE DATABASE	\$ 79
EASY DATA MODEM	\$ 299
300/1200BAUD	

ASK ABOUT OUR FREE  
ELECTRONIC MAIL BOX  
(714) 380-9437  
TELEX: 6502502780

SOFTWARE  
4418 E. CHAPMAN AVENUE STE 156  
ORANGE, CALIFORNIA 92667  
CHECK/MONEY ORDER/VISA/MASTER CARD  
SHIPPING \$3.00/PRICES SUBJECT TO  
CHANGE WITHOUT NOTICE/CALIFORNIA  
RESIDENTS ADD 6% SALES TAX  
FREE DISKETTES VALID ONLY WITH  
COUPON//24 HOUR SERVICE

## P.F.S.\* Users, Time is Money!

Your entire program can run  
2½ times faster with our  
**New Speedup System!**

\*trademark, Software Pub. Co.



P.O. Box 2342  
Santa Barbara, CA 93120  
805 569-3132

NOW USE BOTH SIDES  
OF YOUR DISKETTE!

## 5¼" DISKETTE HOLE PUNCH

WITH HOLE GUIDE

and EDGE GUIDE

PUNCH OUT IS ALWAYS IN THE RIGHT POSITION  
Available for IMMEDIATE Shipment

only \$10.00 add \$2.00 shipping  
CHECK OR MONEY ORDER

FOR OTHER THAN APPLE AND APPLE LOOK-A-LIKES-  
WE HAVE A TEMPLATE TO POSITION A REGULAR  
ROUND HOLE PUNCH FOR THE READ ENABLE HOLE  
NEAR THE CENTER

COST - 4 for \$200

**N.P.S. Inc.**  
Dept. A+  
1138 BOYWOOD RD. JENKINTOWN PA 19046

(215) 884-6010

SONY®  
**3 1/2"**

## MICRO DISKETTES

Single Side \$3.60  
Double Side \$4.85

Shipping and Handling \$3.00

ILL. RES.

Add 7 SALES TAX.

INFORMATION AND INQUIRIES

1-(800) FLOPPY 3

Phone for our 100+ Price

SONY is a registered trademark of SONY Corporation

Save on  
top quality  
3M Diskettes



5¼" SINGLE SIDE \$177  
DOUBLE DENSITY  
SOFT SECTOR

5¼" DOUBLE SIDE \$239  
DOUBLE DENSITY  
SOFT SECTOR

SOLD IN BOXES OF TEN ONLY

3½" 3M diskettes are also available

tremendous selection of software  
books, accessories and supplies  
UP TO 50% OFF!

Software for Apple  
AFC Express Pro . . . 89 Think Tank Apple . . . 87  
dBase II . . . . . 299 Think Tank Mac . . . . . 89  
Multiplan Macintosh 129 Wordstar . . . . . 189  
PFS File/Report Mac 119 Wordstar Pro Pac . . . 249

ABOVE SOFTWARE AVAILABLE IN OTHER FORMATS. CALL FOR AVAILABILITY AND PRICE.  
Minimum shipping and handling \$2.00. California residents add 6% sales tax.  
Prices subject to change without notice. Write for our free catalog.

## ABC data products

3311 ADAMS AVE, SAN DIEGO, CA 92116  
619-283-5488 800-854-1555

CIRCLE 605 ON READER SERVICE CARD

## THIS AD IS TOO SMALL

To give you more than a hint of how much we can help you be more successful with FRP games—but we'll try!

**ALL WIZARDRY (R) PLAYERS NEED THE WIZSYSTEM (tm):** Huge new manual with complete charts, great tips, step by step help. IBM (\$10), Apple (all 3 games \$15). SUPERIOR maps \$5 (Sc. 1, 2 or 3). All \$13.50 (IBM), \$25 (Apple). The WIZMASTER (tm) disk prints/modifies characters from all 3 games AND is but \$17.50! All above + WIZINEWS (tm) only \$47.50 (Apple), \$37.50 (IBM). Ask about Scenario 4!

**ULTIMA FANS NOW HAVE QUALITY HELP with the ULTISYSTEM (tm)!** Manual includes powerful tips, full charts, maps for both II and III—Only \$15! The ULTIMASTER (tm) disk alters/prints for II and III, \$17.50 (Apple, IBM, C-84). Both only \$27.50, with WIZINEWS (tm) \$35! Game IV soon!

**ALL FANTASY/ADVENTURE PLAYERS NEED THE WIZINEWS (tm) quarterly!** THE source for news, articles, gossip, tips, interviews, reviews of your favorite computer games! Subscribe. \$10/4 issues. Sample \$3.

**GAME MASTER'S GUIDES (tm)** help you creatively design and run FRP games FAST! GM I: Combat tables/Dice/Random Functions/8 more Utilities AND STORAGE for 219 Monsters, 51 Characters, 51 Treasures! GM II: Generate Troops (I-20K+); Races, Tournaments, Towns, Tricks, More! GM III: Create NEW Characters and Monsters each with Name, all Stats/Items! Warring Armies, more! Disks for Apple, IBM, C-84 \$25 each, 2 for \$47.50, all 3 only \$70!

**GM ADVENTURE I: RAPMORTH'S HOLLOW:** Exciting new concept in computer aided group FRP games! Complete with maps and detailed manual, its creative depth, richness & ease of use will add a new dimension to your gaming enjoyment! Disk for apple, \$35. New scenarios, computers soon!

Available at quality dealers or from Nichols services. Free support! Add 5% of cost + \$1.50 for S&H to US & APD. Payment: check, MO, COD, VISA/MC (US funds only-no cash).

*nichols services*

6901 Buckeye Way, Columbus, GA 31904  
(404) 323-9227

CIRCLE 606 ON READER SERVICE CARD

## Low, Low Prices Apple Peripherals

5A Switching Power Supply	\$59.95
Z80 CP/M Card	\$49.95
80-Column Card W/Soft Sw. & Inverse	\$69.95
Parallel Printer Card	\$59.95
Numeric Keypad for Apple IIe	\$99.95
The FunPad - Graphic Tablet + Joystick	\$69.95
High Quality Joystick	\$16.95

## FREE CATALOG

Hundreds of MONEY SAVING Software, Hardware and Accessories for your

### APPLE II/IIe

#### BETTER PRODUCTS, INC.

765 S. State College Blvd., Suite E

Fullerton, CA 92631

Tel: (714) 526-7923

Please add 5% for shipping and insurance.

CIRCLE 608 ON READER SERVICE CARD

# REACH OUT TO YOUR BEST PROSPECTS FOR LESS!

Whether you're a retailer, manufacturer, dealer or distributor, you need current microcomputer mail-order prospects on a regular basis, month after month. And you can have them at reasonable cost—when you place a classified ad and/or directory listing in the computer publications below.

**A+ • Creative Computing • Digital Review • PC • PC Tech Journal**

**Pinpoint the microcomputer mail-order market you want with any one or a combination of our magazines!**

Your ads are seen in high quality editorial environment, and benefit from extensive pass-along readership resulting in top-notch responses! Phone us now for rates, sizes, and ad options by title, and insert your ad in time for the next issue!

**Classified Advertising**  
**ZIFF-DAVIS PUBLISHING COMPANY**

Computer Publications Division

## CALL 212-503-5115

## COMPUTER T-SHIRTS

FOR HOME, SCHOOL, AND OFFICE!



The ULTIMATE Software! MUST for all computer lovers!

BRIGHT GREEN (LCD) LETTERS CUSTOM SILKSCREENED ON 50/50 BLEND

— HIGH TECH DESIGN! —

Five popular styles to choose from

Order Today! Only \$8.95 p/d

Made in U.S.A. Simply select shirt and color below

LET'S SEEK PEEK & PORE (#1): White #1 Pink #2 Blue #3

TAKE A BYTE OUT OF ME (#2): Green #4 Grey #5 Red #6

IM USER FRIENDLY (#3) Black #7

HAPPINESS IS A PROGRAM THAT WORKS (#4)

I ♥ COMPUTERS (#5) CUT SIZES S-M-L-XL

Please send me: \_\_\_\_\_

Shirt # \_\_\_\_\_ Size \_\_\_\_\_ Shirt \_\_\_\_\_ Color \_\_\_\_\_ Size \_\_\_\_\_

Use additional sheet if necessary

COMPUTER NOVELTY CORP

P.O. BOX 2964

FREEPORT, TEXAS 77541

Enclose \$8.95 p/d each TX Res 6% tax

NAME \_\_\_\_\_

ADDRESS \_\_\_\_\_

CITY \_\_\_\_\_ STATE \_\_\_\_\_ ZIP \_\_\_\_\_

2692

## BUY DIRECT AND SAVE FULLY APPLE COMPATIBLE

Disk Controller for 2 Drives	\$ 39.00
Epson Printer Card (Parallel) w/cables	\$ 39.00
Graphic Printer Card w/Cable (Grappler + comp)	\$ 54.00
Micro Buffer Printer Graphic Card w/32K	\$109.00
RS232 Serial Card	\$ 54.00
Super Serial Card w/Cable & Manual	\$ 90.00
16K RAM Language Card w/Cable	\$ 48.00
128K RAM Card w/Manual & Software	\$160.00
(Titan, Saturn comp)	\$ 48.00
Z-80 CP/M Card	\$ 68.00
80 Column Card w/inverse (videx comp)	\$ 78.00
Autoterm 80 Col w/Softswitch, Inverse (videx comp)	\$ 48.00
80 Column Apple IIe	\$ 78.00
80 Column w/64K Apple IIe	\$ 68.00
Epson Writer Card (2716, 2732, 2764)	\$ 16.00
Diskette Box w/Lock & Key, Holds 100	\$ 21.00
Surge Suppressor Power Center w/6 outlets	\$ 34.00
System Saver Fan w/2 outlets, lighted switch	\$ 18.00
Surge/Filter	\$ 10.00
Monitor Stand w/Tilt & Swivel	\$ 26.00
Disk Notcher w/Guide, Square Cut (doubles disk)	\$ 55.00
Joy Stick—all Metal, Heavy Duty, Fine Tuning, self centering	\$ 175.00
II/II+ \$25.00 IIe/IIc	\$ 185.00
Switching Power Supply - 5A	\$ 12.00
Slim Disk Drive-Direct Drive w/Elec Sensor Super	\$ 18.00
Quiet 1 Yr. Warranty - APPLE II/IIe	\$ 185.00
IIc	\$ 12.00
RF MOD w/Sound	\$ 18.00
w/o Sound	\$ 12.00
Shipping & Handling: Under \$100.00-10% - Over \$100 - 5%	

### COMPUTER SUPPLY

P.O. BOX 164, VALLEY STREAM, N.Y. 11582

(516) 239-1855 Hours: M - F 9-6 EST

CIRCLE 609 ON READER SERVICE CARD

## NEW! Lower Prices!!

# wabash®

lifetime warranted

## DISKETTES!

**\$9.80/box (10)**

5 1/4" single -side, single-density, double-density add \$2/box. Add \$3 per order shipping. In Illinois add 7% sales tax.

**Library Case-\$1.75** (with disk purchase)  
Immediate shipment on VISA, MasterCard or Money order; add 14 days for personal checks.

**CALL TOLL FREE**

(800) 222-1248

In Illinois Call (312) 882-8315

DEALERS! SCHOOLS! USER GROUPS!  
Call for our volume discount prices!

## DIGITAL IMAGES

1185 Tower, Schaumburg IL 60195

CIRCLE 610 ON READER SERVICE CARD

## THE BUYERS GUIDE

THE MASTER DIRECTORY OF PRODUCTS FOR THE IBM PC, PC XT, PCjr AND MOST COMPATIBLES!

AVAILABLE AT YOUR LOCAL NEWSSTAND AND COMPUTER STORE.

# A+ AD INDEX

## BY PRODUCT CATEGORY

### ACCESSORIES

	PAGE
<b>CARRYING CASES</b>	
Southern Case .....	44

### DISKS

ALF .....	88
-----------	----

### MISCELLANEOUS

Black Sun .....	147
Cheatsheet Products .....	71
Computer Cover Company .....	105
Cortran International .....	16
EMCO .....	91
MEC Enterprises .....	128
Round Lake Studios .....	146

### HARDWARE

	PAGE
<b>DIGITIZERS</b>	
Digital Vision .....	80
I/O Video .....	133
Thunderware .....	122

### DISK DRIVES/STORAGE DEVICES

Ampex .....	6-7
Corvus .....	126
Video Technology .....	18

### INTERFACE CARDS

Applied Engineering .....	C4, 39, 67, 77, 85, 87
AST Research .....	58
Carribbean Computer Sales .....	52
Checkmate Technologies .....	96
Hanzon .....	149
Interactive Microware .....	88
Interactive Structures .....	90
Legend Industries .....	160
Quadram .....	24
Thirdware .....	18
Video 7 .....	1
Videx .....	10
Wico Consumer Division .....	41

	PAGE
<b>MISCELLANEOUS</b>	
Apropos .....	148
Assimilation Process .....	98
Kensington Microware .....	14
MacMemory Electronics .....	146
Microsoft .....	55
Quoram .....	56
Street Electronics .....	5
Thunderware .....	59

### MODEMS

Bach Company .....	66
Prometheus .....	60

### PRINTERS/PRINTER ACCESSORIES

Alphacom .....	20
C. Itoh - Digital Products .....	57
Softstyle .....	123, 125, 127
Synergy Products .....	120
Texprint .....	40

### MAIL ORDER

	PAGE
Beagle Brothers .....	26-27
Business Computers of Peterborough .....	21
Byte General .....	94
CDA .....	54
Central Point Software .....	125, 151
Coit Valley Computers .....	70
Comarc .....	132
Computer Discount Products .....	68
Computer Network .....	78
Conroy LaPointe .....	33
Creative Computer Products .....	127
Desktop Software Center .....	112
Garden of Eden .....	73
I/O Design .....	113
InexSoft .....	54
Infotek .....	121
Jameco .....	92
JDR Microdevices .....	19
Nonagon .....	16
Northeastern Software .....	45, 129
Pace Systems .....	150
PC Network .....	102-103
Precision Data Products .....	70
Programs Plus .....	53
Silicon Express .....	56
Software Discounters of America .....	76
Zimco .....	62

### SOFTWARE

	PAGE
<b>BUSINESS</b>	
Allegro .....	145
Applied Software Technology .....	65
Forethought .....	108-109
Funk Software .....	46
H & E Computronics .....	C-2
Real Data .....	144
Software Publishing Corp. ....	35
Utilico .....	89

### COMMUNICATIONS

DataViz .....	145
Softronics .....	64
Software Masters .....	123

### DATA MANAGEMENT

P/M Software .....	51
Rolodex Software .....	23
Warner Software .....	107

### DEVELOPMENT SYSTEMS

Hippopotamus Software .....	115
Manx Software Systems .....	111

### ENTERTAINMENT/ STRATEGY

Activision .....	86
Baudville .....	17
Crystal Ware .....	136
PDS Sports .....	75
Penguin Software .....	8
Sir-Tech .....	82
Spectrum Holobyte .....	116
Sublogic .....	4
Videx .....	118

### FINANCIAL

Core Concepts .....	47
Dow Jones .....	137

### GRAPHICS

Altsys Inc. ....	114
I.D.D. ....	143
Manhattan Graphics .....	124
PBI .....	140-141
Spectralgraphics .....	22

	PAGE
<b>LANGUAGES</b>	
Expertelligence .....	104
Microsoft .....	117

### MISCELLANEOUS

Compucrafts .....	54
Professor Jones .....	80
Softkey Publishing .....	79

### ON-LINE SERVICES

Compuserve .....	63
------------------	----

### PERSONAL BUSINESS- HOME

HowardSoft .....	C-3
------------------	-----

### PERSONAL PRODUCTIVITY

Bible Research Systems .....	52
Organization Development Systems .....	130

### UTILITIES

Alpha Logic Business Systems .....	72
Pro/Pac .....	160
Vilberg Brothers .....	56

### WORD PROCESSING/SPELLING CHECKERS

Action Research Northwest .....	74
Companion Software .....	151
Sensible Software .....	144, 38



# ALPHABETICAL AD INDEX

READER SERVICE NO. PAGE

## A

- 153 Action Research Northwest ..... 74
- 174 Activision ..... 86
- \* ALF Products ..... 88
- 152 Allegro Software ... 145
- 328 AlphaCom ..... 20
- 259 Alpha Logic Business Systems ..... 72
- 235 Altsys Corp. .... 114
- 170 Ampex Corporation . 6-7
- \* Applied Engineering . 39
- \* Applied Engineering . 67
- \* Applied Engineering . 85
- \* Applied Engineering . 77
- \* Applied Engineering . 87
- \* Applied Engineering C-4
- 123 Applied Software Technology .... 65
- 200 Apropos Software ... 148
- 212 Assimilation Process . 98
- 323 AST Research ..... 58

## B

- 269 Bach Company ..... 66
- 156 Baudville ..... 17
- 249 Beagle Brothers . . 26-27
- 158 Bible Research Systems 52
- 160 Black Sun ..... 147
- \* Business Computers of Peterborough .... 21
- 306 The Byte General ... 94

## C

- 296 C.Itoh Digital Products 57
- 149 Caribbean Computer Sales, Inc. .... 52
- 292 CDA Computer Sales . 54
- 185 Central Point Software 151
- 184 Central Point Software 125
- 138 Cheatsheet Products . 71
- 128 Checkmate Technologies 96

READER SERVICE NO. PAGE

- 340 Coit Valley Computers 70
- 291 Comark, Inc. .... 132
- 303 Companion Software 151
- 157 Compucrafts ..... 54
- 271 Compuserve ..... 63
- 163 Computer Cover Company ..... 105
- 290 Computer Discount Products ..... 68
- 343 Computer Learning Center ..... 79
- 137 Computer Network ... 78
- 129 Conroy-La Pointe and Computer Exchange 33
- 236 Core Concepts ..... 47
- 276 Corvus Systems, Inc. 126
- 131 Creative Computer Products ..... 127
- 213 Crystal Ware ..... 136

## D

- 333 Dataviz ..... 145
- 151 Desktop Software Center 112
- 172 Digital Vision ..... 80
- 234 Dow Jones Software . 137

## E

- 239 EMCO ..... 91
- 278 Expertelligence .... 104

## F

- \* Forethought .... 108-109
- 154 Funk Software ..... 46

## G

- 265 Garden of Eden ..... 73

## H

- \* H & E Computronics C-2
- 216 Hanzon ..... 149
- 197 Hippopotamus Software 115
- \* HowardSoft ..... C-3

## I

- 168 Inexsoft ..... 54
- 286 Infotek, Inc. .... 121
- 324 Interactive Microware 88
- 274 Interactive Structures . 90
- 112 Innovative Data Design Inc. .... 143
- 162 I/O Design ..... 113
- 141 I/O Video ..... 133

READER SERVICE NO. PAGE

## J

- 279 Jameco Electronics ... 92
- 167 JDR Microdevices ... 19

## K

- 134 Kensington Microware 14

## L

- 287 Legend Industries, Ltd. 160

## M

- 132 Mac Memory Electronics 146
- 288 Manhattan Graphics Corp. .... 124
- 189 Manx Software Systems 111
- 147 Mec Enterprises .... 128
- 115 Micro City ..... 150
- \* Microsoft ..... 117
- \* Microsoft ..... 55

## N

- 237 Nibble Notch ..... 16
- 125 Nonagon Software ... 16
- 330 Northeastern Software 45
- 304 Northeastern Software 129

## O

- 327 Organization Development Software ..... 130

## P

- 140 PBI Software ..... 140
- 143 PBI Software ..... 141
- 315 PC Network ... 102-103
- 119 PDS Sports ..... 75
- \* Penguin Software ..... 8
- 150 PM Software ..... 51
- 228 Precision Data Products 70
- 148 Professor Jones ..... 80
- 299 Program Plus ..... 53
- 122 Prometheus Products . 60
- 165 Pro/Pac ..... 160

## Q

- 139 Quadram Corporation . 24
- 223 Quorum International Unlimited ..... 56

READER SERVICE NO. PAGE

## R

- 342 Real Data ..... 144
- 182 Rolodex Corporation . 23
- \* Round Lake Studios . 146

## S

- 103 Sensible Software ... 144
- 227 Sensible Software ... 38
- 231 Silicon Express ..... 56
- 260 Sir Tech ..... 82
- 164 Softronics ..... 64
- 221 Softstyle, Inc. .... 127
- 312 Softstyle, Inc. .... 125
- 313 Softstyle, Inc. .... 123
- 155 Software Discounters of America .... 76
- 196 Software Masters ... 123
- \* Software Publishing Corporation ..... 35
- 120 Southern Case ..... 44
- 107 Spectralgraphics Software ..... 160
- 109 Spectralgraphics Software ..... 22
- 233 Spectrum Holobyte . 116
- 187 Street Electronics ... 5
- 110 Sublogic ..... 4
- 310 Synergy Products ... 120

## T

- \* Texp rint ..... 40
- 106 Thirdware Computer Products ..... 18
- 226 Thunderware, Inc. ... 59
- 284 Thunderware, Inc. ... 122

## U

- 190 Utilico Software .... 89

## V

- 195 Video-7 ..... 1
- 180 Video Technology ... 18
- 142 Videx, Inc. .... 10
- 146 Videx, Inc. .... 118
- 244 Vilberg Brothers .... 56

## W

- 193 Warner Software ... 107
- 338 Wico Consumer Division 41

## Z

- 349 Zimco ..... 62

# The Legend E' Card For Your Apple //e

**64K to 1 Megabyte  
RGB Video  
16 Levels of Gray Video  
730K Appletalk Desk Top**

**NOW ALL ON ONE CARD!!!**

Turning Apples into Legends since 1981.

CALL or WRITE:

**LEGEND INDUSTRIES, INC.**  
2220 Scott Lake Rd.  
Pontiac, MI 48054  
**(313) 674-0953**

CIRCLE 287 ON READER SERVICE CARD

Set Up Your **DOT MATRIX PRINTER**  
With a Touch of a **KEY!**

## PCP™ **PRINTER CONTROL PROGRAM**

No longer do you have to enter long "set up strings" to take advantage of your DOT MATRIX PRINTER's capabilities. Just select from the MENU...let your computer do the rest! Condensed Characters, Double Strike Printing, Emphasized Characters, Special Line Spacing, and more! Comes complete with PROGRAM DISKETTE and OPERATING MANUAL. Includes information on how to program your printer in Basic, VisiCalc®, Applewriter. PCP is a very handy utility program you will use again and again!

**VERSIONS:**  
**Apple II, II+, IIe and III WITH**

**Apple DMP & Imagewriter  
Epson MX\*, RX & FX Printers  
C.Itoh Prowriter I & II  
NEC PC8023A  
Okidata 82A, 83A, 92, 93 & 84  
Gemini Star 10, 10X & 15**

**PRO/PAC**  
14925-A Memorial Drive, Dept. B  
Houston, Texas 77079  
(713) 496-1179

\* Requires Graftrax Plus™ For Full Features

### EPSON PRINTER CONTROL PROGRAM

**PRINTER OPTIONS**

A CONDENSED	G 6 LINES/INCH
B DOUBLE WIDTH	H 8 LINES/INCH
C ITALICS	I 10 LINES/INCH
D HALF SIZE	J SPECIAL SPACING
E EMPHASIZED	K UNIDIRECTIONAL
F DOUBLE STRIKE	L BIDIRECTIONAL

**SOME COMBINATIONS**

M EMPHASIZED DOUBLESTRIKE
N DOUBLEWIDE EMPHASIZED
O DOUBLEWIDE EMPHASIZED DOUBLESTRIKE
P CONDENSED DOUBLEWIDE
Q CONDENSED DOUBLEWIDE DOUBLESTRIKE
R CONDENSED DOUBLESTRIKE
S CONDENSED HALF SIZE
T RETURN TO STANDARD SETTINGS

TYPE LETTER, PRESS RETURN (0 ENDS)

**THIS IS WHAT THE EPSON MX VERSION MENU LOOKS LIKE**

Be sure to specify **BOTH** microcomputer and printer to obtain correct version.

**ONLY \$29.95**

plus \$2.00 shipping and handling USA  
VISA and MasterCard Credit Cards  
See Your Dealer or Write or Call Us!

APPLE is a registered trademark of Apple Computer, Inc.

CIRCLE 165 ON READER SERVICE CARD

# CurvePlotter!

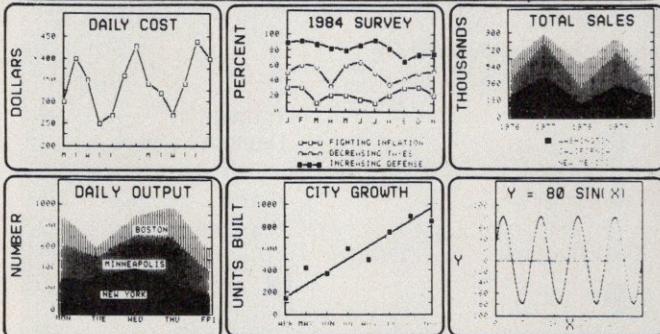

**ONLY \$29.95!** Don't pay more for less! For APPLE II+/IIe/IIc/III and APPLE-compatibles. CurvePlotter! is an extremely sophisticated chart program. It plots line charts, area charts, best-fit trend charts, and mathematical functions. Up to 100 keyboard-entered data points may be entered, stored to disk, and plotted on screen or printer. Data may be edited at any time. All labelling and scaling is automatic or user-defined. The LINE CHART, AREA CHART, and TREND CHART programs permit numerical entry versus month, year, day, or any other horizontal label the user wishes. These programs also permit entry of x-y numerical data pairs, which is perfectly suited for scientific work. The TREND CHART program is an indispensable business and scientific tool. It finds the "best fit" to a set of data, and then draws the best straight line among the data. Also on the CurvePlotter! disk is our unsurpassed SCIENCE/MATH CHART program. Just type in any mathematical function you can think of and this program will plot it!

Send a check or purchase order for \$29.95 to SPECTRAL GRAPHICS SOFTWARE, 6333 Pacific Avenue, Suite 256-A, Stockton, California 95207. We ship immediately! Satisfaction or your money will be immediately refunded (really). Call (209) 474-1212 for C.O.D. orders. CurvePlotter! is not sold in most stores.

CIRCLE 107 ON READER SERVICE CARD

# COMPLETE YOUR LIBRARY OF A+

Add to your A+ collection today. Make your personal library complete and authoritative with any issues you may be missing.

Copies are available for issues published during the last twelve months—be sure to specify the issues you want. If a particular issue is out of stock, your payment will be refunded promptly.

Back issues of A+ are priced at \$6.00 each, postpaid. Outside USA, \$7.00 each.

**A+**  
MCBI, Morristown, NJ 07960

MBIS

Please send issues of A+ listed below:

Issue	Qty.	Unit Price	Total Price
Payment Enclosed			\$

Mr./Mrs./Ms. \_\_\_\_\_ (print full name)

Address \_\_\_\_\_

City/State/Zip \_\_\_\_\_

# The Intelligent Decisionmakers

As an investor, your decisions depend on accurate, timely information.

The problem is that most of today's investment tools are based on outdated "guidelines" and unrealistic rules, so they can't give you the quality analyses you need to make intelligent decisions.

At HowardSoft™, we create software that's appreciated by both the inexperienced user and the seasoned pro. Real tools for real decisions.

## Real Estate Analyzer™

There's a terrific piece of property you'd like to get involved with. But what happens if interest rates rise, rents fall, inflation soars? HowardSoft's Real Estate Analyzer tells you with realistic projections under today's conditions.

Because HowardSoft knows taxes, your after-tax analyses of cash flow and profitability are based on real tax laws, not outdated rules.

And you don't have to be a computer whiz or a real estate expert to use Real Estate Analyzer. Well-planned menus, clear prompts, and a manual filled with examples help you get the most from the program (and your investment) and make it a veritable education in investment analysis.

## Tax Preparer™

Your taxes affect every financial decision you'll make this year. With the mid-year tax planning supplement, HowardSoft's Tax Preparer lets you predict the year's taxes using actual 1984 tax tables. You enter information as it accumulates. Then each update lets you apply the data to the new tax forms in a matter of minutes.

Tax Preparer handles changes easily, calculates quickly and accurately, and—at the touch of a key—delivers error-free printouts ready to sign and drop in the mail. With crystal clear instructions, and the most used forms and schedules, no wonder Tax Preparer is the #1 selling tax program.

## Intelligent Software

Both packages help make running your finances easier and more effective. Each works with either the Apple II series, the IBM-PC, or a select range of PC compatibles. Each does the work of software costing many times its price. And each leads the field in accuracy of information and ease of use.

Real Estate Analyzer and Tax Preparer. Intelligent investment for intelligent investors.

## HowardSoft™

The software investment  
you can count on.



8008 Girard Avenue, Suite 310,  
La Jolla, CA 92037 • (619) 454-0121

# THE AMERICAN WAY TO THE TOP

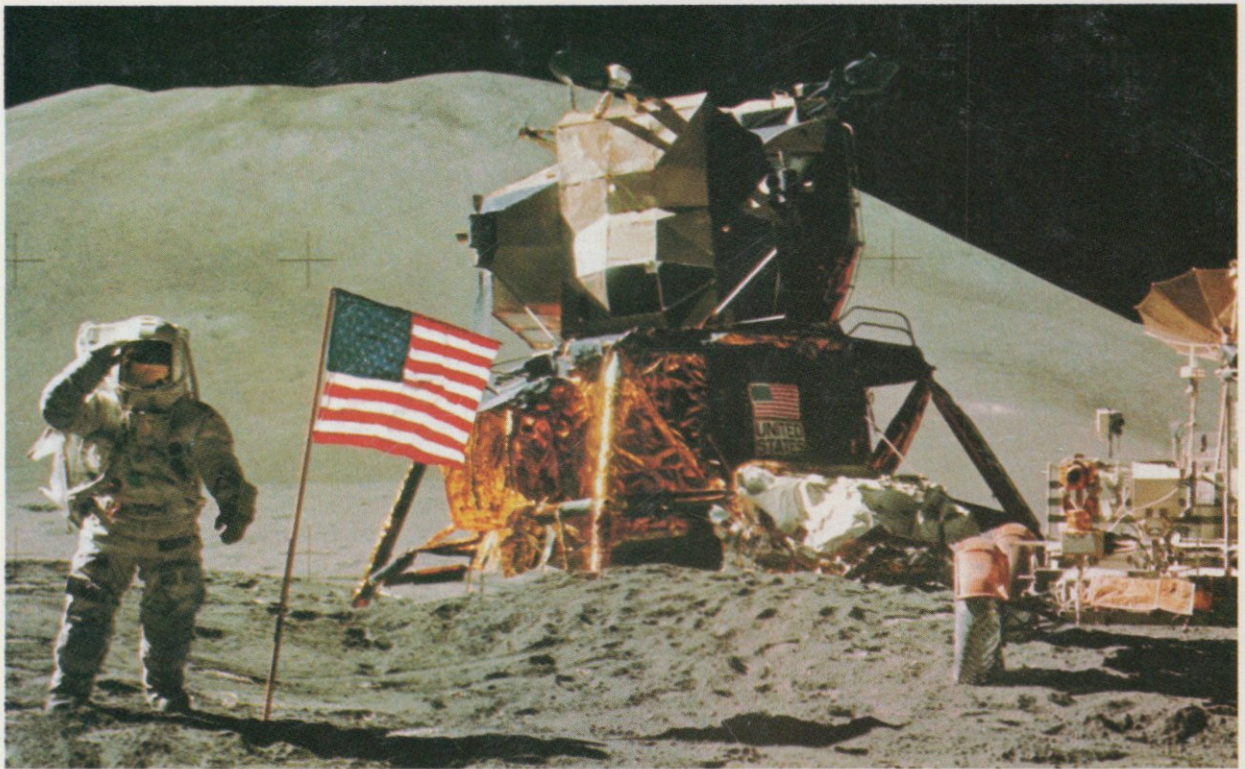

This July 4th, we at Applied Engineering hope that all Americans will take time out to ponder who and what we are.

It is hoped that we can remind ourselves what it means to be an American.

We invented the telephone, the electric light, the phonograph, and the airplane. Americans invented the first vacuum tube, transistor and the integrated circuit, without which the personal computer would have been impossible. Over 95% of the world's new inventions are invented by Americans. We lead the world in all phases of technology; electronics, physics, chemistry, health science, space and robotics. We've sent men to the moon, landed a robot on Mars, and sent our probes out across the galaxy! Americans by their very nature are inventors, thinkers, winners and doers.

America is a country where two young men started a company in their garage and three years later Apple Computer is the industry leader. Applied Engineering started much the same way and we became the leading Apple peripheral manufacturer, with no outside sales force, no marketing strategy,

and no commissioned sales people.

Our business plan at Applied Engineering is simple. BE THE BEST. That means producing tomorrow's peripherals today, it means hard work, high quality, total dedication to Apple Computer and good service at competitive prices.

While some other guys are losing the ball game . . . we're adding to our roster. In the past few months, we've added 3 new products to our line up for a total of 21 and we're working on more. We've added more order lines and more knowledgeable people to serve you.

While others look to the Orient for solutions to their engineering and manufacturing problems, we at Applied Engineering feel differently because we know America's inventive past and her inventive future and we're excited.

To quote Dr. Robert Goddard in a letter to H. G. Wells, "There can be no thought of finishing, for 'aiming at the stars,' both literally and figuratively, is a problem to occupy generations, so that no matter how much progress one makes, there is always the thrill of just beginning."



**APPLIED ENGINEERING**  
"We Set the Standard"